

RECALL 23V262 / 2023-217 REMEDY INSTRUCTIONS



Make(s): Many, See Below
Model(s): Many
Model Year(s): 2021-2023

Concern: According to Lippert Components recall 23E027: "In transit, the mounting hardware holding the solar panel in place could become loose or pull through slots in the solar panel."

Repair Code: RC-689-03-00-004329
Allotted Time: .70 HRS
Inspection Code: RC-689-05-00-004328
Allotted Time: .25 HRS.

Photo(s) Required: NO
Prior Authorization Required: NO
Part(s) Kit Number: SEE REMEDY
Part(s) Return: NO

Disconnect the vehicles' battery Positive and Negative, disconnect any House battery(s) Positive and Negative, if equipped with a generator ensure it is off and lastly, ensure the vehicle is disconnected from shore power. Block any tires/wheels to prevent the vehicle from rolling. Failure to do so may result in electrocution, fire or other personal injury, property damage and/or death.

AFFECTED MODELS

One single 2021 FR3, 2021 Forester Class C Motorhome and one single 2021 Georgetown Class A Motorhome recreational vehicles. As well as certain 2022-2023 East to West Entrada Class C Motorhomes. Certain 2023 East to West Alta, Coachmen Apex, Spirit, Travel Trailers and 2023 Coachmen Brookstone, Chaparral, Chaparral Lite, Shasta Phoenix, Crusader, Sanibel, and East to West Tandara Fifth Wheels

WAY SOLAR PANEL FIELD REWORK INSTRUCTIONS

Recall Number:	23E-027		
Product:	WAY Solar Panel		
Date:	April 13, 2023	Labor Rate:	0.7 Hours

Purpose

This document provides rework instructions for WAY solar panel mounting brackets. The corrective action for Recall 23E-027 includes installing additional brackets and hardware; the solar panel does NOT need to be removed from the unit.

NOTE: Please submit a photo of the serial tag on the top (glass) surface with completed work order/claim. If the serial tag is not present, please note this on the claim and submit without photo.



NOTE: If the solar panel has framing that is black in color (Fig. 1), there is no action needed. The VIN should be reported back to the manufacturer to remove from recall with it noted no action is required.

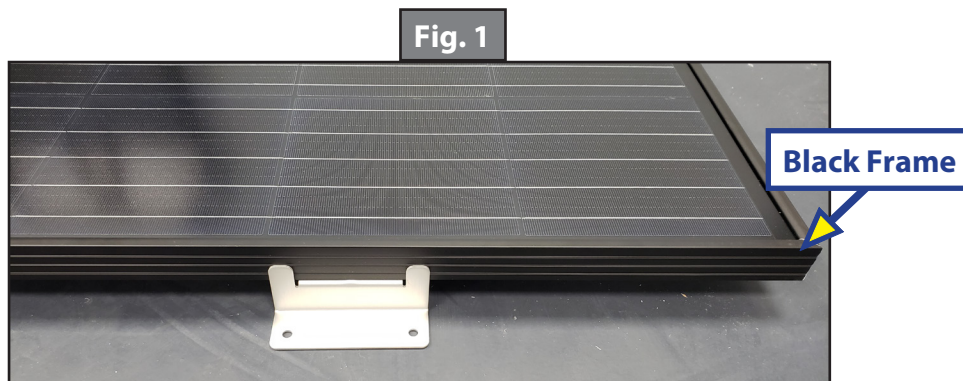

Identifying Products For Rework Kit (See Kit Information Section)

- Solar panel with a silver frame
- Two types of brackets used to mount the panel
- Dimensions of solar panels
 - 100W – 40.1 x 26.3 x 1.3 inches
 - 195W – 58.2 x 26.3 x 1.3 inches

Safety

This document provides general instructions. Many variables change the circumstances of any procedure, i.e. the degree of difficulty of the service and the ability of the individual performing the operation. This document cannot plot procedures for every possibility, but will provide general instructions for installing, removing or servicing the system. In the event the skill level required is too advanced or the procedure too difficult, a certified technician should be consulted before performing the operation. Failure to correctly install, remove or service the system may result in voiding the warranty, inflicting injury or even death.

WAY SOLAR PANEL FIELD REWORK INSTRUCTIONS

Recall Number:	23E-027		
Product:	WAY Solar Panel		
Date:	April 13, 2023	Labor Rate:	0.7 Hours

Kit Information

Solar Panel Mounting Bracket Rework Kit, PN 2023020670, can be used on all solar panel part numbers listed in the table below.

Items in the rework kit 2023020670	Quantity
Add-on L-brackets with adhesive tape	4
Spacers with adhesive tape	4
#12 thread-cutting screws	12
3/16" HSS drill bit	1

Applicable products for the rework kit		
Product Description	WAY SKU	Lippert SKU
Solar, Solar Panel, 195W with brackets installed, 106009, ET195PMP4B	106009	2022302246
Solar, Solar Panel, 100W with feet attached, 106040, ET100MP4B	106040	2022302299
Port, 100-watt 30ACC roof port w/MC-4, 7MMC-0100-K	7MMC-0100-K	2022449915
100W w/ branch connector expansion kit, 7MYE-0100-P	7MYE-0100-P	2022302362

Resources Required

- Appropriate kit as listed in the previous table
- Cordless or electric drill
- Cordless impact driver
- Metric size #8 or Imperial size 5/16" socket or nut driver

Preparation

NOTE: Lippert does not require any advance contact or prior authorization be obtained by the repairing facility.

The solar panel's SKUs mentioned may be mounted on RV units with two different types of mounting brackets shown below. This rework kit can be used for both bracket types.

1. Begin the rework process by identifying the type of bracket (A or B) used to mount a solar panel to the roof of an RV unit. Use the corresponding process shown below.



Type A

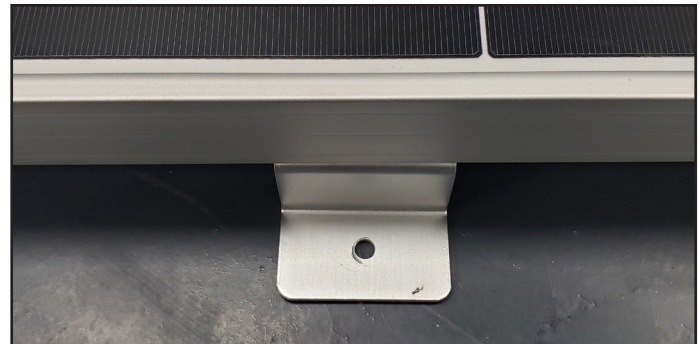

Type B

WAY SOLAR PANEL FIELD REWORK INSTRUCTIONS

Recall Number:	23E-027		
Product:	WAY Solar Panel		
Date:	April 13, 2023	Labor Rate:	0.7 Hours

Procedures

For Type A Mounting Bracket

1. Peel the adhesive backing on the small rectangular spacer piece and stick it to the add-on L-bracket centering it on the single mounting hole at the center of the bracket shown below.

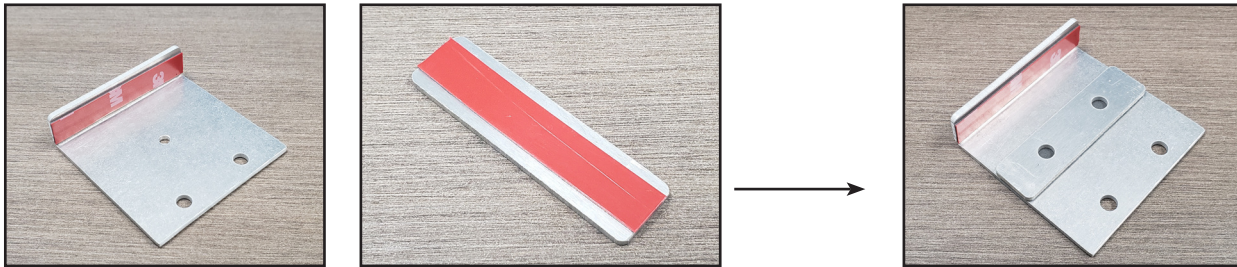

2. Peel the adhesive backing on the L-bracket and attach it to the panel, centering the add-on bracket to the pre-existing mounting bracket as shown below. Make sure the bracket is flush to the top and sides of the panel.

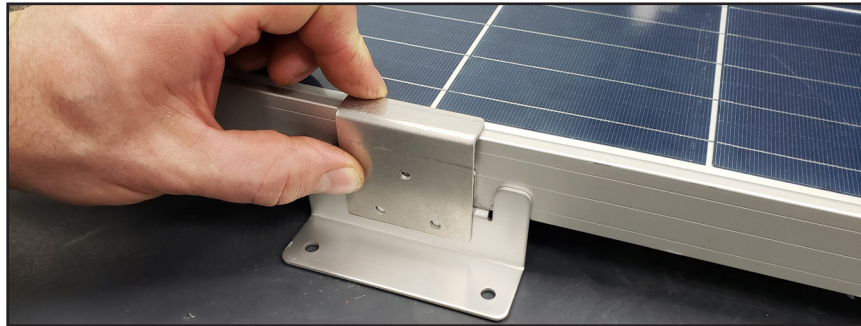

3. Drill a hole (using the 3/16 size drill bit from the kit) through the L-bracket pilot hole and the solar panel. Drill into the panel as straight as possible. Drilling at an inclined angle could result in hitting the M6 fastener of the pre-existing bracket behind the panel frame.

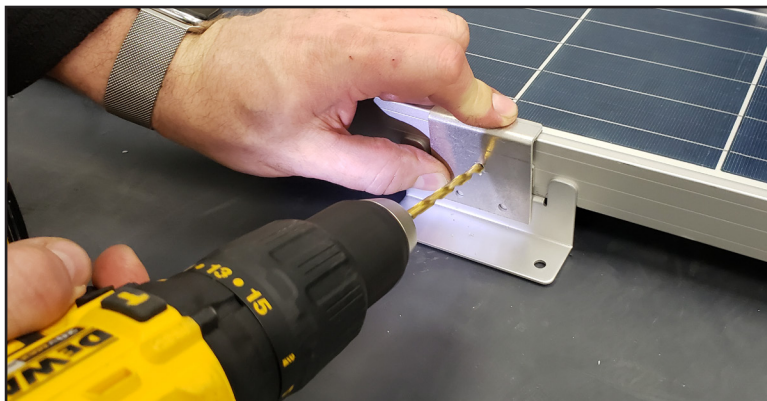

WAY SOLAR PANEL FIELD REWORK INSTRUCTIONS

Recall Number:	23E-027		
Product:	WAY Solar Panel		
Date:	April 13, 2023	Labor Rate:	0.7 Hours

4. Use the impact driver tool with the recommended socket and drive one of the #12 thread-cutting screws into the above drilled hole and secure the add-on bracket to the panel.

NOTE: Be careful and drive the screw slowly into the thin panel wall to avoid stripping it out.

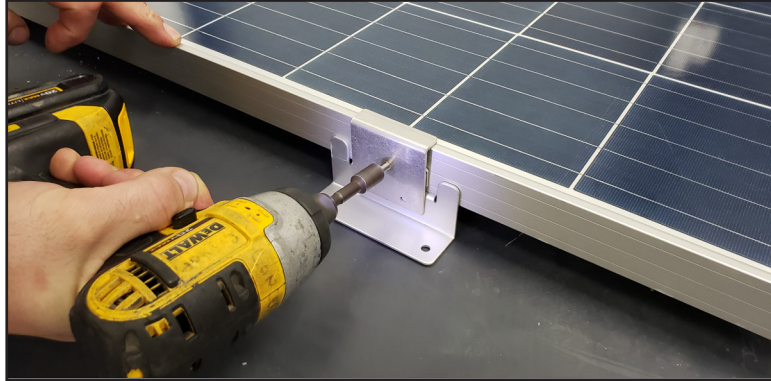

5. Drill out the other two holes on the add-on bracket and through the pre-existing mounting bracket.

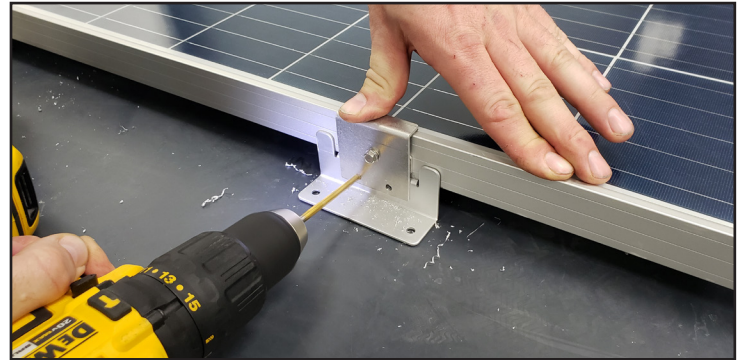
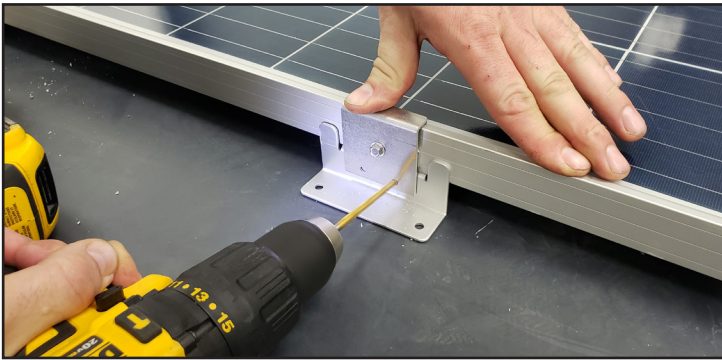

6. Drive the other two #12 screws into the recently-drilled holes and secure the add-on bracket to the pre-existing bracket.

NOTE: Be careful and drive the screws slowly to avoid stripping them out.

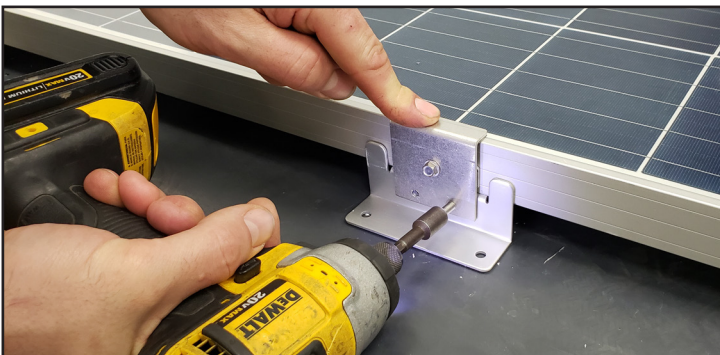

WAY SOLAR PANEL FIELD REWORK INSTRUCTIONS

Recall Number:	23E-027		
Product:	WAY Solar Panel		
Date:	April 13, 2023	Labor Rate:	0.7 Hours

- Repeat the process for the other brackets of the panel which completes the reworking process of the Type A mounting bracket.

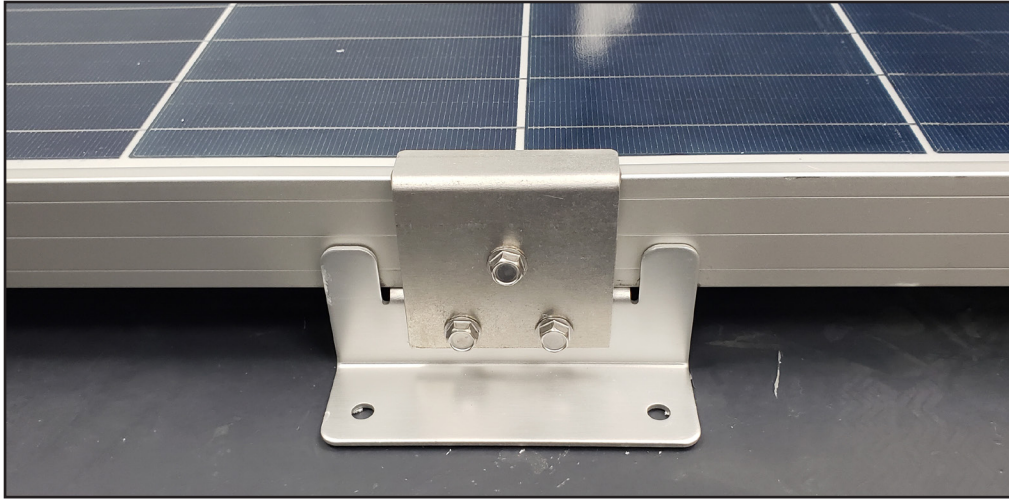

For Type B Mounting Bracket

Identify how the Type B bracket is installed on the panel. It could be flush mount or somewhat recessed or protruding out compared to the side of the solar panel.

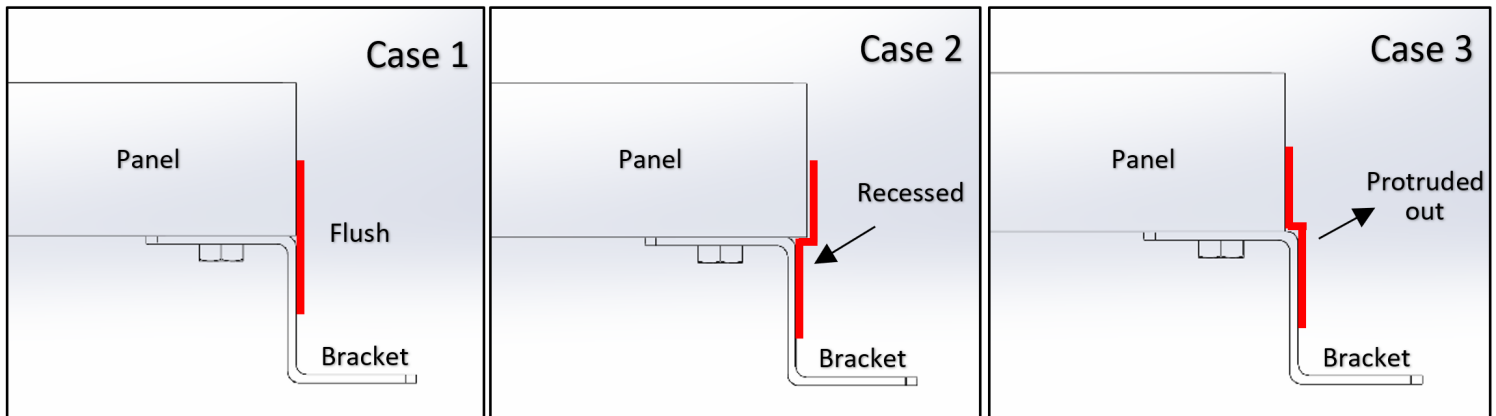

WAY SOLAR PANEL FIELD REWORK INSTRUCTIONS

Recall Number:	23E-027		
Product:	WAY Solar Panel		
Date:	April 13, 2023	Labor Rate:	0.7 Hours

Case 1: Flush mount

1. If the bracket front face is flush to the panel, then no spacer is required. Peel the adhesive on the L-bracket and stick it flush to the panel, centering on the pre-existing bracket.
2. Drill the top hole of the bracket through the panel and install a #12 screw.

NOTE: Be careful and drive the screw slowly into the thin panel wall to avoid stripping it out.

3. Follow the same process for drilling the other holes and secure the bracket with the other two screws.

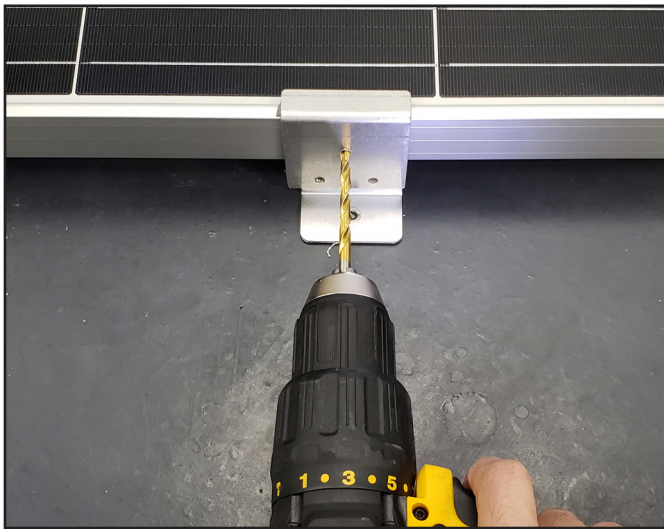

Case 2: Bracket recessed

1. If the bracket front face is recessed, the add-on bracket won't align flush to the panel and creates a gap between the add-on bracket and the pre-existing bracket at the bottom.
2. To fill the gap, stick the spacer piece using adhesive tape on the pre-existing bracket.

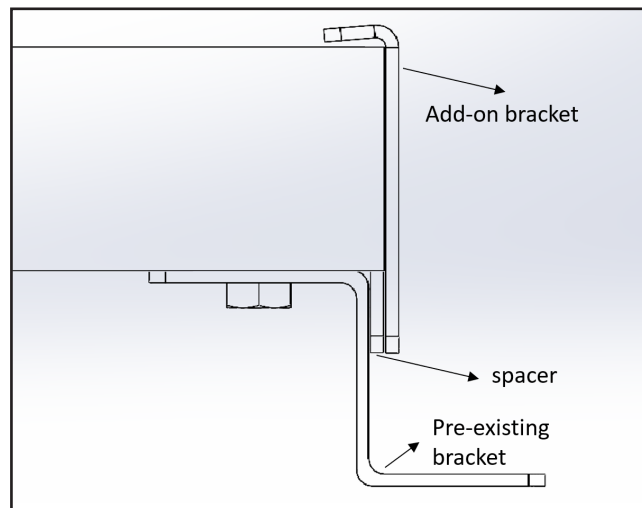

WAY SOLAR PANEL FIELD REWORK INSTRUCTIONS

Recall Number:	23E-027		
Product:	WAY Solar Panel		
Date:	April 13, 2023	Labor Rate:	0.7 Hours

Case 3: Bracket protruding out

1. If the bracket's front face is protruding out, the add-on bracket won't align flush to the panel and creates a gap between the add-on bracket and the panel.
2. To fill the gap, stick the spacer piece on the bracket as shown below. Try to center the spacer on the top hole as much as possible.

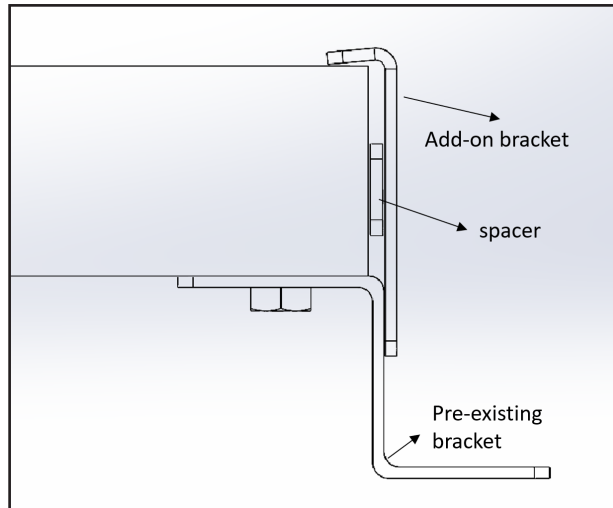
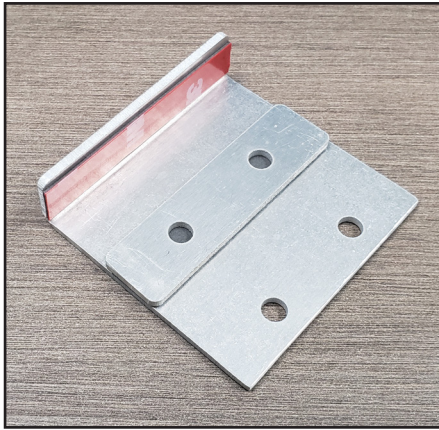

3. After installing the spacer piece in the corresponding location, peel the adhesive backing on the add-on bracket and stick it flush to the panel.
4. Drill the top hole first and thread a screw into the panel.

NOTE: Be careful and drive the screw slowly into the thin panel wall to avoid stripping it out.

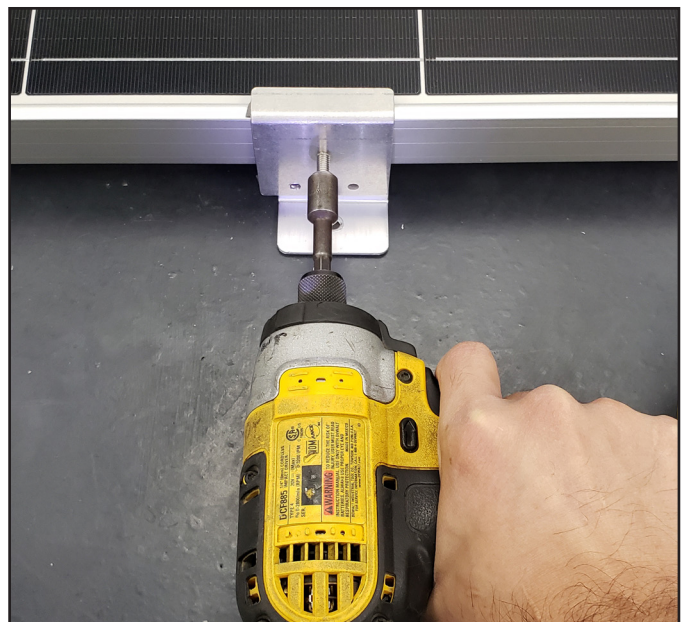
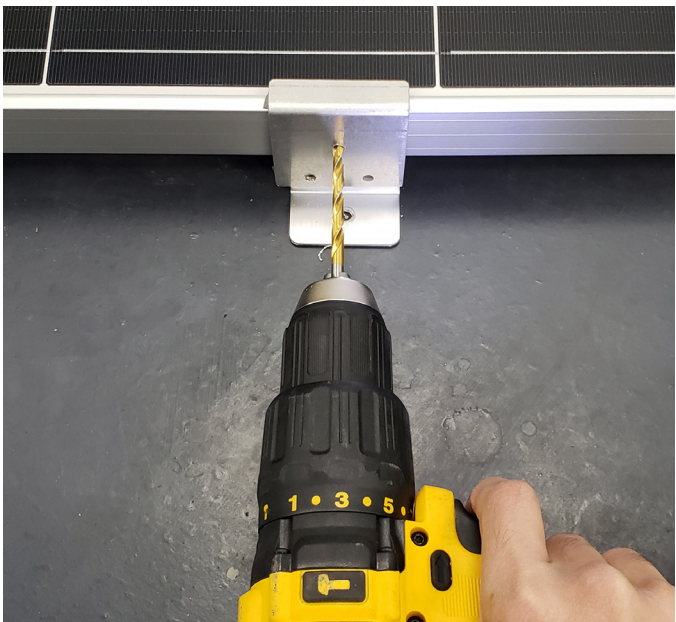

WAY SOLAR PANEL FIELD REWORK INSTRUCTIONS

Recall Number:	23E-027		
Product:	WAY Solar Panel		
Date:	April 13, 2023	Labor Rate:	0.7 Hours

5. Drill the other two holes and secure the bracket with the two more #12 screws.

NOTE: Be careful and drive the screws slowly to avoid stripping them out.

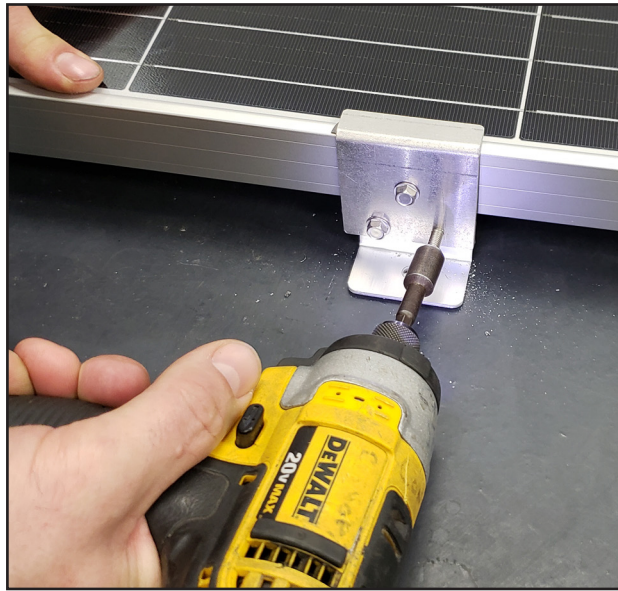

6. Repeat the process for the other brackets which completes the reworking process of the Type B mounting bracket.

