



GROUP	MODEL
Safety Recall Campaign	2015-2019MY Soul EV (PS EV)
NUMBER	DATE
SC267 (Rev 1, 08/31/2023)	August 2023

SAFETY RECALL CAMPAIGN

HIGH-VOLTAGE BATTERY PACK AND BATTERY MANAGEMENT SYSTEM (SC267)

NOTICE

This bulletin has been revised to include additional information. New/revised sections of this bulletin are indicated by a black bar in the margin area.

This bulletin provides information regarding High-Voltage Battery Pack and Battery Management System (BMS) for the subject vehicles below. An electrical short circuit between the anode and cathode of the battery cells can occur within the high-voltage battery pack assembly (BPA) case located underneath the vehicle. If an electrical short circuit occurs, a fire may result while driving, thereby increasing the risk of injury.

For the affected 2015-2017 MY SOUL EV vehicles manufactured from July 15, 2014 through June 30, 2017 that had their high-voltage battery replaced under warranty with an E400 battery, dealers are to:

- 1) First, replace the BMS and the Voltage & Temperature Sensor Wiring Harness (VTSWH),
- 2) Update the BMS with new software, and
- 3) Inspect the High-Voltage Battery and, in necessary, replace it with a new one.

For all 2018-2019 MY SOUL EV vehicles manufactured from July 3, 2017 through September 28, 2018 equipped with an E400 high-voltage battery, dealers are to:

- 1) Update the BMS with new software in Manual Mode only, and
- 2) Inspect the High-Voltage Battery and, if necessary, replace it with a new one

Before conducting the procedure, verify that the vehicle is included in the list of affected VINs.

NOTICE

There is no charge to the vehicle owner for this repair. Under applicable law, you may not sell or otherwise deliver any affected vehicle until it has been repaired pursuant to the procedures set forth in this bulletin.

Repair status for a VIN is provided on KDealer+ (Service → Warranty Coverage → Warranty Coverage Inquiry → Campaign Information). Not completed Recall / Service Action reports are available on KDealer+ (Consumer Affairs → Not Completed Recall → Recall VIN → Select Report), which includes a list of affected vehicles.

Flowcharts:

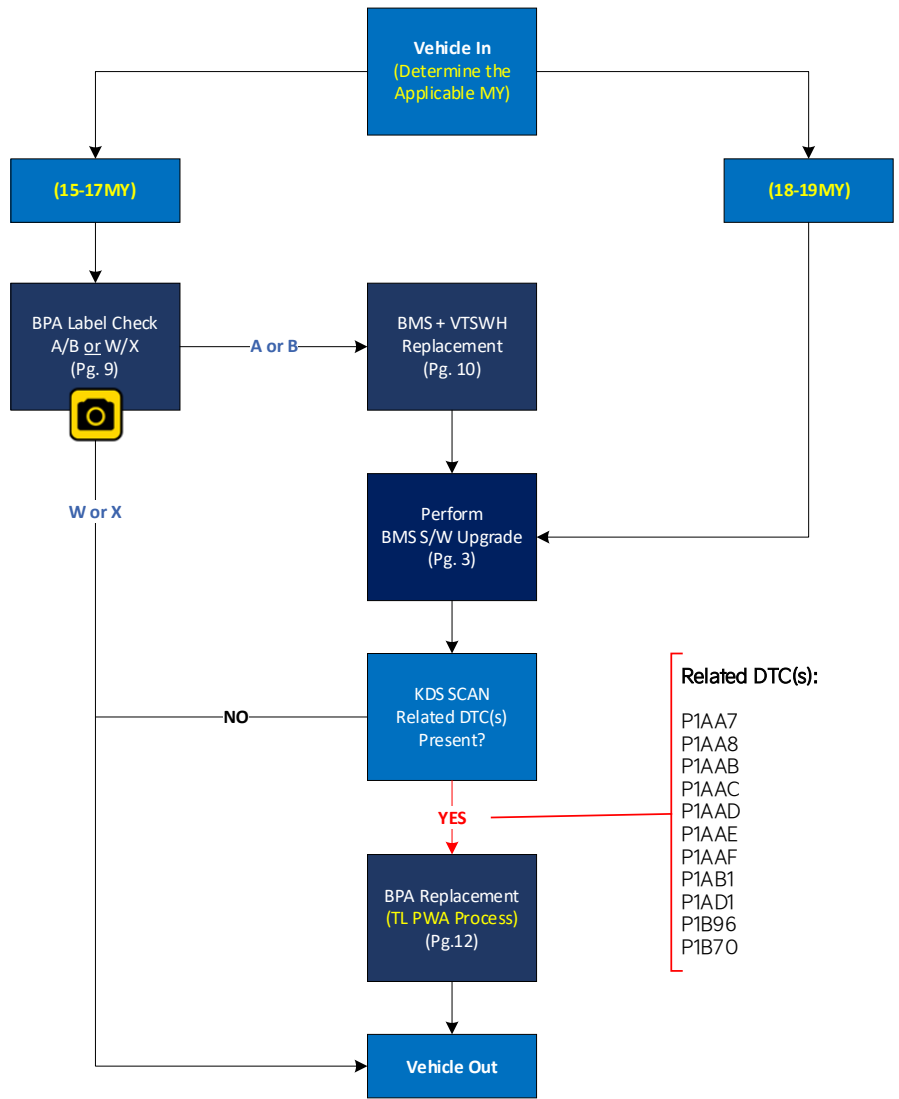

NOTICE

TL PWA is required for HV BPA replacement. Dealer should follow the process included in TSB ELE044 and obtain TL PWA . Claim submission concerns WILL occur if the dealer does not obtain TL PWA for HV BPA replacement. Claim submission concerns WILL occur if the dealer does not obtain and attach a KVID Picture  of the BPA label to the claim.

Operation Descriptions:

- BMS Software (BMS S/W)
- High Voltage Battery Pack Assembly (HV BPA)
- Voltage & Temperature Sensor Wiring Harness (VTSWH)
- Battery Management System (BMS)

Note: For 15-17MY only, the two (2) VTSWH previously installed on the existing HV BPA will need to be swapped if a 'new' HV BPA if replacement is performed.



SUBJECT:

HV BATTERY PACK AND BATTERY MANAGEMENT SYSTEM (SC267)**ECU Upgrade Procedure:**

To correct this condition, the ECU should be reprogrammed using the KDS download, as described in this bulletin.

Upgrade Event Name
*696. 15-17MY PS EV BMS Diagnostic Logic Enhancement Touch
697. 18-19MY PS EV BMS Diagnostic Logic Enhancement Touch

*Note: Event #696 for 15-17MY PS EV will not appear in the upgrade events list as it needs to be performed in 'Manual Mode' only.

NOTICE

- Confirm a fully charged battery (12.3 volts or higher is necessary) is used or utilize a fully charged jump starter box connected to the battery.
- **Ensure the KDS GDS is sufficiently charged at 60% or higher prior to reflash.**
- All ECU upgrades must be performed with the ignition set to the 'ON' position unless otherwise stated.
- **Damaged VCI II units should not be used and promptly replaced.**
- Be careful not to disconnect the VCI-II connected to the vehicle during the ECU upgrade procedure.
- **DO NOT start the engine during ECU upgrade.**
- DO NOT turn the ignition key 'OFF' or interrupt the power supply during ECU upgrade.
- **When the ECU upgrade is completed, turn the ignition 'OFF' and wait 10 seconds before starting the engine.**
- ONLY use approved ECU upgrade software designated for the correct application.

IMPORTANT

It is recommended to ALWAYS check the Electronic Parts Catalog (EPC) to locate the ECU Part Number respective to Auto/Manual Mode ROM IDs. DO NOT reference the parts label affixed to the ECU.

NOTICE

Before attempting an ECU upgrade on any Kia model, make sure to first determine whether the applicable model is equipped with an immobilizer  security system. Failure to follow proper procedures may cause the PCM to become inoperative after the upgrade and any claims associated with this repair may be subject to chargeback.

ROM ID INFORMATION TABLE:

Upgrade Event #696 (15-17MY) or #697 (18-19MY)

Model	SYSTEM	IMMO 	ECU P/No.	ROM ID	
				Previous	New
PS EV 18-19MY	BMS	Yes	37513 E4350	4400 4500 4600	4700
			37513 E4300	4402 4502 4602	4702
37513 E4251			4604	4704*	
37513 E4201			4606	4706*	
PS EV 15-17MY*					

Note: *Perform Event #696 in 'Manual Mode' only for 15-17MY model.

To verify the vehicle is affected, be sure to check the Calibration Identification of the vehicle's ECM ROM ID and reference the Information Table as necessary.

NOTICE

Prior to performing the ECU upgrade, be sure to check that the KDS is fully charged.

1. Connect the VCI-II to the OBD-II connector, located under the driver's side of the instrument panel.

NOTICE

The ECU upgrade function on KDS operates wirelessly. It is not necessary to perform the upgrade via USB cable.



SUBJECT:

HV BATTERY PACK AND BATTERY MANAGEMENT SYSTEM (SC267)

- With the ignition ON, turn ON the KDS tablet. Select 'KDS' from the home screen.



- Confirm communication with VCI (A) and then configure the vehicle (B) using the 'AUTO VIN' (C) feature.

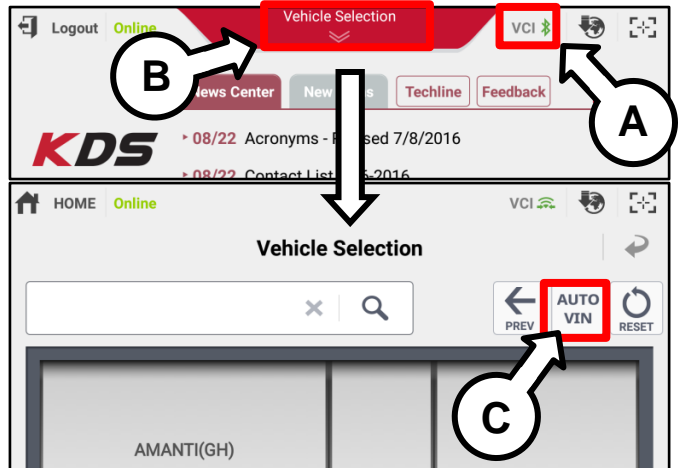

- Select 'ECU Upgrade'.

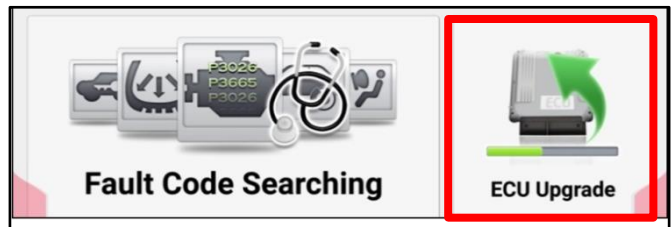

- The KDS will check the server for recently uploaded Events and then automatically download Upgrade Event #697.

NOTICE

The vehicle must be identified in Vehicle Selection to download an Event for that vehicle.

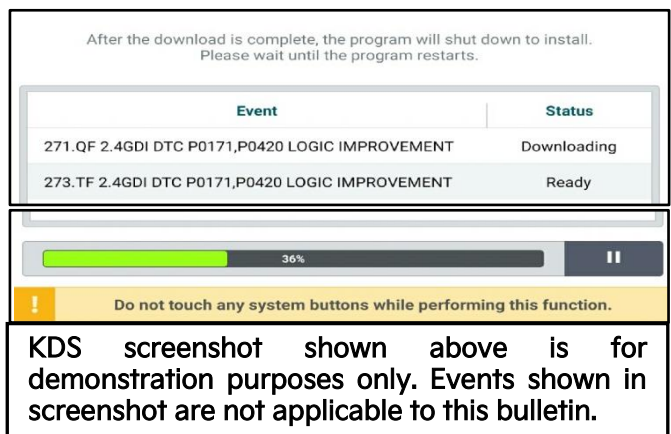

SUBJECT:

HV BATTERY PACK AND BATTERY MANAGEMENT SYSTEM (SC267)

6a. Select 'Auto Mode'. (18-19MY)

CAUTION

Do NOT attempt to perform a Manual Mode upgrade UNLESS Auto Mode fails. Always follow the instructions given on the KDS in either Auto or Manual mode.

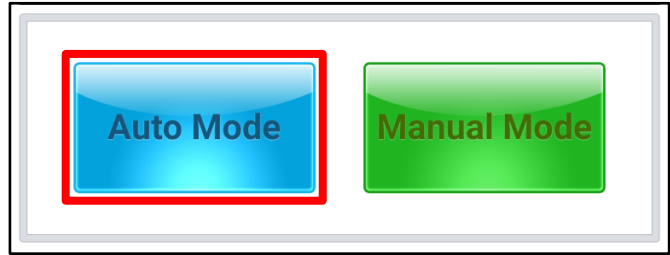

6b. Select 'Manual Mode' (15-17MY) ONLY

Refer to page 8 for instructions.

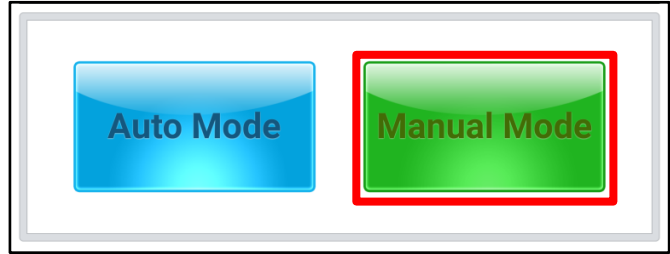

7. Select 'BMS' system and confirm the applicable Event #696 or #697.

Note: Event #696 for 15-17MY PS EV will not appear in the upgrade events list as it needs to be performed in 'Manual Mode' only.

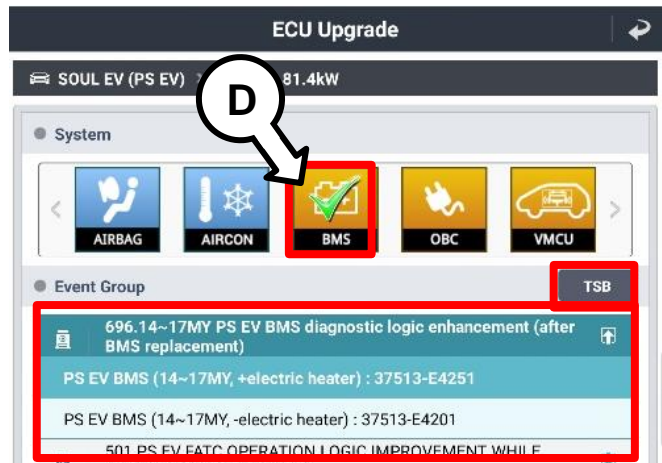

8. The ECU upgrade will begin and the progress of the upgrade will appear on the bar graph. Upgrade part (1/2) (E) will download the upgrade event to the VCI-II. Upgrade part (2/2) (F) will upgrade the ECU.

CAUTION

Do not touch the system buttons (like 'Back', 'Home', 'etc.') while performing ECU Upgrade.

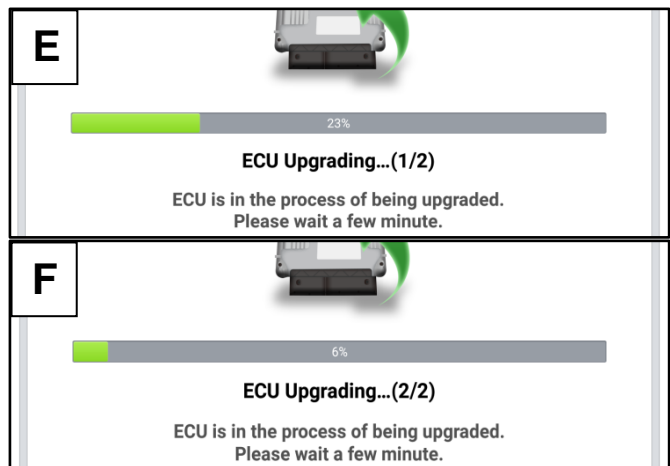

SUBJECT:

HV BATTERY PACK AND BATTERY MANAGEMENT SYSTEM (SC267)

9. If a "Communication Fail" screen appears, verify that the VCI-II and KDS are communicating properly. Select 'OK' and restart the from step 4.

NOTICE

If an error notice continues to appear or if the upgrade cannot be performed, DO NOT disconnect the KDS/VCI-II. Contact GIT America Help Desk at (888) 542-4371 or Techline.

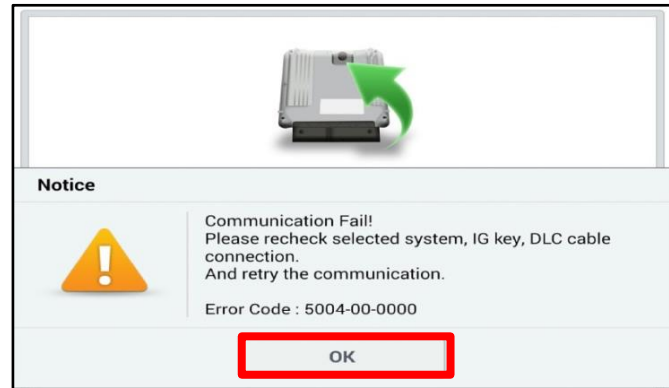

10. When instructed on the KDS, turn the ignition OFF for ten (10) seconds then back on. Select 'OK' to continue.

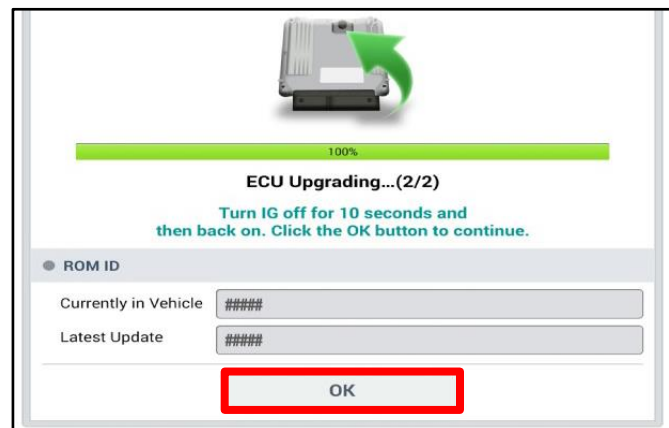

11. Once the upgrade is complete, select 'OK' to finalize the procedure.

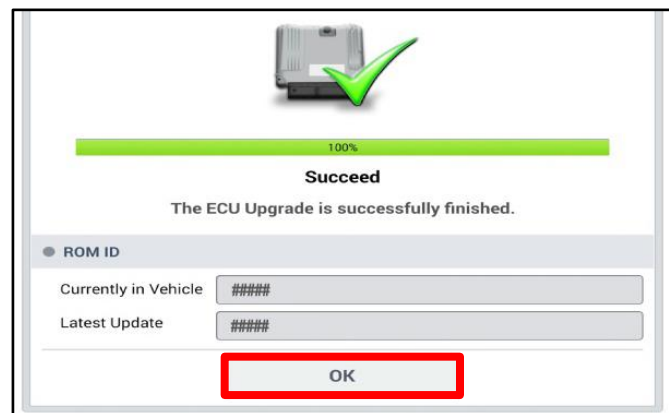

12. When prompted, select 'YES' to check for Diagnostic Trouble Codes (DTC) and erase any DTCs stored such as EPS, ESC, and TPMS that may have been set during the upgrade.

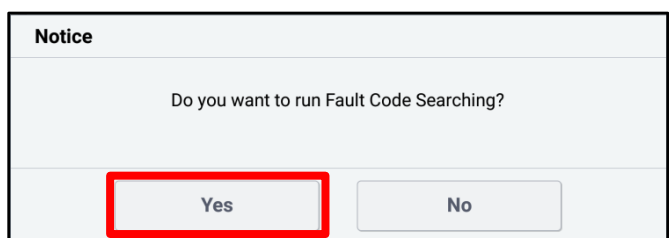

13. Start the engine to confirm normal operation of the vehicle.

Manual Upgrade Procedure:**NOTICE**

The manual upgrade should ONLY be performed if the automatic upgrade fails.

If the automatic upgrade fails, turn the ignition 'OFF' for about 10 seconds then place it back in the 'ON' position to reset the control unit BEFORE performing manual upgrade.

See table below for 'Manual Mode' passwords.

Manual Mode ECU Upgrade Passwords

Menu	Password
PS EV BMS (15~17MY, +electric heater): 37513-E4251	1524
PS EV BMS (15~17MY, -electric heater): 37513-E4201	3751
PS EV BMS (18~19MY, +electric heater): 37513-E4350	0534
PS EV BMS (18~19MY, -electric heater): 37513-E4300	3157

Note: *Perform Event #696 in 'Manual Mode' only for 15-17MY model.

1. Within the ECU Upgrade screen displayed, select **Manual Mode**.
2. Select the '**BMS**' system under the System selection menu. Select **Upgrade Event #696 or #697** (if Auto Mode failed) and select **Upgrade** to continue.
3. Select the appropriate control unit part number with reference to the ROM ID Information Table on page 3, and select **OK**.
4. Enter the appropriate password from the Manual Mode password table above and select **OK**.
5. The upgrade will begin and the progress of the upgrade will appear on the bar graph.
6. When instructed on the KDS, turn the ignition **OFF** for ten (10) seconds then back on. Select **OK**.
7. Once the upgrade is complete, select **OK** to finalize the procedure.
8. When prompted, select **YES** to check for Diagnostic Trouble Codes (DTC) and erase any DTCs stored such as EPS, ESC, and TPMS that may have been set during the upgrade.
9. Start the engine to confirm proper operation of the vehicle.

SUBJECT:

HV BATTERY PACK AND BATTERY MANAGEMENT SYSTEM (SC267)

WARNING

Be sure to read and follow the 'General Safety Information and Caution', the 'High Voltage Shut-Off Procedures' and 'High Voltage Battery Handling Guide' instructions outlined on KGIS before doing any work related with the high voltage system. Failure to follow the safety instructions may result in serious electrical injuries.

BPA Inspection Procedure: (15-17MY Only)

1. Remove the BPA upper case (A) by referring to "EV Battery System → High Voltage Battery System → Case → Repair procedures (Removal)" in the applicable Shop Manual on KGIS. Refer to KGIS for bolt/nut torque specs.

**TECH TIP**

Mark the six (6) 'ground' bolts and their location to prevent mixing with regular bolt prior to reassembly.

Regular Bolt (8)



Ground Bolt (E)



Ground Bolt (E): 6 ea.

Regular Bolt (8): 35 ea.

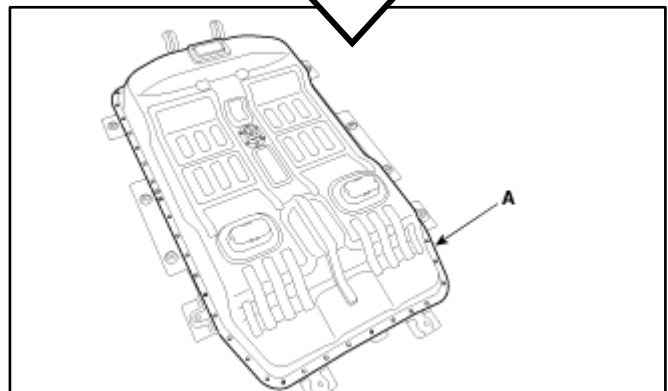

2. Verify the 2nd to last letter of the Battery Pack Assembly (BPA) shown and take a photo of the label using KVID and attach it to the claim:

- **A or B:** Replace BMS ECU and VTSWH (Page 10) and upgrade the BMS ECU Software (Page 3).
- **W or X:** No further action required. Reinstall all removed parts in the reverse order of removal and confirm normal vehicle operation.

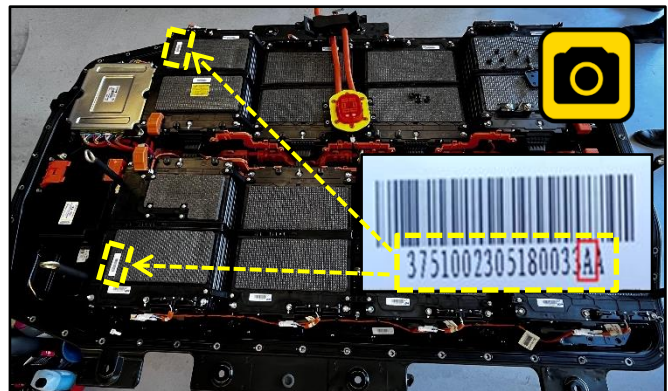

Note: BPA Part Number starts with 37510...

BMS ECU Replacement Procedure: (15-17MY Only)

1. Replace the BMS ECU by referring to “EV Battery System → High Voltage Battery Control System → Battery Management System (BMS) ECU → Repair procedures (Removal)” in the applicable Shop Manual on KGIS.

**VTSWH Replacement Procedure: (15-17MY Only)**

1. Carefully remove ONLY ONE (1) (left or right) side battery pack assemblies.

Refer to the “EV Battery System → High Voltage Battery System → Battery Pack Assembly → Repair procedures (Removal)” in the applicable Shop Manual on KGIS for detailed instructions.

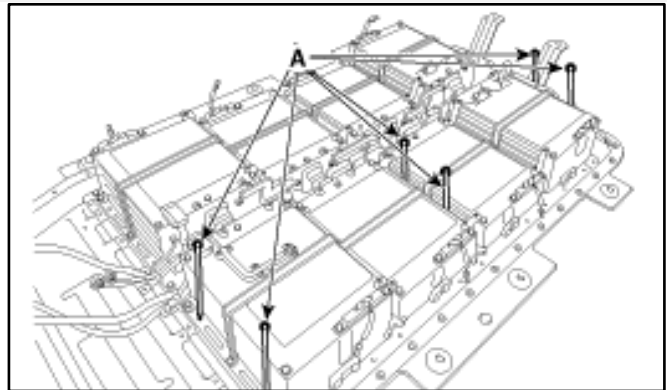

Note: SST OK375 E4300 and crane jack are required.

2. Place the battery on a clean and flat bench surface area.

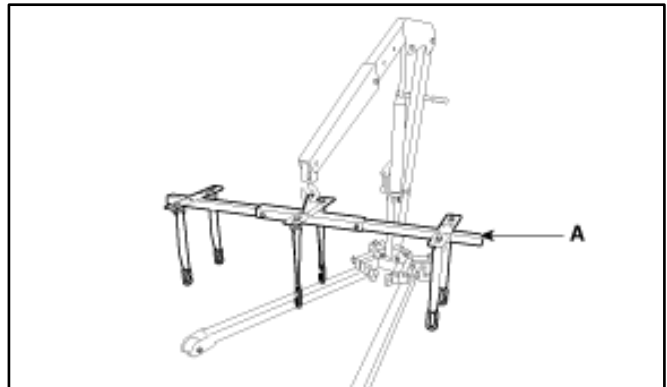

3. Remove the existing voltage and temperature sensor wiring harness (VTSWH) retaining screws for both (left and right) battery packs.

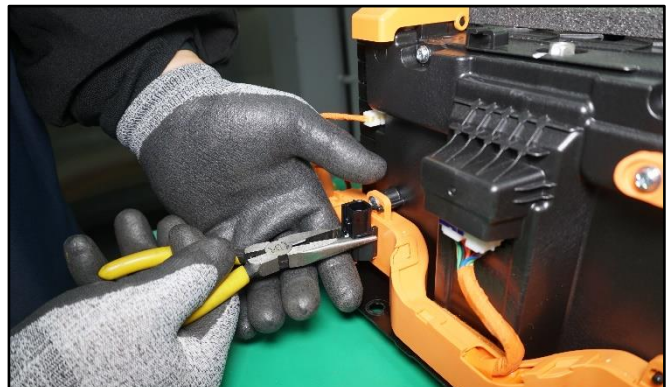

SUBJECT:

HV BATTERY PACK AND BATTERY MANAGEMENT SYSTEM (SC267)

- Replace the two voltage temperature sensor wire harnesses (VTSWH) with the new parts.

Note: The new harness is different for the removed harness when compared side by side.

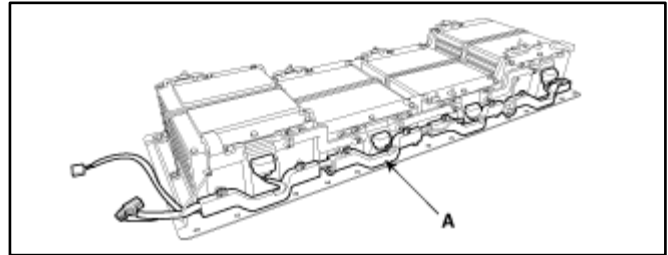
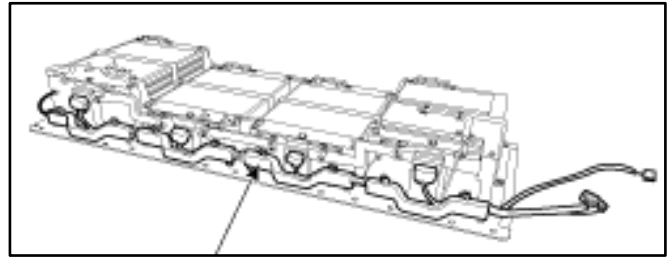
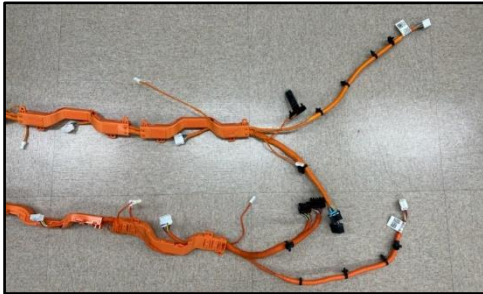

- During re-assembly, insert the battery temperature sensor into the battery pack lower side area shown.

Connect the outside temperature sensor connector where shown.

Note: Some vehicles may have a connector hole. If so, disregard, no need to connect to it.

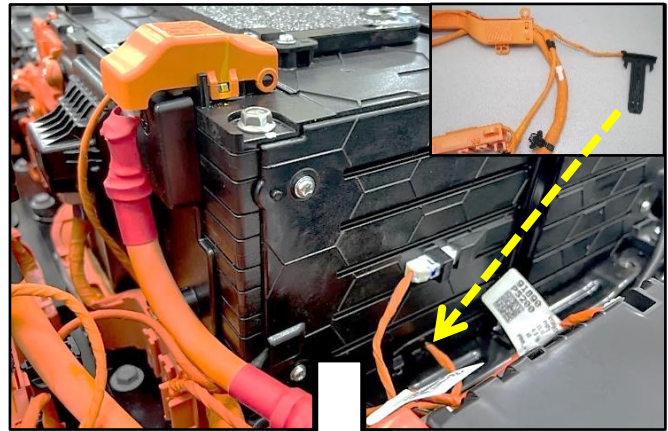

- Reinstall all removed parts in the reverse order of removal.
- Perform the BCM Software Upgrade as outlined on page 3.
- Confirm normal vehicle operation.
- Using KDS, scan for related DTC described on page 2. Are related DTC(s) present?

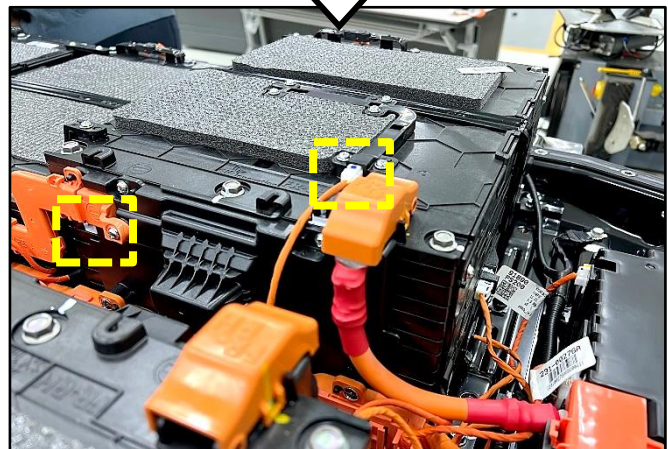

- YES (NG)** - Related DTC(s) are stored. Replace the BPA Assembly (Page 12)
- NO (OK)** - No DTC(s) or Non-Related DTC(s) stored. Campaign is complete.

⚠ WARNING

Be sure to read and follow the 'General Safety Information and Caution', the 'High Voltage Shut-Off Procedures' and 'High Voltage Battery Handling Guide' instructions outlined on KGIS before doing any work related with the high voltage system. Failure to follow the safety instructions may result in serious electrical injuries.

BPA Replacement Procedure: (15-19MY if applicable)

1. Replace the HV BPA by referring to "EV Battery System → High Voltage Battery System → Battery Pack Assembly → Repair procedures (Removal)" in the applicable Shop Manual on KGIS.

Note: Dealer must obtain TL PWA.

ⓘ IMPORTANT

15-17MY ONLY new **BPA** is equipped with an "old" type harness. Be sure to swap/install the "new" type harness.



Note: SST OK375 E4300 and crane jack are required.

📄 NOTICE

Place the removed BPA on a clean flat surface. Dealer should follow the process included in TSB ELE044 and obtain TL PWA.

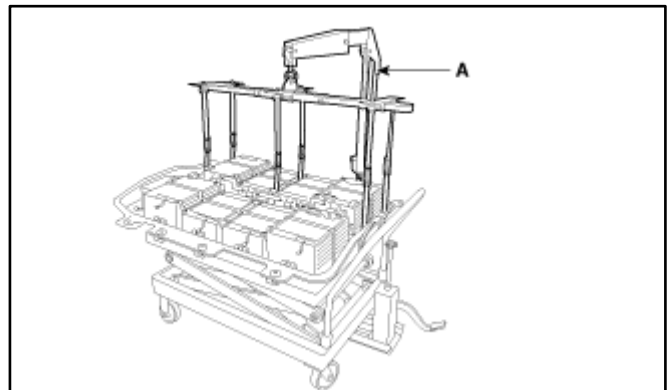

Note: The battery pack assembly (BPA) consists of two (2) (left and right) battery packs.

ⓘ IMPORTANT

18-19MY ONLY new **BPA** is equipped with the "new" type harness. There is no need to swap.

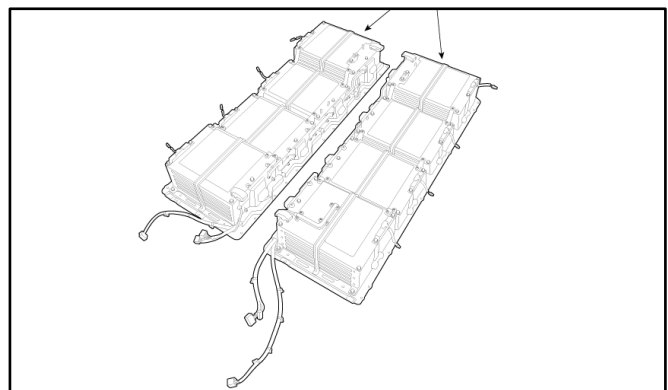

SUBJECT:



HV BATTERY PACK AND BATTERY MANAGEMENT SYSTEM (SC267)**AFFECTED VEHICLE RANGE:**

Model	Production Date Range
15-17MY Soul EV (PS EV)	July 15, 2014 to June 30, 2017
18-19MY Soul EV (PS EV)	July 3, 2017 to September 28, 2018

REQUIRED TOOL:

Tool Name	Part Number	Figure	Comments
BPA Lifting Jig	OK375 E4300		To be used along with an engine crane/hoist.

REQUIRED PART:

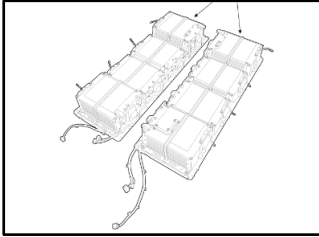
Part Name	Part Number	Figure	Qty.	Comment
Volt. & Temp. Sensor Wire Harness (VTSWH) <i>(New for 15-17MY only)</i>	37561 E4210QQK		1	Left Side
	37561 E4220QQK		1	Right Side
Battery Management System (BMS) <i>(15-17MY only)</i>	37513 E4201QQK		1	Non-Heated
	37513 E4251QQK			Heated
Battery Pack Assembly (BPA)* <i>(15-17MY only are equipped with an original/old VTSWH)</i>	37510 E4202R		1	Non-heated
	37510 E4252R			Heated
HV Battery Pack Assembly (BPA) (18-19MY)	37510 E4302R		1	Non-heated
	37510 E4352R			Heated

***Note:** If replacement of the BPA for 15-17MY is required after already having installed the two (2) new VTSWH and BMS, then the 'new' BPA (left and right side battery packs) will require the 'new' previously installed VTSWH on the existing BPA to be installed/swapped onto the 'new' BPA.

IMPORTANT: The parts listed below **DO NOT** required replacement unless damaged or lost during removal.

Case Gasket (15-19MY)	37528 E4000QQK	N/A	1	Replace <u>only</u> if damaged
Bolt & Washer for BPA	11408 06166PQQK	N/A	1	3pc. Included per pack are needed.
Nut for VTSWH	37535 E4500QQK	N/A	1	

SUBJECT:

HV BATTERY PACK AND BATTERY MANAGEMENT SYSTEM (SC267)

WARRANTY INFORMATION:

N Code: N99 C Code: C99

MY	Claim Type	Causal P/N	Qty.	Repair Description	Labor Op Code	Op Time	Replacement P/N	Qty.	
15-17MY	R	37510 E4000	0	(SC267) BPA Label Check (Non-Campaign)	231055R0	1.3 M/H	37528 E4000QQK	1	
				(SC267) BPA Label Check + BMS & VTSWH Replacement + BMS SW Upgrade + KDS DTC Scan (OK)	231055R1	2.5 M/H	37561 E4210QQK	1	
							37561 E4220QQK		
15-17MY	R	37510 E4000	0	(SC267) BPA Label Check + BMS & VTSWH Replacement + BMS SW Upgrade + KDS DTC Scan (NG) + HV BPA Replacement + VTSWH Swap	231055R2	5.6 M/H	37528 E4000QQK	1	
							37513 E4201QQK or 37513 E4251QQK		
							11408 06166PQQK		
15-17MY	R	37510 E4000	0	(SC267) BPA Label Check + BMS & VTSWH Replacement + BMS SW Upgrade + KDS DTC Scan (NG) + HV BPA Replacement + VTSWH Swap	231055R2	5.6 M/H	37535 E4500 QQK	1	
							37561 E4210QQK		
							37561 E4220QQK		
18-19MY	R	37510 E4000	0	(SC267) BMS SW Upgrade + KDS DTC Scan (OK)	231055R3	0.3 M/H	N/A	0	
				(SC267) BMS SW Upgrade + KDS DTC Scan (NG) + HV BPA Replacement	231055R4	3.0 M/H	37510 E4302R or 37510 E4352R	1	
18-19MY	R	37510 E4000	0	(SC267) BMS SW Upgrade + KDS DTC Scan (NG) + HV BPA Replacement	231055R4	3.0 M/H	37528 E4000QQK		1
							11408 06166PQQK		
							37535 E4500 QQK		

Note: Refer to Warranty Bulletin 2023-24 for claim submission procedures. When necessary, manually enter sublet code 'X2' for reimbursement of one roundtrip rideshare expense or up to three (3) days for rental for BMS or HV BPA Replacement. Claim submission concerns WILL occur if the dealer does not obtain and attach a KVID Picture of the BPA label to the claim, as described in page 9.

NOTICE

VIN inquiry data for this repair is provided for tracking purposes only. Kia retailers should reference SC267 when accessing the KDealer+ system.

