

March 24, 2023

Version 3

Safety Recall: 2019 Insight Front Seat Belt Buckle Repair

Supersedes 23-003, dated March 16, 2023, to revise the information highlighted in yellow.

AFFECTED VEHICLES

Year	Model	Trim	VIN Range
2019	Insight	ALL	Check the iN VIN status for eligibility.

REVISION SUMMARY

- Under WARRANTY CLAIM INFORMATION, a note was added.
- Under SEAT BELT BUTTON REPLACEMENT REPAIR VERIFICATION, step 7 had a note added.
- Under SEAT BELT BUCKLE REPLACEMENT, step 17 had a note added.

BACKGROUND

Due to improper manufacturing of the seat belt buckle channel, the front seat belt buckles may not latch properly. An improperly latched seat belt buckle may not securely restrain occupant(s), increasing the risk of injury to the occupant.

CUSTOMER NOTIFICATION

Owners of affected vehicles will be sent a notification of this campaign.

Do an iN VIN status inquiry to make sure the vehicle is shown as eligible.

Some vehicles affected by this campaign may be in your new or used vehicle inventory.

Failure to repair a vehicle subject to a recall or campaign may subject your dealership to claims or lawsuits from the customer or anyone else harmed as a result of such failure. Before selling a vehicle in inventory, always check if it is affected by a safety recall by conducting a VIN status inquiry.

CORRECTIVE ACTION

Inspect the seat belt buckle. Replace the button or replace the complete buckle assembly based on the inspection results.

NOTE:

- Videos were prepared by Honda showing the main steps outlined in this bulletin. Review all of the videos before contacting the Tech Line with questions about this bulletin.



- Click here to watch the complete video.

CUSTOMER INFORMATION: The information in this bulletin is intended for use only by skilled technicians who have the proper tools, equipment, and training to correctly and safely maintain your vehicle. These procedures should not be attempted by "do-it-yourselfers," and you should not assume this bulletin applies to your vehicle, or that your vehicle has the condition described. To determine whether this information applies, contact an authorized Honda automobile dealer.

PARTS INFORMATION

NOTE: Place an order after inspection; most units will need repair not buckle replacement.

Part Name	Part Number	Quantity
Buckle Button	81479-TLA-305	1

TOOLS INFORMATION

Tool Number	Description	Quantity
American Honda Authorized Mobile Device (used for the airbag inflator recall).	Make sure all devices are plugged in and connected to Wi-Fi for the device to receive the Buckle Service App update.	1
07AAB-TVAA100	G-Mass Tool (#2 Tool)	5
07AAC-TVAA100	Removal Tool (#1/3 Tool)	5
Commercially Available	T10 Safety Torx Bit	2

NOTE: These special tools were auto-shipped to all dealers by March 10th, 2023.

WARRANTY CLAIM INFORMATION

NOTE: To submit a warranty claim, the warranty codes needs to be entered into the "Test Code" field on the warranty claim form. Please have your technician provide the warranty code.

TEST CODE FIELD

Repair Information				View Flat Rate Labor Time
Defect Code (Exclude Dash)	6XL00	Test Code	<input type="text"/>	
Item	Labor Operation No.	Labor Description	Time	
1	8555A6	SAFETY RECALL CAMPAIGN: DRIVER SEATBELT BUTTON, REPLACE (INCLUDES INSPECTION)	0.4	
2				
3				
Total Time			0.4	
On	NO	Diagnostic Trouble Codes	<input type="text"/>	<input type="text"/>

Seatbelt Button Repair

Operation Number	Description	Flat Rate Time	Defect Code	Symptom Code	Template ID	Failed Part Number
8555A6	Driver Seatbelt Button Replace (Includes: Function, DTC Indicator, and Residue check).	0.4hr	6XL00	BCD00	A23003A	04816-TVA-A20ZA
8655A2	Passenger Seatbelt Button Replace (Includes: Function, DTC Indicator, and Residue check).	0.4hr	6XR00	ODH00	A23003B	04813-TVA-A10ZA

Seatbelt Buckle Replacement + Inspection

Operation Number	Description	Flat Rate Time	Defect Code	Symptom Code	Template ID	Failed Part Number
8551F6	Driver Seatbelt Buckle Replace (Includes: Inspection)	0.6hr	6XL00	BDC00	A23003C	04816-TVA-A20ZA
A	For Buckle causing DTC check and troubleshooting only (any other DTC normal troubleshooting applies).	0.3hr		BDC00	A23003D	

Operation Number	Description	Flat Rate Time	Defect Code	Symptom Code	Template ID	Failed Part Number
8651A5	Passenger Seatbelt Buckle Replace (includes: Inspection, Seat weight calibration, and Steering angle learn).	0.7hr	6XR00	ODH00	A23003E	04813-TVA-A10ZA
A	For Buckle causing DTC check and troubleshooting only (any other DTC normal troubleshooting applies).	0.3hr		ODH00	A23003F	

NOTE:

- Due to the seatbelt part number variation for each model trim, you may add the seatbelt part number to the template.
- A new online training module, GIC93, Front Seat Belt Buckle Inspection and Repairs supports this safety recall and is available in the online university. This module is required for technician job code 0030 and must be completed by April 11th or warranty claims cannot be submitted.

INSPECTION PROCEDURE

▶ PLAY VIDEO

Prior to the Inspection Procedure, watch this video:

The Buckle Service Application is a tool developed to:

- Determine if a vehicle's driver's and front passenger's seatbelt buckles meets the requirements for a button replacement or if a complete buckle assembly replacement is required to complete the repair.
- Confirm the repair was done correctly when a button has been replaced.
- Document the new buckle being installed when a buckle replacement is required.

NOTE: The repair must be performed in an area with a strong Wi-Fi connection. Refer to the Tips and Tricks section at the end of this service bulletin for additional information regarding this application and repair.

1. The Buckle Service Application is available on your existing American Honda approved mobile device that is already being utilized for the airbag inflator safety recalls. Locate and tap on the icon to open the Buckle Service Application.

NOTE: If the application icon is not displayed on the home screen, power off the device. The application will automatically update on the device when it is powered up.

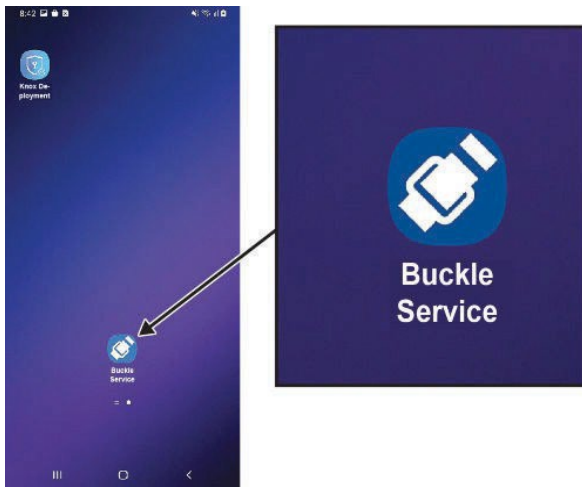

2. Sign-in to the Buckle Service Application using your Interactive Network (iN) credentials.

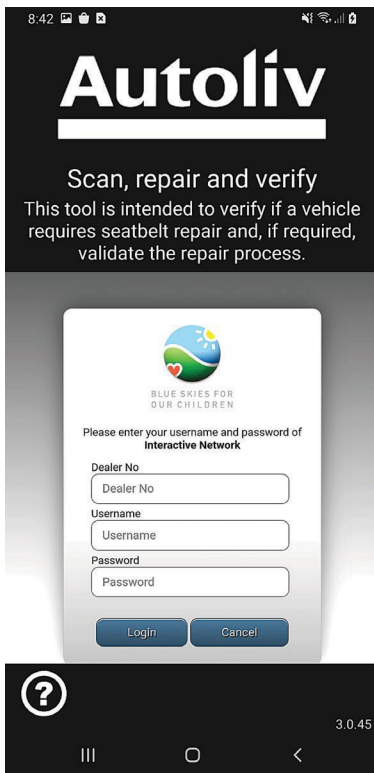

3. Scan the VIN to determine the buckle repair status.

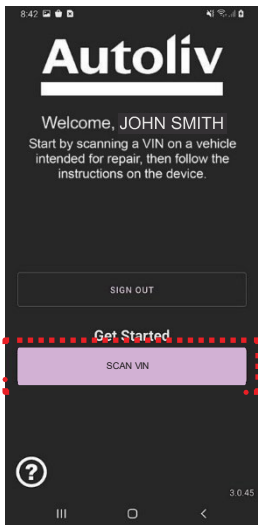

Tap **SCAN VIN** to activate the barcode reader.

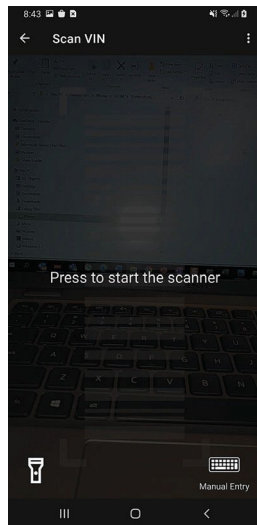

Tap anywhere on the screen to activate the scanner and scan the VIN.



Align the VIN barcode in the door jamb to the outline displayed on the screen.

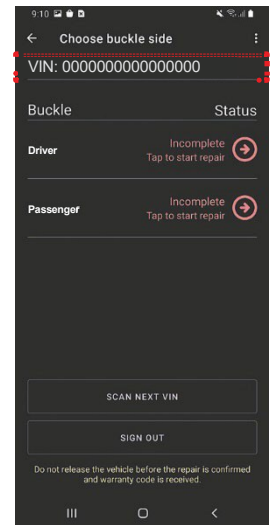

Confirm the VIN displayed on the Status Screen matches the VIN that was scanned.

4. View and select vehicle's Buckle Status to continue (choosing Driver's or Passenger's side).

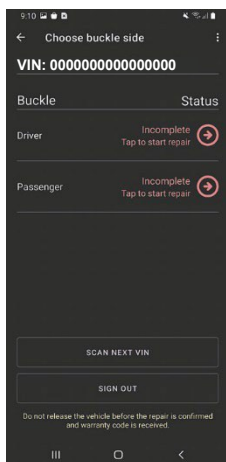

STATUS	MEANING
Incomplete	Repair process not complete.
Completed	Repair process complete.
Verification Failed	The application was unable to validate the repair or an analyst reviewed buckle button replacement repair images and determined that the repair was not performed correctly. (Full buckle replacement is required)
Waiting for Verification	Buckle button replacement is still being reviewed by an analyst.
Function Check Failed <i>Buckle Replacement Required.</i> Indicator/DTC Check Failed <i>Buckle Replacement Required.</i> Residue Check Failed <i>Buckle Replacement Required.</i>	One of the verification processes failed and will require a full buckle replacement.

5. Insert the tongue into the buckle and tug on the seatbelt to confirm the buckle is securely latched. Unlatch the buckle and repeat the process 3 to 4 times.

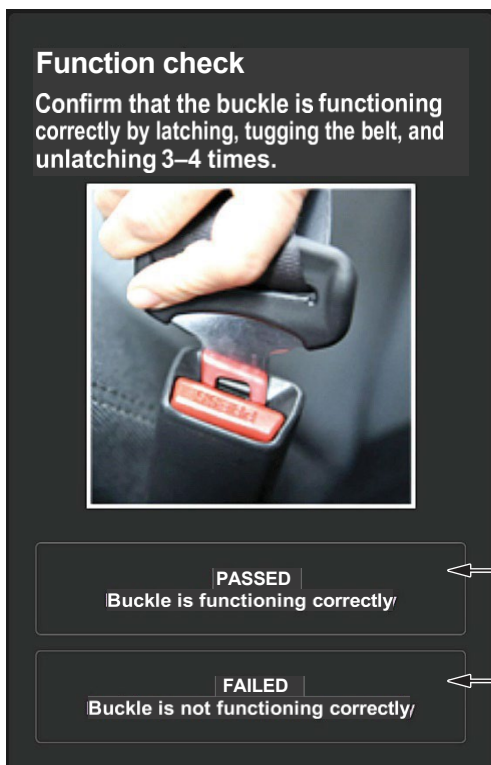

Select **PASSED**, if the buckle is functioning correctly. (go to step 6)

Select **FAILED**, if the buckle is not functioning correctly. (go to Seat Belt Buckle Replacement)

- Check for an SRS indicator light on in the instrument panel. Press the start button twice to set the power mode to ON and monitor the SRS indicator. The indicator should illuminate and then turn off within **10 seconds**.

Check for SRS indicators (MID))

- Turn vehicle IGN ON
- Wait 10 sec for MID to fully boot up

Does the SRS indicator stay ON after 10 sec?



NO
The SRS indicator is not on

YES
The SRS indicator is on

Select **NO**, if the SRS light is not illuminated after 10 seconds. (go to step 10)

Select **YES**, if the SRS light remains illuminated after 10 seconds. (go to step 7)

- When **YES** is selected in the previous step, the application will request a picture of an ALL DTC CHECK from the HDS screen.

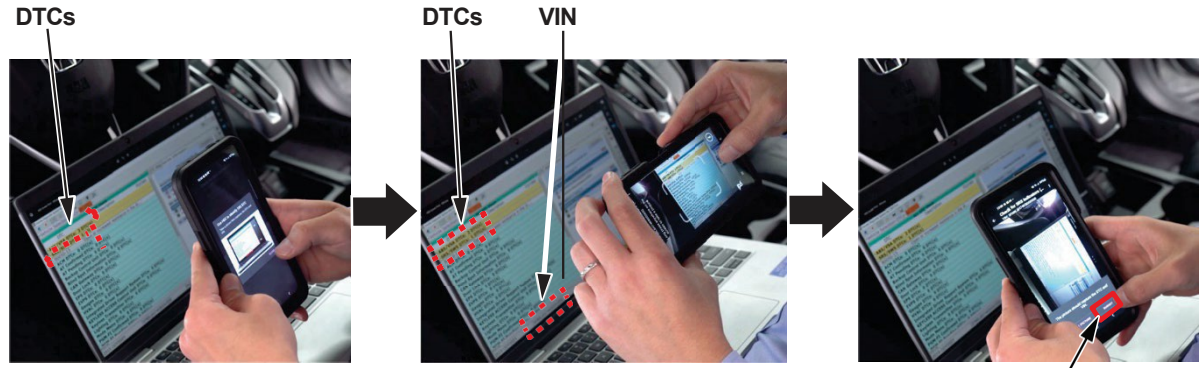

Connect HDS to the vehicle, perform an ALL DTC Check and expand the SRS/SWS DTC Menu to display the SRS DTC(s).

Frame the HDS screen in landscape orientation, making sure to capture the VIN and DTC(s) and long press anywhere on the screen to capture the picture.

Tap SUBMIT when satisfied with the picture.

8. After the picture of the HDS screen is submitted, the application displays front seat belt buckle DTCs specific to the buckle being worked on. Review the DTCs retrieved from the vehicle to determine if the DTCs match any of the DTCs displayed in the list on the application screen.

NOTE: When DTC retrieved from the vehicle does NOT match the buckle-related DTC listed in the application, open a separate repair order for that repair.

The screenshot shows a dark grey application interface. At the top, it says "Connect HDS to the DLC and perform an ALL-DTC CHECK". Below that is a question: "Does the SRS DTC retrieved from the vehicle appear in the Driver's Side Buckle DTC list below?". A list of DTCs follows: B0050 -11, B0050 -12, B0050 -13, and B0050 -2B. There are two large rectangular buttons. The top button is labeled "NO" and "The DTC is not on the list". The bottom button is labeled "YES" and "The DTC is on the list". To the right of the buttons, there are two lines of text with arrows pointing to the buttons. The first line says "Select **NO**, if the DTC(s) retrieved from the vehicle DO NOT APPEAR on the list. (go to step 10)". The second line says "Select **YES**, if the DTC(s) retrieved from the vehicle DO APPEAR on the list. (go to step 9)".

Connect HDS to the DLC and perform an ALL-DTC CHECK

Does the SRS DTC retrieved from the vehicle appear in the Driver's Side Buckle DTC list below?

B0050 -11
B0050 -12
B0050 -13
B0050 -2B

NO
The DTC is not on the list

Select **NO**, if the DTC(s) retrieved from the vehicle DO NOT APPEAR on the list. (go to step 10)

YES
The DTC is on the list

Select **YES**, if the DTC(s) retrieved from the vehicle DO APPEAR on the list. (go to step 9)

9. When **YES** is selected in the previous step, the application will direct you to do troubleshooting to identify the cause of the DTC. **DO NOT MAKE A SELECTION UNTIL TROUBLESHOOTING IS DONE.** There are several possible causes for the front seat belt buckle DTC. Refer to the service information for the DTC(s) retrieved from the vehicle.

BUCKLE LOCATION	BUCKLE DTC	DESCRIPTION
Driver	B0050-11	Short or decreased resistance in the driver's seat belt buckle switch.
Driver	B0050-12	Short to power in the driver's seat belt buckle switch.
Driver	B0050-13	Open or increased resistance in the driver's seat belt buckle switch.
Driver	B0050-2B	Short to another wire harness in the driver's seat belt buckle switch.
Passenger	B0052-11	Short or decreased resistance in the front passenger's seat belt buckle switch.
Passenger	B0052-12	Short to power in the front passenger's seat belt buckle switch.
Passenger	B0052-13	Open or increased resistance in the front passenger's seat belt buckle switch.
Passenger	B0052-2B	Short to another wire harness in the front passenger's seat belt buckle switch.

Is the buckle the cause of the DTC?

NOTE: When DTC troubleshooting determines that the buckle is **NOT** the cause, issue a separate repair order to document repairs.

Refer to the Service Bulletin and/ or Service Manual SRS DTC Troubleshooting to determine the cause of the DTC.

Possible causes for Driver side buckle DTC:

- SRS Unit
- Open or short in wire harness
- Driver's seat belt buckle assembly

Is the Driver's seat belt buckle the cause of the DTC?

NO
Driver's side buckle is not the cause of the DTC

← Select **NO**, if the buckle is NOT the cause of the DTC(s). (go to step 10)

YES
Driver's side buckle is the cause of the DTC

← Select **YES**, if the if the buckle IS the cause of the DTC(s). (go to Seat Belt Buckle Replacement)

10. Residue check.



Carefully remove the 2 Torx screws from the cover using a T10 Safety Torx Bit.



Remove the cover by gently pulling it away and downward.



Then remove the upper cover by pulling it away and upward.



NOTE:

- If equipped, lower the seat to gain better access to the torx screws that secure the cover to the buckle.
- Put the covers and screws in a secure location for installation at a later process.
- The devices flashlight will turn on automatically. Use the flashlight to thoroughly examine the buckle and button, looking for any type of sticky residue that could cause the button to not operate correctly.



NOTE: Examples of buckles with residue that would cause the buckles to fail the residue check.

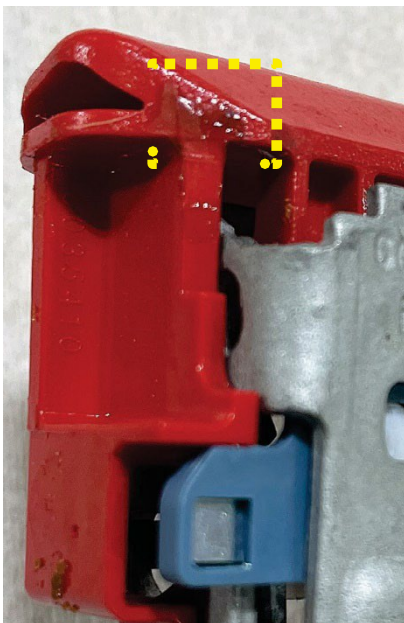



Select **PASSED**, if residue is not present.
(go to Seat Belt Button Replacement Procedure)

Select **FAILED**, if residue is present.
(go to step 11)

11. When **FAILED** is selected, the application will request a picture of the residue.



Close the picture window.



Frame the buckle within the guides, making sure to capture the residue and long press anywhere on the screen to take the picture.



Tap **SUBMIT** when satisfied with the picture.

12. After the picture is successfully uploaded, the application will proceed to the Seat Belt Buckle Replacement Procedure. Go to Seat Belt Buckle Replacement.

SEAT BELT BUTTON REPLACEMENT



Prior to Seat Belt Button Replacement, watch this video:

1. When the buckle passes all 3 verification checks (Function, SRS, & Residue), the application will direct you to replace the button. Set the application aside and **DO NOT** make a selection until directed to do so in step 6.

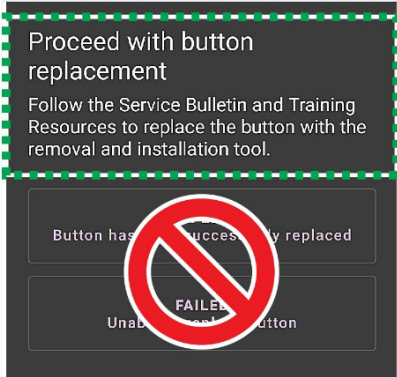

NOTE:

If a new button is not currently available:

- Do not make a selection.
- Back out of this Buckle Repair Application using the arrow located on the top left corner of the screen.

When a new button becomes available:

- Return to the Buckle Repair Application.
- Complete the repair procedure.

2. Insert the #1 tool into the buckle, listen for a click to confirm the buckle is latched, then remove the tool.



3. Install the #2 tool to secure the G-mass Sensor. The #2 tool MUST BE USED during the button replacement procedure to prevent the G-mass from falling out of place.

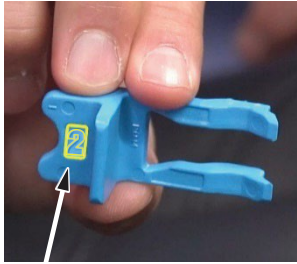

#2 TOOL

BUTTON BRIDGE

G-MASS SENSOR

#2 TOOL INSTALLED AND SECURING G-MASS

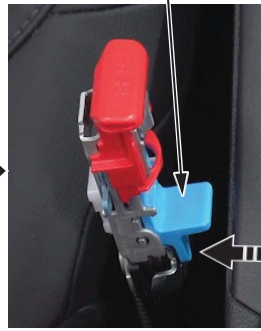
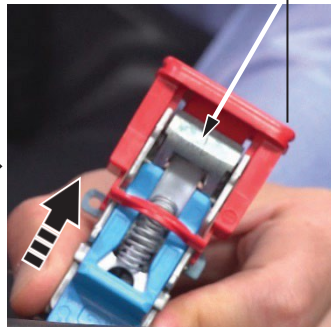
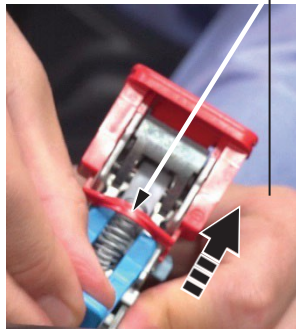

Pull the buckle away from the center console to prevent scratching/damaging the console when installing the #2 tool.

Insert the forks of the tool under the button bridge and slide it upward into place.

4. Remove the old seat belt buckle button.

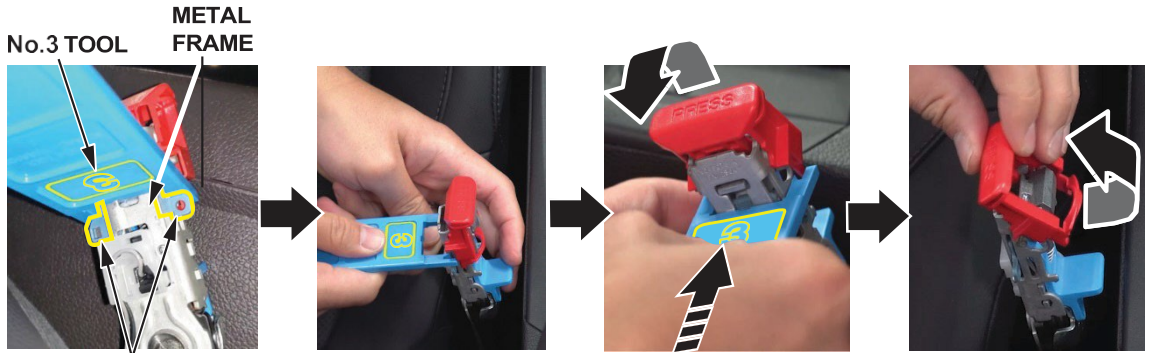

BLUE PLASTIC TABS

While holding the #2 tool, position the #3 tool outside the metal frame and just above the 2 blue plastic tabs.

Push the #3 tool to release the button.

Remove the button.

5. Install the new button.

NOTE: The new button has a QR code applied to both sides and is installed in the reverse order of removal. The QR code is used by the Buckle Service Application during the repair verification process after the button has been replaced. It also provides a method of differentiating old buttons from new buttons.

QR CODE #2 TOOL NEW BUTTON G-MASS T-BAR BUTTON RECESS T-BAR ALIGNED IN BUTTON RECESS BUTTON BRIDGE

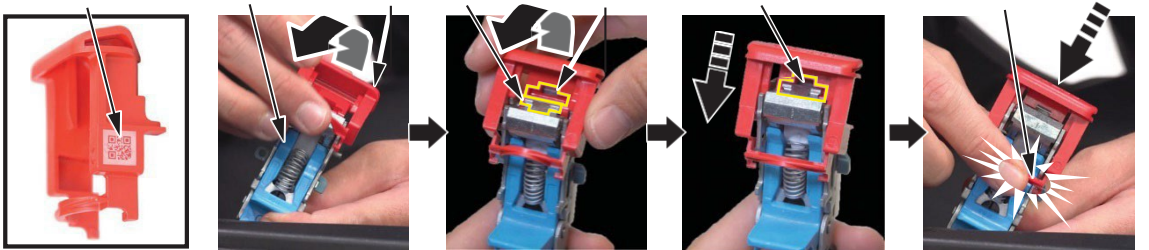

Continue holding the #2 tool, position the new button between the frame and the g-mass.

Ensure the g-mass t-bar is aligned in the recess of the button.

Gently push down on the button's bridge until an audible click is heard. Leave the #2 tool in place.

- Using side-cutters, remove the bridge from the old button then discard it.



6. Return to the Buckle Service APP to make your selection and continue.

Proceed with button replacement

Follow the Service Bulletin and Training Resources to replace the button with the removal and installation tool.

COMPLETED
Button has been successfully replaced

FAILED
Unable to replace button

Select **COMPLETED**, if the new button was successfully installed without encountering any problems. (go to verification step 7)

Select **FAILED**, if while installing the new button:

- The G-Mass shifted or fell out during the procedure.
- The new button would not snap in place. (go to Seat Belt Buckle Replacement)

SEAT BELT BUTTON REPLACEMENT REPAIR VERIFICATION

▶ PLAY VIDEO

Prior to Seat Belt Button Replacement Repair Verification, watch this video:

After selecting **COMPLETED**, the application requests a series of pictures to verify the seat belt button replacement was done correctly

1. New button verification (QR Code and #2 Tool).

- Take a picture to confirm a new button is installed and the #2 tool was used to secure the G-mass sensor during the button replacement.

NOTE: The #2 tool must be captured in the picture. If the #2 tool is not visible in the picture, the repair will not pass during the technician review and a complete buckle replacement will be required to complete the repair.

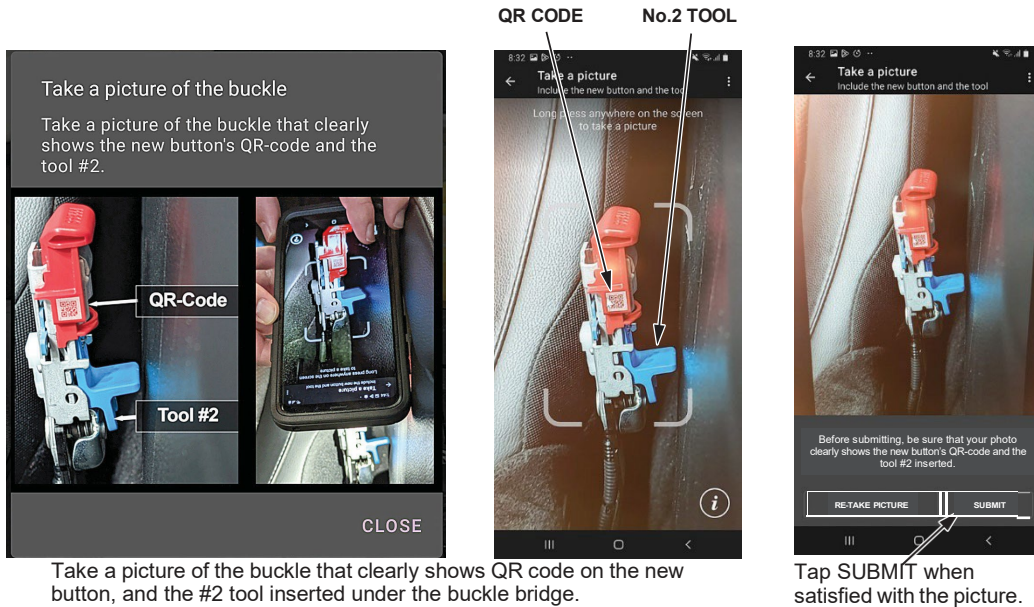

2. After the picture uploads successfully, the application provides steps to prepare the buckle for the second verification picture taken from the door side of the buckle:

- Remove the #2 tool.
- Press down on the button to reset the latch.
- Confirm the new button is securely attached.

3. New button verification (Door Side).



Insert the Seatbelt Tongue into the buckle and confirm it is latched. Pull up on the seatbelt to provide a clear view of the buckle.



Frame the picture using the app's cut-out guide. Long press on the screen to capture the picture.



Tap SUBMIT when satisfied with the picture

NOTE: The application will analyze the photo and provide feedback.

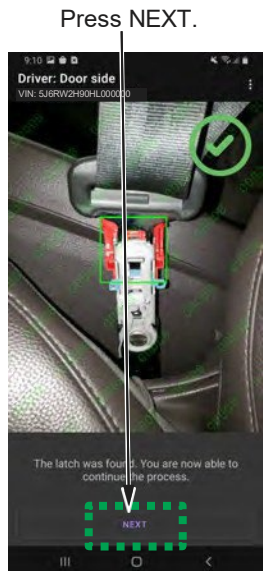

A green check mark will be displayed in the top right of the screen when the application is able to verify the repair.

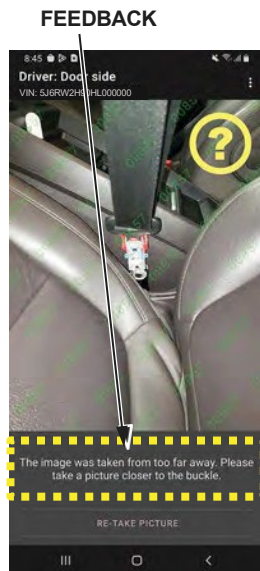

If the application is unable to verify the repair, a "?" or "X" will be displayed in the top right corner of the screen and feedback will be provided on the bottom of the screen to assist in improving the next picture retake.



When an "X" is displayed, it will be recorded by the strike counter at the bottom of the screen. If a fifth strike is issued, the application will proceed to the buckle replacement path.

NOTE: If the application returns ? or X frequently, refer to Tips and Trick # 6 and #7.

4. New button verification (Console Side).

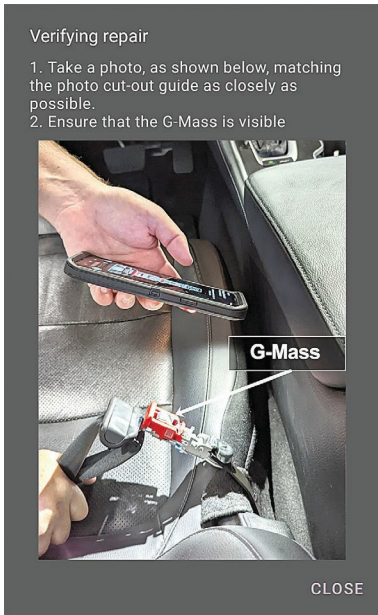

With the buckle still latched, pull down on the buckle and frame the picture using the application's cut-out guide.

Make sure the G-MASS is visible. Long press on the screen to capture the picture.

Tap SUBMIT when satisfied with the picture.

5. After tapping SUBMIT the application will process the picture.



A green check mark will be displayed in the top right of the screen when the application is able to verify the repair.



If the application is unable to verify the repair, a "?" or "X" will be displayed in the top right corner of the screen and feedback will be provided on the bottom of the screen to assist in improving the next picture retake.

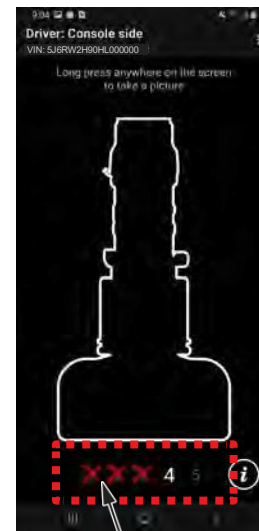

When an "X" is displayed, it will be recorded by the strike counter at the bottom of the screen. If a fifth strike is issued, the application will proceed to the buckle replacement path.

NOTE: If the application returns ? or X frequently, refer to Tips and Trick step 6 and 7.

6. Final Function Check.

- Make sure the harness wire is correctly set inside the groove before installing the lower buckle cover.



- Install the buckle cover.

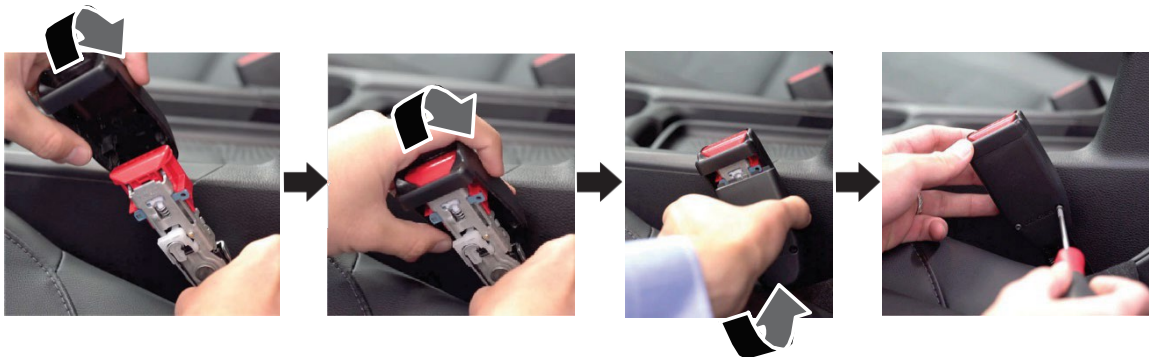

- If a screw is lost or misplaced, replacement screws are available P/N 90121-TLA-305.
- Confirm the buckle is functioning correctly by inserting the tongue into the latch and tugging on the seatbelt to confirm the buckle is securely latched. Unlatch the buckle and repeat the process 3 to 4 times.
- Confirm no additional SRS DTC have been introduced.

BUCKLE LOCATION	BUCKLE DTC	DESCRIPTION
Driver	B0050-11	Short or decreased resistance in the driver's seat belt buckle switch.
Driver	B0050-12	Short to power in the driver's seat belt buckle switch.
Driver	B0050-13	Open or increased resistance in the driver's seat belt buckle switch.
Driver	B0050-2B	Short to another wire harness in the driver's seat belt buckle switch.
Passenger	B0052-11	Short or decreased resistance in the front passenger's seat belt buckle switch.
Passenger	B0052-12	Short to power in the front passenger's seat belt buckle switch.
Passenger	B0052-13	Open or increased resistance in the front passenger's seat belt buckle switch.
Passenger	B0052-2B	Short to another wire harness in the front passenger's seat belt buckle switch.

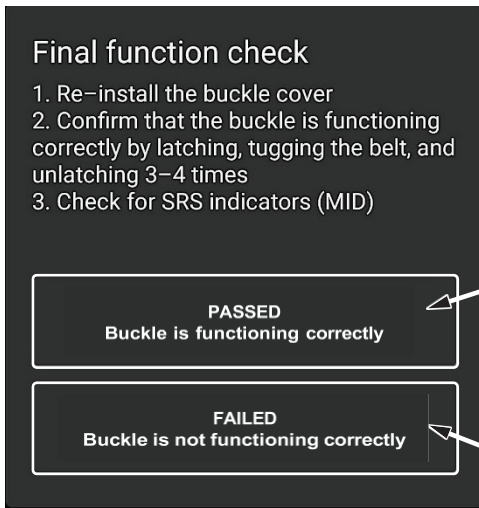

Select PASSED, if the buckle is functioning correctly and no SRS indicators or buckle DTCs have been introduced. (Go to step 7)

Select FAILED, if the buckle is not functioning correctly and/or SRS indicator is now on. (go to Seat Belt Buckle Replacement)

7. In this process, pictures taken are now uploaded and sent to a trained analysts for human verification review. Because each photo is carefully reviewed for proper repair verification, this process may take a few minutes to complete.

NOTE: Do not attempt to exit or refresh the screen.

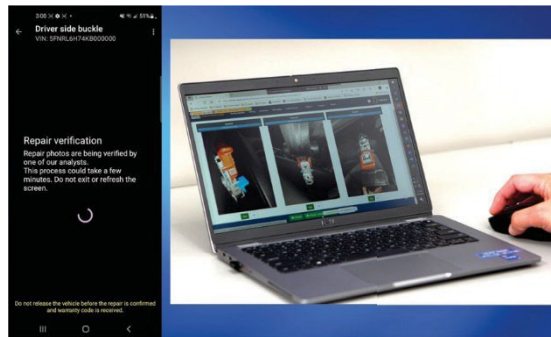
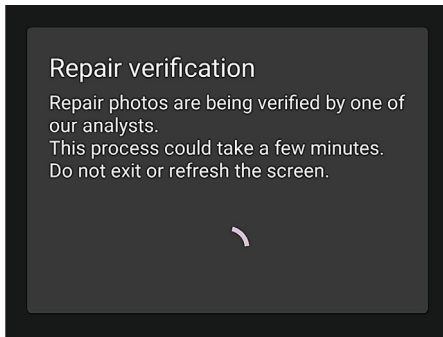

- If the pictures reveal that the repair was performed correctly, a warranty code will be generated and displayed for that repair.

- If the pictures reveal that the repair was performed correctly, a warranty code will be generated and displayed for that repair.

NOTE: For a warranty claim submission, please provide these codes to your Warranty Administrator.

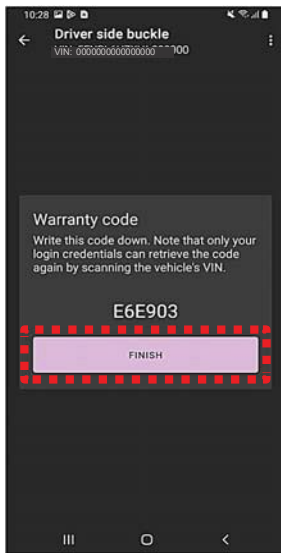

Tap FINISH to return to the Buckle Status Screen.

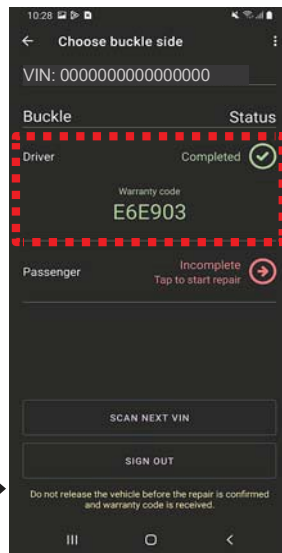

The status for the buckle will display COMPLETED and the warranty code will be displayed.

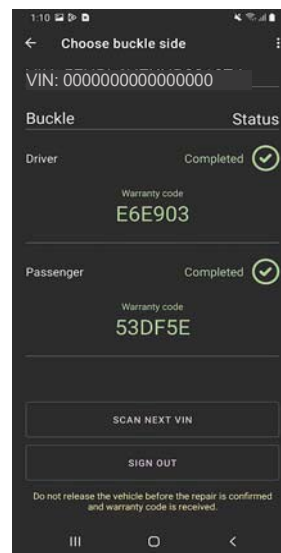

Continue repairs and do not release the vehicle until COMPLETED status is displayed for both the driver and passenger buckles.

- If the analyst is unable to judge that the repair was performed correctly, a complete buckle replacement will be required.

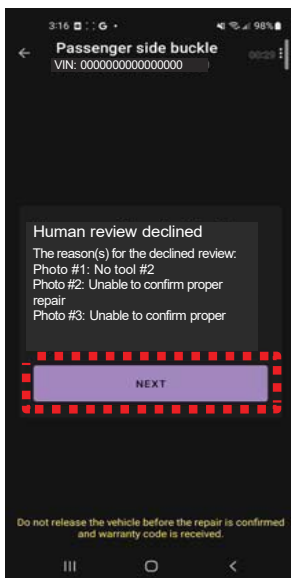

The application will display "Human review declined" and provide the reason(s) for the declined review.

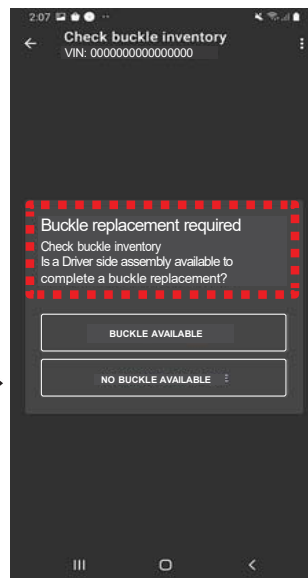

The application will advance to the Buckle Replacement Procedure. (go to Seat Belt Buckle Replacement.)

- Do not release vehicle before the repair is confirmed and the buckle status shows Completed for both the driver and passenger side.
- See Tips and Tricks step 5 for information on retrieving warranty codes.

SEAT BELT BUCKLE REPLACEMENT



Prior to Seat Belt Buckle Replacement, watch this video:

1. Buckle Inventory Check.

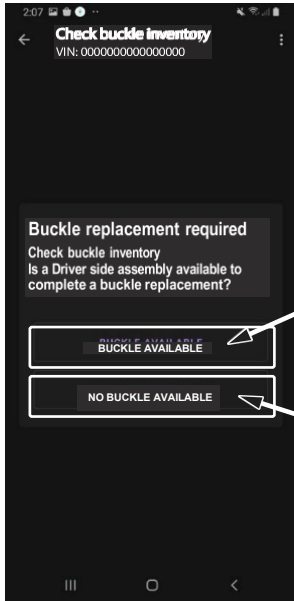

Before making a selection, check your dealer inventory for the buckle assembly that needs to be replaced. (Driver or Passenger side).

Select **BUCKLE AVAILABLE**, if the inventory is available. (go to step 2)

Select **NO BUCKLE AVAILABLE**, if there are no buckles currently available in dealer inventory.

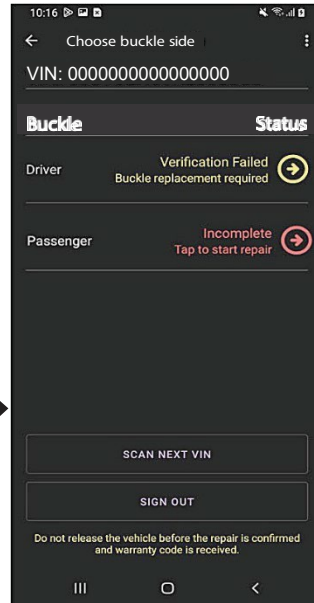

The status for the buckle will display "Verification Failed Buckle replacement required" in yellow. When a buckle becomes available, repeat steps 1-4 of the inspection procedure to get to the Status Screen. Select the yellow arrow to the right of the status to resume the Seat Belt Buckle Replacement Procedure.

2. Scan the new buckle's QR-Code.

NOTE: The QR-Code from the new buckle must be scanned prior to installing.

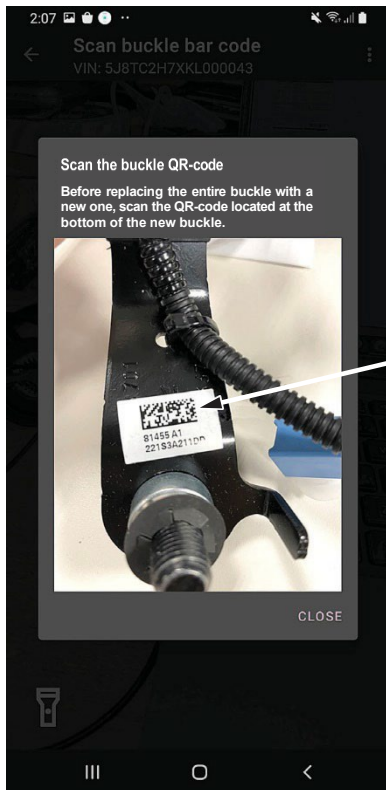

QR CODE

3. Begin Buckle Replacement Process.

NOTE: Do not make a selection until directed to do so in step 17.

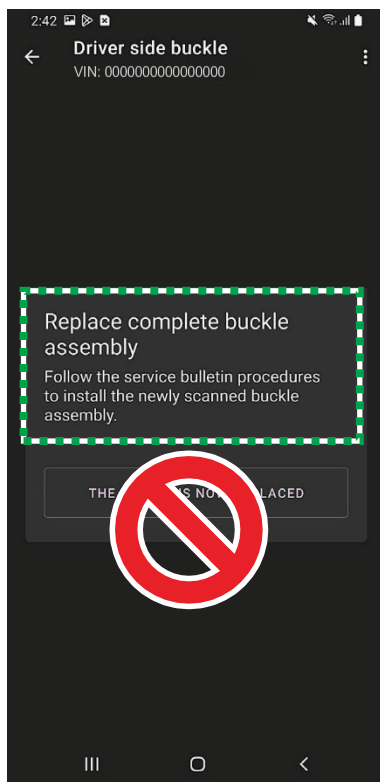

- Adjust the seat to the forward most position and remove the rear seat bolts.

REAR SIDE

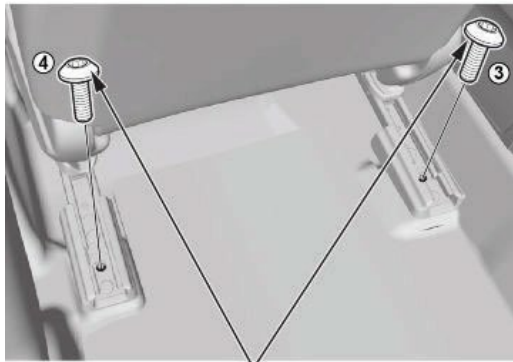

BOLTS
43 N·m (32 lb-ft)

- Adjust the seat to the rear most position, raise the seat height to the highest position (if equipped) and recline the seat back until the head restraint is behind the B-pillar.

Adjust seat-back angle with
headrest behind B-pillar.



Raise seat height to the
highest position (if equipped)

- Disconnect and isolate the cable with the 12 volt battery sensor from the 12 volt battery.

NOTE:

- Keep the driver's door open, and after turning the vehicle to the OFF (LOCK) mode.
- Always disconnect the negative side first.
- To protect the connector from damage, do not hold it when removing the terminal.
- Do not disconnect the 12 volt battery sensor from the cable.
- Wait **3 minutes** before starting work.



NUT
2.9 – 5.9 N.m
(2.1 – 4.4 lb-ft)

NUTS
9.4 N.m (6.9 lb-ft)

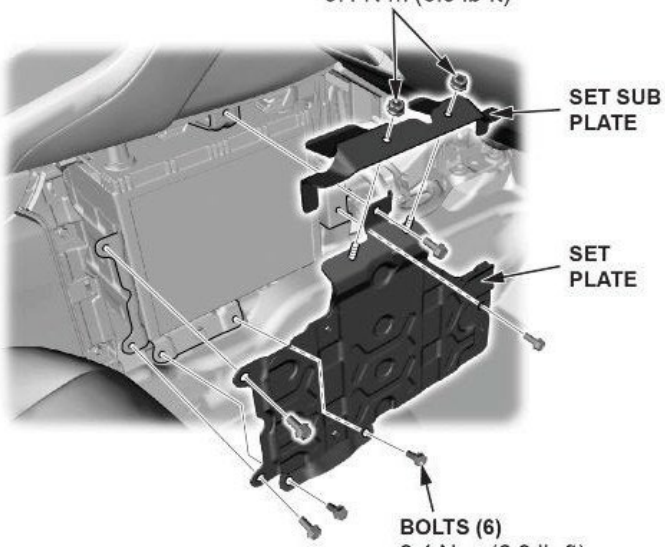

**SET SUB
PLATE**

**SET
PLATE**

BOLTS (6)
9.4 N.m (6.9 lb-ft)

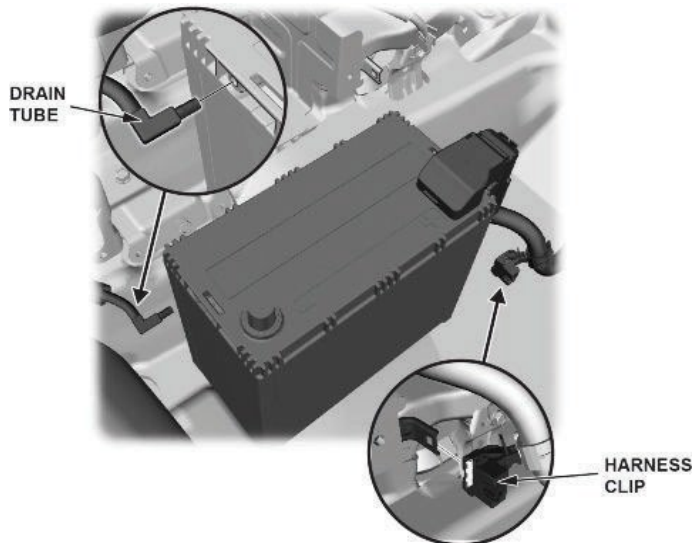

**DRAIN
TUBE**

**HARNESS
CLIP**

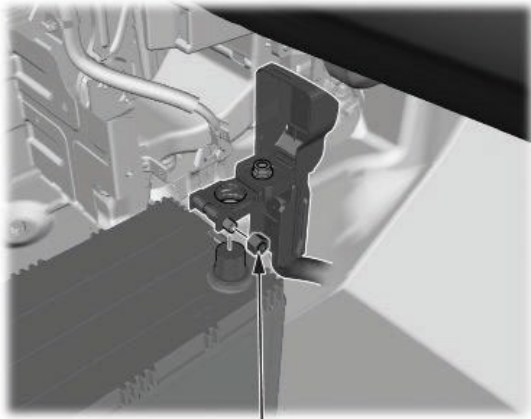

NUT
4.0 – 10 N·m
(3.0 – 7 lb-ft)

7. Remove the front seat bolts.

FRONT SIDE



BOLTS
43 N·m (32 lb-ft)

8. Lift and move the seat back while leaning the seatback into the rear door opening to lay the seat on its side.
NOTE: To prevent scratching/damaging the center console, do not allow the seat rails to contact the center console.



9. With the seat laying on its side, remove the seat belt buckle from the seat frame.

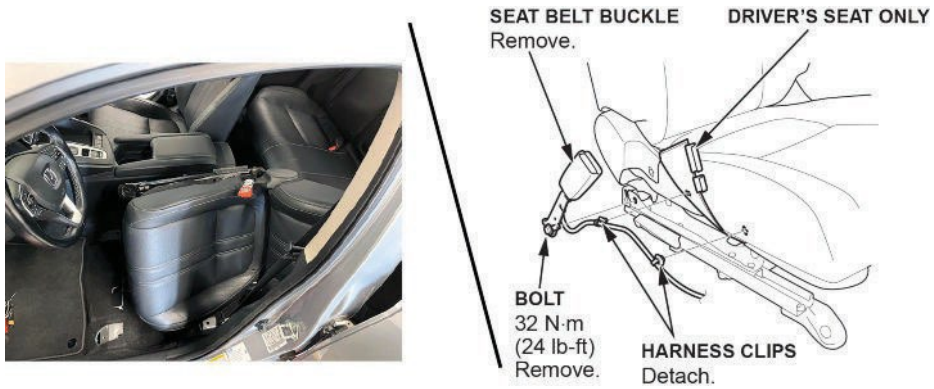

- Detach the harness clip(s) and connector clip(s).

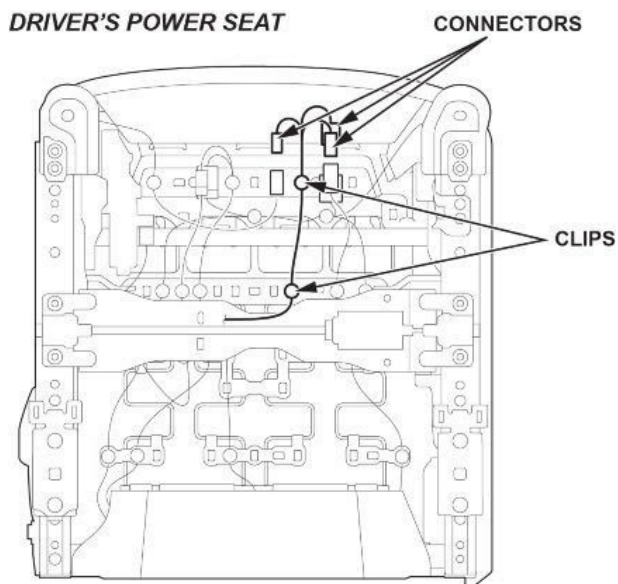
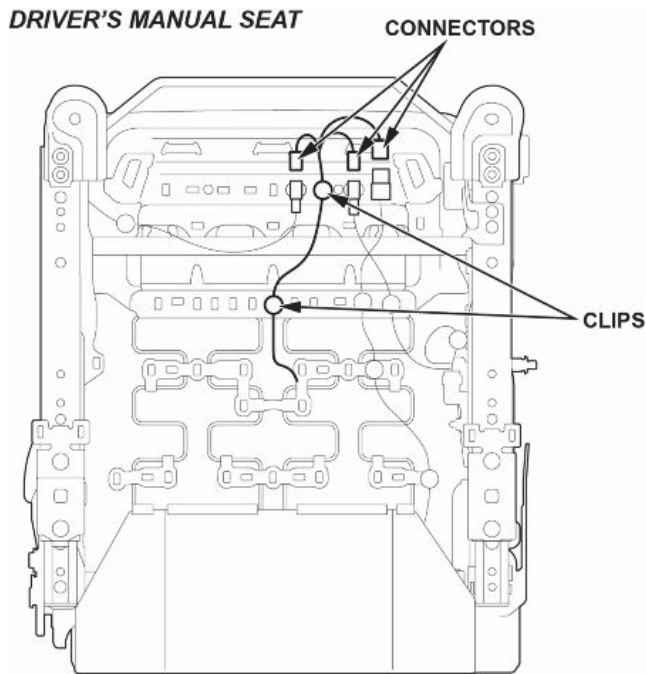

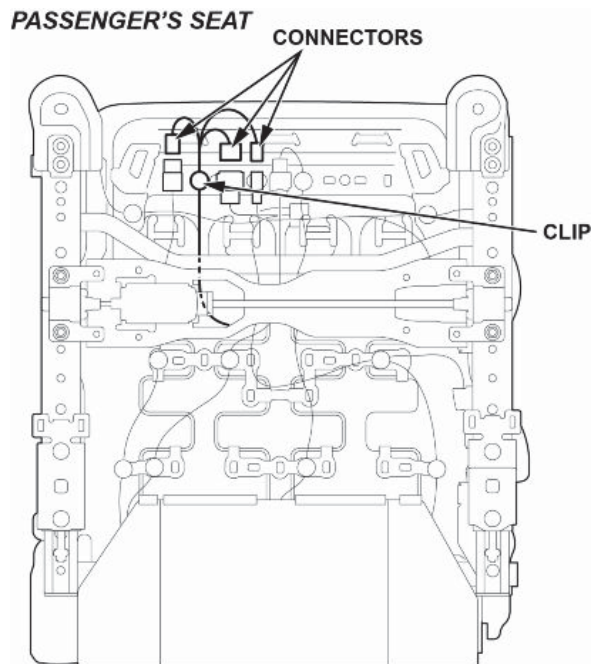

10. Install the seat belt buckle in the reverse order of removal then tighten the seat belt buckle bolt to the specified torque.

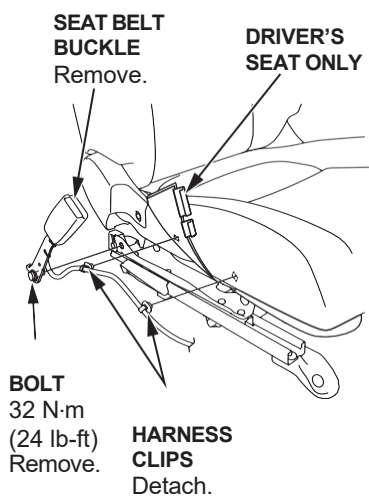

11. Lift and move the seat back into position and tighten the front bolts hand tight.

12. Reconnect the cable with the 12 volt battery sensor to the 12 volt battery.

NOTE: To protect the connector battery sensor from damage, do not hold it when installing the terminal.

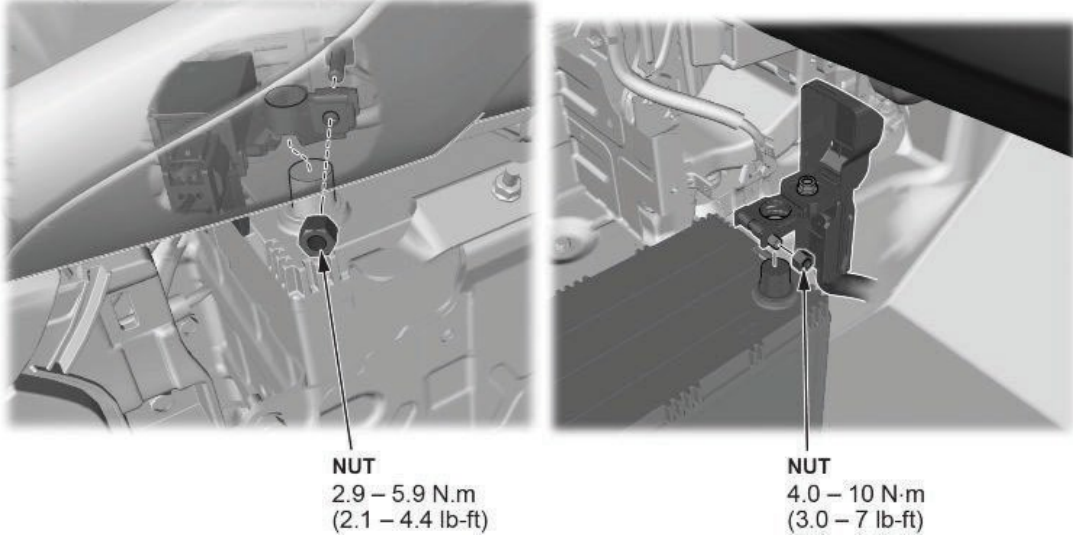

13. Adjust the seat to the front most position and install the rear bolts hand tight.

14. Adjust the seat as needed to tighten the bolts to the specified torque in the sequence shown.

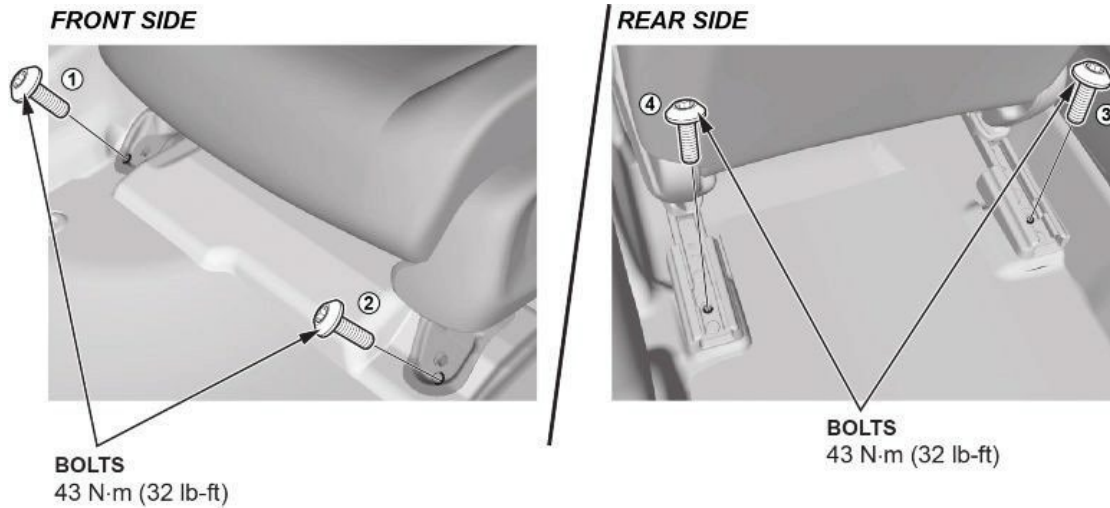

15. Disconnecting the battery causes the steering angle neutral position to be lost. Do the Steering Angle Neutral Position Learning Procedure:

15.1. **Learning with the HDS:**

NOTE:

- If learning can not be completed, refer to the **Check the EPS system** in service information.
- During the learning procedure, pay attention to the following:
 - If you turn the vehicle to the OFF (LOCK) mode while learning, do the learning again from the beginning.
 - Do not lift up the vehicle when you start the engine.
 - Do not rapidly turn the steering wheel.
- Do not press the brake pedal during the Steering Angle Neutral Position Learning Procedure.

15.1.1. Connect the HDS to the DLC located under the driver's side of the dashboard.

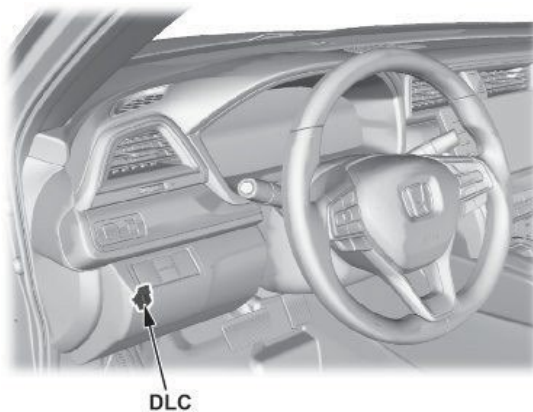

15.1.2. Turn the vehicle to the ON mode, but do not start the engine.

15.1.3. Set the steering wheel in the straight ahead position.

15.1.4. Select the ADJUSTMENT from the ABS/VSA menu with the HDS, then select ALL SENSOR, and follow the screen prompts.

15.2. **Learning method while driving:**

NOTE: Use this method only if road and environmental conditions allows safe operation.

15.2.1. Drive the vehicle and make complete, left and right turns (at intersections) at speeds above 6mph (10 km/h) until the indicators turn off.

NOTE: Situations that make learning difficult shown below:

- Driving on a rough road.
- Driving 6 mph (10 km/h) or less.
- Driving on a sloped road.
- Rapid acceleration and deceleration.

15.2.2. Check that the indicators turn off.

15.3. Learning method while stopped:

15.3.1. Park the vehicle on a flat and level surface.

15.3.2. Start the engine.

15.3.3. Set the steering wheel to the neutral (straight ahead) position.

15.3.4. Turn it one rotation to the left and return it to the original position.

15.3.5. Turn it one rotation to the right and return it to the original position.

15.3.6. Turn it quarter to the left and return it to the original position.

15.3.7. Turn it quarter to the right and return it to the original position.

15.3.8. Turn it quarter to the left and return it to the original position.

15.3.9. Turn it quarter to the right and return it to the original position.

15.3.10. Make sure the indicator is off.

16. If the passenger's side seat belt buckle was replaced, do the following weight sensor operation check:

NOTE:

- Before doing this procedure, clear the DTCs.
- Before doing this procedure, make sure the 12 volt battery is fully charged.
- Make sure the front passenger's seat and all components of the seat are correctly installed.
- Make sure nothing is on the front passenger's seat, including aftermarket seat covers or mats.
- Make sure there is nothing in the front passenger's seat-back pocket.
- Make sure the vehicle is on level ground.
- When you perform this procedure, the vehicle temperature must be between **41- 113 °F (5 - 45°C)**.
- When the vehicle is exposed to intense cold or intense heat, move the vehicle inside, open the windows and moonroof (if equipped), and perform this procedure after one hour or more.
- Do not expose the front passenger's seat to sudden temperature changes.
- Do not use the A/C or the heater.
- Do not touch the front passenger's seat and keep the vehicle stationary during this procedure.
- Do not attach the seat belt tongue into the buckle.
- If possible, do all of these procedures inside.

16.1. Turn the vehicle to the OFF (LOCK) mode.

16.2. Connect the HDS to the DLC located under the driver's side of the dashboard.

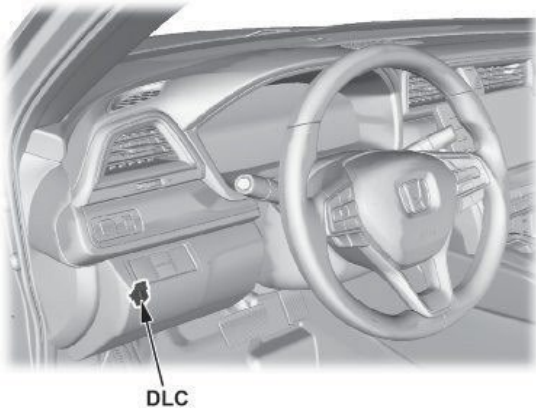

16.3. Turn the vehicle to the ON mode, but do not start the engine.

16.4. Activate the HDS, then make sure the HDS communicates with the PCM and other vehicle systems. If it doesn't, go to the DLC circuit troubleshooting (with ACC) or F-CAN circuit troubleshooting (without ACC).

NOTE: For the models without ACC, if the F-CAN circuit troubleshooting is OK, go to the DLC circuit troubleshooting in service information.

16.5. Do the Front Passenger's Weight Sensor Operation Check

- Before doing this procedure, clear the DTCs.
- Before doing this procedure, make sure the 12 volt battery is fully charged.
- Make sure the front passenger's seat and all components of the seat are correctly installed.
- Make sure nothing is on the front passenger's seat, including aftermarket seat covers or mats.
- Make sure there is nothing in the front passenger's seat-back pocket.
- Make sure the vehicle is on level ground.
- When you perform this procedure, the vehicle temperature must be between **41- 113 °F (5 - 45°C)**.
- When the vehicle is exposed to intense cold or intense heat, move the vehicle inside, open the windows and moonroof (if equipped), and perform this procedure after one hour or more.
- Do not expose the front passenger's seat to sudden temperature changes.
- Do not use the A/C or the heater.
- Do not touch the front passenger's seat and keep the vehicle stationary during this procedure.
- Do not attach the seat belt tongue into the buckle.
- If possible, do the procedures inside.

16.6. Position the front passenger's seat all the way rearward and lowermost (if equipped with the height adjuster), then adjust the seat-back to the forward most position.

NOTE: Do not move the seat from this position until the operation check is completed.

16.7. From System Selection Menu, select SRS, then Data List. In the Data List, select FRONT PASSENGER'S WEIGHT. The weight (T0) of the front passenger's seat is displayed by the HDS. Write this measurement down as "T0" on a piece of paper.

- If the reading on the HDS (T0) is within **±2.1 kg (±4.6 lbs)**, go to step 16.8.
- If the reading on the HDS (T0) is at or not within **±2.1 kg (±4.6 lbs)**, turn the vehicle to the OFF (LOCK) mode, and go to the Front Passenger's Weight Sensor Initialization in service information.

16.8. Prepare a weight between **10 kg (22 lbs)–20 kg (44 lbs)** then measure and note its actual weight (M) with a weight scale.

NOTE:

- The weight scale must be accurate within **1 kg (2 lbs)**.
- The weight must be uniform in shape and size to allow precise placement on the seat.

16.9. Precisely place the prepared weight on the center of the front passenger's seat as shown.

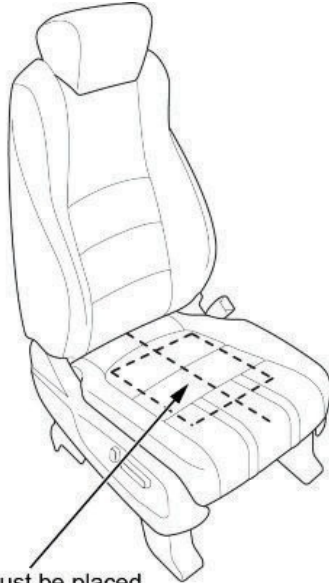

The weight must be placed precisely on the center line of the seat.

16.10. From the Data List, select FRONT PASSENGER'S WEIGHT. The weight (T1) of the front passenger's seat is displayed by the HDS. Write this measurement down as "T1".

16.11. Divide (M) by 2. Write this calculation as "M1" on a piece of paper.

16.12. Calculate the variance between the weight measured by the weight scale and the HDS with the formula:

$$\text{Variance} = ((T1)-(T0)-(M1))$$

T1: Weight measured by the HDS with the weight on the seat.

T0: Weight measured by the HDS with no load on the seat.

M1: Half of the weight measured by the weight scale.

If the variance is within **±2.2 kg (±4.9 lbs)**, initialization is complete.

If the variance is at or not within **±2.2 kg (±4.9 lbs)**, do the following and then go to the Front Passenger's Weight Sensor Initialization in the service information.

16.13. Turn the vehicle to OFF (LOCK) mode.

17. Return to the Buckle Service Application and Press, "THE BUCKLE IS NOW REPLACED". A warranty code will be generated and displayed for that repair.

NOTE: For a warranty claim submission, please provide these codes to your Warranty Administrator.

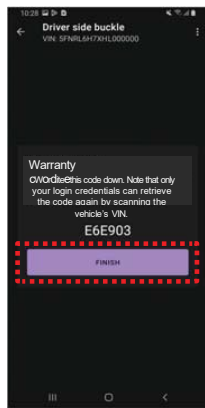
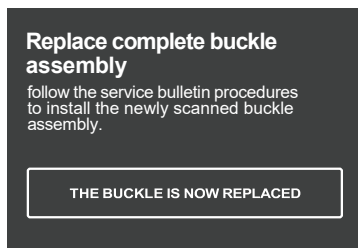

Tap FINISH to return to the Buckle Status Screen

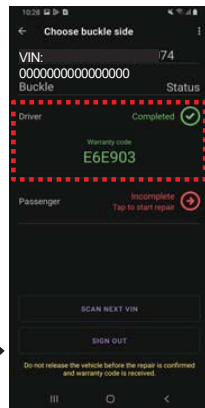

The status for the buckle will display COMPLETED and the warranty code will be displayed.

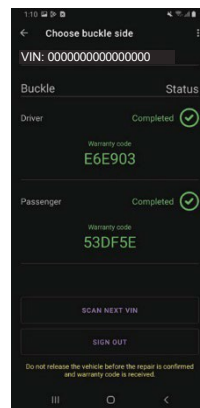

Continue repairs and do not release the vehicle until COMPLETED status is displayed for both the driver and passenger buckles.

TIPS AND TRICKS

Prior to the Seat Belt Buckle Replacement, watch this video:



Here are some tips and tricks to help in successfully completing the repair.

1. To prevent connectivity issues with the Buckle Service APP, it is critical that the repair is done in an area with a strong Wi-Fi signal.
2. During any of the photo verification process, the requirement help screen can be recalled by simply tapping on the icon from the bottom right of the screen.

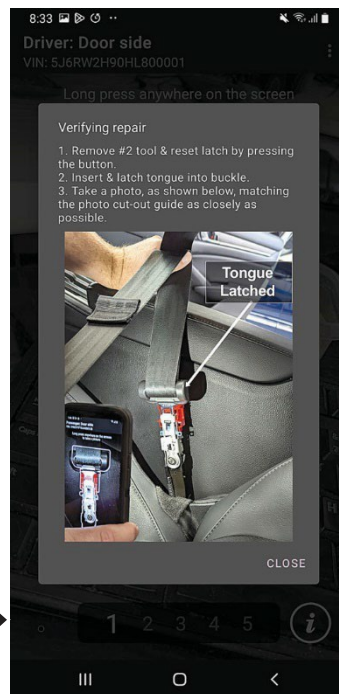
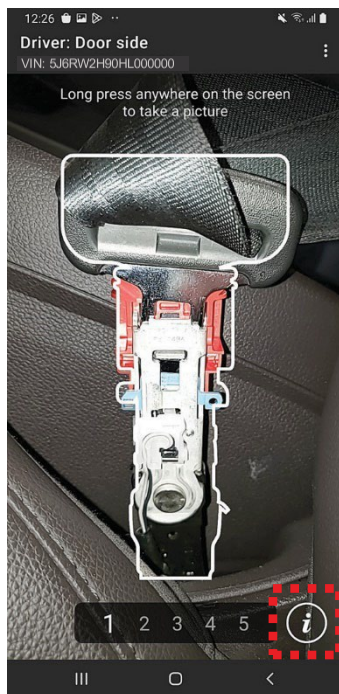
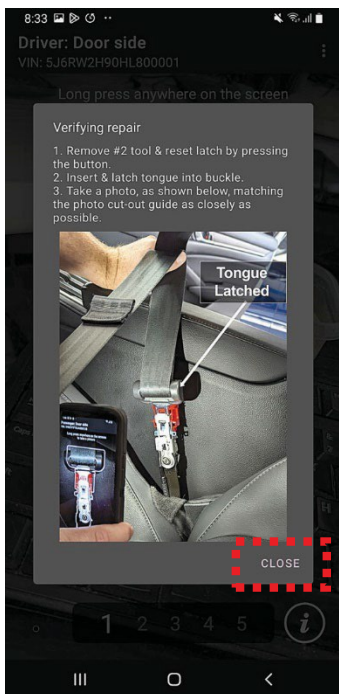

- The device's camera can sometimes have issues focusing. If this happens, turn the flashlight off to refocus by tapping on the flashlight icon from the bottom left of the screen. If turning the flashlight off still does not work, press the back arrow from the top of the screen to restart the process.



- For any technical issues with the Application, the help center contact info can be displayed by pressing the 3 dots from the top right of the APP screen and selecting Contact help center.

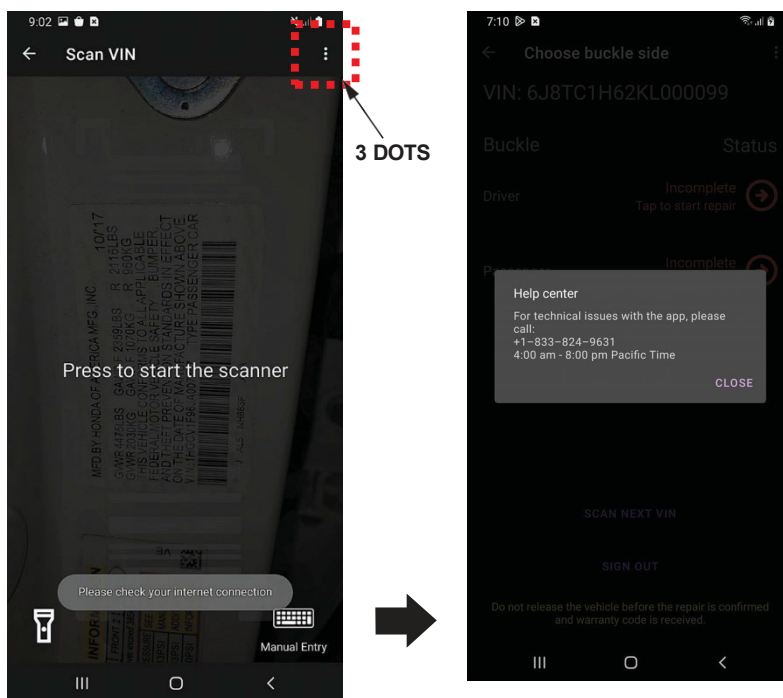

5. Warranty code retrieval.

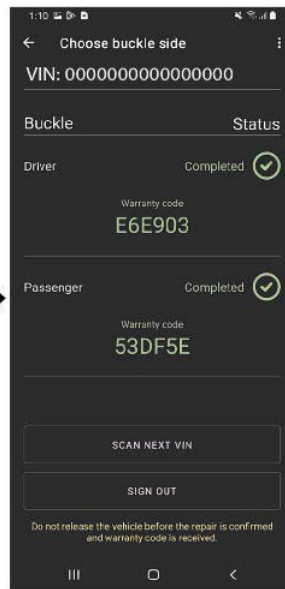
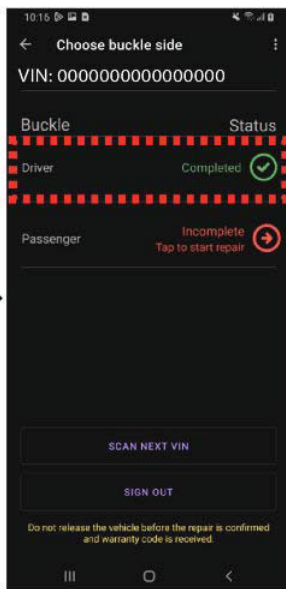
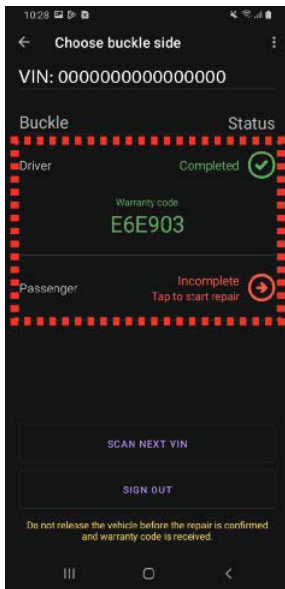



The warranty code for this repair can be retrieved from the buckle status screen at any time by logging into the Buckle Service app using the iN credential of the technician who performed the repair.

The warranty code is NOT displayed on the buckle status screen when using iN credentials that do not match the credential of the technician who performed the repair. Only the "Completed" buckle status is displayed.

Continue repair and do not release the vehicle until "Completed" status is displayed for both the driver and passenger buckles.

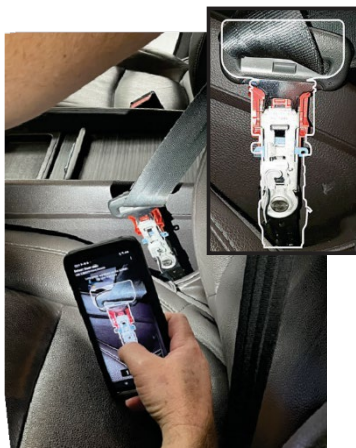
6. Application is unable to verify the repair picture #2 (Latch) or picture #3 (G-mass) - Under certain conditions, the application may have difficulty judging the repair photo. If this occurs, move the camera closer to the buckle and frame the buckle outside the APP's cut-out guide.



If the App returns  or  when the buckle is framed inside the cut-out guide...

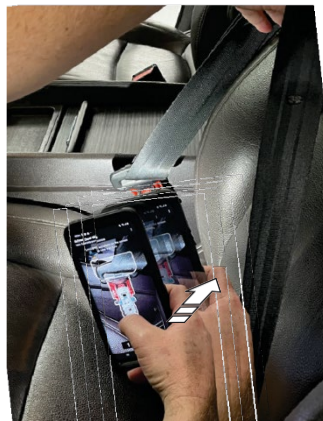

... move the camera closer to frame the buckle outside the cut-out guide.



7. Application is unable to verify the repair Picture #3 – G-mass Camera Angle. Some camera angles make it difficult for the application to judge the repair photo. If this occurs, position the camera making sure the camera is parallel with the face of the buckle as shown below. The pictures to the left illustrate a camera angle taken from the side of the buckle. The pictures on the right illustrate a camera angle taken with the camera parallel with and directly in front of the buckle.

Blue tab is not visible.



Both blue tabs are visible.



Device too close to bolster.

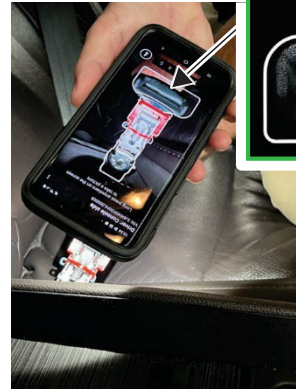

The App may return  or when the buckle is framed inside the cut-out guide...

Move the camera away from the seat bolster, making sure the camera is parallel with buckle and both blue tabs are visible in the picture.

END