



Safety Recall

Code: 97ZZ

Subject	High Voltage (HV) Battery Management Control Module Software															
Release Date	March 29, 2023															
Affected Vehicles	<table border="1"><thead><tr><th>Country</th><th>Beginning Model Year</th><th>Ending Model Year</th><th>Vehicle</th><th>Vehicle Count</th></tr></thead><tbody><tr><td>USA</td><td>2021</td><td>2021</td><td>ID4</td><td>20,904</td></tr><tr><td>CAN</td><td>2021</td><td>2021</td><td>ID4</td><td>1,433</td></tr></tbody></table> <p><i>Check Campaigns/Actions screen in ELSA on the day of repair to verify that a VIN qualifies for repair under this action. ELSA is the <u>only</u> valid campaign inquiry & verification source.</i></p> <ul style="list-style-type: none">✓ Campaign status must show "open."✓ If ELSA shows other open action(s), inform your customer so that the work can also be completed at the same time the vehicle is in the workshop for this campaign.	Country	Beginning Model Year	Ending Model Year	Vehicle	Vehicle Count	USA	2021	2021	ID4	20,904	CAN	2021	2021	ID4	1,433
Country	Beginning Model Year	Ending Model Year	Vehicle	Vehicle Count												
USA	2021	2021	ID4	20,904												
CAN	2021	2021	ID4	1,433												
Problem Description	The high voltage (HV) battery management control unit may reset or, in rare events, the pulse inverter may be deactivated while driving. If the HV battery management control unit resets while driving, the vehicle's electric motor will not be supplied with power for the duration of the reset. This may lead to a loss of propulsion without warning, and may increase the risk of a crash.															
Corrective Action	Update software for the HV battery management control unit and the pulse inverter control unit. Additionally, certain vehicles included in this recall that were produced within a specific time period may also receive non-recall-related hardware and software improvements free of charge. These updates can include installing a more robust 12-volt battery, as well as software improvements and multiple security patches, as well as an updated version of the owner's manual.															
Precautions	If the recall condition described above occurs in the vehicle, the driver will receive an immediate warning in the instrument cluster. Customers experiencing this situation are advised to contact their authorized Volkswagen dealer without delay for an appointment to have the vehicle diagnosed. As a reminder, the vehicle owner's manual contains important information regarding the vehicle's warning lights and messages. We encourage customers and anyone who drives the vehicle to review the owner's manual to become familiar with the types of vehicle indicators, warnings and messaging they may see.															
Code Visibility	On February 06, 2023, the campaign code was applied to affected vehicles.															
Owner Notification	Owner notification will take place in March 2023. Owner letter examples are included in this bulletin for your reference.															
Additional Information	Please alert everyone in your dealership about this action, including Sales, Service, Parts and Accounting personnel. Contact Warranty if you have any questions.															

IMPORTANT REMINDER ON VEHICLES AFFECTED BY SAFETY & COMPLIANCE RECALL:

New Vehicles in Dealer Inventory: It is a violation of federal law for a dealer to deliver a new motor vehicle or any new or used item of motor vehicle equipment (including a tire) covered by this notification under a sale or lease until the defect or noncompliance is remedied. By law, dealers must correct, prior to delivery for sale or lease, any vehicle that fails to comply with an applicable Federal Motor Vehicle Safety Standard or that contains a defect relating to motor vehicle safety.

Pre-Owned Vehicles in Dealer Inventory: Dealers should not deliver any pre-owned vehicles in their inventory which are involved in a safety or compliance recall until the defect has been remedied.

Dealers must ensure that every affected inventory vehicle has this campaign completed before delivery to consumers.

Fill out and affix Campaign Completion Label (CAMP 010 000) after work is complete. *Labels can be ordered at no cost via the Compliance Label Ordering portal at www.vwhub.com.*

Parts Information

Parts Control Type:
Free Order Parts will be managed by Free Order

Initial Allocation:
YES Dealers will be sent an initial allocation prior to customer notification. If no initial allocation was received, please reference the Repair Projection Tool (below) to view your potential VIN population.

Repair Projection Tool:
(right click to open)

Criteria	Quantity	Part Number	P.O.C. Part Description	Ordering Method
01	1	000-915-105-FA DSP	12V Battery	POC Drop Ship

NOTE

Batteries have a 15 month threshold to be used in vehicles. Please make sure you are using batteries in first in first out (FIFO) order, reducing the risk of obsolescence.

Interstate standard return process regarding expiration dates are to be used for this action.

NOTE

The specified part numbers reflect the status at the start of this action. Interim updates made in ETKA can cause a listed part number to become unavailable. In this case, the new part number specified in ETKA should be used.

Owner's Manual Ordering Information

Ordering Method: Technical Literature Ordering Center	Owner's manual kits can be ordered using the "Technical Literature Ordering Center" found on vwclub.com.
--	--

Initial Allocation: YES	<p><u>IMPORTANT:</u></p> <p>Dealers expected to do repairs were sent an initial allocation prior to customer notification.</p> <p>The allocation included a delivery of owner's manuals and a separate delivery of tow hook supplements.</p> <p><u>If additional quantities are needed</u>, please order the part numbers listed below.</p>
--	--

Criteria	Quantity	Part Number	Description
03	1	11A012723SG	US English Kit (US English owner's manual + English tow hook supplement)
04	1	11A012722DG	CAN English Kit (CAN English owner's manual + English tow hook supplement)
05	1	11A012742DG	CAN French Kit (CAN French owner's manual + French tow hook supplement)

NOTE

Canadian dealers must provide one of these documents in the language of the customer's choice.

Claim Entry Instructions

The labor times listed here may differ from the labor operations and labor times listed in ELSA.

After campaign has been completed, enter claim as soon as possible to help prevent work from being duplicated elsewhere. Attach the ELSA screen print showing action open on the day of repair to the repair order.

If customer refused campaign work:

- ✓ U.S. dealers: Submit request via WISE under the *Campaigns/Update/Recall Closure* option.
- ✓ Canada dealers: Upload the repair order [signed by customer] to Volkswagen WIN/Operations/Campaign Closure.

Service Number	97ZZ
Damage Code	0099
Parts Vendor Code	WWO
Claim Type	Sold vehicle: 7 10 Unsold vehicle: 7 90
Causal Indicator	Mark BATTERY* as causal part if 12V battery is replaced Mark labor as causal if 12V battery is not being replaced
Vehicle Wash	Do not claim wash under this action
Vehicle Loaner (USA ONLY)	See special claiming instructions for rental/loaner claiming. <i>NOTE: A second claim must be entered for rental/loaner claiming</i>
Vehicle Loaner (Canada ONLY)	Loaner/rental coverage cannot be claimed under this action. Please refer to the Volkswagen Service Loaner Program to determine loaner eligibility.
<p>Vehicles may have more than one criteria.</p> <p>Complete and claim all applicable criteria on <u>one</u> claim.</p>	

Continued on next page

Criteria I.D.	01		
	Update software. Replace 12V battery.		
	LABOR		
	Labor Op	Time Units	Description
	2706 89 50	10	Connect battery charger
	9710 25 99	60	Update ICAS3 with USB
	2706 01 99	10	Check 12V battery
	2706 55 99	60	Replace 12V battery
	2706 89 99	10	Charge 12V battery (if necessary)
	0150 00 00	Time stated on diagnostic protocol(s)	Perform software update SVM, software configuration SVM and complete all necessary GFF test plans
	<p><i>NOTE: If the software update and related GFF work is performed on more than one diagnostic session, the multiple GFF logs can be added together.</i></p> <p><i>Claims will stop for review if the max allowed GFF time is exceeded. Ensure the GFF logs are added together correctly. For example, two logs from the same diagnostic session are not allowed.</i></p>		
	2706 02 99	25 TU per bus sleep	Perform up to four bus sleep procedures
	0121 00 04	10	Test drive
	PARTS		
	Quantity	Part Number	Description
	1.00	000915105FADSP	BATTERY*

Criteria I.D.	02		
	Update software.		
	LABOR		
	Labor Op	Time Units	Description
	2706 89 50	10	Connect battery charger
	0150 00 00	Time stated on diagnostic protocol(s)	Perform software update SVM, software configuration SVM and complete all necessary GFF test plans
	<p><i>NOTE: If the software update and related GFF work is performed on more than one diagnostic session, the multiple GFF logs can be added together.</i></p> <p><i>Claims will stop for review if the max allowed GFF time is exceeded. Ensure the GFF logs are added together correctly. For example, two logs from the same diagnostic session are not allowed.</i></p>		
	2706 02 99	25 TU per bus sleep	Perform up to four bus sleep procedures
	0121 00 04	10	Test drive

Continued on next page

Criteria I.D.	03 or 04 or 05 (owner's manual kit) NOTE: All owner's manual kits include the necessary owner's manuals <u>and</u> the owner's manual supplement.				
	Provide owner's manual kit.				
	OUTSIDE MATERIAL				
	Crit.	Qty	Part Number	Description	Amount
	03	1	11A012723SG	USEGLISHKIT	\$7.76 (USD) \$10.59 (CAD)
	04 or 05	1	11A012722DG	CANENGLISHKIT	\$16.97 (USD) \$22.90 (CAD)
		1	11A012742DG	CANFRENCHKIT	\$29.73 (USD) \$40.13 (CAD)
<i>NOTE: Vehicles with criteria 04 and 05 can claim either the CANENGLISHKIT or the CANFRENCHKIT.</i>					

Vehicle Loaner (USA ONLY)	Enter vehicle loaner claim as a separate, second claim Allowed time = up to 2 days		
	Claim Type	1 SP	
	Service Number	X182	
	Damage Code	0055	
	Damage Location	Blank	
	Parts Vendor Code	K21	
	Outside Labor Operation	X182US00 (mark as causal)	Enter dollar amount on rental/loaner invoice (Up to \$53 per day)

The information in this document is intended for use only by skilled technicians who have the proper tools, equipment and training to correctly and safely maintain your vehicle. These procedures are not intended to be attempted by "do-it-yourselfers," and you should not assume this document applies to your vehicle, or that your vehicle has the condition described. To determine whether this information applies, contact an authorized Volkswagen dealer. ©2023 Volkswagen Group of America, Inc. and Volkswagen Canada. All Rights Reserved.

Customer Letter Example (USA)

This notice applies to your vehicle: <MODEL YEAR> <BRAND> <CARLINE>, <VIN>

NHTSA: 23V040

Subject: Safety Recall 97ZZ - High Voltage (HV) Battery Management Control Module Software

Dear Volkswagen Owner,

This notice is sent to you in accordance with the National Traffic and Motor Vehicle Safety Act. Volkswagen has decided that a defect, which relates to motor vehicle safety, exists in certain 2021 model year Volkswagen ID.4 vehicles. Our records show that you are the owner of a vehicle affected by this action.

What is the issue?	The high voltage (HV) battery management control unit may reset or the pulse inverter may be deactivated while driving. If the HV battery management control unit resets while driving, the vehicle's electric motor will not be supplied with power for the duration of the reset. This may lead to a loss of propulsion without warning, increasing the risk of a crash.
What will we do?	<p>To correct this defect, your authorized Volkswagen dealer will update software for the HV battery management control unit and the pulse inverter control unit. This work will take up to eleven (11) hours to complete and will be performed for you free of charge. Please keep in mind that your dealer may need additional time for the preparation of the repair, as well as to accommodate their daily workshop schedule.</p> <p>Additionally, certain vehicles included in this recall that were produced within a specific time period may also receive non-recall-related hardware and software improvements free of charge. These updates can include installing a more robust 12-volt battery, as well as software improvements and multiple security patches, as well as an updated version of the owner's manual.</p>
What should you do?	Please contact your authorized Volkswagen dealer without delay to schedule this recall work. To set up an appointment online, please visit www.vw.com/find-a-dealer .
Important Note for Car-Net® Subscribers	If your vehicle is currently enrolled in Car-Net and the Car-Net app is downloaded to your phone or other mobile device, you may receive several notifications during the update process as your dealer is performing this recall work. This is normal and should not be a cause for concern.
Precautions you should take	<p>If the recall condition described above occurs in your vehicle, the driver will receive an immediate warning in the instrument cluster. Customers experiencing this situation are advised to contact their authorized Volkswagen dealer without delay for an appointment to have the vehicle diagnosed.</p> <p>As a reminder, your vehicle owner's manual contains important information regarding your vehicle's warning lights and messages. We encourage you and anyone who drives your vehicle to review the owner's manual to become familiar with the types of vehicle indicators, warnings and messaging you may see.</p>
Lease vehicles and address changes	If you are the lessor and registered owner of the vehicle identified in this action, the law requires you to forward this letter immediately via first-class mail to the lessee within ten (10) days of receipt. If you have changed your address or sold the vehicle, please fill out the enclosed prepaid Owner Reply card and mail it to us so we can update our records.
Can we assist you further?	If your authorized Volkswagen dealer fails or is unable to complete this work free of charge within a reasonable time, or if you should have any questions about this communication, please reach out to us using your preferred method of communication at www.vw.com/contact or by calling us at 800-893-5298.
Checking your vehicle for open Recalls and Service Campaigns	To check your vehicle's eligibility for repair under this or any other recall/service campaign, please visit www.vw.com/owners/recalls and enter your Vehicle Identification Number (VIN) into the Recall/Service Campaign Lookup tool.

If you still cannot obtain satisfaction, you may file a complaint with: The Administrator, National Highway Traffic Safety Administration, 1200 New Jersey Avenue, SE., Washington, DC 20590; or call the toll-free Vehicle Safety Hotline at 1-888-327-4236 (TTY: 1-800-424-9153); or go to <http://www.safercar.gov>.

We apologize for any inconvenience this matter may cause; however we are taking this action to help ensure your safety and continued satisfaction with your vehicle.

Sincerely,

Volkswagen Customer Protection

Customer Letter Example (Canada)

This notice applies to your vehicle: <MODEL YEAR> <BRAND> <CARLINE>, <VIN>

Transport Canada Recall: 2023-034

Subject: Safety Recall 97ZZ - High Voltage (HV) Battery Management Control Module Software

Dear Volkswagen Owner,

This notice is sent to you in accordance with the requirements of the *Motor Vehicle Safety Act*. This is to inform you that your vehicle may contain a defect that could affect the safety of a person. Our records show that you are the owner of a vehicle affected by this action.

What is the issue?

The high voltage (HV) battery management control unit may reset or the pulse inverter may be deactivated while driving. If the HV battery management control unit resets while driving, the vehicle's electric motor will not be supplied with power for the duration of the reset. This may lead to a loss of propulsion without warning, increasing the risk of a crash.

What will we do?

To correct this defect, your authorized Volkswagen dealer will update software for the HV battery management control unit and the pulse inverter control unit. This work will take about eleven (11) hours to complete and will be performed for you free of charge. Please keep in mind that your dealer may need additional time for the preparation of the repair, as well as to accommodate their daily workshop schedule.

Additionally, certain vehicles included in this recall that were produced within a specific time period may also receive non-recall-related hardware and software improvements free of charge. These updates can include installing a more robust 12-volt battery, as well as software improvements and multiple security patches, as well as an updated version of the owner's manual.

What should you do?

Please contact your authorized Volkswagen dealer without delay to schedule this recall work.

Important Note for Car-Net® Subscribers

If your vehicle is currently enrolled in Car-Net and the Car-Net app is downloaded to your phone or other mobile device, you may receive several notifications during the update process as your dealer is performing this recall work. This is normal and should not be a cause for concern.

Precautions you should take

If the recall condition described above occurs in your vehicle, the driver will receive an immediate warning in the instrument cluster. Customers experiencing this situation are advised to contact their authorized Volkswagen dealer without delay for an appointment to have the vehicle diagnosed.

As a reminder, your vehicle owner's manual contains important information regarding your vehicle's warning lights and messages. We encourage you and anyone who drives your vehicle to review the owner's manual to become familiar with the types of vehicle indicators, warnings and messaging you may see.

Lease vehicles and address changes

If you are the lessor and registered owner of the vehicle identified in this letter, you shall forward this letter (and any subsequent notice, if applicable) to the lessee within ten (10) days of receipt. If you have changed your address or sold the vehicle identified in this letter, please fill out the enclosed prepaid Owner Reply Card and mail it to us so we can update our records.

Can we assist you further?

If your authorized Volkswagen dealer fails or is unable to complete this work free of charge within a reasonable time, please contact Customer Relations, Monday through Friday from 8AM to 8PM EST by phone at 1-800-822-8987 or via our "Contact Us" page at www.vw.ca.

We apologize for any inconvenience this matter may cause; however we are taking this action to help ensure your safety and continued satisfaction with your vehicle.

Sincerely,

Volkswagen Customer Protection

Repair Overview

! IMPORTANT

If Safety Recall 93O2 or Service Action 93P7 are also open for the VIN being worked on, the 97ZZ must be performed before completing the 93O2 or 93P7.

! NOTE

A checklist is included at the end of this document, in one of the attachment tabs in ELSA and on ServiceNet.

The checklist can be printed and used to guide the technician through all of the repair steps.

Appendix A includes the software table and will show what the updated software versions should be after completing this repair in its entirety.



Vehicles assigned Criteria 01:

1. USB Flash of ICAS3
2. Replace 12V battery
3. Execute measure code F313
4. Perform bus sleep procedure
5. Execute measure code S313
6. Execute GFF program "Replace 12V battery"
7. Perform bus sleep procedure
8. Execute GFF program "Learn VKMS"
9. Perform manual basic settings
10. Adjust service interval display
11. Execute all GFF programs listed in the test plan
12. Replace owner's manual literature
13. Print out owner's manual supplement

Vehicles assigned Criteria 02:

1. Execute measure code F313
2. Perform bus sleep procedure
3. Execute measure code S313
4. Perform bus sleep procedure
5. Execute GFF program "Learn VKMS"
6. Perform manual basic settings
7. Adjust service interval display
8. Execute all GFF programs listed in the test plan
9. Print out owner's manual supplement

The information in this document is intended for use only by skilled technicians who have the proper tools, equipment and training to correctly and safely maintain your vehicle. These procedures are not intended to be attempted by "do-it-yourselfers," and you should not assume this document applies to your vehicle, or that your vehicle has the condition described. To determine whether this information applies, contact an authorized Volkswagen dealer. ©2023 Volkswagen Group of America, Inc. and Volkswagen Canada. All Rights Reserved.

NOTE

- These repair instructions may differ from the labor operations and labor times listed in ELSA.
- Damages resulting from improper repair or failure to follow these work instructions are the dealer's responsibility and are not eligible for reimbursement under this action.
- This procedure must be read in its entirety prior to performing the repair.
- Due to variations in vehicle equipment and options, the steps/illustrations in this work procedure may not identically match all affected vehicles.
- Diagnosis and repair of pre-existing conditions in the vehicle are not covered under this action.
- When working during extreme temperatures, it is recommended that the vehicle be allowed to acclimate inside the shop to avoid temperature-related component damage/breakage.

Required Tools

 <p>Battery Tester/Charger -VAS5908-</p>	 <p>Diagnostics Interface W-LAN -VAS6154A-</p>
 <p>Diagnostic Tester -VAS6150D- (or higher)</p>	 <p>USB Module -VAS6154/4A- (included with -VAS6154A-)</p>

Required USB Drive *(this is required only for vehicles assigned Criteria 01)*

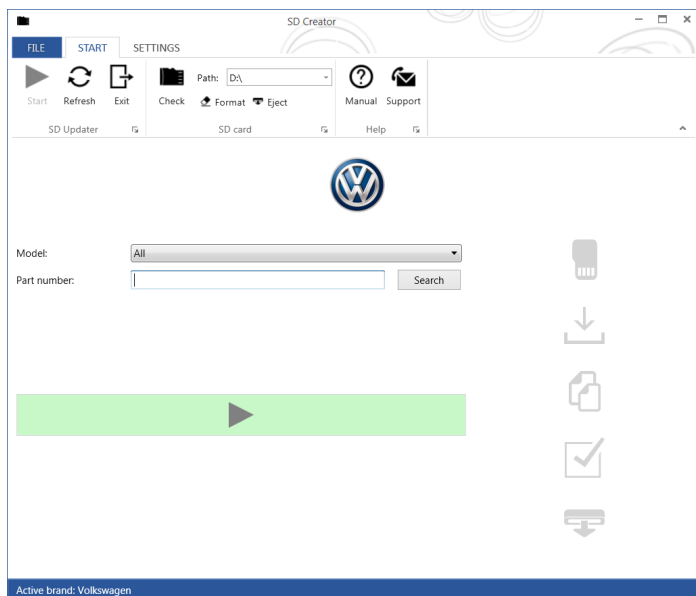

- The required software will have to be downloaded onto a USB (or USB-C) drive using the SD Creator program
- **Reference the latest version of TSB 2054866 for additional information on the use of the SD Creator program.**
- **Use ONLY a 32 GB USB stick.**

NOTE

The required USB drives cannot be ordered via the parts ordering system, they must be created using the SD Creator program.

The required USB drive is a servicing material. Therefore the cost of the USB drive will not be reimbursed.

The USB drive can be used for future software updates.

NOTE

If the search for the software part number returns no result, check if the certificate is valid.

Go to Settings and select the current, valid certificate used in ODIS.

Software Part Number

3G0.919.360.RK

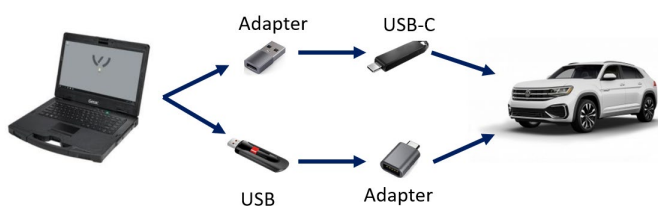

General information for creating the USB stick:

- The Infotainment system uses a USB-C input.
- If the software is downloaded onto a USB drive, a USB to USB-C adapter will be required.
- If the software is downloaded onto a USB-C drive, a USB-C to USB adapter will be required since the VAS tester does not have a USB-C drive.
- **Use ONLY a 32 GB USB stick.**
- USB type C (at least USB 2.0), reading/writing speed: at least 40 MB/s / 10 MB/s.
- USB type A including type C (at least USB 2.0), reading/writing speed: at least 40 MB/s / 10 MB/s.
- Do not use a USB hub (USB distributor to use several USB devices on one USB port) to install the software update.

Repair Instruction

Section A - Check for Previous Repair

TIP

If Campaign Completion label is present, no further work is required.

Applicable criteria ID(s)	Campaign/Action Status
01 ← 2	Open ← 1

EXAMPLE

Campaign/Action	Start	Designation
→ 3	2015-11-10	W-SERV_ACT -
	2018-12-13	RECALL -
	2017-05-16	A-RECALL -

EXAMPLE

- Enter the VIN in Elsa and proceed to the “Campaign/Action” screen.

TIP

On the date of repair, print this screen and keep a copy with the repair order.

- Confirm the Campaign/Action is open <arrow 1>. If the status is closed, no further work is required.
- Note the Applicable Criteria ID <arrow 2> for use in determining the correct work to be done and corresponding parts associated.

CRITICAL REPAIR STEP

 **STOP!** 

If multiple software update Campaign/Actions are open, they must be performed in order of the Start date <arrow 3>. The oldest should be performed first, unless noted otherwise.

- **Proceed to Section B**

NOTE

If Safety Recall 93O2 or Service Action 93P7 are also open for the VIN being worked on, the 97ZZ must be performed before completing the 93O2 or 93P7.

Section B – Repair Prerequisites

NOTE

Prior to launching the VAS Diagnostic Tester and starting an update, ensure the following conditions are met;

- ✓ **The ODIS software is completely up to date.**
 - Refer to the “Alerts” section on ServiceNet home page for the current ODIS version.
- ✓ **The battery charger is connected to the vehicle battery and remains connected for the duration of the software update.**
 - Battery voltage must remain above 12.5 volts for the duration of the software update. Failure to do so may cause the update to fail, which could result in damage to the control module. Control modules damaged by insufficient voltage will not be covered.
- ✓ **The screen saver and power saving settings are off.**
 - Failure to do so may result in the tester entering power save mode during the software update, which could result in damage to the control module.
- ✓ **The VAS Diagnostic Tester is plugged in using the supplied power adapters.**
 - Under no circumstances should the tester be used on battery power alone during the software update. Failure to do so may result in the tester powering off during the update, which could result in damage to the control module.
- ✓ **The VAS Diagnostics Interface MUST ONLY be connected to the tester with a USB cable.**
 - Performing a software update using a Bluetooth or WiFi connection increases the risk of losing connection during the update, which could result in damage to the control module. It also greatly increases the time required to perform the update. Requests for additional time or parts will be denied if the GFF log shows the update was performed using Bluetooth or WiFi.

WARNING

Radiator Fan(s) may cycle ON high speed during the Update Process! There is a serious risk that personal injury may result if contact is made with spinning fan blades. Keep hands and all objects away from Radiator Fan(s) during Update Process!

TIP

To Update-Programming using SVM, review and follow instructions in Technical Bulletin 2014603: *Software Version Management (SVM) Operating Instructions*.

The SVM Process must be completed in its entirety so the database receives the update confirmation response. A warranty claim may not be reimbursed if there is no confirmation response to support the claim.

NOTE

- Damages resulting from improper repair or failure to follow these work instructions are the dealer's responsibility and are not eligible for reimbursement under this action.
- Diagnosis and repair of pre-existing conditions in the vehicle are not covered under this action.

NOTE

- All campaign software updates should be completed during a single, standalone ODIS Diagnostic Session. You must fully complete this campaign and send all logs before beginning any other campaigns or operations.
- If there are any ODIS "Hot-Fix" patches installed, they must be removed from the scan tool before beginning this operation. ODIS "Hot-Fix" patches may affect the update process.

Before starting the software update, the following conditions must be met:

- Criteria 01 vehicles - 32 GB USB drive created using SD Creator (see above instructions). **NOTE: no other size USB drive will work for the ICAS3 update.**
- ODIS Service version MUST be at **V11.0.0** – Diagnostic Content **2.47.5** or higher. **Older versions can result in longer software flash times. Requests for additional time due to longer flash times when using older ODIS versions will be denied.**
- ODIS Feedback must be set up correctly:
 - See communication: Offboard Diagnostic Information System Service (ODIS Service), Number: **VOS-22-06** / Subject: Dedicated Email Server Configuration & Feedback Settings / Date: Feb. 1, 2022
- Dealership's internet firewall settings must meet the specified requirements.
 - See communication: Diagnostic Device Hardware & Windows®, Number: **VHW-22-15** / Subject: VAS Diagnostic Device Firewall Settings / Date: December 19, 2022
- ODIS user must have SFD access.
 - See communication: Offboard Diagnostic Information System Service (ODIS Service), Number: **VOS-21-08** / Subject: ODIS Login – SFD Functions / Date: Mar. 11, 2021
- Windows Power Options must be set according to the ODIS tester setup directions:
 - See communication: Diagnostic Device Hardware & Windows®, Number: **VHW-22-13** / Subject: Change Power Options in Windows® 10 / Date: Nov. 1, 2022
 - The "Device Power Management" sections from the VAS 6150X Diagnostic Laptop – Unpacking and Setup Instructions can also be referenced.
- Only one key can be in the vehicle when performing this software flash.
- The vehicle key's battery must be ok.
- Any additional keys must be a minimum of 20 meters away from the vehicle.
- The car MUST NOT be hooked up to a high-voltage charger.
- If the 12V battery is being replaced, the new 12V battery must have sufficient charge (see Step 2 for further information).
- This work will take 7 hours or more.
- If the work steps have to be interrupted for any reason, the best stopping point is at one of the bus sleep steps.



⚠ CRITICAL REPAIR STEP

STOP STOP!

Before starting programming, it is essential to perform the following actions for the -VAS5908- battery charger.

The battery charger's default setting will switch the charger off automatically after a period of time. To prevent this, the following must be carried out.

Switch it OFF and then ON again each time the charger is connected.

The battery charger's display must have switched off before it's restarted.

The charging time can be changed in the charger's settings menu (access code = 6161). Refer to the owner's manual for further information. **DO NOT** change any settings that will damage the charger or the vehicle.

- Connect battery charger -VAS5908-.
- When connecting the charger to the battery, connect the positive cable to the positive charging terminal for the battery and connect the negative cable to the grounding lug on the chassis. **DO NOT** connect the ground cable directly to negative terminal of the battery.

! NOTE

If the customer is enrolled in Car-Net and they have the app downloaded on their phone, they may receive several notifications during the update process.

⚠ CRITICAL REPAIR STEP

STOP STOP!

- Check for pre-existing faults.
- If any of the modules being updated are offline, the communication issue must be addressed prior to starting this procedure. See Appendix A for software table.
- Any module with a "Faulty Control Module" fault *that cannot be cleared*, must be addressed prior to starting the flash. The flash may fail for the affected control module.
- Diagnosis and repair of pre-existing conditions are not covered under this action.

NOTE

- The service interval display may be reset by the software configuration. The current service interval must be read out first and rechecked in Step 10 *after* the software updates are complete.
- It is also possible that the service interval could be reset on a previous service visit if a software configuration was carried out on the vehicle. Therefore, the service interval should be compared to the vehicle's service records. If there is a discrepancy, the service interval values will have to be adjusted accordingly.
- After the software updates are complete, the adaptation channels will also change:
 - Pre-flash:
 - \$0541 (distance driven since the last inspection AND time since the last inspection)
 - Post-flash:
 - \$0548 (distance driven since the last inspection)
 - \$0549 (time since the last inspection)

- Using Operating mode "OBD", check and record the 005F adaptation channel \$0541 for the current service interval.

Control modules Results

005F - Information electronics 1 (UDS / ISOTP / 10A035842E / 0792 / H20 / EV_MUICASSAFEPart / 001001) DTC memory

Adaptation/parameter	RDID	Current value	Entry	Unit
▼ [VO]_service_intervall	\$0541			
Inspection, distance until next inspection		16,090		km
Inspection, distance driven since the last inspection		2,000		km
Inspection, time until next inspection		365		d
Inspection, time since the last inspection		51		d

Filter:

Apply Restore Reset all

005F - ANP

Step 1 – USB Flash of ICAS3 (approximate time = 35 minutes)

NOTE: this step is required only for vehicles assigned Criteria 01

- Ensure the battery charger is connected.
- Ensure there is nothing connected to the OBD diagnosis connection.

! NOTE

The ignition must remain on during the entire flashing process.

- **The hazards must remain on.**
- **The driver door must remain open.**
- **Buckle the seat belt into the driver seat belt buckle.**

! NOTE

Observe the ignition status often. Even with the door open, seat belt buckled and hazards on, it may be possible that the ignition turns off on its own. If this occurs, turn the ignition back on and the update should continue.

- Place the vehicle key over the reader coil in the center console cup holder.
- Any additional keys must be a minimum of 20 meters away from the vehicle.



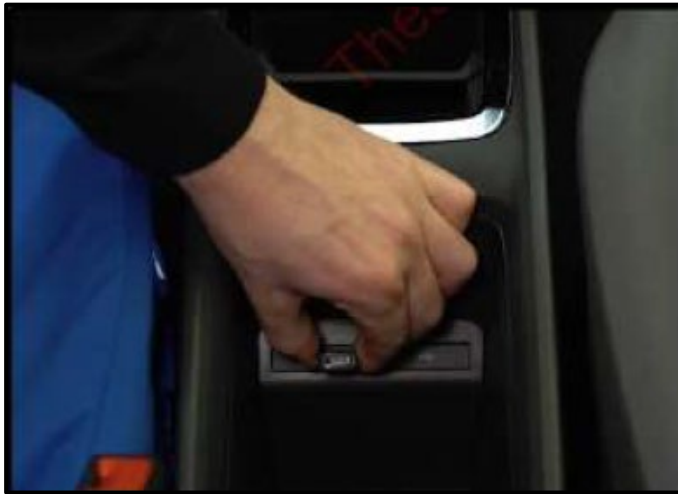

- Insert the USB drive into one of the USB ports.
- Turn the ignition ON.

NOTE

The radio display may display “No playable content” when the ignition is turned on. This is normal. DO NOT remove the USB drive from the USB port.



- The update will start on its own after about two minutes.
- During the update, the instrument cluster display will change multiple times.

NOTE

Observe the ignition status often. Even with the door open, seat belt buckled and hazards on, it may be possible that the ignition turns off on its own.



NOTE

If update does not start after five minutes, turn ignition off, remove USB and restart from the beginning.

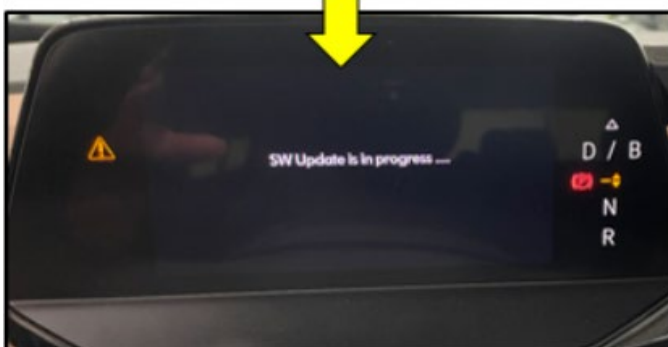

CAUTION

Unless an error has occurred, the USB should never be removed from the USB port while the software update is in progress.

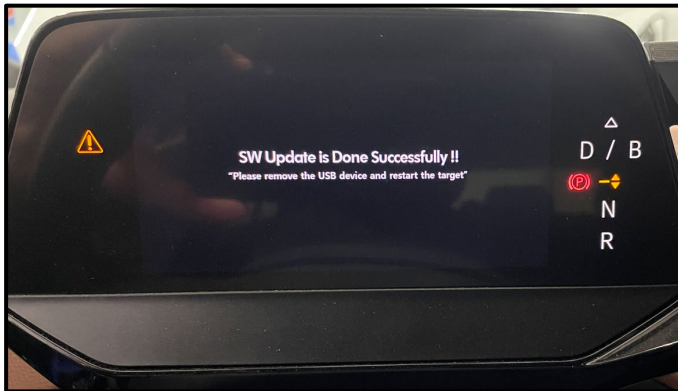
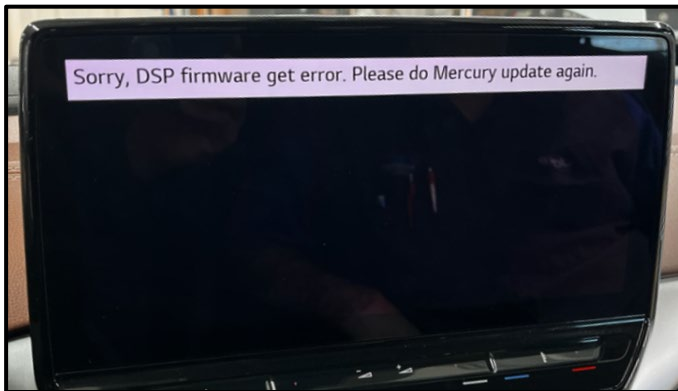

NOTE

If **“Updating CPU...”** message appears for longer than 40 minutes, or if any other error message occurs, restart the update:

Turn off ignition

Remove USB

Reset ICAS3:

- Open driver door
- Remove fuse SC30 for at least 10 seconds, reinstall fuse and reattempt update from the beginning.

If the update still does not complete, recreate the USB using the SD Creator and restart from the beginning.

- The software update is complete when the message shown appears.
- Turn the ignition OFF.
- Once the update is complete, remove the USB drive from the USB port.

NOTE

The successful update message may remain, even if the ignition is switched OFF and back ON.

NOTE

The instrument cluster may remain off, even though the update is complete. If the cluster is off after 40 minutes, cycle the ignition off and back on. The successful message should now appear.

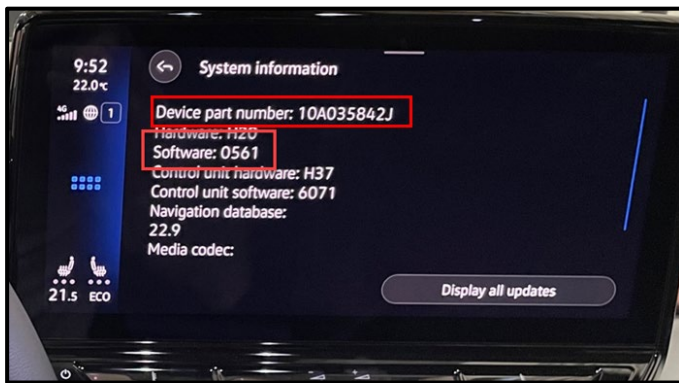

- Check SW version on infotainment display.

! NOTE

If SW version did not update to 0561, or if the Device part number did not change to 10A035842J:

Turn off ignition

Remove USB

Reset ICAS3:

- Open driver door
- Remove fuse SC30 for at least 10 seconds, reinstall fuse and reattempt update from the beginning.

If the update still does not complete, recreate the USB using the SD Creator and restart from the beginning.

! NOTE

If a diagnostic session was started, address 005F and address 8125 must be re-identified before performing the software update in Step 3.

Failure to do so can result in error code ERP0215E when the SVM is attempted in Step 3.

Proceed to Step 2 for replacing the 12V battery.

Step 2 – Replacing 12V Battery

NOTE: this step is required only for vehicles assigned Criteria 01

WARNING

Leaking battery acid.

Risk of acidic chemical burns on the body and corrosion on the vehicle.

- Wear protective gloves, clothing and eyewear.
- The battery must not be tilted.
- Neutralize sulfuric acid as fast as possible for example using soapy water.

WARNING

Oxyhydrogen gas escaping due to charging and degassing.

Risk of explosion

- Prevent generating sparks.
- Take care to avoid short circuits.
- No open fire.
- Do not smoke.
- No open flames.
- Discharge the static electricity, quickly touch the door striker.
- Only perform battery procedures in well-ventilated locations.
- Pay attention to the correct side of the bleed hole.

WARNING

Danger of explosion when checking, charging or jump starting the battery.

- Do not check or charge a battery when the “ALI (Acid Level Indicator)” has no color or is bright yellow. Do not give a jump start.

⚠ CRITICAL REPAIR STEP

STOP STOP!

Before replacing the 12V battery

There is a possibility that the 12V on-board electrical system will continue to be supplied with power by the HV battery and DC/DC converter if the brake pedal is not pressed. When the brake pedal is pressed, the contactors of the HV battery are opened.

Briefly press the brake pedal.

Wait two minutes before starting the 12V battery replacement.

Ensure the ignition is off before replacing the 12V battery.

- Unfortunately, in individual cases there is the possibility that in preparation for this campaign there may have been an above average storage of the 12V battery and, as a result, a sufficient charge level can no longer be ensured.
- Therefore, with sufficient time before starting an update, check the charge level of the battery to be fitted using no-load voltage measurement.
- If the voltage is greater than or equal to 12.5V, then the charge of the battery that took place during the USB update is sufficient.
- If the voltage is between 12.3V and 12.5V then the battery must be charged for at least 6 hours in advance. If the voltage is less than 12.3V, check the battery with a VW approved battery tester and proceed according to the specification of the tester.

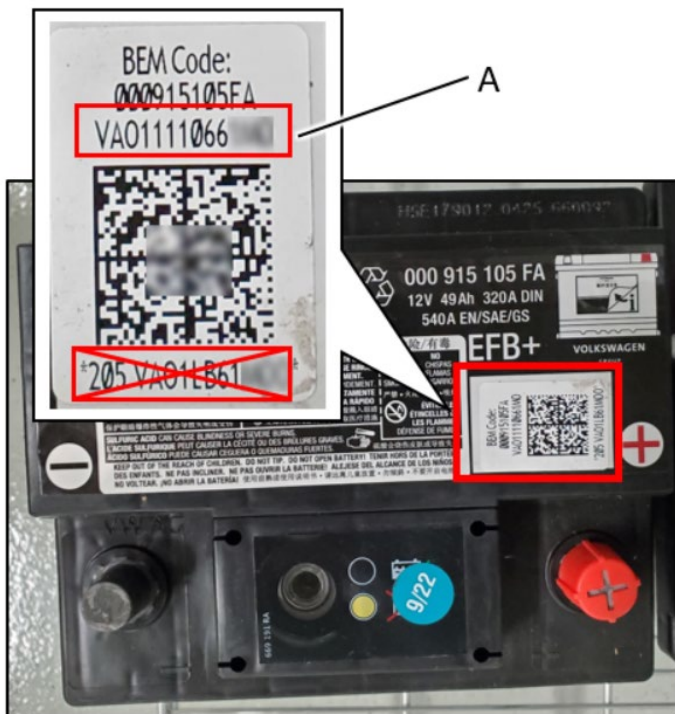

Part Number	Part Description
000-915-105-FA DSP	12 Volt Battery

- When installing the 12V battery, record the following from both the NEW and the OLD 12V batteries:
 - Serial number <A>
 - Battery capacity
 - Battery manufacturer
- This will be required later when performing the 12V battery replacement test plan.

The information in this document is intended for use only by skilled technicians who have the proper tools, equipment and training to correctly and safely maintain your vehicle. These procedures are not intended to be attempted by "do-it-yourselfers," and you should not assume this document applies to your vehicle, or that your vehicle has the condition described. To determine whether this information applies, contact an authorized Volkswagen dealer. ©2023 Volkswagen Group of America, Inc. and Volkswagen Canada. All Rights Reserved.

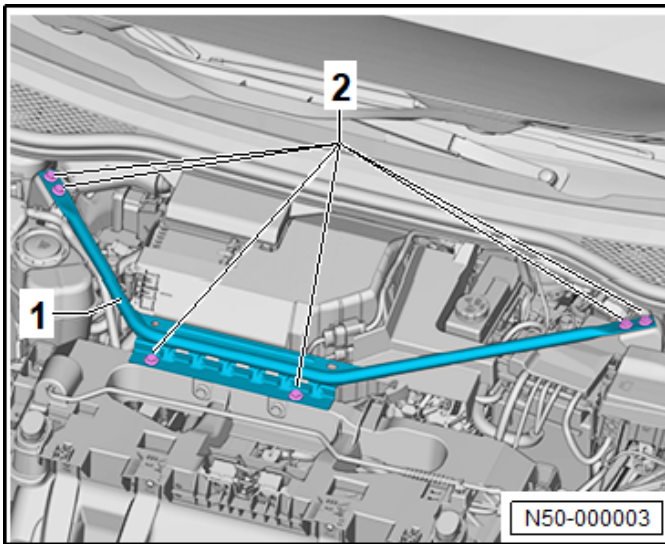

- Remove the bolts <2>.
- Remove the impact member <1>.

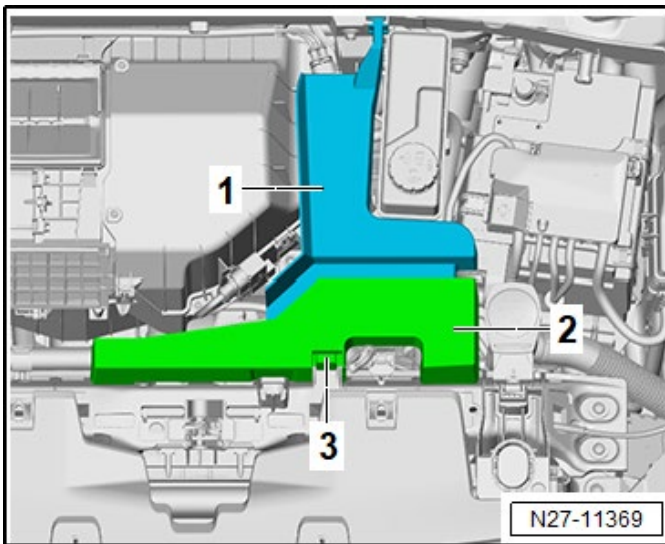

- Release the hook <3>.
- Remove the high-voltage connection cover <2>.



- When removing the high-voltage connection cover <1> the cover has to be lifted up at the connection to the firewall in the <direction of arrow>.

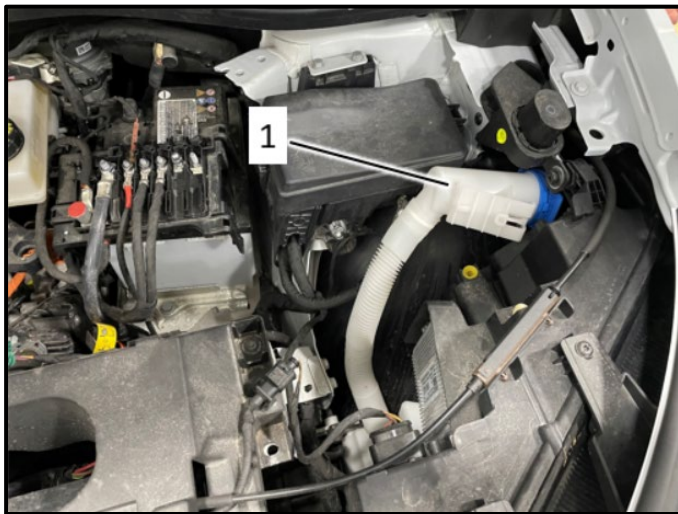

- The washer fluid filler neck will have to be unclipped and moved to the side.

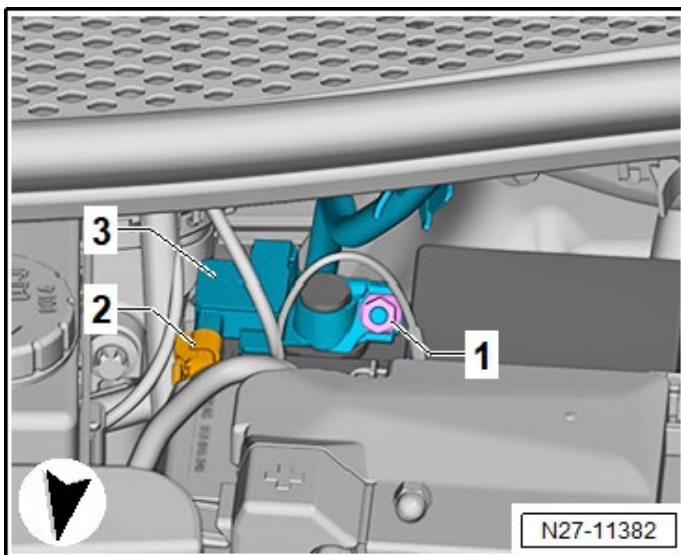

- Open the negative terminal cover above the battery monitoring control module <3>.
- Loosen the nut <1> several turns and remove the battery monitoring control module <3> from the battery negative terminal.
- Disconnect the connector <2> from the Battery Monitoring Control Module -J367-.
- Wait 1 minute.
- Check the voltage of the 12V vehicle electrical system using a commercially available voltmeter.
- The voltage must be 0V.

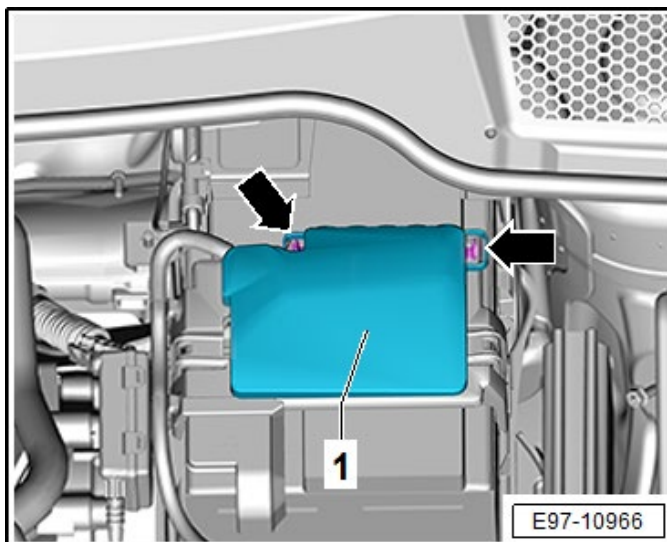

- Release the hooks <arrows>.
- Remove the cover <1>.

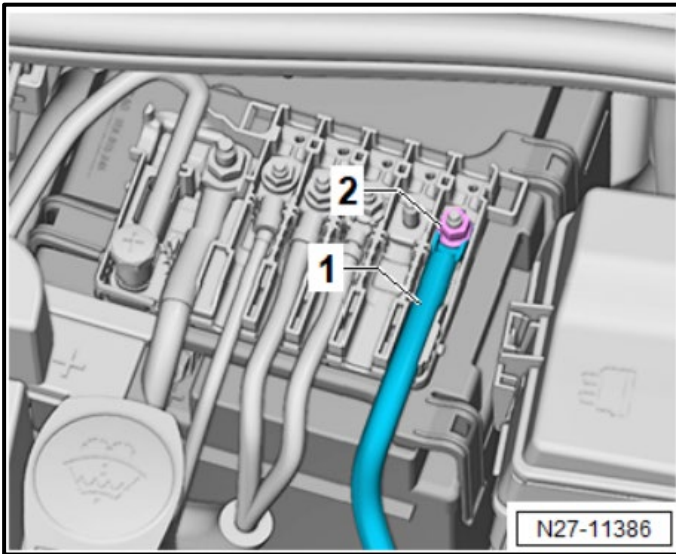

- Loosen the nut <2>.
- Remove the wire <1>.

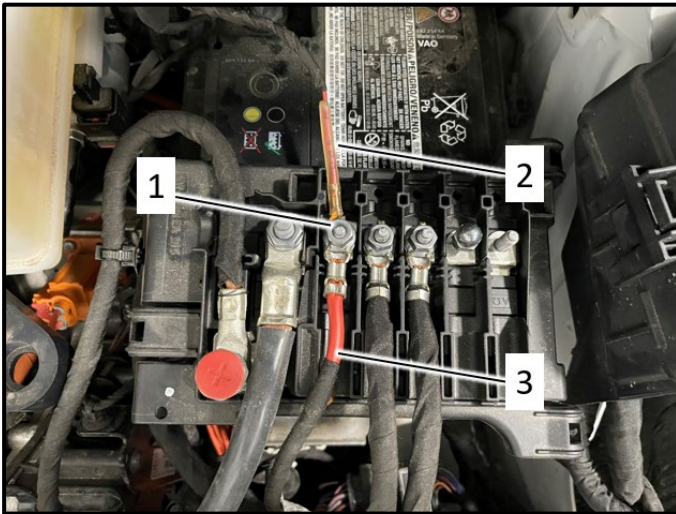

- Loosen the nut <1>.
- Remove wires <2> and <3>.

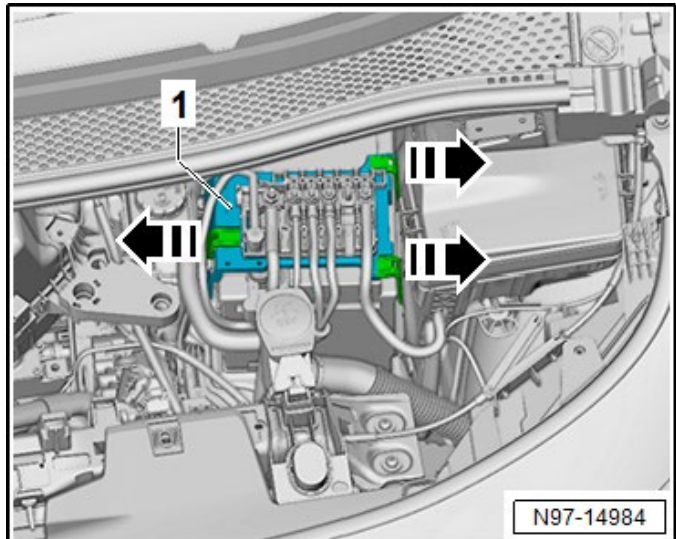

- Release the retaining straps for the bracket for fuse panel A <1> in the direction of <arrow>.
- Remove the bracket for fuse panel A <1> and move it to the side with the wires still connected.

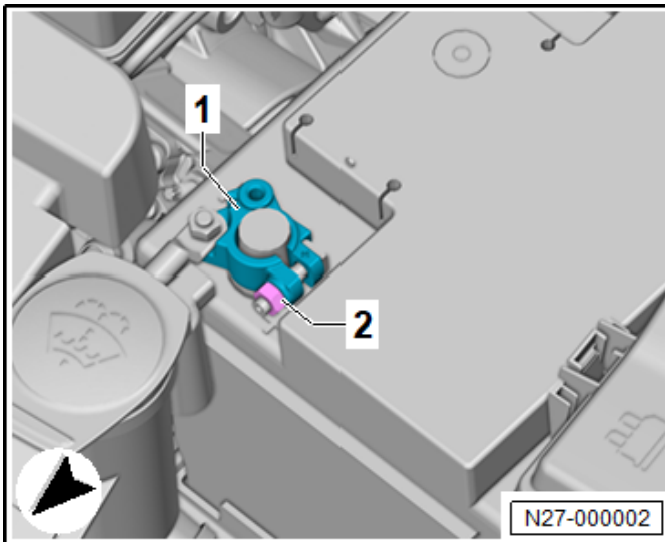

- Loosen the nut <2> several turns and remove the positive terminal battery clamp <1>.

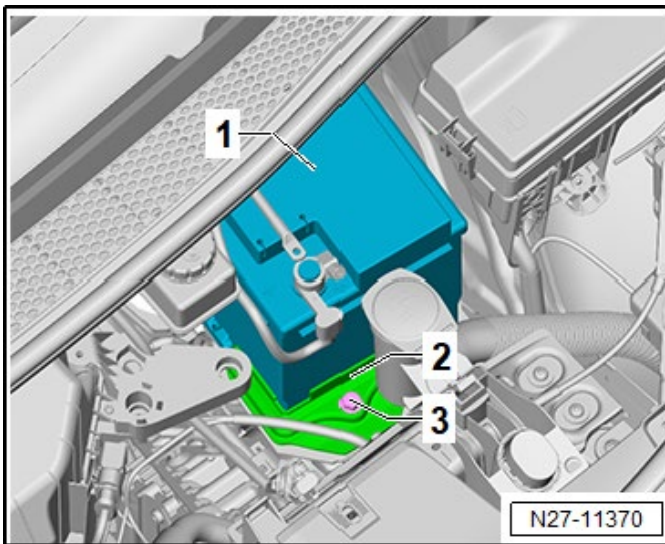

- Remove the bolt <3>.
- Remove the bracket <2>.
- Remove the battery <1> in the direction of travel from the battery tray and lift it upward out of the engine compartment.
- Install the new battery in the reverse order of removal.

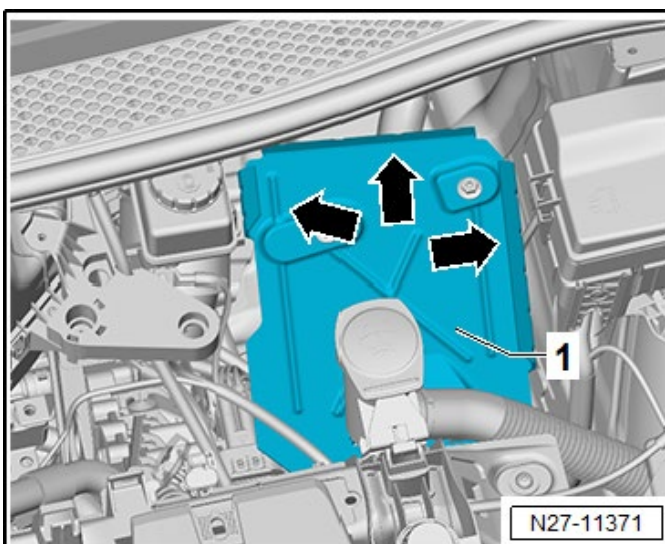

- Insert the battery into the battery tray <1> so that the battery clamping strip touches the rear and side stops <arrows>.

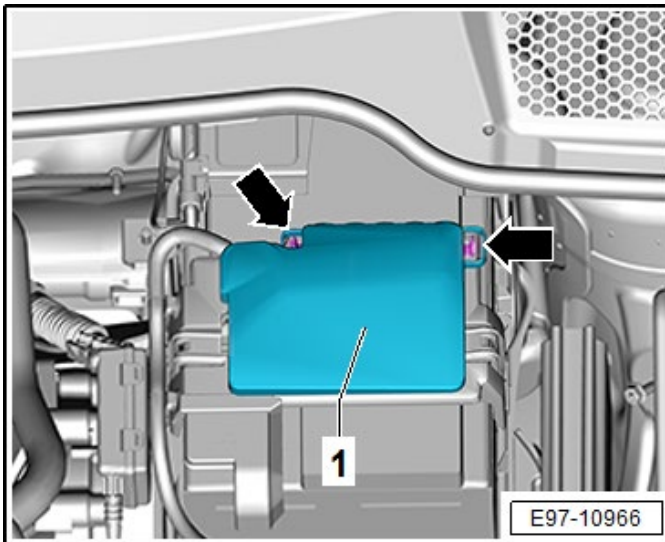

CAUTION

Risk of short circuit
 The battery cable cover <1> must be installed before tightening the battery negative terminal clamp.

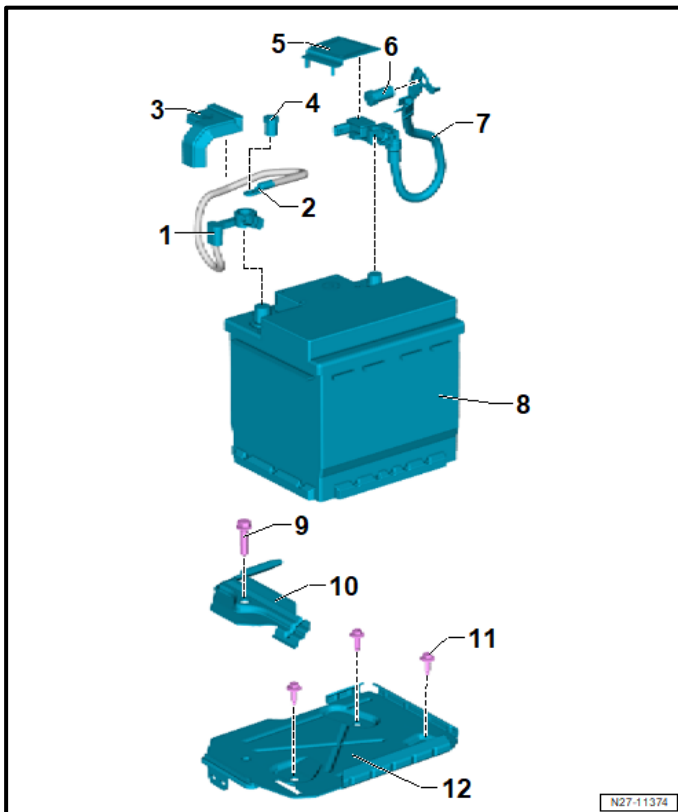

- Torque battery hold-down bolt <9> to 20 Nm.
- Torque battery terminals to 5 Nm.
- Torque power cables on top of battery to 6 Nm.
- Install covers.
- Install impact member and torque bolts to 20 Nm.

TIP

The impact member and covers can also be installed at the very end of the repair. Doing so will make connecting and disconnecting the battery charger easier.

Proceed to Step 3 for performing vehicle software update via SVM.

Step 3 – Perform Software Update SVM

NOTE: this step is required for ALL vehicles

! NOTE

Flashing times will vary. The time it takes to complete the software updates is dependent on several factors, including the workshop's internet download speed.

! NOTE

Only one key can be in the vehicle when performing this software flash.

The vehicle key's battery must be ok.

Any additional keys must be a minimum of 20 meters away from the vehicle.

The car **MUST NOT** be hooked up to a high-voltage charger.

The seat belt must **NOT** be inserted into the buckle.

The driver door must be open.

! NOTE

If a diagnostic session was started before the USB update in Step 1, address 005F and address 8125 must be re-identified before attempting SVM F313

Failure to do so can result in error code ERP0215E when the SVM is attempted.

- Address 005F and address 8125 software versions should = 0561

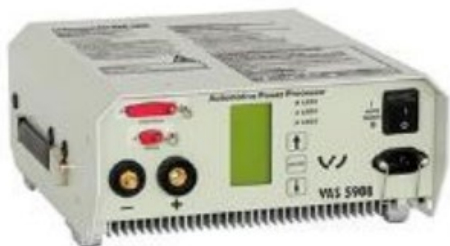

! NOTE

The battery charger may shut off automatically after several hours due to a default setting. Each time the battery charger is reconnected, it must be turned OFF and then back ON to reset the charging start time.

- Turn battery charger OFF, then back ON.
- Connect battery charger.
- **Cycle the ignition OFF, then back ON.**
- Confirm that scan tool is communicating with the diagnostic head by USB <Green Arrow>.
 - If the Bluetooth symbol is shown <Red Arrow> then disconnect the diagnostic head from the vehicle and reconnect the USB cable to the diagnostic head and then reattach to the vehicle.
- Upon ODIS startup, verify the "Diagnosis" operating mode is selected <as shown>.
- Turn the hazards on.

⚠ CRITICAL REPAIR STEP

STOP STOP!

If any of the modules being updated are offline, the communication issue must be addressed prior to starting this software update.

Any module with a “Faulty Control Module” fault *that cannot be cleared*, must be addressed prior to starting the software update. The flash may fail for the affected control module.

Diagnosis and repair of pre-existing conditions are not covered under this action.

See Appendix A for the software change table.

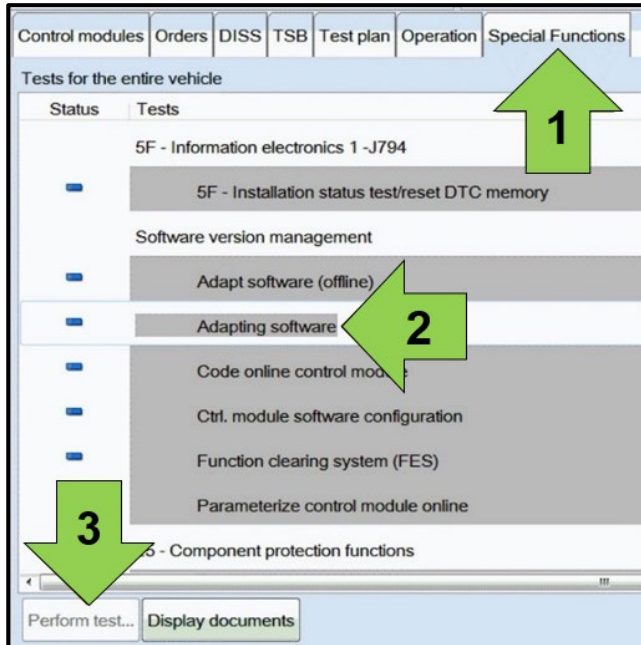

- Once the GFF scan is complete, select “Special functions” <arrow 1>, then “Adapting software” <arrow 2>, then select “Perform test” <arrow 3>.

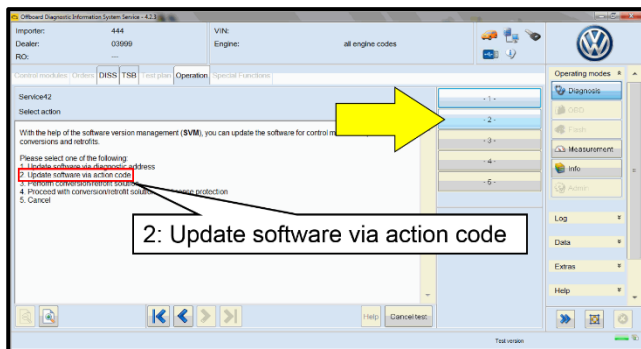

- Select the correct option to “Update software via action code”.

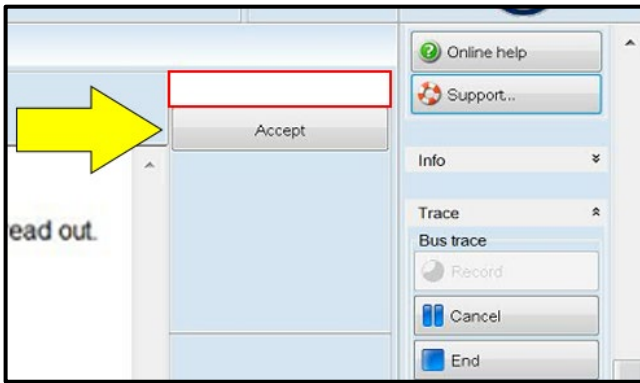

NOTE

Using Bluetooth or WiFi for this action is PROHIBITED!

Damage caused to electronic components during the SVM flash process is not covered.

- Enter the corrective action code (SVM code) as listed below.

SVM code
F313

- Select “Accept” <arrow> and follow the on screen prompts.

NOTE

Do not unplug the sound generator.

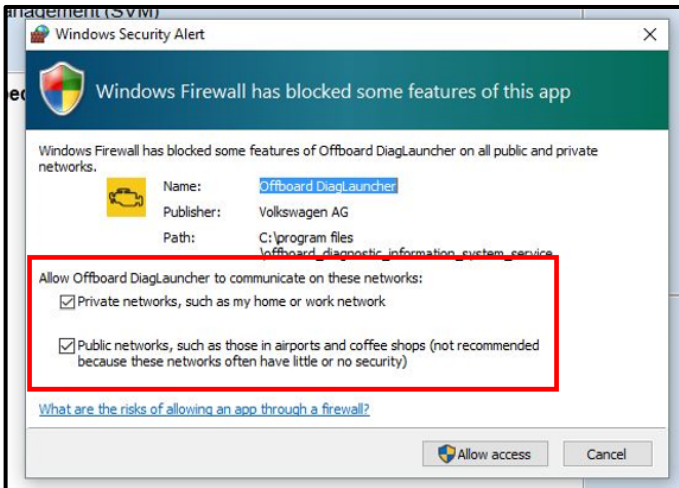

NOTE

When the Windows Firewall popup appears, ALL network options should be checked. Failure to do so could cause the update to fail when first attempting Software Cluster Embedded 1.

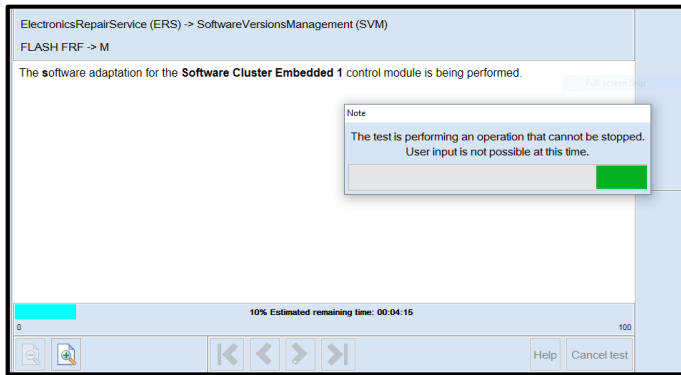

⚠ CRITICAL REPAIR STEP



The initial update may take several minutes to start. Multiple control modules are updated during this procedure. Some modules will take a while to be updated. **DO NOT** cancel the update procedure, turn the ignition off, remove the battery charger, or interrupt the update procedure in any way. Doing so could cause irreparable damage to control units, which is NOT covered under this action.



! NOTE

In-vehicle messages and warnings stating the HV battery state of charge is at 0% may occur during this software update process. This is normal.

! NOTE

If the progress bar for the first update (Software Cluster Embedded 1) stops briefly at 6% (it may also appear that the progress bar stops at 10% briefly, then quickly goes to the end), there may be a firewall issue.

! NOTE

Another indication of a firewall issue is when no modules are updated. The message below will occur, which indicates that the update did not get past DA C002 - Software Cluster Embedded 1. If this occurs, check that all firewall settings are correct. See communication: Diagnostic Device Hardware & Windows®, Number: VHW-22-15 for more information.

Action: Message
 The following control modules have been updated to a recent version number:

- 1: C002 Software Cluster Embedded 1 Flashing **not OK**
- 2: 0019 Data Bus OBD interface Flashing **not OK**
- 3: 0631 Multifunction Steering Wheel Control Module Flashing **not OK**
- 4: 0637 Battery Monitoring Control Module Flashing **not OK**
- 5: 00B7 Interface for access/start system Flashing **not OK**
- 6: 0075 Emergency call module and communication unit Flashing **not OK**
- 7: 0001 Engine electronics Flashing **not OK**
- 8: 0003 Brake Electronics Flashing **not OK**
- 9: 0009 Electronic central electric Flashing **not OK**
- 10: 0023 Brake boost Flashing **not OK**
- 11: 003C Lane change assistance Flashing **not OK**
- 12: 0051 Electric drive Flashing **not OK**

NOTE

If error code ERP0215 occurs:

Cause:

On at least one control unit, the operating conditions for the measure are not fulfilled (for example, incorrect SW part number/HW part number/hardware/software):

Possible Corrections:

Manually identify the affected control module(s), or start a new GFF session and repeat SVM F313.

Perform a bus sleep or reset the control module, then repeat SVM F313.

NOTE

If error code ERP0225E occurs:

Cause:

The measure cannot be carried out because of missing control unit data. Often not all necessary control units are "identified" or "reachable".

Possible Corrections:

Make sure all necessary control units are identified according to the software table. If necessary, manually identify the module and repeat SVM F313.

If a module cannot be manually identified:

- Switch off ignition
- Send diagnostic protocol online
- Disconnect diagnostic interface from vehicle
- Restart ODIS
- Remove the fuse for the module that had the failure for 10 seconds
- Reinstall the fuse
- Perform a bus sleep
- Start a NEW GFF session
- Identify the module
- Repeat SVM F313

NOTE

If a message appears stating that the communication path cannot be changed to DoIP:

- Send the diagnostic protocol online
- Cancel the test plan
- Turn the ignition OFF
- Disconnect the diagnostic head from the vehicle AND the diagnostic tester for a few minutes
- Restart ODIS
- Reconnect diagnostic head to vehicle and diagnostic tester
- Repeat SVM F313

NOTE

If errors occurs and the information provided in these instructions do not resolve the concern, please create a TAC WEB ticket for further direction.

NOTE

Diagnostic address 0631 and 060E may appear to not be reporting and DTC memory cannot be read:

ODIS may display a “?” and not read any DTC memory for DA 0631 and 060E. Modules 0631 & 060E may also not show in the GFF log. These are slave modules. The fault memory cannot be read directly from the module. If the 97ZZ completes successfully and there are not any malfunctions/warnings present, this can be ignored.

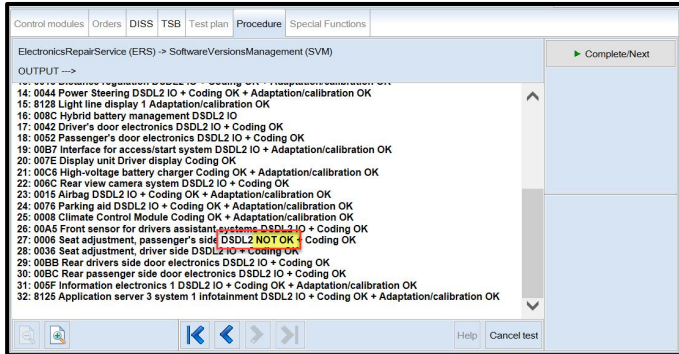

- Pay attention to the status report of the control module updates.
- Any module stating NOT OK will have to be updated again.
- Selecting “Complete/Next” will begin another attempt to update the control module.
- It may take more than one attempt to update every control module.

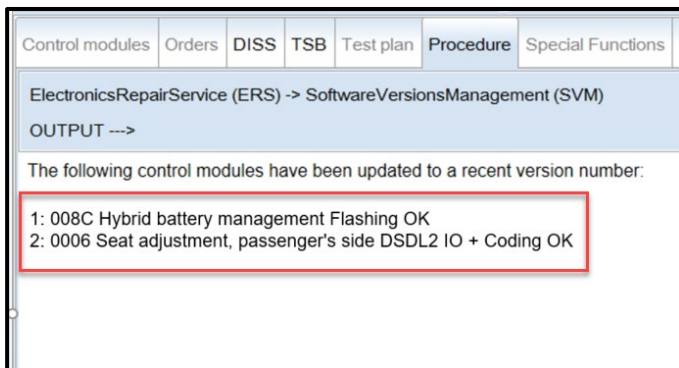

NOTE

If SVM F313 is repeated for any reason, address 008C and 0006 will be updated again. This is normal.

- Do not end the diagnostic session
- **DO NOT proceed to the next SVM update until SVM F313 has 100% completed successfully.**

Proceed to Step 4 for performing vehicle bus sleep.

Step 4 – Perform Bus Sleep Procedure

NOTE: this step is required for ALL vehicles

- Carry out the following steps in the specified sequence to put the vehicle in a bus sleep.
- Switch off the ignition.
- Turn off the hazards.
- Remove diagnosis interface from the vehicle diagnosis connection.
- Remove battery charger from the 12V battery.
- Close front and rear lid as well as all doors.
- Lock vehicle.
- Move vehicle key (remote control) at least 20 meters away from the vehicle.
- Wait at least 15 minutes until the vehicle is in bus silence.
- Then unlock vehicle again.
- Connect and switch on battery charger.
- Insert diagnosis interface on vehicle diagnosis connection.
- Switch on the ignition.
- Place a vehicle key (remote control) in the center console on the reader coil.

Proceed to Step 5 for performing software configuration via SVM.

Step 5 – Perform Software Configuration via SVM

NOTE: this step is required for ALL vehicles

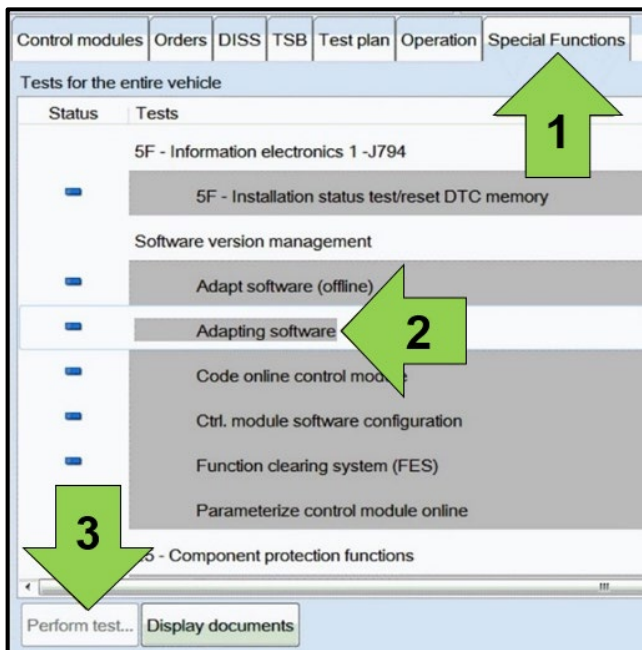

NOTE

The battery charger may shut off automatically after several hours due to a default setting. Each time the battery charger is reconnected, it must be turned OFF and then back ON to reset the charging start time.

- Turn battery charger OFF, then back ON.
- Connect battery charger.
- Turn the hazards on.
- Confirm that scan tool is communicating with the diagnostic head by USB <Green Arrow>.
 - If the Bluetooth symbol is shown <Red Arrow> then disconnect the diagnostic head from the vehicle and reconnect the USB cable to the diagnostic head and then reattach to the vehicle.
- Upon ODIS startup, verify the “Diagnosis” operating mode is selected <as shown>.
- Once the GFF scan is complete, select “Special functions” <arrow 1>, then “Adapting software” <arrow 2>, then select “Perform test” <arrow 3>.

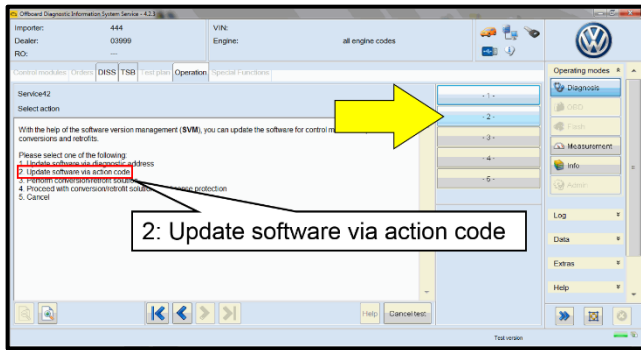

- Select the correct option to “Update software via action code”.

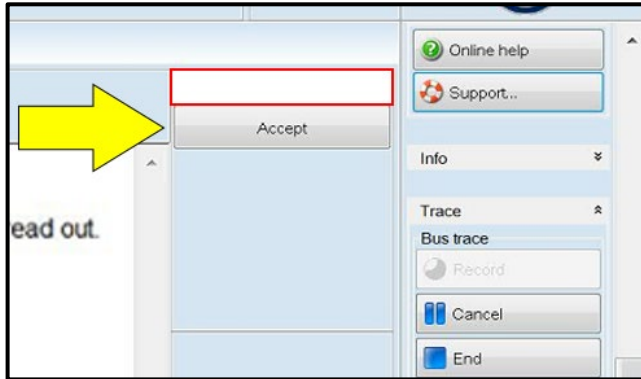

NOTE

Using Bluetooth or WiFi for this action is PROHIBITED!

Damage caused to electronic components (e.g. ECM, TCM, etc.) during the SVM flash process is not covered.

- Enter the corrective action code (SVM code) as listed below.

SVM code
S313

- Select “Accept” <arrow> and follow the on screen prompts.
- Pay attention to the status report of the control module updates.
- Any module stating NOT OK will have to be updated again.
- Selecting “Complete/Next” will begin another attempt to update the control module.
- Do not end the diagnostic session.

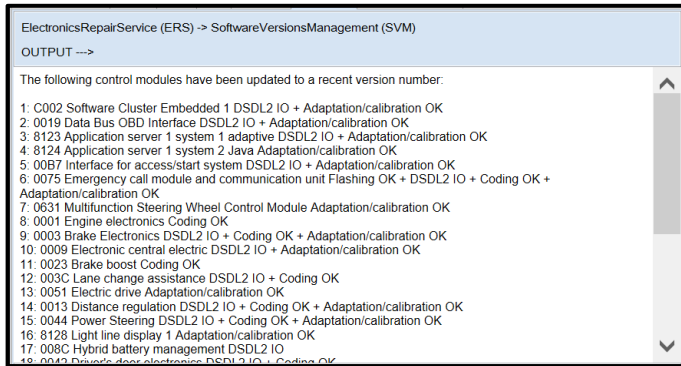

Proceed to Step 6 for performing Replace 12V Battery test plan via GFF

Step 6 – Perform Replace 12V Battery Test Plan

NOTE: this step is required only for vehicles assigned Criteria 01

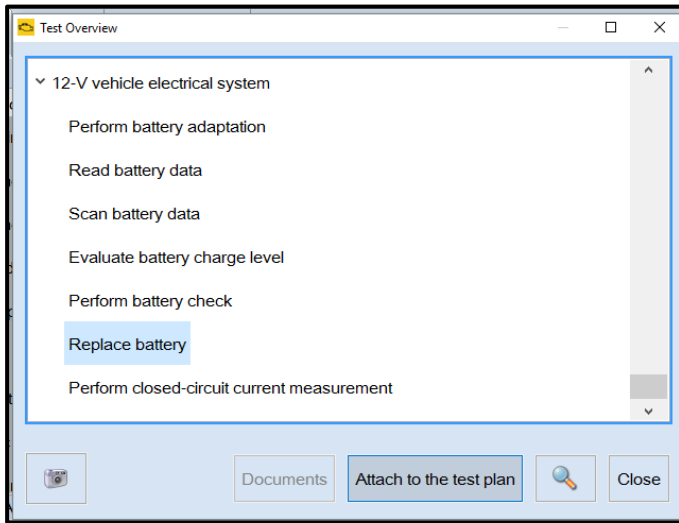

- Perform “**Replace battery**” test plan.
- Follow the on-screen prompts.
- Pay close attention to all steps outlined in the test plan and follow them exactly as described.
- Do not end the diagnostic session.

Proceed to Step 7 for performing Bus Sleep Procedure

Step 7 – Perform Bus Sleep Procedure

NOTE: this step is required for ALL vehicles

- Carry out the following steps in the specified sequence to put the vehicle in a bus sleep.
- Switch off the ignition.
- Turn off the hazards.
- Remove diagnosis interface from the vehicle diagnosis connection.
- Remove battery charger from the 12V battery.
- Close front and rear lid as well as all doors.
- Lock vehicle.
- Move vehicle key (remote control) at least 20 meters away from the vehicle.
- Wait at least 15 minutes until the vehicle is in bus silence.
- Then unlock vehicle again.
- Connect and switch on battery charger.
- Insert diagnosis interface on vehicle diagnosis connection.
- Switch on the ignition.
- Place a vehicle key (remote control) in the center console on the reader coil.

Proceed to Step 8 for performing Learn VKMS Test Plan via GFF

Step 8 – Perform VKMS Adaptation Test Plan

NOTE: this step is required for ALL vehicles

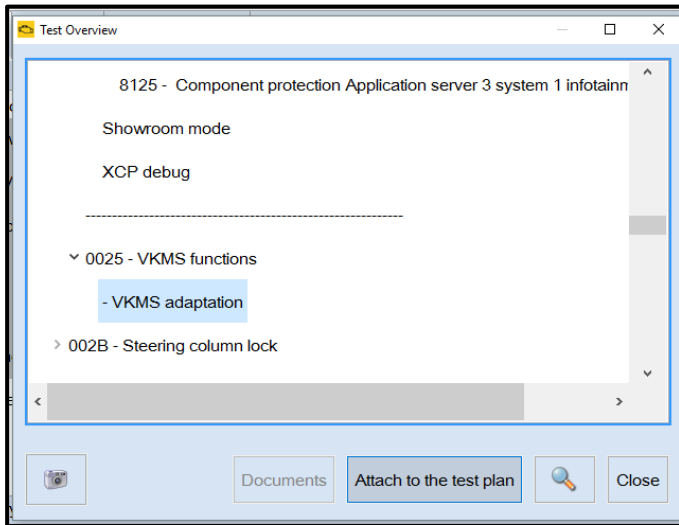

- Perform 0025 Immobilizer “VKMS Adaptation” test plan.

TIP

After selecting “Self Test,” use the search function and enter “VKMS” to aid in finding the test plan.

- Follow the on-screen prompts.
- Pay close attention to all steps outlined in the test plan and follow them exactly as described.
- Do not end the diagnostic session.

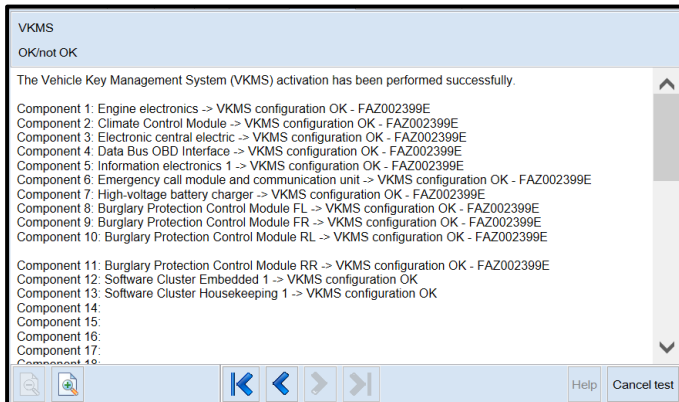

- Ensure each component shows the VKMS configuration is OK.
- If any component does not complete the VKMS adaptation, repeat the test plan.

Proceed to Step 9 for performing manual basic settings

Step 9 – Perform Manual Basic Settings and Adjust Temperature Setting (if necessary)

NOTE: this step is required for ALL vehicles

With the software update the basic settings of the steering angle sender -G85- and the end stops (soft stop) of the electric window lifter are lost.

- Perform manual basic settings of steering angle sender -G85-:
 - Create drive readiness.
 - Turn steering wheel completely to the left and hold in the end position for 3 seconds.
 - Turn steering wheel completely to the right and hold in the end position for 3 seconds.
 - Return steering wheel to straight-ahead position.
 - Yellow steering light in cluster should go out.
- Adapt end stops (soft stop) of the electric window lifter for all windows:
 - Lower window completely. Release the switch. Hold window switch in the down position, at the second detent for 3 seconds.
 - Raise window completely. Release the switch. Hold window switch in the up position, at the second detent for 3 seconds.
- This software update may change the temperature units from Fahrenheit to Celsius. The setting can be changed in the infotainment display by going to *Settings > Unit Settings*. This setting should be adjusted based on customer preference.



Proceed to Step 10 for Adjusting Service Interval

Step 10 – Adjusting Service Interval

NOTE: this step is required for ALL vehicles

NOTE

- The service interval display may be reset by the software configuration. The current service interval should have been read out at the beginning of this repair.
- It is also possible that the service interval could have been reset on a previous service visit if a software configuration was carried out on the vehicle. Therefore, the service interval should be compared to the vehicle's service records. If there is a discrepancy, the service interval values will have to be adjusted accordingly.
- After the software updates are complete, the adaptation channels will also change:
 - Pre-flash:
 - \$0541 (distance driven since the last inspection AND time since the last inspection)
 - Post-flash:
 - \$0548 (distance driven since the last inspection)
 - \$0549 (time since the last inspection)

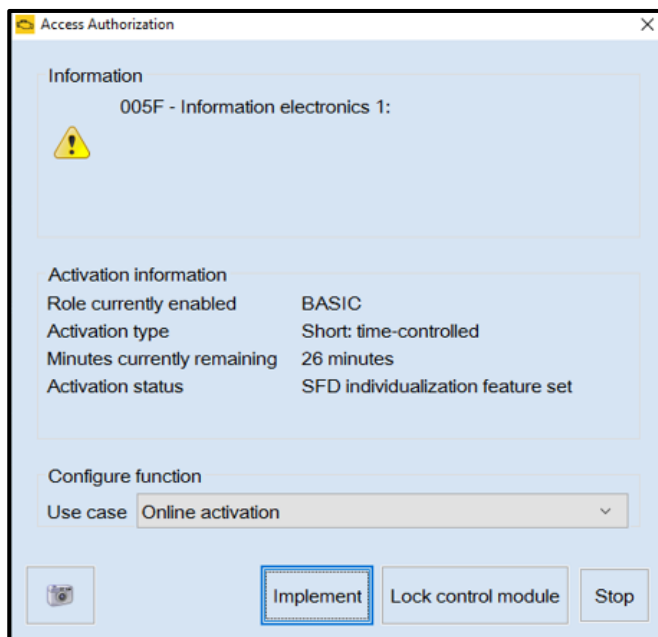

- From the OBD menu, go to: OBD > DA 005F > *Access authorization*.
- Select “Implement” and then enter ODIS login/password if prompted (to unlock SFD).
- Select “stop” to close the window.

- Using Operating mode “OBD”, check 005F adaptation channels \$0548 and \$0549 for the current service interval settings (OBD > DA 005F > *Adaptations*).
- If the values are the same as the previously recorded values, no change is necessary.
- If the values have changed, enter the correct values as needed.

Adaptation/parameter	RDID	Current value	Input	Unit
[LO]_FIX_Maximum_time_to_next_time_based_service_event		365		d
▼ Inspection, distance driven since the last inspection	\$0548			
[LO]_FIX_Set_mileage_since_last_mileage_based_service_event		12,500		km
▼ Inspection, time since the last inspection	\$0549			
[LO]_FIX_Set_time_since_last_time_based_service_event		325		d

Filter: inspect

Buttons: Accept, Restore, Reset all, +, -

005F - ANP

TIP: Enter “inspect” in the Filter field <arrow> and both adaptation channels will be shown.

Proceed to Step 11 for performing GFF test plans for faults created by the flash process

Step 11 – Perform GFF Test Plans For All Faults Created by the Flash Process

NOTE: this step is required for ALL vehicles

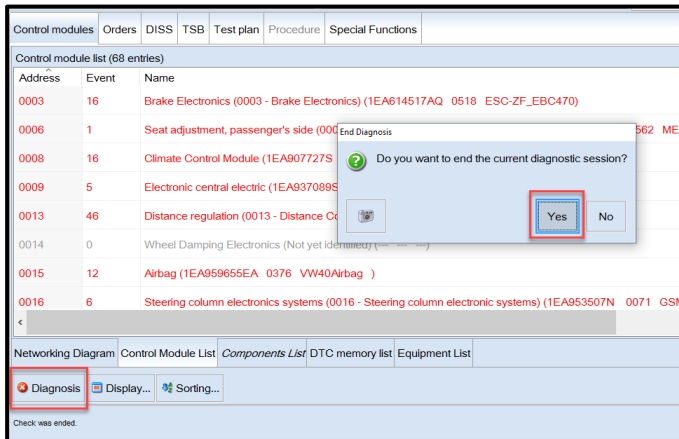

- Exit Diagnosis and select “Yes” to end the diagnostic session.

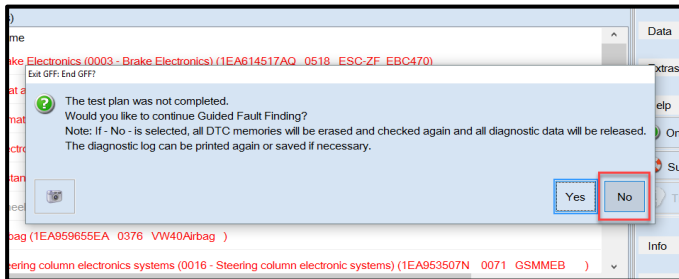

- When prompted to continue Guided Fault Finding, select “NO”.
- GFF will be exited and faults will be erased.

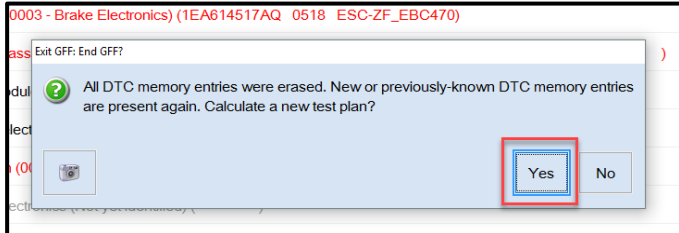

- Static faults created by the flash process will remain.
- When prompted, select “YES” to populate new test plans.

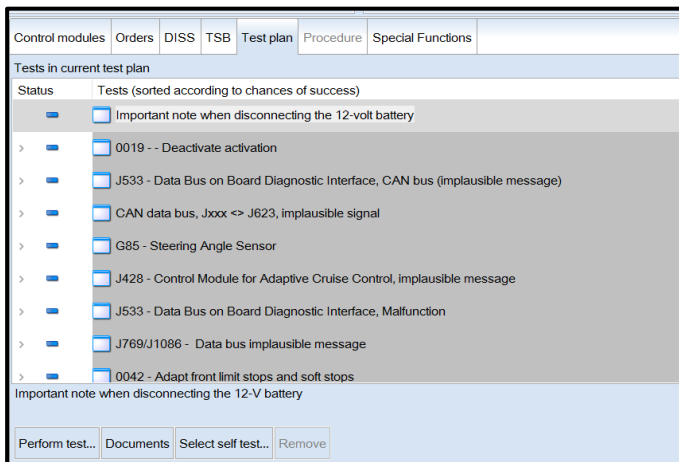

- Work through all test plans for faults created by the flash process.
- Reference any applicable TSBs that address “ghost” faults.
- Pay close attention to all steps outlined in the test plans and follow them exactly as described.
- Exit GFF and send diagnostic protocol online.

NOTE

Driver assist systems will not require re-calibration due to this software update.

NOTE

At the end of the diagnosis, the diagnostic tester requires the calibration of the three-phase drive -VX54-.

The calibration does not have to be performed at the end of the diagnosis; it can be carried out without the diagnosis tester on a test drive above 20 mph/ 35 kph (before returning the vehicle to the customer).

NOTE

Static faults may store in various control modules during the flash.

The ID Light may not operate as designed after the flash.

It may be necessary to perform the following in order to clear the faults and restore the ID Light operation:

- Drive the vehicle a short distance (around the parking lot, for example).
- Perform a bus sleep.

Proceed to Step 12 for providing the owner’s manual kit.

Step 12 – Provide the Owner’s Manual Kit

NOTE: this step can be performed while the software update is in progress

NOTE: this step is required only for vehicles assigned additional Criteria 03, 04 or 05

! NOTE

Dealers were sent an initial allocation prior to customer notification.

The allocation included a delivery of owner’s manuals and a separate delivery of tow hook supplements.



Replace the owner’s manual and provide a tow hook supplement.

- On the first page (inside) of the owner's manual enclosed in the vehicle there is the vehicle data sticker and information on PDI and date of delivery/registration.
- To ensure this information is not lost to the customer, cut out the first page of the owner's manual with a sharp knife, as shown in the illustration <red dotted line>.
- We recommend the use of a steel ruler or another suitable implement to guide the knife and ensure a straight cutting line.
- Include the cut-out page in the new owner’s manual.

Criteria	Description
03	US English Kit (US English owner’s manual + English tow hook supplement)
04	CAN English Kit (CAN English owner’s manual + English tow hook supplement)
05	CAN French Kit (CAN French owner’s manual + French tow hook supplement)

! NOTE

Canadian dealers must provide one of these documents in the language of the customer's choice.

Proceed to Step 13 for printing out additional owner’s manual supplement.

Step 13 – Print and Provide Additional Owner’s Manual Supplement

NOTE: this step can be performed while the software update is in progress

NOTE: this step is required only for ALL vehicles



Technical modifications
ID.3, ID.4, ID.5

This supplement describes revisions that have been produced after publication of the “ID.3, ID.4, ID.5” Owner’s Manual. The new section replaces the corresponding sections “Driving” and “Exiting a vehicle while the vehicle’s drive system is active” as well as “Parking and maneuvering”, “Electronic parking brake” and “Automatic switch-on if you leave the vehicle incorrectly” of the Owner’s Manual editions up to 2022/06.

Please refer to the other sections of the Owner’s Manual for all other information, descriptions, and specifications for the operation and handling of your vehicle, such as information you should know regarding your personal safety and the safety of your passengers.



Modifications techniques
ID.3, ID.4, ID.5

Le présent Supplément décrit les modifications apportées après la publication du Manuel du Propriétaire de l’« ID.3, l’ID.4 et l’ID.5 ». La nouvelle section remplace la section correspondante dans les chapitres « Conduite » et « Quitter le véhicule avec disponibilité de marche activée », ainsi que « Stationnement et manoeuvres », « Frein de stationnement électronique » et « Activation automatique lorsque vous quittez le véhicule de manière incorrecte » dans les versions jusqu’à 06/2022 du Manuel du Propriétaire.

Pour toute autre remarque, description ou indication concernant le fonctionnement et l’utilisation de votre véhicule ainsi que pour toute information relative à votre propre sécurité et à celle de vos passagers, veuillez consulter les autres chapitres de votre Livre de Bord.

Replace the owner’s manual and provide a tow hook supplement.

- U.S.A.: Print out the English owner’s manual supplement found on one of the ELSA attachment tabs or in ServiceNet.
- CANADA: Print out the English and French owner’s manual supplements found on one of the ELSA attachment tabs or in ServiceNet.
- When printing, select “Booklet” for page sizing.
- Place the printed owner’s manual supplement in the vehicle glove compartment.

Proceed to Section C

Section C – Campaign Completion Label

Install Campaign Completion Label

- Fill out and affix Campaign Completion Label, part number CAMP 010 000, next to the vehicle emission control information label.

TIP

Ensure Campaign Completion Label does not cover any existing label(s).

Proceed to section D

Section D - Parts Return/Disposal

Properly store (retain), destroy or dispose of removed parts” in accordance with all state/province and local requirements, unless otherwise indicated and/or requested through the Warranty Parts Portal (WPP) for U.S. and the Part Destruction and Core Disposition Report for Canada.

NOTE

Batteries have 15 month threshold to be used in vehicles. Please make sure you are using batteries “first-in-first-out” (FIFO) order, reducing the risk of obsolescence.

Interstate standard return process regarding expiration dates are to be used for this action.

Appendix A – Software Table

Diagnostic Address	New Part Number	New Software Version
C002	V04007003HM	0290
0019	1EA937012N	0292
0631	1EA959442H	0032
0637	1EA915181	1074
	1EA915181B	1074
00B7	5WA959436H	0725
	5WA959436J	0725
0075	11A035285C	0664
0001	0EA906012CP	2222
0003	1EA614517AQ	0518
0009	1EA937084B	0307
	1EA937086G	0307
	1EA937089S	0307
	1EA937089T	0307
	1EA937089Q	0307
0023	1EA909059AM	0625
003C	2Q0907686G	0287
0051	1EA907121BC	6045
0013	1EA907572H	0234
0044	1EA907144AQ	5033
060E	10A919606D	6085
	10A919606F	6085
	10A919606K	6085
	10A919606L	6085
	10A919606M	6085
	10A919606P	6085
	10A919606R	6085
	10A919606S	6085
	10A919605K	3080
	10A919605H	3080
	10A919605H	2103
	10A919605K	2103
	10A919605L	2103
	10A919605M	2103
	10A919605P	2103
8128	11B919451C	0107
06D1	OZ1915140F	1000
06D5	OZ1915140F	1000
06D9	OZ1915140F	1000
06F1	OZ1915140F	1000
008C	OZ1915184J	1041

The information in this document is intended for use only by skilled technicians who have the proper tools, equipment and training to correctly and safely maintain your vehicle. These procedures are not intended to be attempted by "do-it-yourselfers," and you should not assume this document applies to your vehicle, or that your vehicle has the condition described. To determine whether this information applies, contact an authorized Volkswagen dealer. ©2023 Volkswagen Group of America, Inc. and Volkswagen Canada. All Rights Reserved.

Diagnostic Address	New Part Number	New Software Version
0042	1EA959593B	0550
0052	1EA959592B	0550
007E	10A920320C	0531
00C6	1EA915684DB	1019
	1EA915684DJ	1019
	1EA915684EK	1019
	1EA915684DQ	1019
006C	1EA980556F	0394
0015	1EA959655EA	0376
8105	1EA907190G	1142
0076	1EA919294D	0421
0008	1EA907727S	0425
	1EA907727T	0425
00A5	1EA980654K	5321
	1EA980653C	5321
0006	1EB959760H	0562
00BB	1EA959597B	0550
00BC	1EA959596B	0550
00CE	1ED907121AB	8351
005F	10A035842J	0561
8125	V04007003GH	0561
0036	1EB959760H	0562

The information in this document is intended for use only by skilled technicians who have the proper tools, equipment and training to correctly and safely maintain your vehicle. These procedures are not intended to be attempted by "do-it-yourselfers," and you should not assume this document applies to your vehicle, or that your vehicle has the condition described. To determine whether this information applies, contact an authorized Volkswagen dealer. ©2023 Volkswagen Group of America, Inc. and Volkswagen Canada. All Rights Reserved.