



FIELD KIT

Vermeer MV Solutions, Inc.

Trenchless
Piedmont, South Carolina 29673 USA

FIELD CAMPAIGN KIT #: VMV000056 **DATE:** 7 March 2023
For Dealer Reference: Service Bulletin #: SMV2023-013

Rear Impact Guard and Lighting Kit

CAMPAIGN TYPE:	Mandatory - Product Compliance DEALER INSTALLATION ONLY
CAMPAIGN CATEGORY:	Kit and Bulletin

MACHINE/ ATTACHMENT MODEL(S):	SERIAL NUMBERS:		Kit version
	Included	Excluded	
VX75	See attached listing on page 7 of this kit for specific Vacuum VIN and trailer VIN.	N/A	VMV01
V800			
VX80			



Purpose: This kit includes parts and instructions to develop and produce kits that will include necessary parts to achieve compliance with S5, FMVSS 108 and 224, while maintaining compliance with S5, FMVSS 223.

Special tools and conditions:

- N/A



WARNING: Use the following shutdown procedure before attempting to do any of the work described in this kit.

STOPPING THE MACHINE

NOTICE: For your safety and the safety of others, use the shutdown procedure before servicing, cleaning, unclogging or inspecting the machine.

A variation of this procedure may be used if instructed within this manual, or if an emergency requires it.

Step 1: Reduce engine speed to idle.

Step 2: Verify all switches are in off/down position.

Step 3: Move reverse flow control to neutral.

Step 4: Allow engine to idle for five minutes before turning it off after full-load operation.

NOTICE: Failure to allow engine to idle for the recommended time may result in turbocharger damage.

1. Remove lower hose storage bracket assembly:
 - A. 1x HOSE CONTAINER WELDMT (BOTTOM).
 - B. 1x GASKET INLET/OUTLET DOOR LE (8046191). **Keep for re-use**
 - C. Mounting hardware for hose storage bracket.

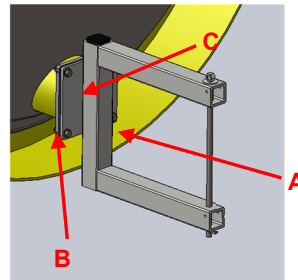

Step 1

2. Remove and disconnect lighting:
 - D. 2x Stop/Turn Lights and Gasket (8095893-35). **Keep for re-use.**
 - E. 4x Red Running Lights and Gaskets (8095893-34).
 - F. 1x License plate holder and hardware (8095893-36)
 - G. 1x License plate and hardware, if present. **Keep for re-use.**

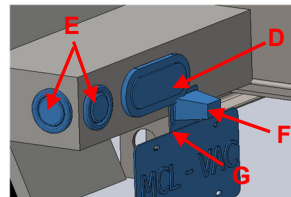

Step 2

- 3. Mark and drill holes in fenders on both sides for re-routing of wiring, Mag-drill recommended.
 - H. Mark hole in location shown.
 - I. Drill 2x Ø1.13 holes on rear sides of fenders.

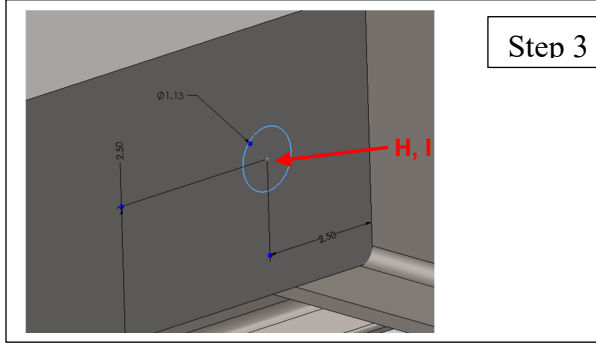

- 4. Install drain cover plate as shown:
 - J. Step 4 Parts:
 - a. 1x GASKET CVR, OUTLET DOOR XCEL (8090720). Included with kit.
 - b. 1x GASKET INLET/OUTLET DOOR LE (8046191). Reused from step 1.
 - c. 4x SCREW, HC .375-16 X 1.5, YZ, G8 (U000465). Included with kit.
 - d. 4x NUT, LOCK .375-16 NY YZ G8 (U120114). Included with kit.
 - e. 8x WASHER FLAT .375 SAE THRU HARD (U20085). Included with kit.
 - K. Install new cover plate as shown.
 - L. Torque bolts to Vermeer Standard Torque for 3/8" – 16 NC Grade 8 with Nylock Nuts: 33 ft-lbs

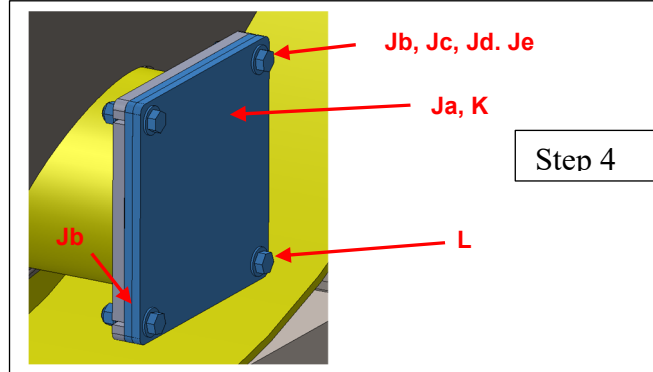

- 5. Mark and drill holes in main trailer rail for installation of rear-guard structure, Mag-drill recommended:
 - M. Remove conspicuity tape and fix paint if conflicting with hole locations.
 - N. 12x Ø0.6875 holes at locations shown in image.

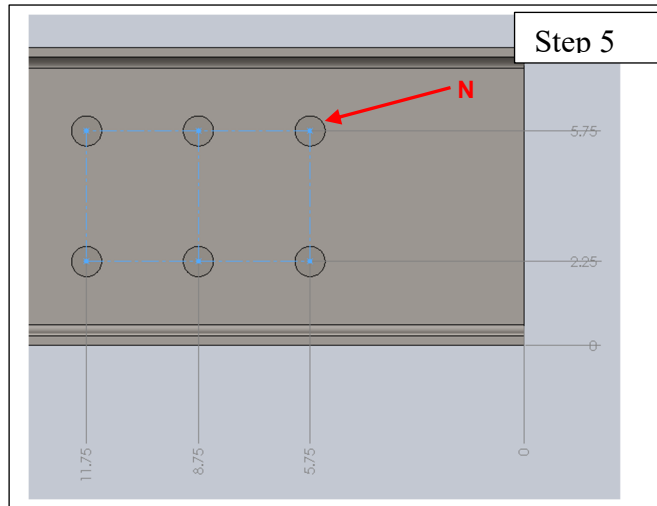

6. Install rear guard structure by sliding mounting frames into rails and bolting in place, using shims as appropriate for gaps.

O. Step 6 parts:

- a. 1x WELDMENT, REAR GUARD (135007297). Included with kit.
- b. 12x SCREW, HC .625-11X4.00 ZP G8 (U001321). Included with kit.
- c. 12x NUT, LOCK, NY, .625-11 ZP G8 (U120025). Included with kit.
- d. 24x WASHER FLAT .625 ZP SAE HARD (U200150). Included with kit.

P. Torque bolts to Vermeer Standard Torque for 5/8" – 11 NC Grade 8 with Nylock Nuts: 159 ft-lbs

7. Mark and drill holes in trailer to mount chute as shown, Mag-drill recommended:

Q. 4x Ø0.4375 holes at locations shown in images

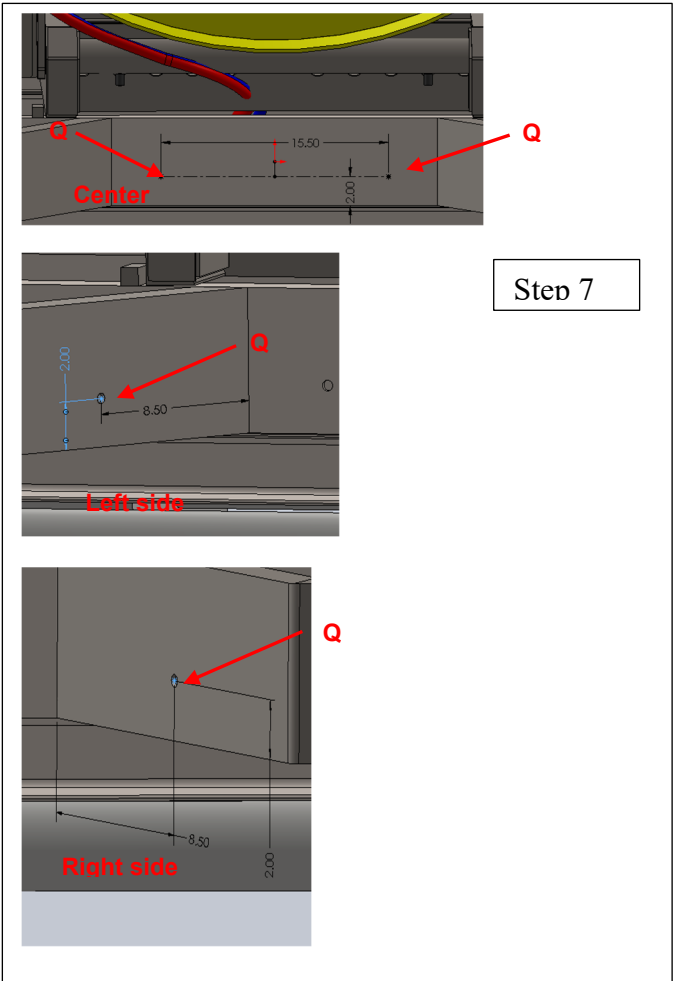
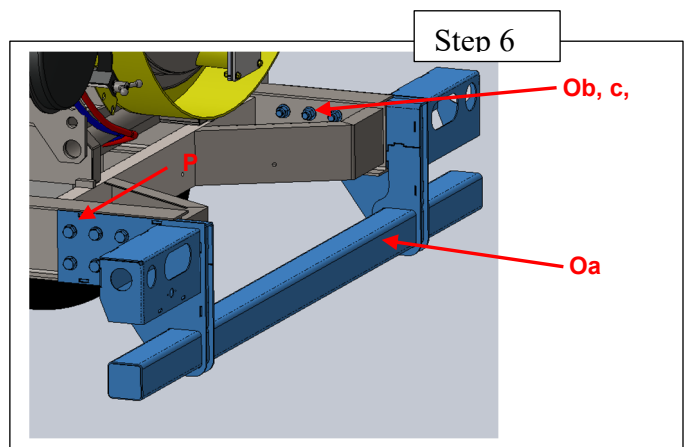

8. Install chute as shown

R. Step 8 Parts:

- a. 1x CHUTE, XCEL 75 UNDERRUN KIT (135007414). Included with kit.
- b. 4x SCREW, HC .375-16 X 1.5, YZ, G8 (U000465). Included with kit.
- c. 4x NUT, LOCK .375-16 NY YZ G8 (U120114). Included with kit.
- d. 8x WASHER FLAT .375 SAE THRU HARD (U20085). Included with kit.

S. Torque bolts to Vermeer Standard Torque for 3/8" – 16 NC Grade 8 with Nylock Nuts: 33 ft-lbs

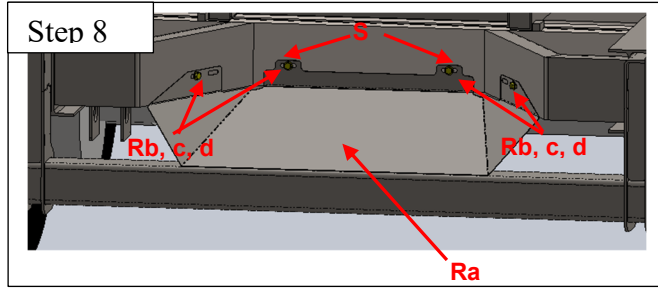

9. Install lighting on rear guard, as shown.

T. Step 9 Parts:

- a. 2x Stop/Turn Lights and Grommets (8095893-35). Re-use from step 2.
- b. 4x Red Running Lights (135000528) and Grommets (135000529). Included with kit.
- c. 1x LIGHT, DIRECTIONAL LED, LICENSE PLATE (8097874). Included with kit.
- d. 2x SCREW, PAN HD PHIL #8-32 X .75 (U030802). Included with kit.
- e. 2x WASHER FLAT #8 ZP (U030801). Included with kit.
- f. 2x NUT, NY #8-32 (U030800). Included with kit.

U. Insert retention grommets and lights into light boxes on rear guard.

V. Use #8 Hardware to install license plate light.

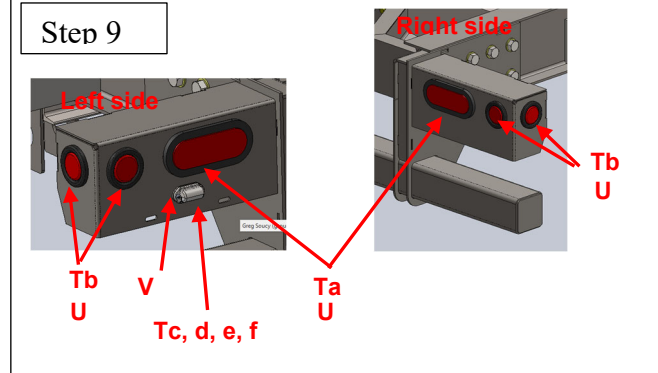

10. Install conspicuity tape on rear guard as shown:

W. Use conspicuity tape (8041236). Included with kit.

X. Maximize coverage on horizontal surfaces of vacuum.

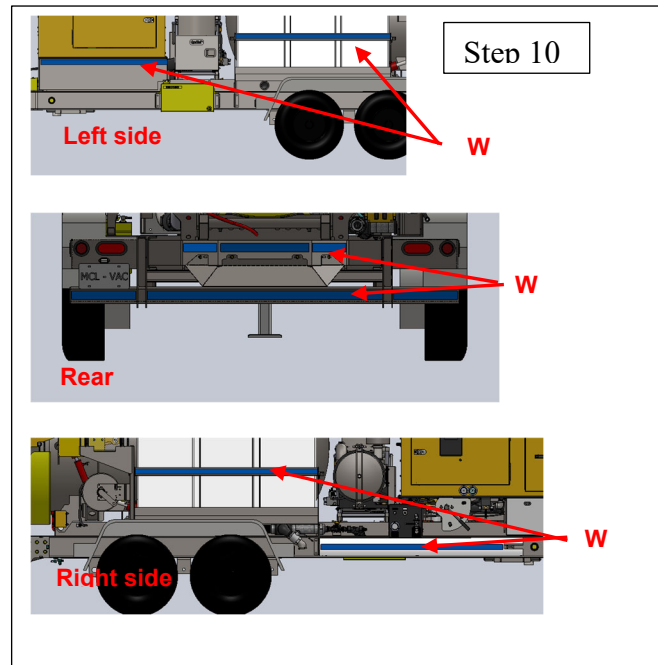

11. Reconnect wiring between lighting on rear guard and trailer:

Y. Step 11 parts:

- a. 1x WIRING KIT, LIGHT RELOCATION, VX75 XCEL (135007540). Included with kit.
- b. 2x P-CLAMP, 3/8" ID, 3/8" BOLT (135002707). Included with kit.
- c. 4x WASHER, FLAT 1/4 ZP (U200020). Included with kit.
- d. 2x NUT, LOCK, NY, .250-20 ZP G2 (U120000). Included with kit.
- e. 2x SCREW, PAN HD PHIL 1/4-20 X 1" (U030851). Included with kit.

Z. Install p-clamp and grommets as shown (grommets included in wiring kit).

AA. Cut wiring to necessary length and create extensions using included connectors.

BB. Prior to butt-connector, cut existing harness and add connectors to add extension.

CC. Route wiring through p-clamp and grommets to relocated lighting.

12. Reinstall license plate using removed hardware if removed during step 2.

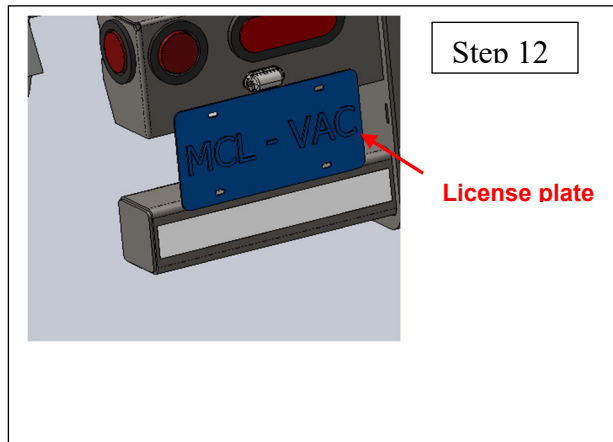
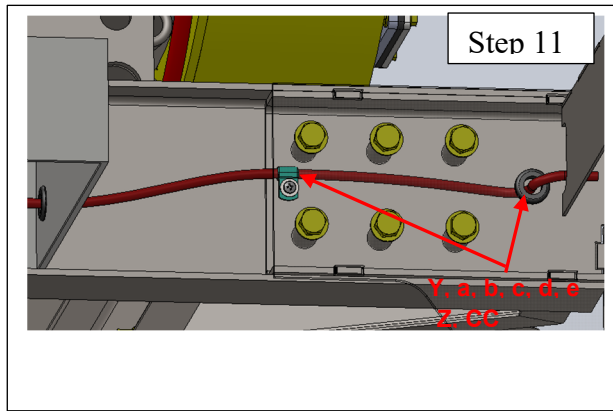

AFFECTED MACHINES - VMV010056

VACUUM MODEL	VIN	TRAILER VIN
V800		
V800		
V800		
V800		
V800		
V800		
V800		
VX75		
VX75		
VX75		
VX75		
VX75		
VX75		
VX75		
VX75		
VX75		
VX75		
VX75		
VX75		
VX75		
VX75		
VX75		
VX75		
VX75		
VX75		
VX80		
VX80		
VX80		
VX80		
VX80		
VX80		
VX80		
VX80		
VX80		
VX80		



WARNING: Pressurized fluid can penetrate body tissue and result in death or serious injury. Leaks can be invisible. Keep away from any suspected leak. Relieve pressure in the hydraulic system before searching for leaks, disconnecting hoses, or performing any other work on the system. If you must pressurize the system to find a suspected leak, use an object such as a piece of wood or cardboard rather than your hands. When loosening a fitting where some residual pressure may exist, slowly loosen the fitting until oil begins to leak. Wait for leaking to stop before disconnecting the fitting. Fluid injected under the skin must be removed immediately by a surgeon familiar with this type of injury.

Figure 1

UNIT OWNER COPY:
Insert in parts manual
for future reference.

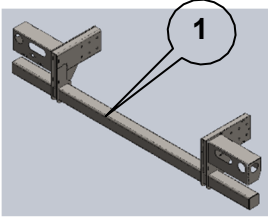

135007297

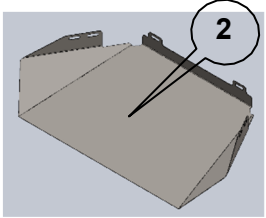

135007414

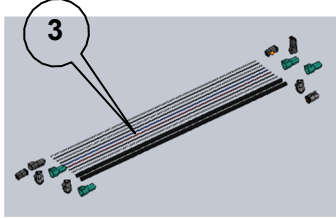

135007540

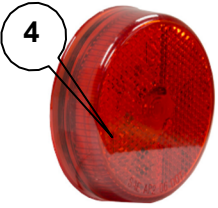

135000528



135000529

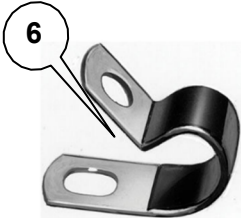

135002707

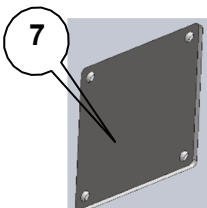

8090720

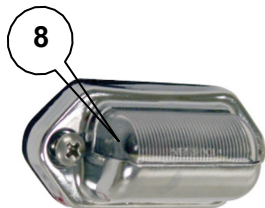

8097874

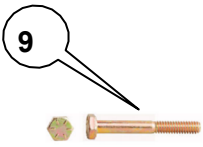

U001321

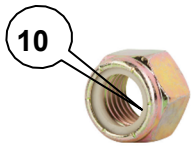

U120025

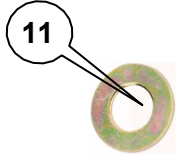

U200150

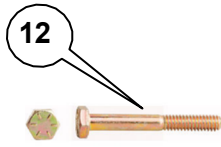

U000465



U030800

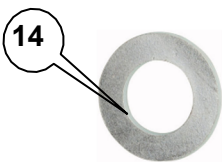

U030801

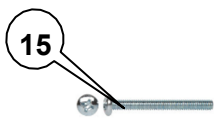

U030802

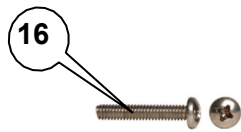

U030851

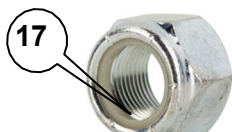

U120000

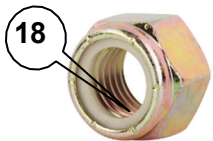

U120114

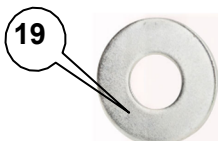

U200020

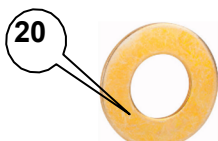

U200085

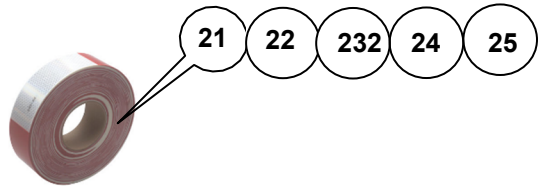

- 8041236-.015.00
- 8041236-.016.00
- 8041236-.021.00
- 8041236-.055.00
- 8041236-.067.00

Figure 1 parts list

<u>REF. NO.</u>	<u>PART NO.</u>	<u>DESCRIPTION</u>	<u>IK01 QTY.</u>
1	135007297	Weldment, rear guard	1
2	135007414	Chute, XCEL 75 underrun kit	1
3	135007540	Wiring kit, light relocation, VX75 XCEL	1
4	135000528	Red marker light	4
5	135000529	Grommet	4
6	135002707	3/8 med duty .406 hole diameter vinyl cushion tube clam	2
7	8090720	Gasket cvr, outlet door XCEL mods N900040	1
8	8097874	Light, directional LED license plate	1
9	U001321	Screw, HC .625-11x4.00 ZP G8	12
10	U120025	Nut, lock, NY, .625-11 ZP G8	12
11	U200150	Washer flat .625 ZP SAE hard	24
12	U000465	3/8"-16x1.5" hex cap screw GR8	8
13	U030800	Nut, lock, NY, #8-32	2
14	U030801	Washer flat #8	2
15	U030802	Screw, pan HD phil #8-32x.750	2
16	U030851	Screw, pan HD phil 1/4-20x1" GR 316	2
17	U120000	Nut, lock, NY, .250-20 ZP G2	2
18	U120114	Nut, lock, .375-16 NY YZ G8	8
19	U200020	Washer flat .250 ZP	4
20	U200085	3/8 SAE thru hard flat washer	16
21	8041236-015.00	Tape, 2" conspicuity, 15" LG	2
22	8041236-016.00	Tape, 2" conspicuity, 16" LG	2
23	8041236-021.00	Tape, 2" conspicuity, 21" LG	1
24	8041236-055.00	Tape, 2" conspicuity, 55" LG	2
25	8041236-067.00	Tape, 2" conspicuity, 67" LG	3
		Kit includes all items in Figure 1 parts list.	