



Technical Service Bulletin

Technical Service Bulletin:
TSB230067

Released Date: 17-Apr-2023

Safety Campaign #5215 – HGLAA Fuel Hose Leak

Safety Campaign #5215 – HGLAA Fuel Hose Leak

Warranty Statement

The information in this document authorizes specific changes to the repair practice for failures covered under product warranty coverages.

Contents

Product Affected

- HGLAA Spec A
- 2.8 HGLAA-8302 (Gasoline)
- 2.8 HGLAA-8303 (EVAP)

Issue

Symptom:

- Fuel line connection from fuel filter to the inlet of the Injection Pump Module (IPM) may not be secured properly

Root Cause:

- Incorrect hose used during assembly

Verification/Confirmation

- If the gasoline generator set has a serial number before B230206933, inspect to see if the fuel hose from filter to Injection Pump Module (IPM) has the specified colored writing on hose.

Refer to document **TSB230067-A Safety Campaign #5215 HGLAA Fuel Hose Leak Affected Generator Set Serial Numbers** for a table of affected units.

Resolution

Replace Oeitker (OET) clamp with new OET Clamps while using OET Pilers. Use Kit PN A073U493

See Service Instructions sections below, for proper fuel line, clamps, and installation instructions.

Service Instructions

1. If unit at OEM, unbox the unit from original packaging (not applicable for Installed Units).
2. Turn off the HGLAA generator set , Perform LOTO .
3. Remove the door enclosure (PN A062F793) by twisting the knob to open.

Note: If enclosure needs to be removed for adequate access be mindful of the enclosure tabs at the base pan.

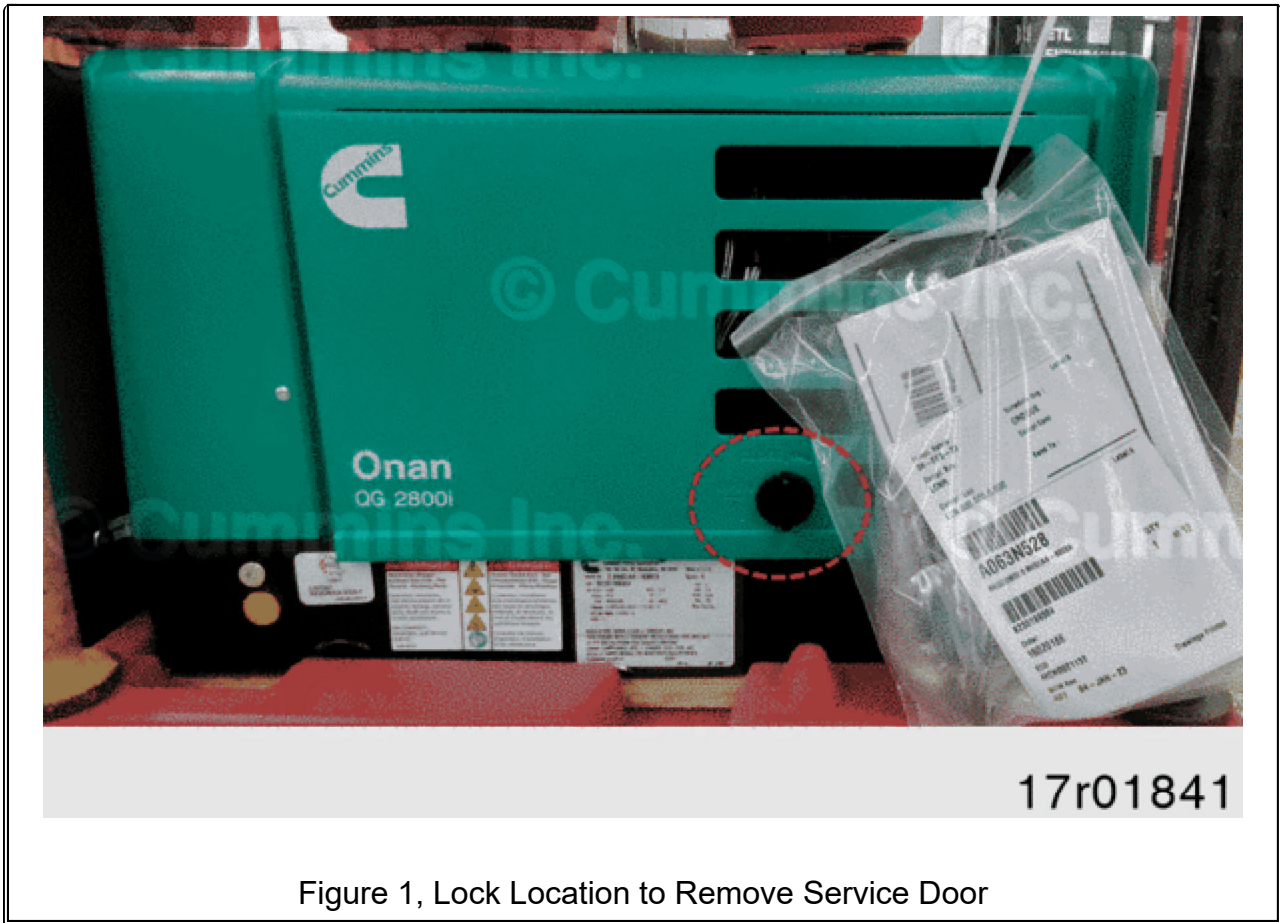

Figure 1, Lock Location to Remove Service Door

4. Remove top cover of air filter housing (PN A060W101) and filter by hand.

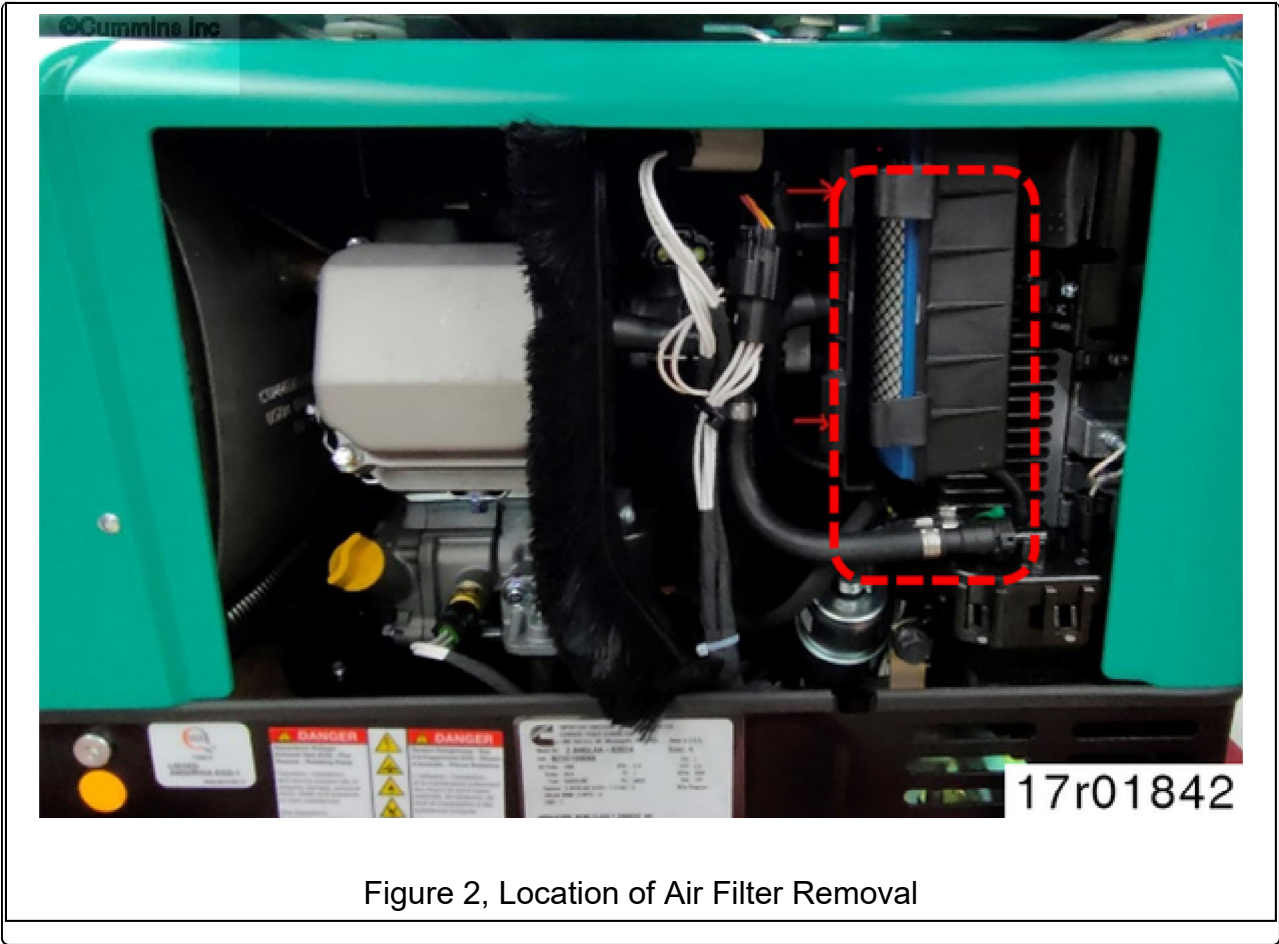
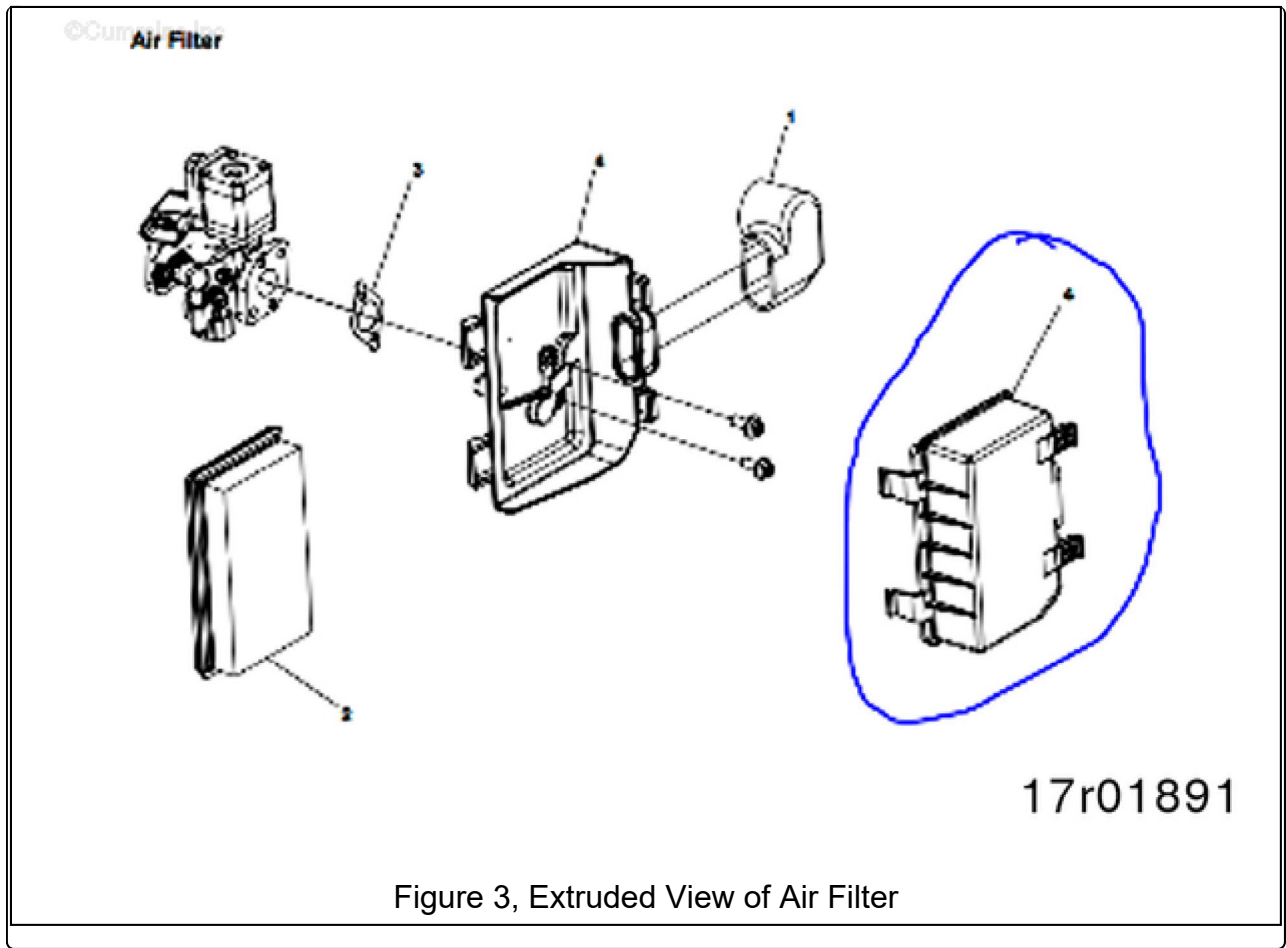
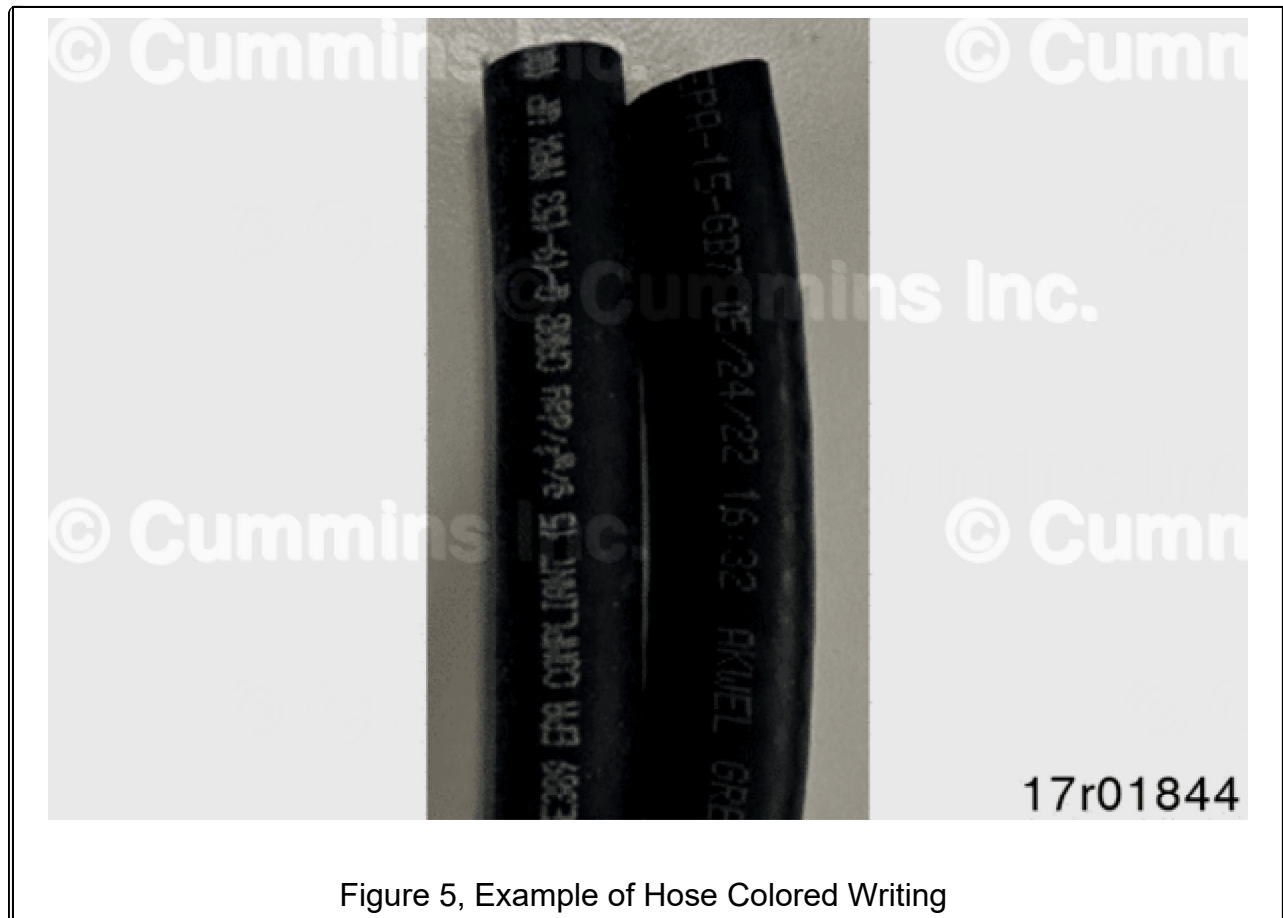

Figure 2, Location of Air Filter Removal







6. Unplug the fuel outlet hose (PN A057B741) using the quick disconnect feature. Pull the Green Part in the Direction of arrow, pull the green quick link lock upwards to release lock as indicated (in direction of arrow).

Safety consideration:

- a. Use cut resistant hand gloves and mask the cable tie before pulling the hose.
- b. Put a piece of cloth/cushioning material on the base frame to avoid any damage.
- c. After removal of fuel line, make sure that it is completely vertical, see figures below.

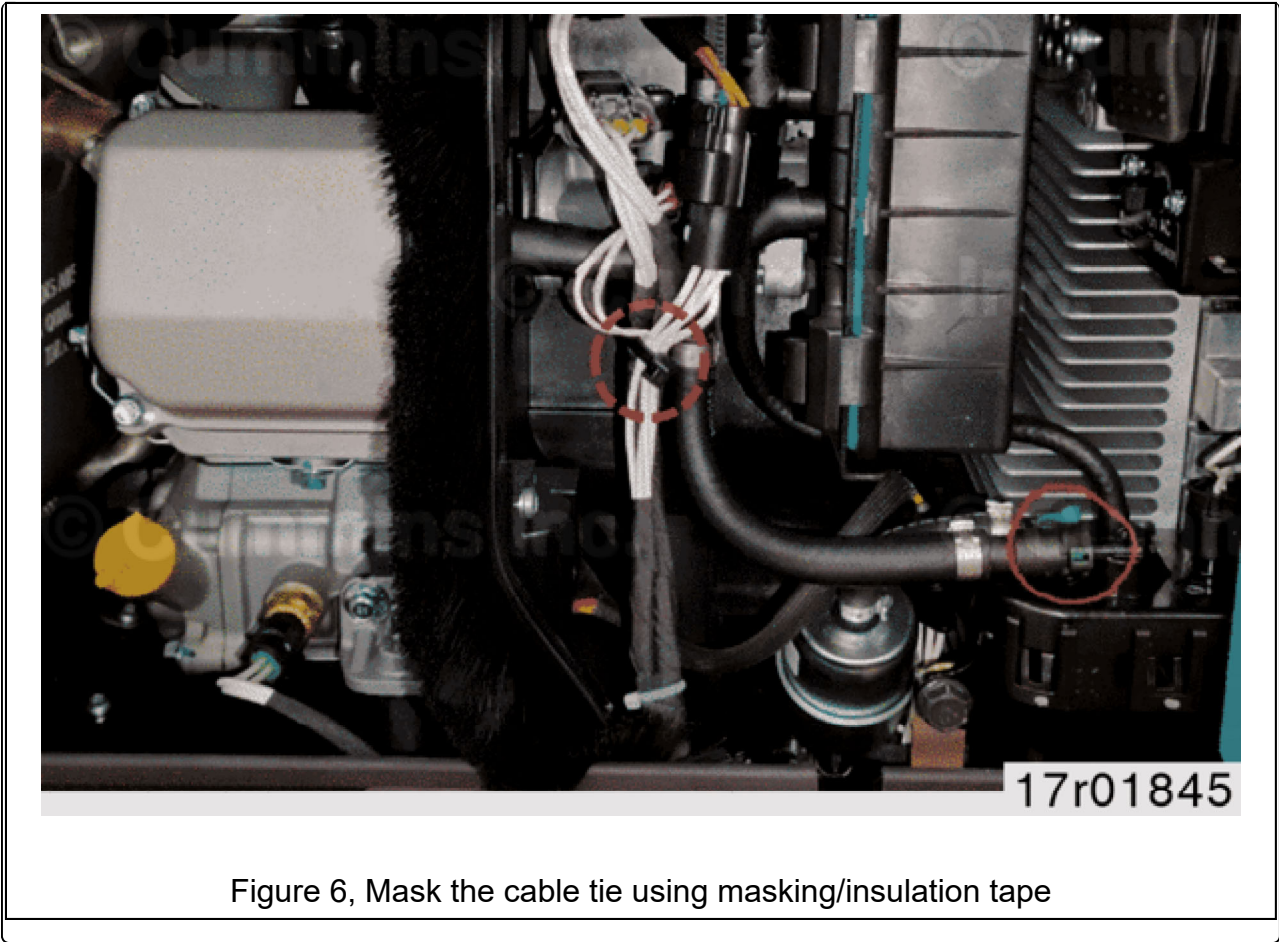

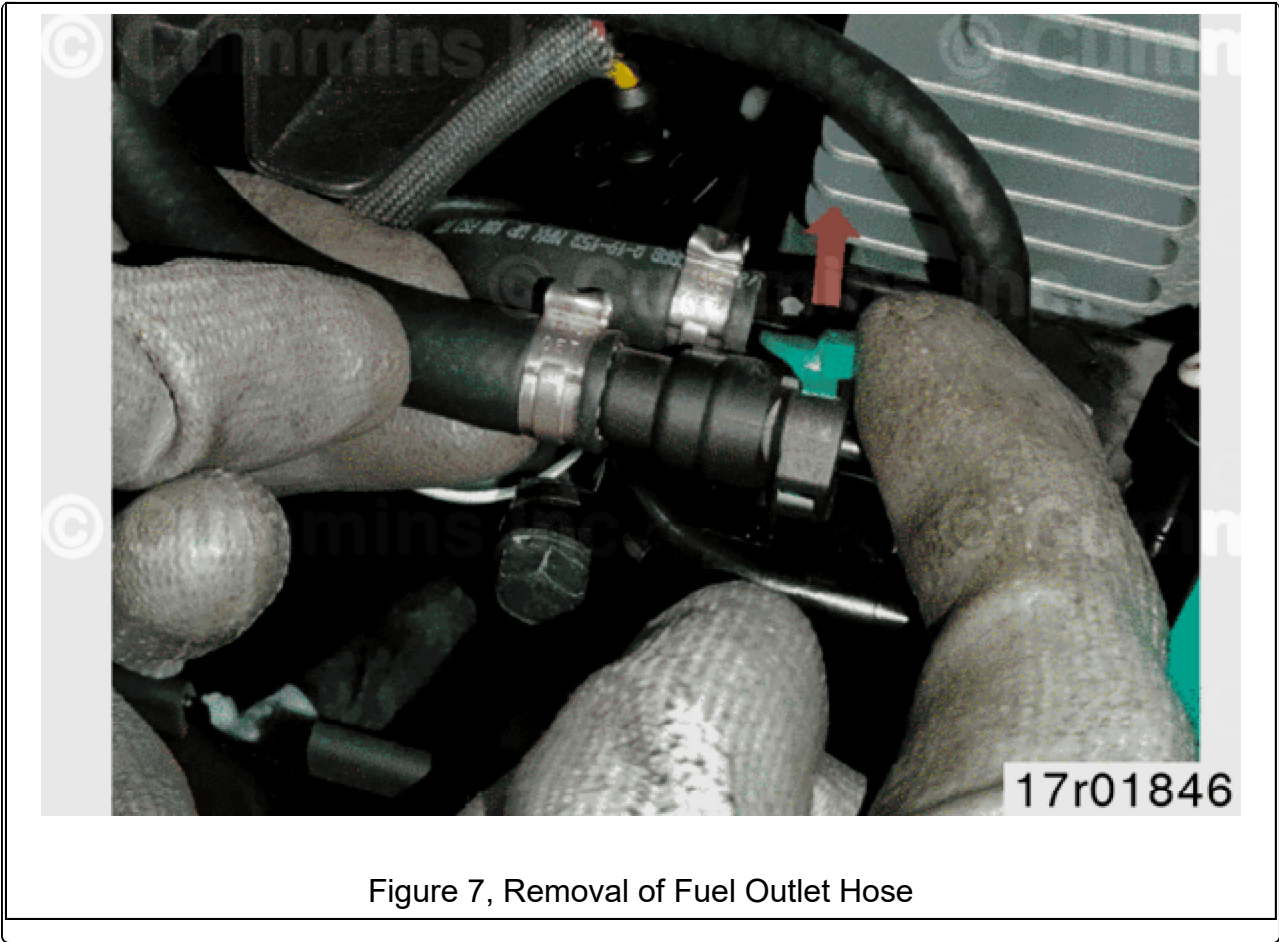

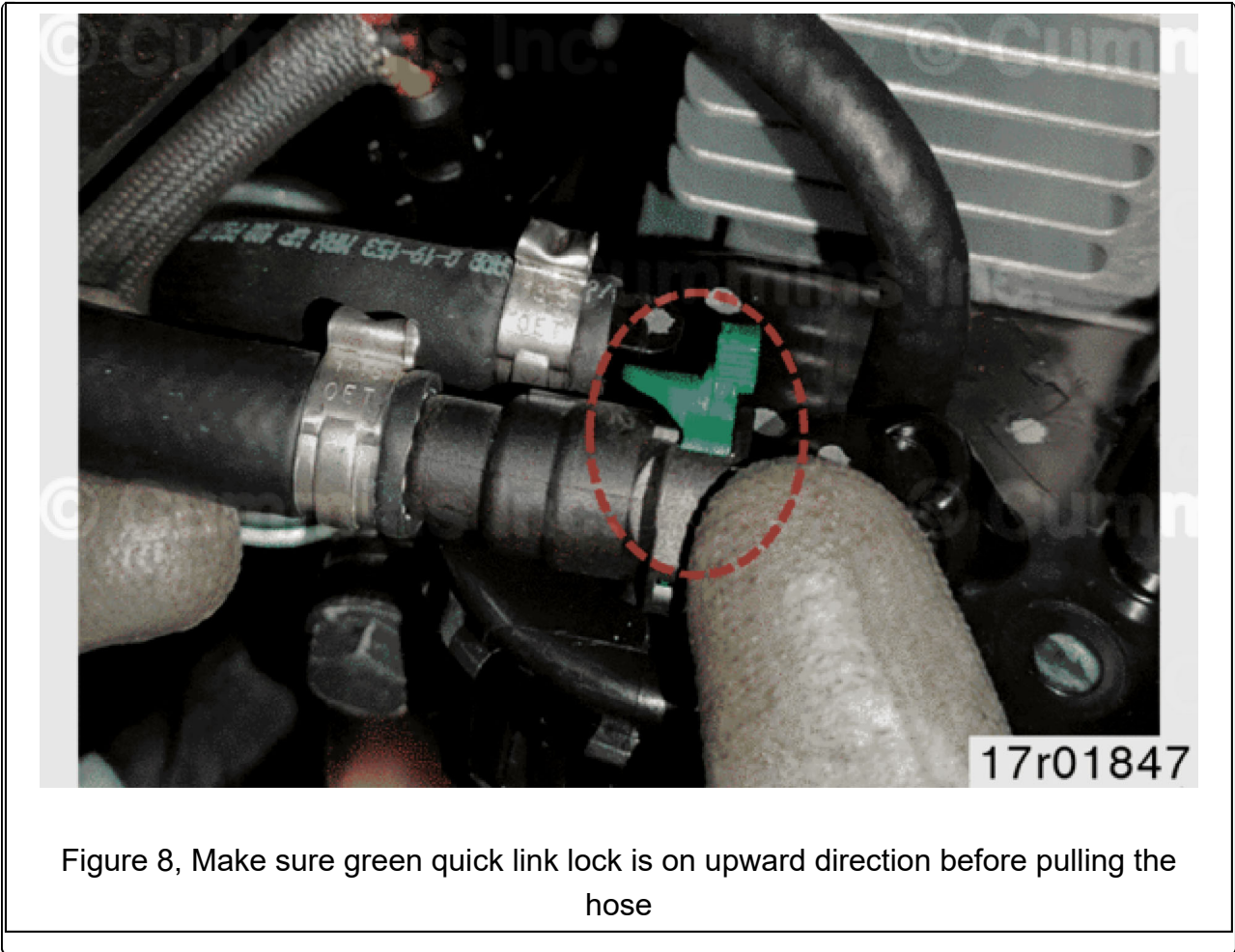

Figure 8, Make sure green quick link lock is on upward direction before pulling the hose

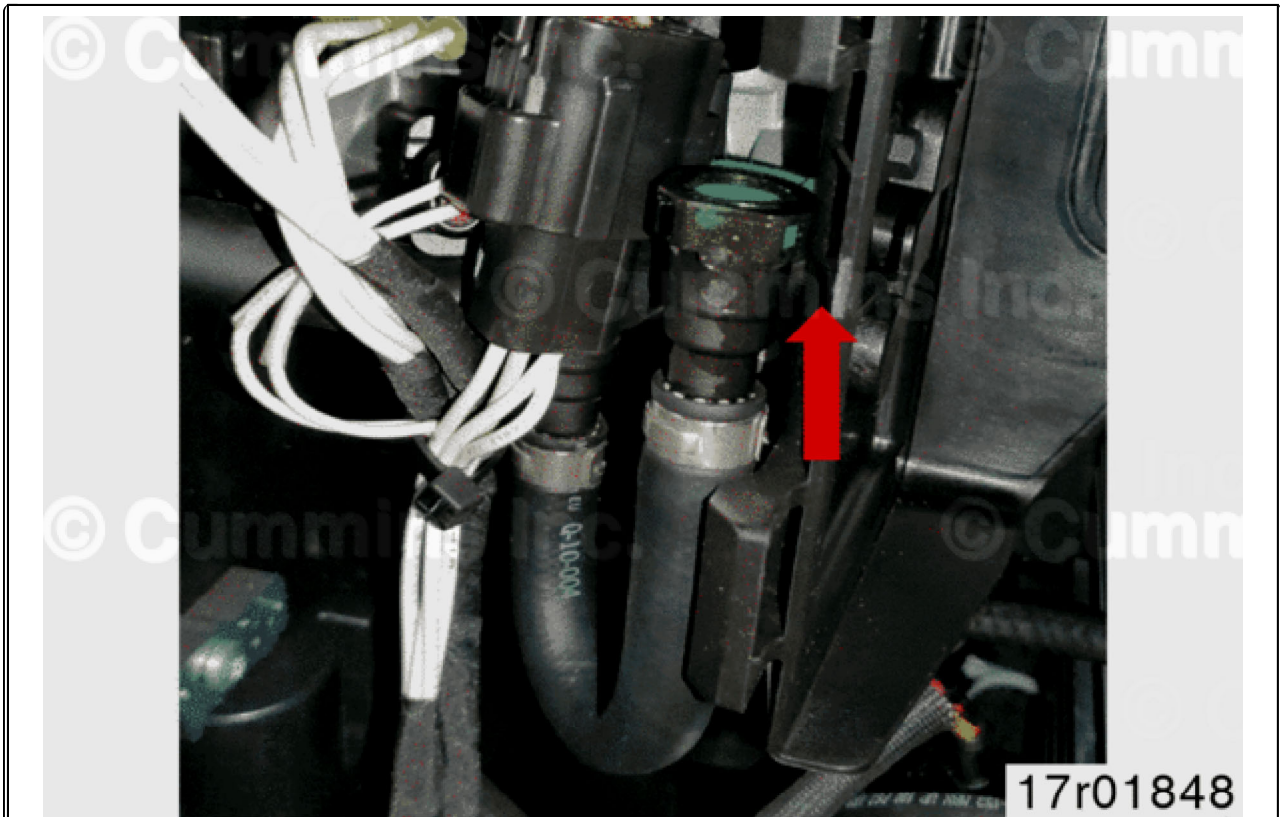

Figure 9, After disconnecting fuel line, ensure that it is completely vertical

7. Pull/disconnect inlet hose (PN A064P026) from IPM module (PN A057B750) by hand

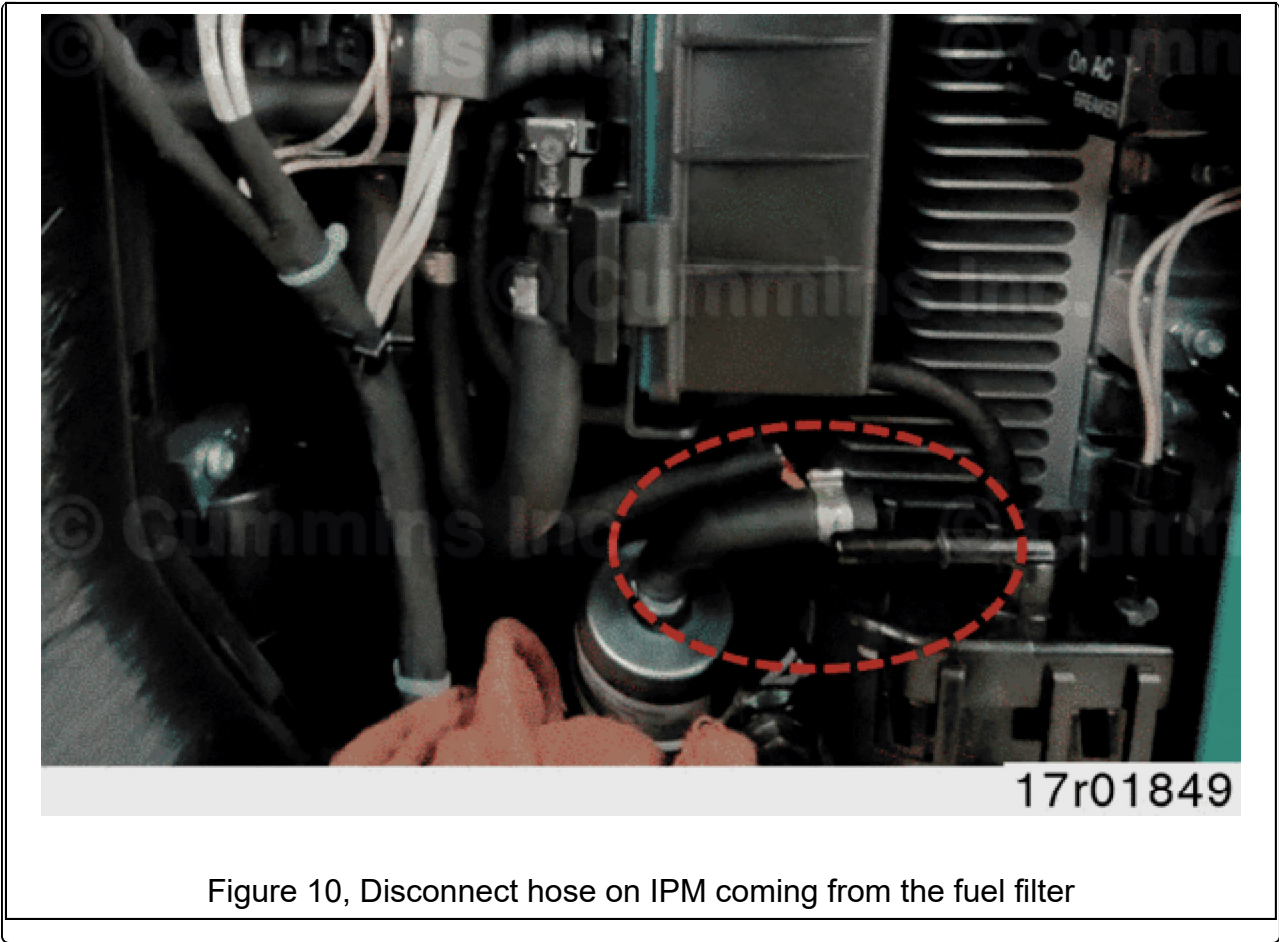



Figure 11, Pull the hose in the direction shown

8. Pull/disconnect inlet hose (PN A064P026) from fuel filter (PN A062A970) by hand (hold filter in one hand and pull hose with other hand). Use new fuel hose and install two 13.3 OET clamps.

Warning: Firmly hold the fuel filter while removing the inlet hose, be careful not to pull on the opposite side hose.

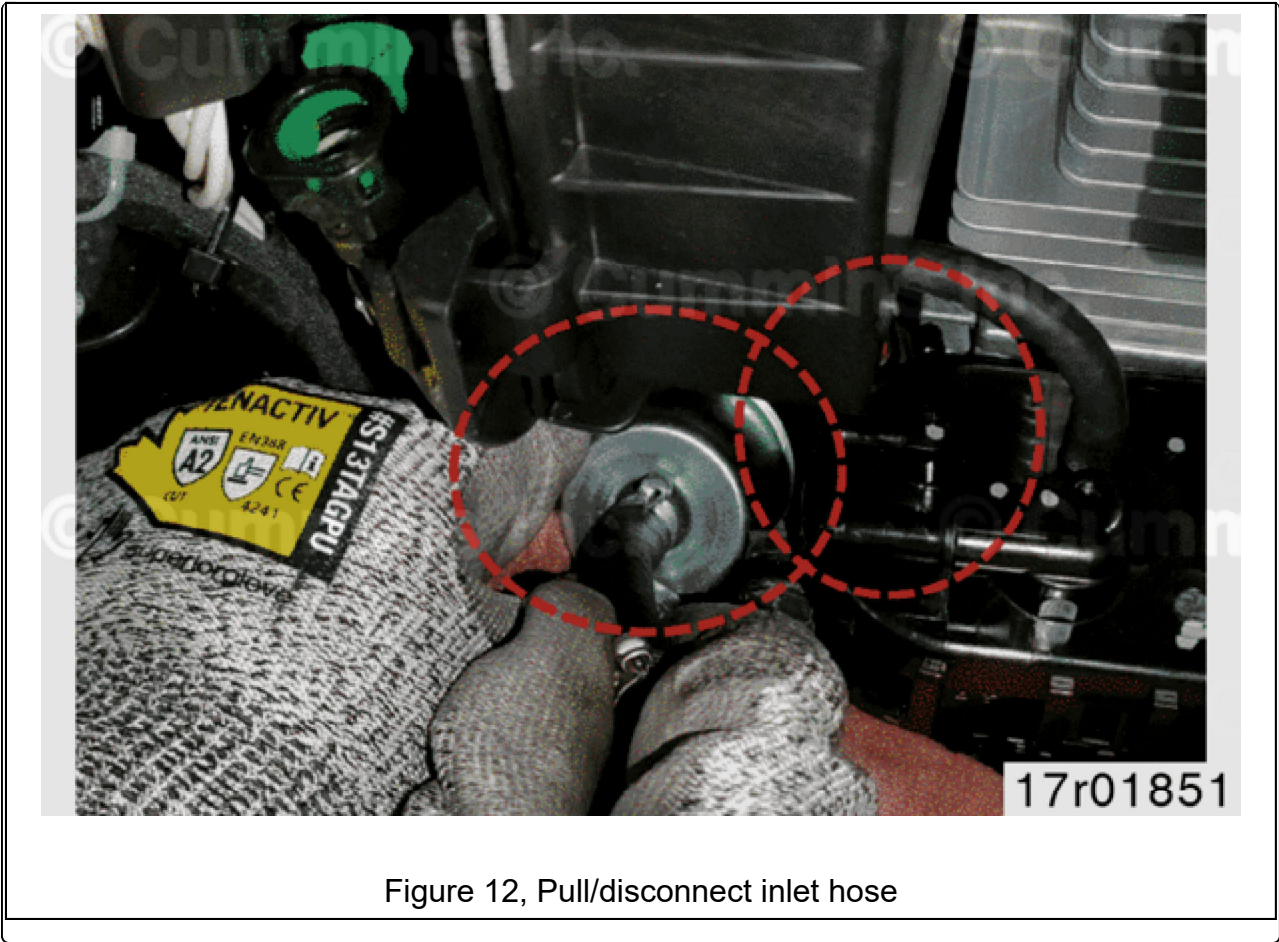



Figure 13, Use new fuel hose from the kit and install two 13.3 OET clamps

9. Connect one end of the new hose to fuel filter, clamp, and then connect the other end to IPM, and clamp.



Figure 14, Push new hose in the direction shown and make sure hose is fully onto the inlet connection



Figure 15, Install new clamps on hose (at filter end and at IPM end) before connecting hose to IPM.



Figure 16, Make sure second clamp is placed before connecting hose to IPM

10. Crimp the 13.3 OET clamp in the IPM joint using hand crimping tool. Special tool with length less than 180 mm, special tool length will result in not having to remove the enclosure

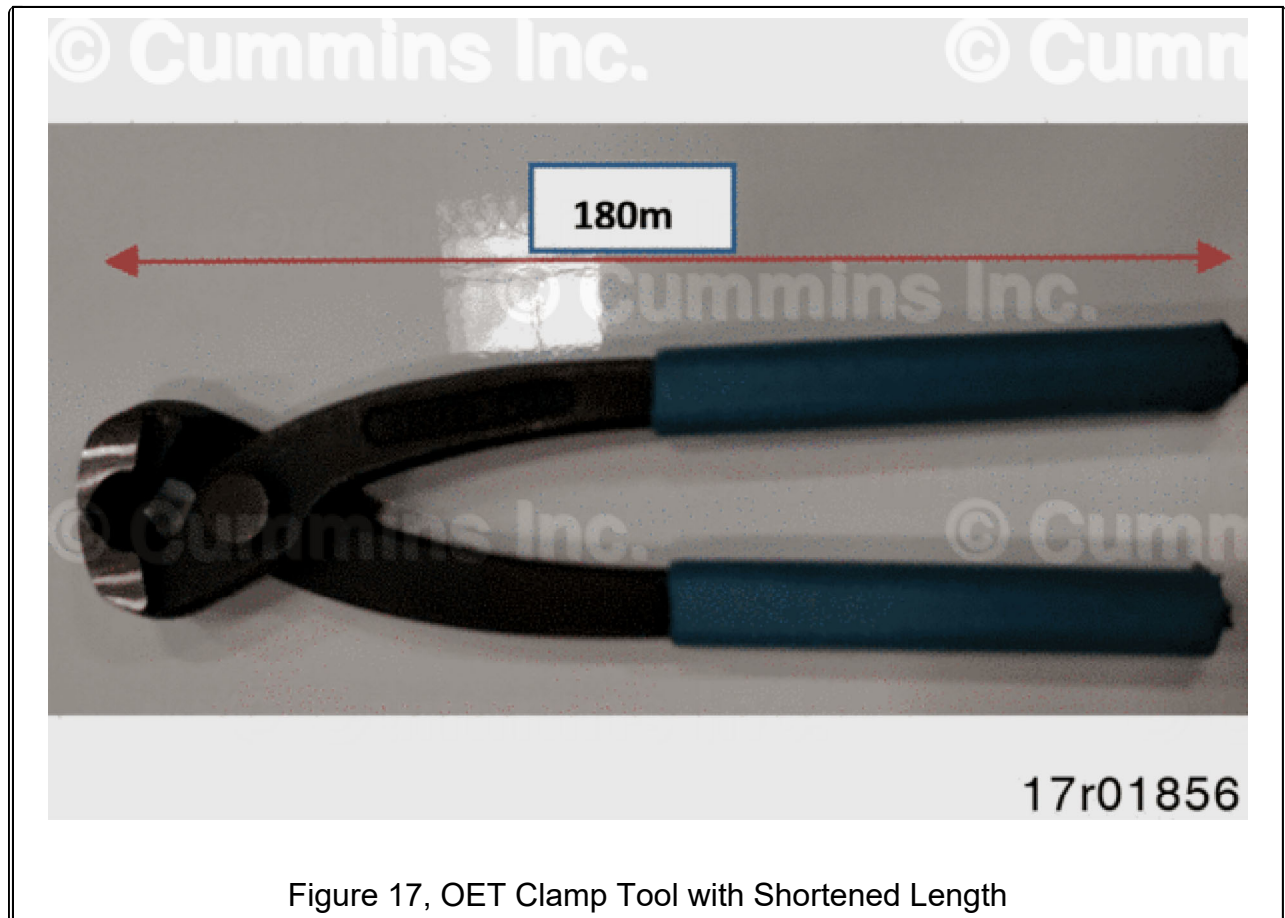
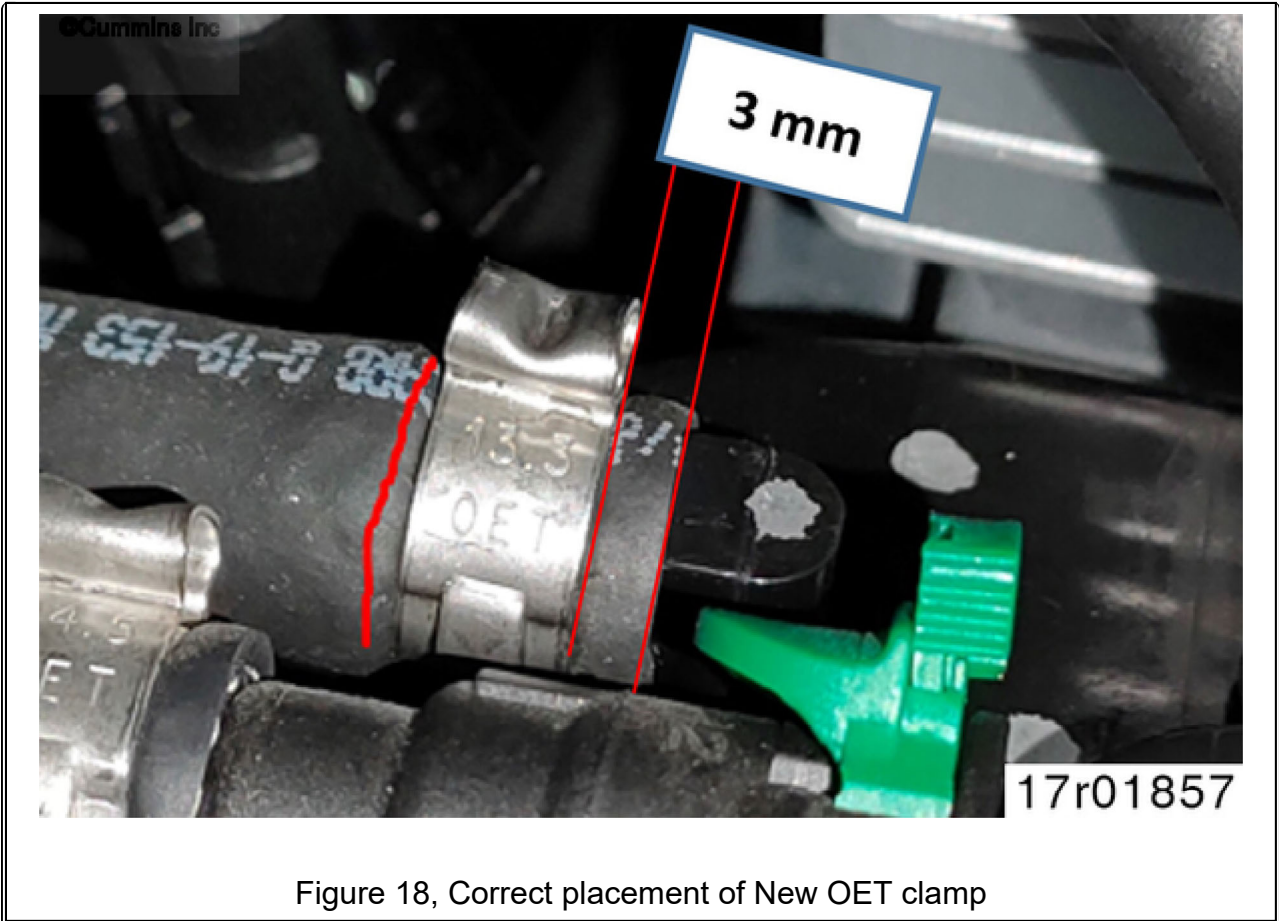
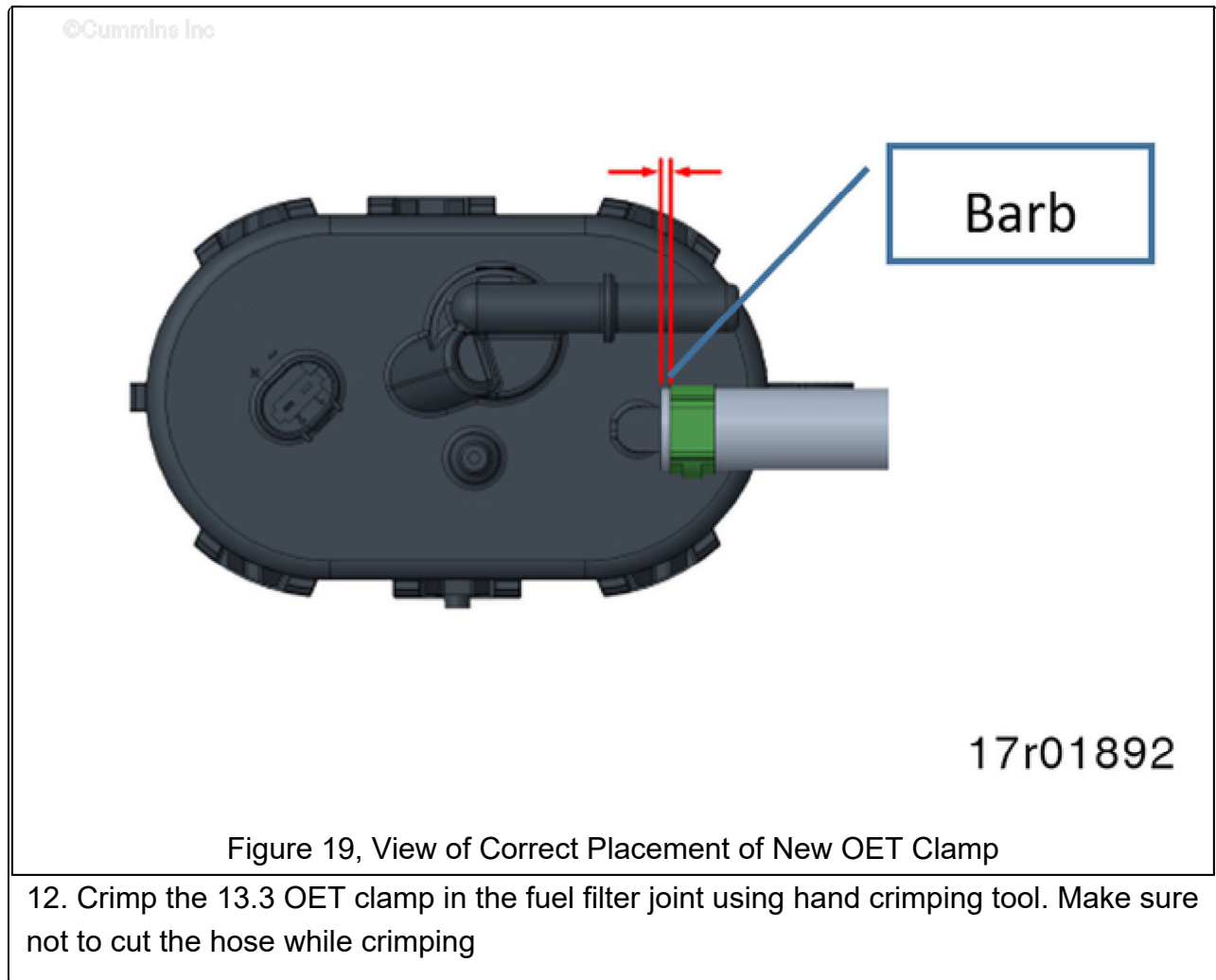
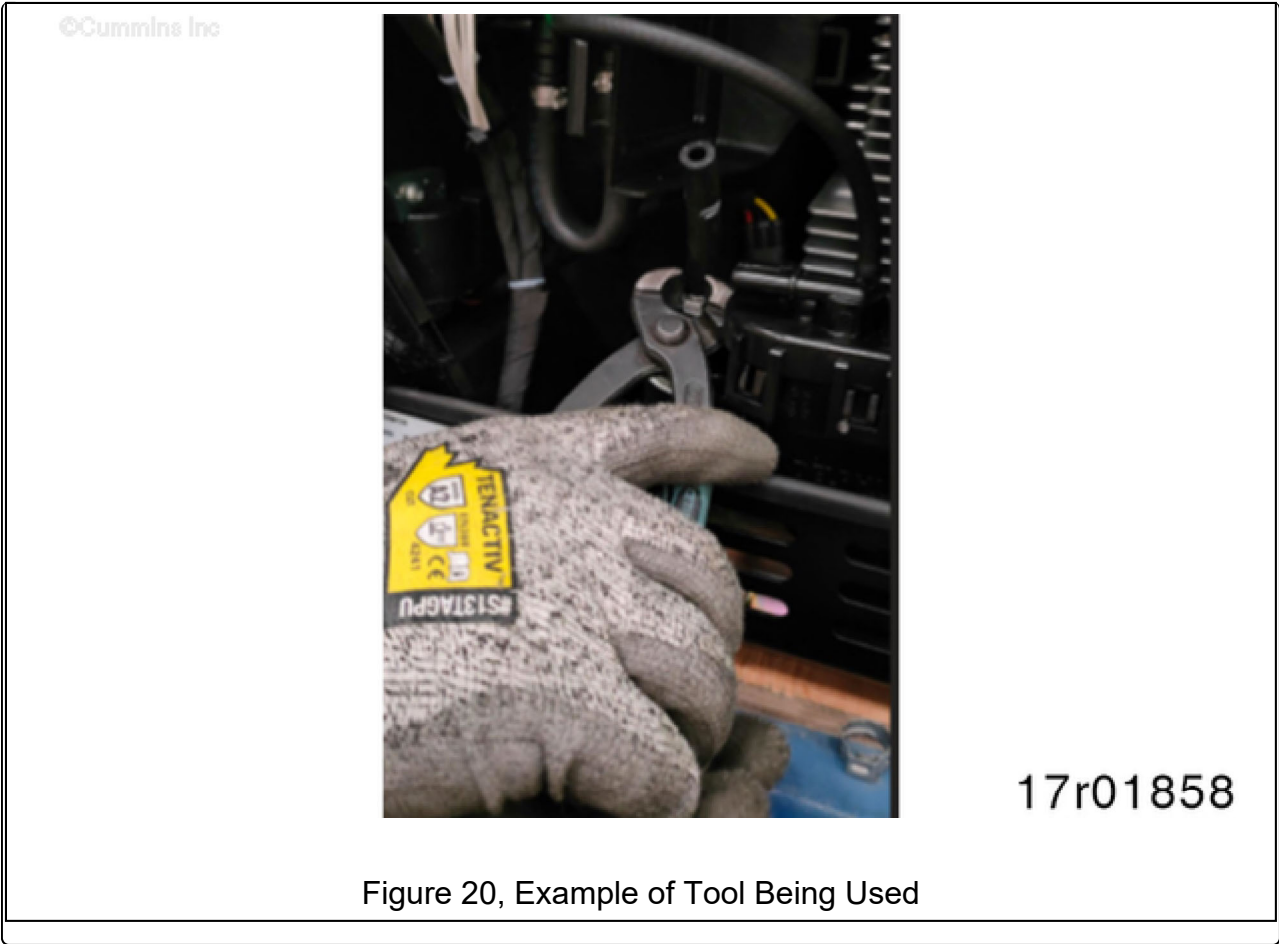

Figure 17, OET Clamp Tool with Shortened Length

11. Clamp position should be close to IPM (less than 3 mm). Visually check that the clamp does not seat on barb.







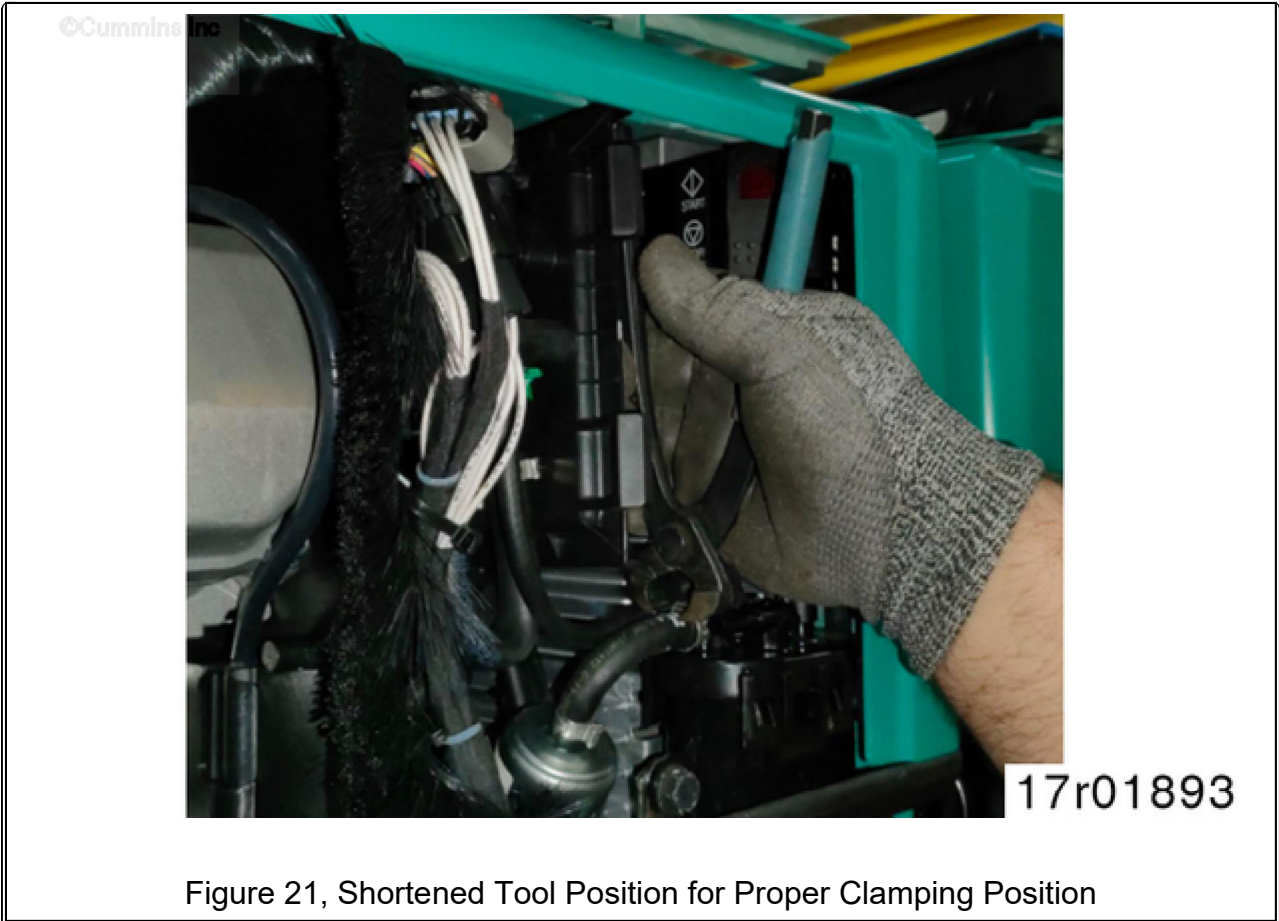

Figure 21, Shortened Tool Position for Proper Clamping Position

13. Plug the fuel outlet hose (A057B741) using the quick connect feature and lock the connector

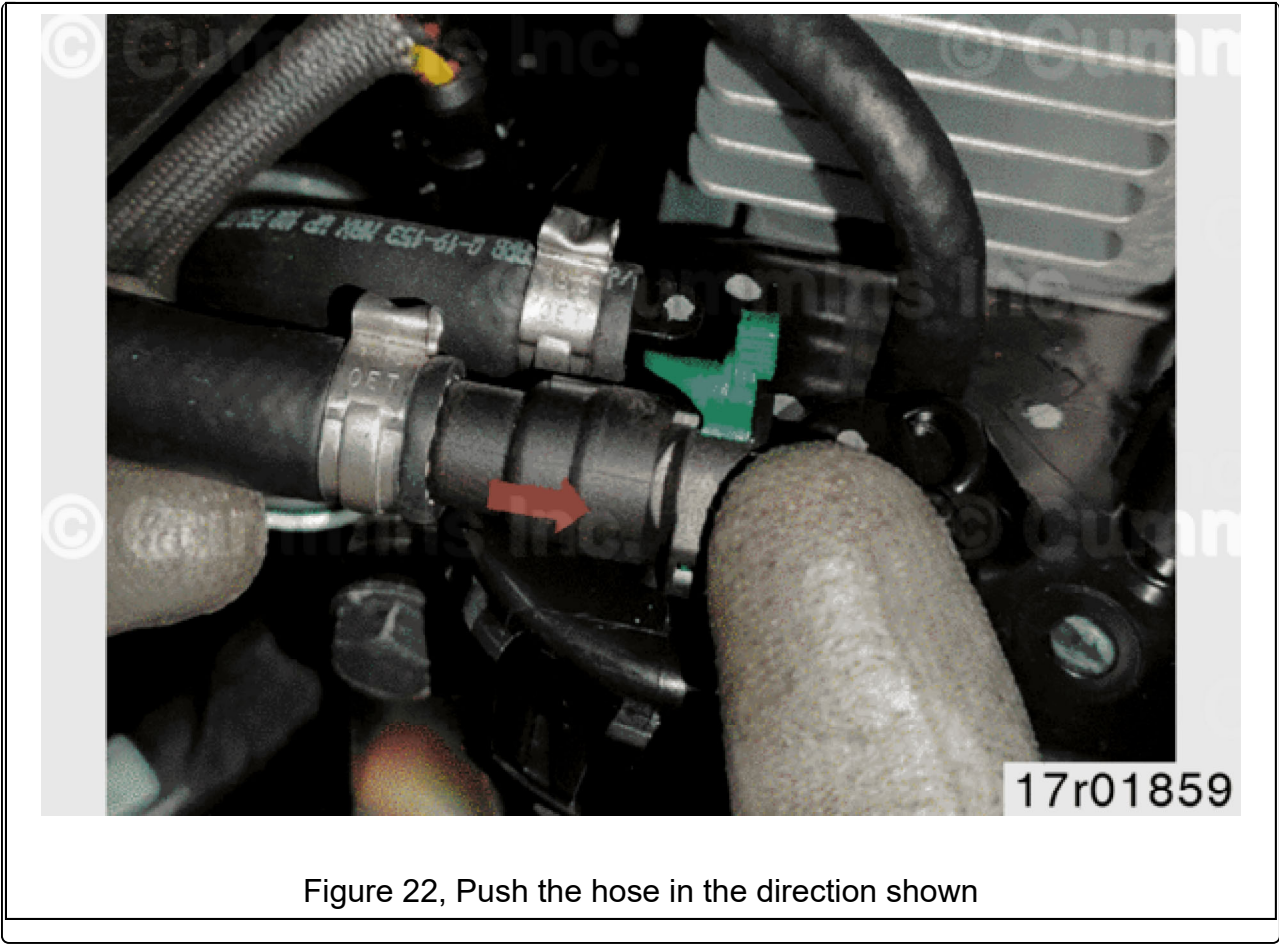

Figure 22, Push the hose in the direction shown

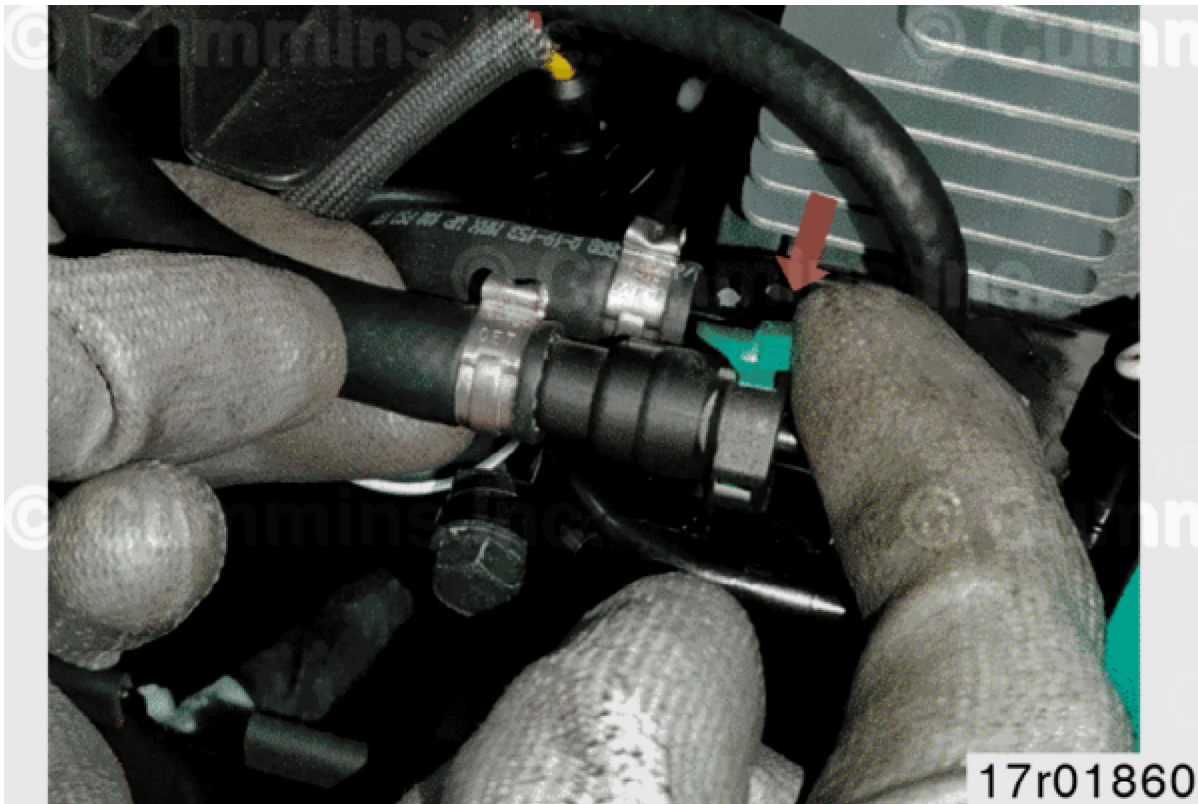

Figure 23, Push the green part in the direction shown to lock

14. Visually make sure all hoses are connected (no unconnected hose).
15. Quality check: Pull on the new hose (pull test) at both joints to make sure hose is clamped properly at filter and IPM side.
16. Reinstall air filter and air cleaner housing. Make sure tabs are locked properly

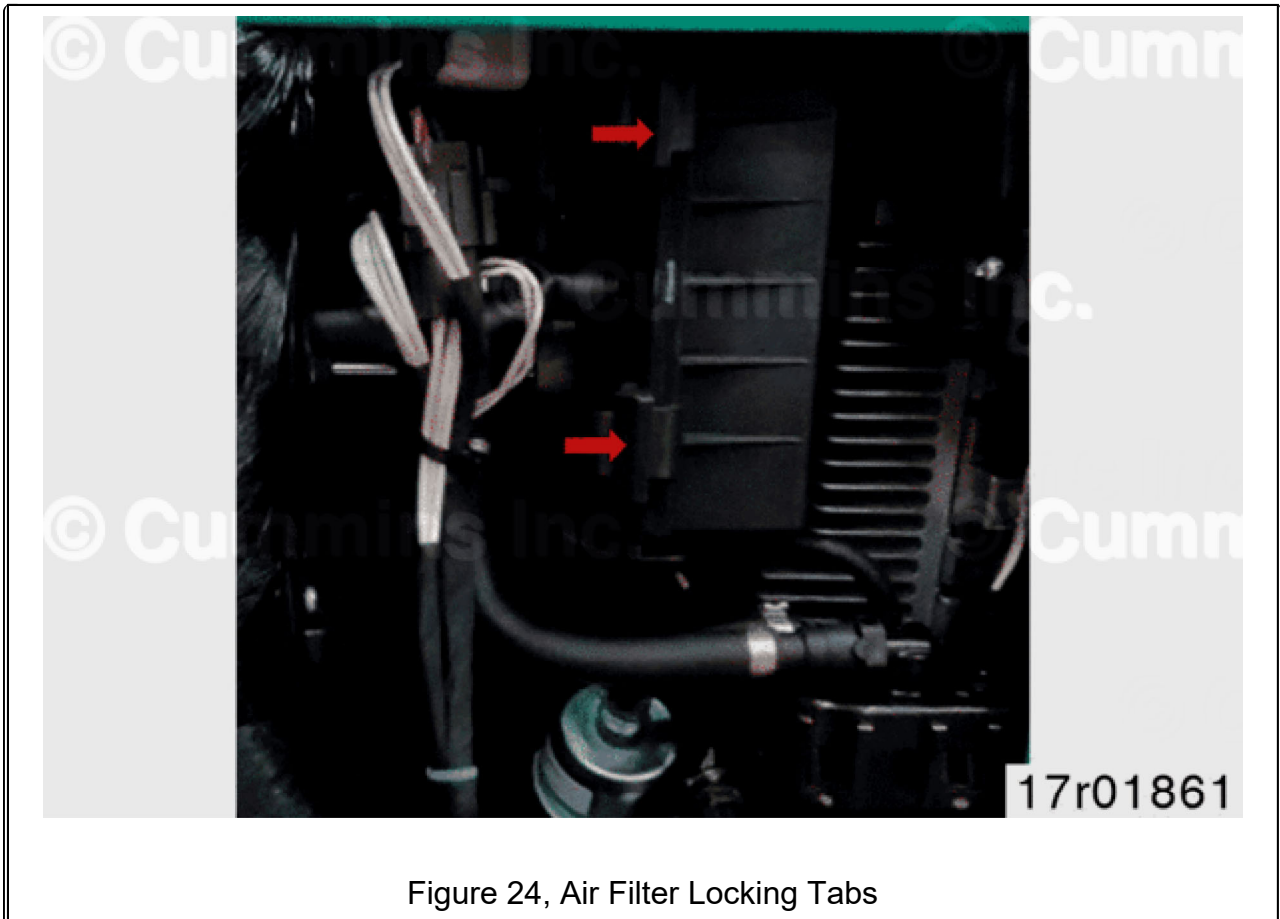

Figure 24, Air Filter Locking Tabs

17. Reinstall the door enclosure (PN A062F793) and close it by twisting the knob.



Figure 25, Generator Set After Fix

Table 1, Service Parts

| Part Description | Part Number |
|-----------------------|-------------|
| Kit, Hose with Clamps | A073U493 |

Service parts are available. See Table 1 for part numbers.

Production Status

Implemented for production. See Table 2.

Refer to document **TSB230067-A Safety Campaign #5215 HGLAA Fuel Hose Leak Affected Generator Set Serial Numbers** for a table of affected units.

Table 2, Production Information

| Product | GSN First | Build Date ¹ | Plant |
|---------|------------|-------------------------|---------|
| HGLAA | B230206933 | | Fridley |

¹Generator Set/Engine build date can be found on the Generator Set/engine dataplate.

Document History

| Date | Details |
|-----------|----------------|
| 2023-3-24 | Module Created |

Last Modified: 17-Apr-2023
