



Stacy L. Balzer
Operating Director
Service Engineering Operations
Ford Customer Service Division

Ford Motor Company
P. O. Box 1904
Dearborn, Michigan 48121

September 11, 2023

TO: All U.S. Ford and Lincoln Dealers

**SUBJECT: NEW VEHICLE DEMONSTRATION / DELIVERY HOLD
Safety Recall 23S35**

Certain 2021-2023 Model Year F-150 Vehicles with Single Exhaust
Repair Rear Axle Wire Harness Chafe

AFFECTED VEHICLES

Vehicle	Model Year	Assembly Plant	Build Dates
F-150	2021	Dearborn Assembly	January 8, 2020 through November 22, 2021
	2022		September 14, 2021 through October 24, 2022
	2023		May 6, 2022 through February 24, 2023
	2021	Kansas Assembly	February 12, 2020 through December 20, 2021
	2022		October 13, 2021 through November 18, 2022
	2022		June 11, 2022 through February 25, 2023

US population of affected vehicles: 870,634. Affected vehicles are identified in OASIS and FSA VIN Lists.

Note: Some vehicles may be in the process of being repaired at the plant. Monitor OASIS before opening an RO and/or beginning a repair. Parts purchased for an FSA can be returned for credit if required. See the EXCESS STOCK RETURN details in Attachment II for more information.

REASON FOR THIS SAFETY RECALL

In some of the affected vehicles, the rear axle wire harness may contact the rear axle housing and chafe over an extended period of time, damaging the electric parking brake wiring. Damaged electric parking brake wiring may lead to inadvertent parking brake application while driving, potentially resulting in loss of control of the vehicle and increasing the risk of a crash.

SERVICE ACTION

Before demonstrating or delivering any new in-stock vehicles involved in this recall, dealers are to inspect the rear axle wire harness for chafing and repair with the technical instructions provided. This service must be performed on all affected vehicles at no charge to the vehicle owner.

OWNER NOTIFICATION MAILING SCHEDULE

Owner letters are expected to be mailed the week of September 11, 2023. Dealers should repair any affected vehicles that arrive at their dealerships, whether or not the customer has received a letter.

PLEASE NOTE:

Federal law requires dealers to complete this recall service before a new vehicle is delivered to the buyer or lessee. Violation of this requirement by a dealer could result in a civil penalty of up to \$26,315 per vehicle. Correct all vehicles in your new vehicle inventory before delivery.

ATTACHMENTS

- Administrative Information
- Allowances and Parts Ordering Information
- Technical Information
- Mobile Service Repair Assessment
- Vehicle Pickup and Delivery Record
- Owner Notification Letters
- Recall Reimbursement Plan
- Interim Repair Notification

QUESTIONS & ASSISTANCE

For questions and assistance, contact the Special Service Support Center (SSSC) via the SSSC Web Contact Site. The SSSC Web Contact Site can be accessed through the Professional Technician System (PTS) website using the SSSC link listed at the bottom of the OASIS VIN report screen or listed under the SSSC tab.

Sincerely,

Stacy L. Balzer

Safety Recall 23S35

MOBILE SERVICE REPAIR ASSESSMENT LEVEL

- All repairs in this program have the following assessment level.
 - Enhanced Mobile Service

MOBILE REPAIR RECOMMENDATIONS

- Confirm with the customer a mobile repair is feasible.
- Check OASIS before going to the customer's home or business to confirm if any other outstanding FSA needs to be completed.
- Transportation – due to the simplicity of this repair, a specialty vehicle is not required.

MOBILE REPAIR ADDITIONAL INFORMATION

Please ensure the technician brings the following to the mobile repair destination:

- Printed Technical Instructions
- Printed Repair/Work Order or any other necessary documentation as customer copy(s)
 - Documents could also be emailed to the customer.
- Shirt/uniform and vehicle graphic with the dealership or Ford logos are recommended.
- Recommended specialty tools: floor jack, jack stands, flashlight, wire repair kit.

MOBILE REPAIR QUESTIONS AND ASSISTANCE

- For questions and assistance, contact the Special Service Support Center (SSSC) via the SSSC Web Contact Site. Work with Dealership warranty administrator to create a SSSC contact ID#.
- Once an SSSC agent responds to the new contact ID#, you may opt to call the SSSC hotline: (800) 325-5621.

MOBILE REPAIR CLAIMING QUESTIONS

Dealers participating in the Remote Experience Program:

- Refer to Electronic Field Communication - EFC12071 2023 Remote Experience Program.

OASIS ACTIVATION

OASIS will be activated on September 11, 2023.

FSA VIN LISTS ACTIVATION

FSA VIN Lists will be available through <https://web.fsavinlists.dealerconnection.com> on September 11, 2023 Owner names and addresses will be available by September 25, 2023.

NOTE: Your FSA VIN Lists may contain owner names and addresses obtained from motor vehicle registration records. The use of such motor vehicle registration data for any purpose other than in connection with this recall is a violation of law in several states, provinces, and countries. Accordingly, you must limit the use of this listing to the follow-up necessary to complete this recall.

Safety Recall 23S35

SOLD VEHICLES

- Ford has not issued instructions to stop selling/delivering or driving used vehicles under this safety recall. Owners should contact their dealers for an appointment to have their vehicles remedied as soon as practicable.
- Immediately contact any of your affected customers whose vehicles are not on your VIN list but are identified in OASIS. Give the customer a copy of the Owner Notification Letter (when available) and schedule a service date.
- Correct other affected vehicles identified in OASIS which are brought to your dealership.
- Dealers are to prioritize repairs of customer vehicles over repairs of new and used vehicle inventory.

STOCK VEHICLES

- Correct all affected units in your new vehicle inventory before delivery.
- Use OASIS to identify any affected vehicles in your used vehicle inventory.

DEALER-OPERATED RENTAL VEHICLES

The Fixing America's Surface Transportation (FAST) Act law effective June 2016 prohibits a rental company from selling, renting, or leasing vehicles subject to a safety or compliance recall. Please consult your legal counsel for legal advice.

BRANDED / SALVAGED TITLE VEHICLES

Affected branded/salvaged title vehicles are eligible for this recall.

OWNER REFUNDS

- **This safety recall must still be performed, even if the owner has paid for a previous repair. Claiming a refund will not close the recall on the vehicle.**
- Ford Motor Company is offering a refund for owner-paid repairs covered by this recall if the repair was performed before the date indicated in the reimbursement plan, which is posted with this bulletin. Owners are directed to seek reimbursement through authorized dealers or, at their option, directly through Ford Motor Company at P.O. Box 6251, Dearborn, MI 48121-6251.
- Dealers are also pre-approved to refund owner-paid emergency repairs that were performed away from an authorized servicing dealer after the end date specified in the reimbursement plan. Non-covered repairs, or those judged by Ford to be excessive, will not be reimbursed.
- Refunds will only be provided for the cost associated with the rear axle wire harness chafe.

RENTAL VEHICLES

Rental vehicles are not approved for this program.

PICK-UP AND DELIVERY- Participating Dealers

Dealers participating in the Remote Experience Program:

- Refer to EFC12071, 2023 Remote Experience Program, Pickup & Delivery (PDL) Offset section for additional details.

Safety Recall 23S35**PICK-UP AND DELIVERY- Non-participating Dealers**

Dealers not participating in the 2023 Remote Experience Program for Pick-up & Delivery are authorized to claim unique services for completing this program.

- Dealers are authorized to claim one-half labor hour per repair for vehicle pick-up & delivery services. Refer to Labor Allowances for details.
- Dealers must retain a Vehicle Pick-up & Delivery Record with the repair order documentation.

ADDITIONAL REPAIR (LABOR TIME AND/OR PARTS)

Additional repairs identified as necessary to complete the FSA should be managed as follows:

- For related damage and access time requirements, refer to the Warranty and Policy Manual / Section 6 – Ford & Lincoln Program Policies / General Information & Special Circumstances for FSAs / Related Damage.
- For vehicles within new vehicle bumper-to-bumper warranty coverage, no SSSC approval is required, although related damage must be on a separate repair line with the “Related Damage” radio button checked.
 - Ford vehicles – 3 years or 36,000 miles
- For vehicles outside new vehicle bumper-to-bumper warranty coverage, submit an Approval Request to the SSSC Web Contact Site before completing the repair.

CLAIMS PREPARATION AND SUBMISSION

- **Claim Entry:** Enter claims using Dealer Management System (DMS) or One Warranty Solution (OWS) online.
 - When entering claims, select claim type 31: Field Service Action. The FSA number (23S35) is the subcode.
 - For additional claims preparation and submission information, refer to the Recall and Customer Satisfaction Program (CSP) Repairs in the OWS User Guide.
- **Related Damage/Additional labor and/or parts:** Must be claimed as Related Damage on a separate repair line from the FSA with the same claim type and subcode as described in Claim Entry above.

IMPORTANT: Click the Related Damage Indicator radio button.

- **Refunds:** Submit refunds on a separate repair line.
 - Program Code: 23S35 - Misc. Expense: ADMIN
 - Misc. Expense: REFUND - Misc. Expense: 0.2 Hrs.
 - Multiple refunds should be submitted on one repair line and the invoice details for each repair should be detailed in the comments section of the claim.
- **Pickup & Delivery:**
 - Dealers participating in the Remote Experience Program –
 - Refer to EFC12071, 2023 Remote Experience Program, Pickup & Delivery (PDL) Offset section for additional details.
 - Dealers NOT participating in the Remote Experience Program –
 - Dealers are authorized to claim one-half labor hour per repair for vehicle pick-up and delivery services.
 - Dealers must retain a Vehicle Pick-up and Delivery Record with the repair order documentation.

Safety Recall 23S35

CLAIMS PREPARATION AND SUBMISSION (Continued)

- **Mobile Repair:**
 - Dealers participating in the Remote Experience Program –
 - Refer to Electronic Field Communication - EFC12071 2023 Remote Experience Program.
- **Provision for Locally Obtained Supplies:** Includes (Tape / Tie Strap). Submit on the same line as the repair.
 - Program Code: 23S35
 - Misc. Expense: MISC OTHER
 - Misc. Expense: Claim up to \$2.50

Safety Recall 23S35

LABOR ALLOWANCES

Description	Labor Operation	Labor Time
Inspect and repair EPB wire harness, does not pass inspection , solder and shrink-wrap the damaged wires in the harness as required and install the tie strap and tape to the wire harness and rear axle mounting clip. Print off and place the Interim Repair form on the front passenger seat. This labor operation does not close this Recall.	MT23S35AA	M-Time up to 1.8 Hours
Inspect EPB wire harness, does pass inspection , install tie strap and tape to the wire harness, and rear axle mounting clip. This labor operation will close this Recall.	23S35B	0.4 Hours
Vehicle Pick-up and Delivery Allowance: This allowance is only for non-eligible 2023 Remote Experience Program Dealers. NOTE: This allowance is for dealer-performed vehicle pick-up/delivery for dealership repairs only. Can only be claimed once, regardless of outstanding FSAs repaired.	23S35PP	0.5 Hours

PARTS REQUIREMENTS / ORDERING INFORMATION

Part Number	Description	Order Quantity	Claim Quantity
NAIPOLYKEN650 Order through Rotunda RTTP	Polyken 650 Tape ¾ width (One sleeve of 6 rolls One roll will service multiple vehicles)		Claim as Misc. Other
NAIT255R0HIRX2-L Order through Rotunda RTTP	Cable Tie (Zip Tie) (50 in pkg 1 needed for repair)		
CU2Z-14S411-ADA	Wire Repair Kit		If required

Order your parts through normal order processing channels. To guarantee the shortest delivery time, an emergency order for parts must be placed.

DEALER PRICE

For the latest prices, refer to DOES II.

PARTS RETENTION, RETURN, & SCRAPPING

Follow the provisions of the Warranty and Policy Manual, Section 1 - WARRANTY PARTS RETENTION AND RETURN POLICIES. If a replaced part receives a scrap disposition, the part must be scrapped by all applicable local, state, and federal environmental protection and hazardous material regulations. Federal law prohibits selling motor vehicle parts or components that are under safety, compliance, or emissions recall.

Safety Recall 23S35

EXCESS STOCK RETURN

The excess stock returned for credit must have been purchased from Ford Customer Service Division by Policy Procedure Bulletin 4000.

REPLACED FSA PARTS INSPECTION AND SIGN OFF

Effective March 1st, 2021, all parts replaced as part of an FSA repair with a repair order open date of March 1st, 2021, or later must be inspected and signed off on the repair order by a member of your dealer fixed operations management team or an employee of the task has been delegated to. If the task is to be delegated to a non-management employee, the employee needs to be someone other than the technician who completed the repair and needs to understand the importance of completing this task consistently and accurately.

- All parts replaced as part of an FSA repair should be returned to the parts department following the Warranty Parts Retention and Return Policies.
- Inspect the replaced parts to verify the FSA repair was completed.
- If the FSA repair is found to be complete, the designated employee signs the repair order line or parts return stamp area (electronic or hand signed) for the FSA repair indicating the parts were inspected and validated to have been replaced.
- After the parts have been inspected, they should be handled based on the guidance in the parts status report in the Online Warranty System (Hold, Return, CORE, Scrap, etc.).
- This process is subject to review during warranty audits for FSA repairs with a repair order open date of March 1st, 2021, or later. Any eligible FSA claims requiring parts replacement found not to have been inspected and signed off during a warranty audit will be subject to chargeback and consideration for enrollment into the Dealer Incomplete Recall Repair Process.

Note: Other approvals (electronic or handwritten) for add-on repair lines, dealer-owned vehicle repairs, and repeat repairs do not qualify as FSA parts inspection approvals. The post-repair FSA parts inspection process (electronic or handwritten) is independent of other warranty approval requirements. The approval by the designated employee implies that the FSA parts were found to be replaced and must be able to be identified on the Repair Order. If multiple FSAs require approval on a single Repair Order, each applicable occurrence will require individual post-repair approval by the designated employee.

CERTAIN 2021-2023 MODEL YEAR F-150 VEHICLES EQUIPPED WITH SINGLE EXHAUST — REAR WHEEL SPEED SENSOR HARNESS REWORK

SERVICE PROCEDURE

INSPECTION

1. Use a clean wet shop rag and clean the wire harness contact location and the full circumference of the wire harness. It needs to be clean to allow for the tape being applied in this repair to properly adhere to the wire harness. See Figure 1.

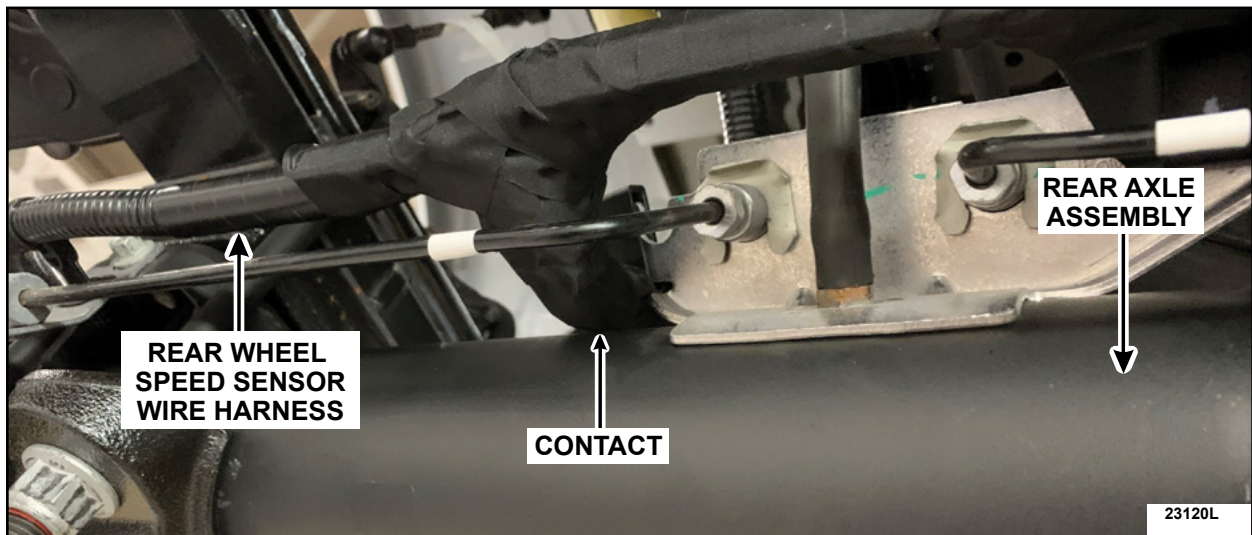

FIGURE 1

2. Disconnect the rear differential electrical connector. See Figure 2.

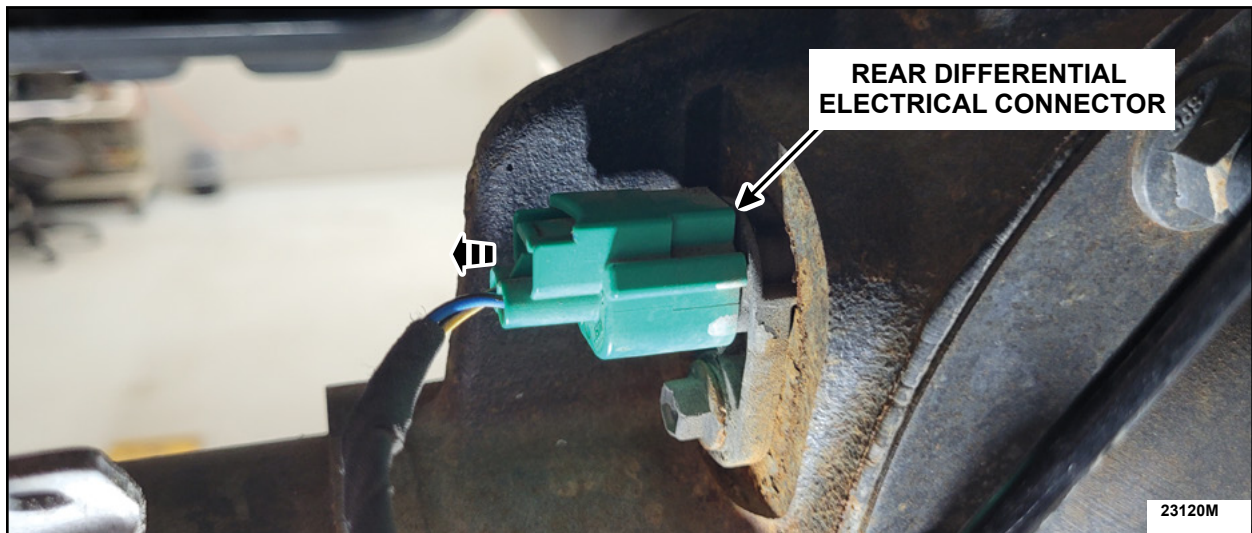

FIGURE 2



3. Locate the locking tab on the shield. See Figure 3.

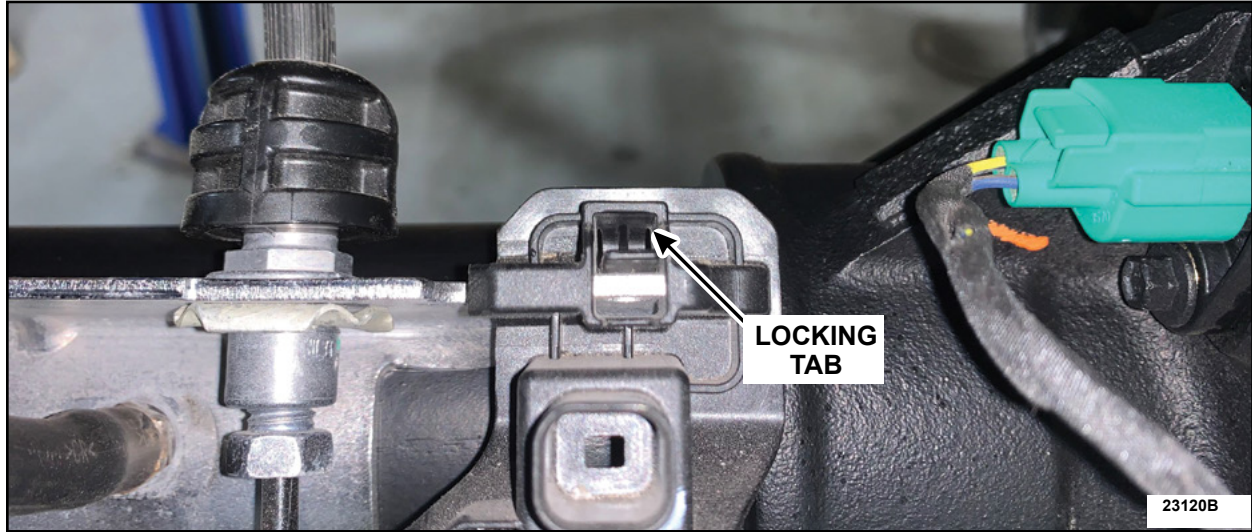

FIGURE 3

4. Lift and hold the locking tab up to disengage. See Figure 4.

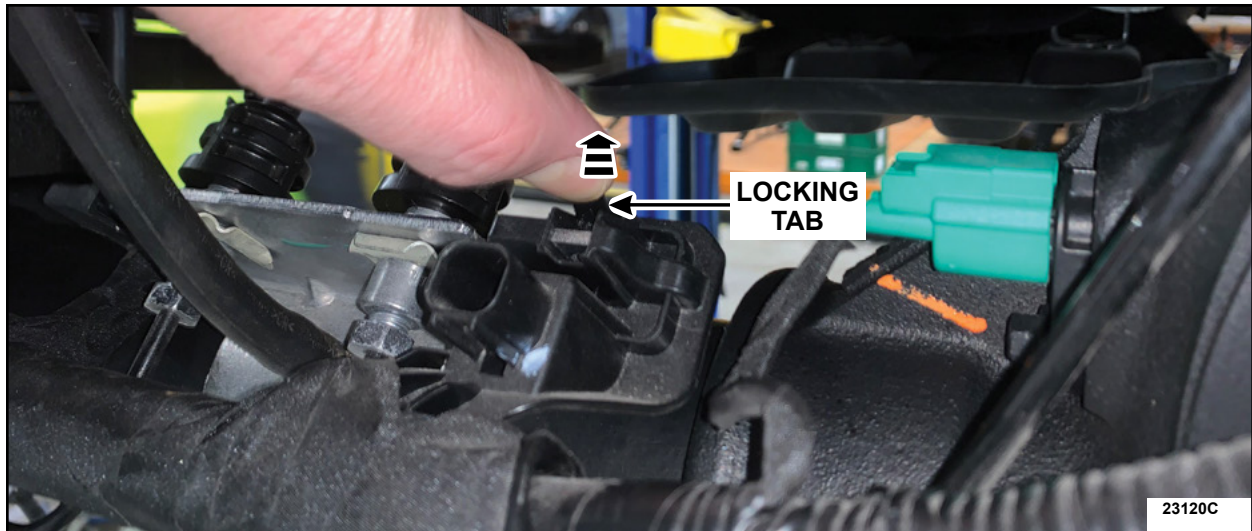

FIGURE 4



5. Remove the inboard end of the shield from the metal bracket. See Figure 5.

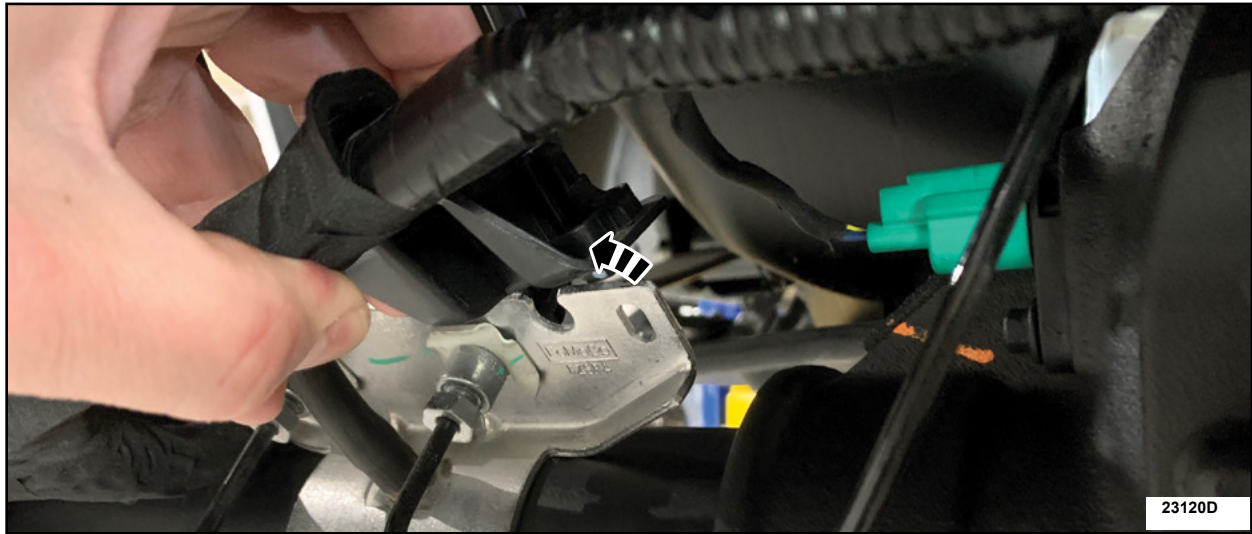

FIGURE 5

6. Slide the shield outboard to complete removal from the metal bracket. See Figure 6.



FIGURE 6



7. Clean dust, dirt, and debris from wire harness before applying the zip-tie and polyken tape.
8. Is the rear wheel speed wire harness tape near the contact location worn completely through to the harness? See Figure 7.

YES - Following the provided instructions in the wire repair kit, repair the harness as needed, then proceed to Step 9.
NO - Proceed to Step 9.

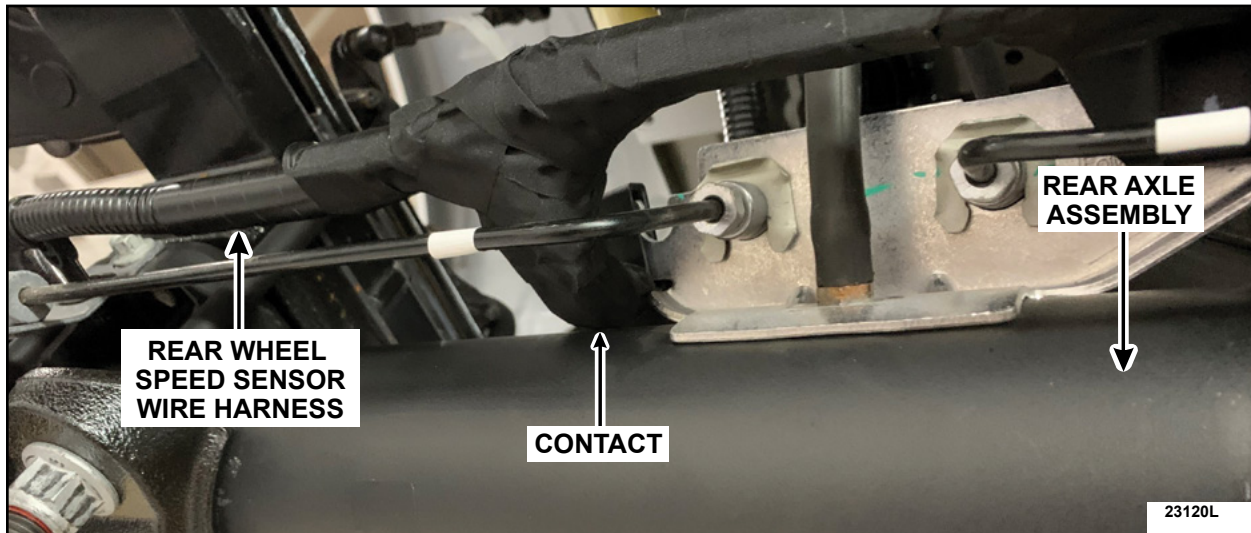

FIGURE 7

9. Anchor spot tape to bundle with two wraps near the tab and let the tape roll hang. See Figure 8.



FIGURE 8



10. Place and tighten the zip tie as close as possible to the cupped attachment feature on the shield.
See Figure 9.

NOTE: The head of the zip tie will overlap the edge on the shield that is under the tape in the harness.

NOTE: This zip-tie is used for extra anti-abrasion between the axle and wire harness and not to be captured to any other components.

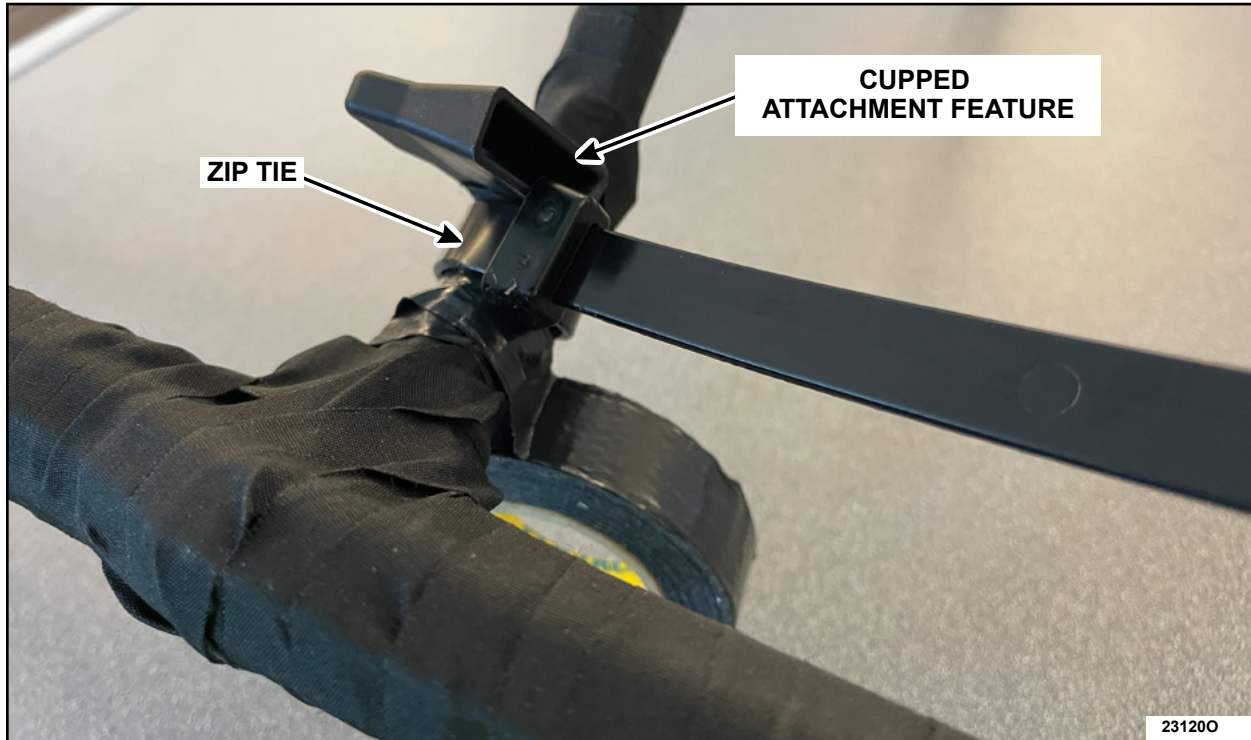

FIGURE 9

11. Using a pair of pliers, pull to a tension where the zip tie will not slide along the bundle. See Figure 10.



FIGURE 10



12. Pull the takeout harness rearward and apply Polyken 650 tape 3/4 width at the forward edge of the zip tie. Anchor tape to wire harness with two loops of tape, then apply four or more wraps of tape, making sure to overlap half of the zip tie. See Figure 11.

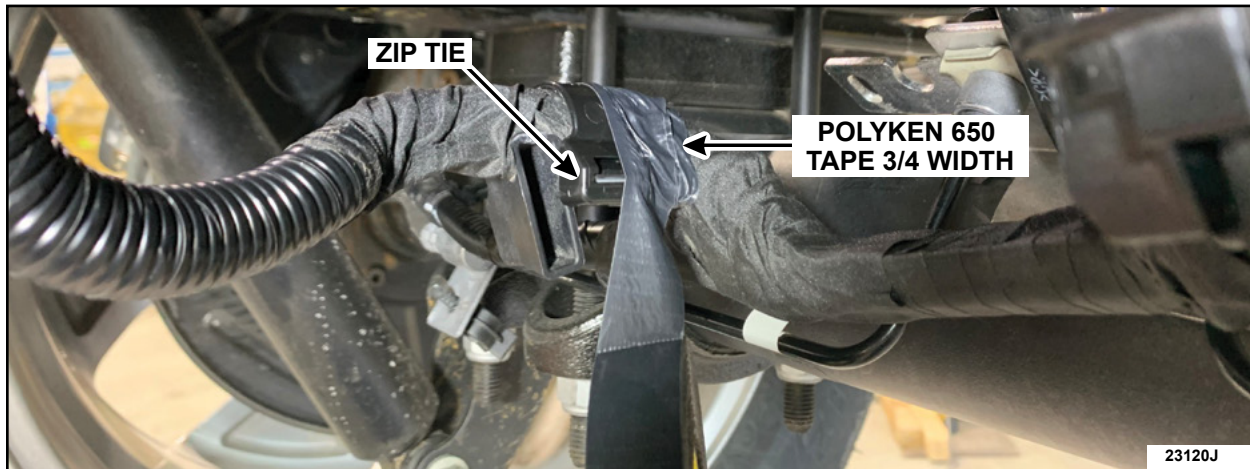

FIGURE 11

13. Reassemble the vehicle by reversing the repair procedure.
14. Clear all DTCs from the vehicle.

IMPORTANT NOTE: Federal law prohibits selling motor vehicle parts or components that are under safety, compliance, or emissions recall. Unless a part is requested to be returned to Ford, all parts replaced under this FSA must be scrapped in accordance with all applicable local, state and federal environmental protection and hazardous material regulations. Refer to the Parts Retention, Return, & Scrapping section of the FSA dealer bulletin for further information.



Recall 23S35













Mobile Service Repair Assessment

Assessment levels have been identified to help determine the ease of performing eligible mobile service repairs for a Field Service Action (FSA) outside of the dealership service facility.

Dealer Bulletin

Within Attachment I of the dealer bulletin a mobile service repair assessment level(s) will be provided. These assessment levels have been determined using the amount of time, equipment and labor identified to perform the intended service action.



Assessment Levels

-  - Mobile Reprogramming
-   - Light Mobile Service
-    - Enhanced Mobile Service
-     - Advanced Mobile Service
-  - Wheel and Tire Mobile Service
-  - Not a Mobile Service Repair

Description of each level that is used to determine the overall assessment.

-  – Mobile Reprogramming
 - Module Programming or similar type services
 - Minimum tools maybe required other than an **IDS/FDRS** setup
 - FDRS programming that requires internet connection (wi-fi or mobile hotspot)
 - Make sure vehicle has a charge port to ensure battery voltage is maintained during flashing of the module(s)
 - Repairs not greater than 1 hour in length (including time to wait for programming)

Note: The location will need a charging station or wall box to maintain the 12-volt battery.

-   – Light Mobile Service
 - Interior repair procedures that do not require seat, dash, or headliner removal
 - Under hood repairs that do not require large component removal
 - Exterior repairs that do not require large component/panel removal
 - Repairs may require standard hand tools (Access to a Technician starter kit or similar)

Recall 23S35

   – Enhanced Mobile Service

- ***A two-person process is required anytime a procedure requires work under the vehicle***
 - Brake Inspection and Brake Repair/Replacement
 - Limited Suspension Component replacement (no alignment)
 - Under Vehicle access for limited repairs (no large component removal)
 - Vehicle Check Up - VCU
 - Pre-Delivery Inspection - PDI
 - Used Car Inspection/Presale Inspection
 - May require floor jack, jack stands, and impact tools
- Note: Wheel lock may be required.*

    – Advanced Mobile Service

- Fluid Exchange/Oil Change
- Light Repairs
- Brake Hydraulic Repairs

 – Wheel and Tire Mobile Service

- Tire Removal from Wheel
- Tire Balancing
- Tire Repair

Note: Specialized Mobile Service unit and equipment including Tire balancer and Tire Changer required.

 – Not a Mobile Service Repair

- Large component removal
- BEV Battery Replacement
- Requires a vehicle hoist – to complete the repair (more than inspection)
- Required vehicle alignment
- Requires significant vehicle disassembly
- Repairs greater than 2-3 hours
- Any repairs that require M-Time
- Includes a service procedure where the vehicle owner may be distressed about the state of their vehicle

23S35

VEHICLE PICK-UP AND DELIVERY RECORD

VIN _____ received (check one):

Pick-up and/or delivery service

As outlined below for the 23S35 Field Service Action program.

Pick-up – Date: _____

Delivery – Date: _____

Repair Order #

Repair Order Date

Service Manager Signature

Date

Ford Motor Company
Recall Reimbursement Plan for 23S35

Ford and Lincoln dealers are in the best position to quickly and efficiently process reimbursement requests. However, federal legislation requires all motor vehicle manufacturers to establish processes through which customers may seek recall reimbursement directly from the manufacturer or the dealers.

Regarding the specific reimbursement plan for Recall # 23S35, owners who have paid for service to remedy the defect or noncompliance must have had that service performed before September 11, 2024. After this date, if repairs related to this recall are performed by a non-Ford repair facility in an emergency, customers must submit any refund requests through their dealership. As required by this federal regulation, Ford Motor Company submitted the details of its latest General Recall Reimbursement Plan in a letter to the National Highway Traffic Safety Administration (NHTSA) in May 2021. The following is the text of that letter and the Plan:

General Recall Reimbursement Plan
(As submitted to the NHTSA)

Pursuant to the requirements set forth in 49 CFR Part 573 and Part 577 of the Code of Federal Regulations, Ford Motor Company (Ford) is submitting required information pertaining to our general reimbursement plan for the cost of remedies paid for by vehicle owners before they are notified of a related safety recall.

Set forth below is Ford's general plan to reimburse owners and purchasers for costs incurred for remedies in advance of notification of potential safety-related defects or noncompliances pursuant to Part 573.6 (c)(8)(i). This plan has not changed since our May 5, 2021 submission.

Reimbursement Notification

Ford's notice to a vehicle owner in accordance with 49 CFR Part 577 will indicate that Ford is offering a refund if the owner paid to have service to remedy the defect or noncompliance prior to a specified ending date. In accordance with Part 573.13 (c)(2), this ending date will be defined as a minimum of ten calendar days after the date on which Ford mailed the last of its Part 577 notifications to owners and will be indicated in the specific reimbursement plan available to owners for an individual recall. This notice will direct owners to seek eligible reimbursement through authorized dealers or, at their option, directly through Ford at the following address:

Ford Motor Company
P.O. Box 6251
Dearborn, MI 48121-6251

Ford notes that this rule allows for the identification of a beginning date for reimbursement eligibility. Under the rule, an owner who paid to remedy the defect or noncompliance prior to the identified beginning date would not be eligible for reimbursement. Ford generally has not established such a beginning date for reimbursement eligibility and does not presently anticipate changing this general policy. However, in any case where Ford determines a beginning date is appropriate, Ford will indicate that date in the owner notice. As permitted by 577.11(e), Ford may not include a reimbursement notification when all vehicles are well within the warranty period, subject to approval by the Agency.

Costs to be Reimbursed

For vehicles, reimbursement will not be less than the lesser of:

- The amount paid by the owner for the remedy that specifically addressed and was reasonably necessary to correct the defect or noncompliance that is the subject of the recall, or
- The cost of parts for the remedy (to be no more than the manufacturer's list retail price for authorized part(s), plus associated labor at local labor rates, miscellaneous fees (such as disposal of waste) and taxes.

For replacement equipment, reimbursement will be the amount paid by the owner for the replacement item (limited by the amount of the retail list price of the defective or noncompliant item that was replaced, plus taxes, where the brand or model purchased by the owner was different than the brand or model that was the subject of the recall). If the item of motor vehicle equipment was repaired, the reimbursement provisions identified above for vehicles will apply.

Ford notes that costs incurred by the owner within the period during which Ford's original or extended warranty would have provided for a free repair of the problem will not be eligible for reimbursement, as provided by Part 573.13 (d)(1).

Entities Authorized to Provide Reimbursement

Ford will continue to use authorized dealers to reimburse owners under the specific reimbursement plans for a particular recall and will encourage owners to pursue requests for reimbursement directly through dealers to expedite reimbursement. Ford will also provide a mailing address to which customers can, at their option, send requests for reimbursement directly to Ford, as previously noted. Requests for reimbursement sent directly to Ford may take up to 60 days to process. Whether the owner chooses to pursue reimbursement requests through a dealer or directly through Ford, the owner will be directed to submit the required documentation, upon which reimbursement eligibility will be determined.

Required Documentation

The reimbursement determination will depend upon the information provided by the customer. Consistent with Part 573.13 (d)(4) the following information must be submitted:

- Claimant name and address
- Vehicle make, model and model year
- Vehicle identification number (VIN) and, for replacement equipment, a description of such equipment or, for tires, the model, size and TIN (DOT code)
- Identification of the recall number (either the Ford recall number or the NHTSA recall number)
- Identification of the owner of the recalled vehicle at the time that the pre-notification remedy was obtained
- An original receipt for the pre-notification remedy that includes a breakdown of the amount for parts, labor, other costs and taxes, including costs for the replacement item. Where the receipt covers work other than to address the recall or noncompliance, Ford may require the claimant to separately identify costs that are eligible for reimbursement.
- If the remedy was obtained during the warranty repair did not correct the problem related to the recall

Failure to submit all the above information may result in denial of the reimbursement request.

Additional Information

The Part 577 required owner notice will provide a toll-free telephone number through which specific information about the reimbursement plan can be requested from Ford. This general reimbursement plan will be incorporated into notifications pursuant to Part 573.6 by reference. Information specific to an individual recall also may be incorporated into the Part 573.6 notification.

Interim Repair Statement

Safety Recall 23S35

Your vehicle was inspected and found to have damage to the rear axle wire harness. As an interim repair, we have repaired the physical damage to the wires. When parts become available, Ford Motor Company will notify you to schedule an appointment with your dealer to receive a permanent repair.