



Stacy L. Balzer
 Director
 Service Engineering Operations
 Ford Customer Service Division

Ford Motor Company
 PO Box 1904
 Dearborn, Michigan 48121

June 11, 2024

TO: All U.S. Ford and Lincoln Dealers

SUBJECT: NEW VEHICLE DEMONSTRATION / DELIVERY HOLD - Safety Recall 23S33
 Certain 2019-2020 Model Year Fusion Energi PHEV vehicles -
Battery Fuse Block Installation

REF: NEW VEHICLE DEMONSTRATION / DELIVERY HOLD - Advance Notice –
Safety Recall 23S33
 Dated June 27, 2023

New! REASON FOR THIS BULLETIN

- *An interim repair is now available.*
- *Ford is now offering an alternative remedy option for vehicles affected by this recall in the form of a statutory vehicle refund pursuant to Title 49 U.S. Code § 30120(a)(1)(A)(iii).*
- *Owner Refund terms have been modified to define when 23S33 will stay active on the vehicle.*
- *Rental Vehicle terms have been modified to account for the statutory refund process.*

AFFECTED VEHICLES

| Vehicle | Model Year | Assembly Plant | Build Dates |
|---------------|------------|----------------|--|
| Fusion Energi | 2019-2020 | Hermosillo | December 6, 2017 through July 27, 2020 |

US population of affected vehicles: 14,645. Affected vehicles are identified in OASIS and FSA VIN Lists.

REASON FOR THIS SAFETY RECALL

In the affected vehicles, Current Interrupt Device (CID) activation in a high voltage battery cell can result in excess voltage and current flow through the Battery Energy Control Module (BECM), which can cause damage to the BECM. Excess voltage and current flow through the BECM can result in a loss of motive power which increases the risk of a crash, or a vehicle fire in the trunk area which increases the risk of injury.

SERVICE ACTION

DO NOT DEMONSTRATE OR DELIVER any new in-stock vehicles involved in this safety recall. As an interim repair, dealers are to install a BECM fuse block and update the Powertrain Control Module (PCM) and associated modules software. This service must be performed on all affected vehicles at no charge to the vehicle owner.

This interim repair will perform two actions.

1. It will install a fuse block between the high voltage battery and the BECM. This will remove the possibility of an internal high voltage battery failure generating a hot spot in the BECM that could lead to a fire in the luggage compartment.
2. This repair will disable the plug-in charging feature of your vehicle via a software update. If the vehicle is plugged into a high voltage charger the battery will not charge. **The vehicle will continue to operate as a non-plug-in hybrid vehicle.** When a complete repair is released the software update will be reversed and plug-in vehicle charging will be enabled again.

For new vehicle storage guidelines, refer to EFC13033, Storage Guidelines for New Vehicles.

To assist vehicle owners to have this repair completed when parts are available, dealers should:

- Arrange to pick up the owner's vehicle and drive it to the dealership for repairs (rentals are authorized – see Rental Vehicles) and re-deliver the owner's vehicle after repairs have been completed.
- Pick-Up & Delivery, (towing, alternative transportation,) and mobile service should be made available for all customers. Refer to the Rental and Claiming sections for further details.

New. INTERIM REPAIR

Ford is now offering an interim repair, both hardware and software, that will disable external charging yet allow the vehicle to operate like a non-plug-in hybrid. This repair is available to all customers who are waiting for the permanent battery solution.

New. STATUTORY VEHICLE REFUND OPTION

Ford is now offering an alternative remedy option for vehicles affected by this recall. Ford is offering customers a statutory refund of the vehicle's purchase price, less a reasonable allowance for depreciation. The "refund amount" is based on fair market value of the vehicle, plus a 15% premium. "Fair market value" is based on the original Manufacturer's Suggested Retail Price (MSRP), less depreciation as determined using regional market data, and does not include the cost of any modifications made to the vehicle after the first retail sale.

This alternative remedy will be offered until July 30, 2025, when sufficient quantities of high voltage batteries are expected to be available for final remedy repairs.

For details on the statutory refund, customers and dealers can visit www.Ford.com/Recall23S33 to access the Vehicle Refund Estimator and Terms & Conditions.

Customers must contact the Ford Customer Relationship Center (CRC) at 1-833-807-3673 before July 1, 2025 to lock in their official statutory refund amount and to proceed with the refund process.

Dealers should expect an increase in re-acquired vehicle processing, however vehicle inspections will not be carried out as part of this program. If a customer chooses the statutory refund option, the recall will be closed after the completion of the refund process.

New. OWNER NOTIFICATION MAILING SCHEDULE

To prevent delays in processing refunds, this will be a phased mailing and owners of affected vehicles will be notified in two separate mailings. The mailings will occur the week of June 17, 2024 and July 8, 2024. Customers can request a statutory vehicle refund, whether or not the customer has received a letter.

PLEASE NOTE:

Federal law requires dealers to complete this recall service before a new vehicle is delivered to the buyer or lessee. Violation of this requirement by a dealer could result in a civil penalty of up to \$27,168 per vehicle. Correct all vehicles in your new vehicle inventory before delivery.

ATTACHMENTS

- Administrative Information
- Labor Allowances and Parts Ordering Information
- Technical Instructions
- Mobile Service Repair Assessment
- Mobile Repair/Vehicle Pick-Up & Delivery Record
- Owner Notification Letters
- Recall Reimbursement Plan

QUESTIONS & ASSISTANCE

For questions and assistance, contact the Special Service Support Center (SSSC) via the SSSC Web Contact Site. The SSSC Web Contact Site can be accessed through the Professional Technician System (PTS) website using the SSSC link listed at the bottom of the OASIS VIN report screen or listed under the SSSC tab.

Sincerely,



Stacy L. Balzer

Safety Recall 23S33**MOBILE SERVICE REPAIR ASSESSMENT LEVEL**

 - Not a Mobile Service Repair

OASIS ACTIVATION

OASIS was activated on June 27, 2023.

FSA VIN LISTS ACTIVATION

FSA VIN Lists are available through <https://web.fsavinlists.dealerconnection.com>. Owner names and addresses were available on August 4, 2023.

NOTE: Your FSA VIN Lists may contain owner names and addresses obtained from motor vehicle registration records. The use of such motor vehicle registration data for any purpose other than in connection with this recall is a violation of law in several states, provinces, and countries. Accordingly, you must limit the use of this listing to the follow-up necessary to complete this recall.

SOLD VEHICLES

- Ford has not issued instructions to stop selling/delivering or driving used vehicles under this safety recall. Owners should contact their dealers for an appointment to have their vehicles remedied as soon as practicable.
- Immediately contact any of your affected customers whose vehicles are not on your VIN list but are identified in OASIS. Give the customer a copy of the Owner Notification Letter (when available) and schedule a service date.
- Correct other affected vehicles identified in OASIS which are brought to your dealership.
- Dealers are to prioritize repairs of customer vehicles over repairs of new and used vehicle inventory.

STOCK VEHICLES

- Correct all affected units in your new vehicle inventory before delivery.
- Use OASIS to identify any affected vehicles in your used vehicle inventory.

DEALER-OPERATED RENTAL VEHICLES

The Fixing America's Surface Transportation (FAST) Act law effective June 2016 prohibits a rental company from selling, renting, or leasing vehicles subject to a safety or compliance recall. Please consult your legal counsel for legal advice.

BRANDED / SALVAGED TITLE VEHICLES

Affected branded / salvaged title vehicles are eligible for this recall.

Safety Recall 23S33**New! OWNER REFUNDS FOR REPAIRS**

- **This safety recall must still be performed, even if the owner has paid for a previous repair. Claiming a refund for repairs will not close the recall on the vehicle.**
- Ford Motor Company is offering a refund for owner-paid repairs covered by this recall if the repair was performed before the date indicated in the reimbursement plan, which is posted with this bulletin. Owners are directed to seek reimbursement through authorized dealers or, at their option, directly through Ford Motor Company at PO Box 6251, Dearborn, MI 48121-6251.
- Dealers are also pre-approved to refund owner-paid emergency repairs that were performed away from an authorized servicing dealer after the end date specified in the reimbursement plan. Non-covered repairs, or those judged by Ford to be excessive, will not be reimbursed.
- *When a customer claims a refund for a prior repair, Recall 23S33 will stay open on their vehicle.*
- *When a customer claims a refund for the statutory vehicle refund, Recall 23S33 will be closed on their VIN in OASIS after the refund process has completed.*
- Refunds will only be provided for the cost associated with high voltage battery replacement.

New! RENTAL VEHICLES

- Ford has not issued instructions to stop driving vehicles under this safety recall.
- If the CID has activated and the customer requests a rental vehicle, you may submit a request to the SSSC under FSA **23S33** using contact-type APPROVAL REQUEST for consideration. Follow Extended Service Plan (ESP) guidelines for dollar amounts.
 - *Customers whose vehicles have activated the CID and are working with the CRC to process a statutory refund are eligible for a rental vehicle until the refund process has completed.*

TOWING

If towing is required, dealers are authorized to claim up to a maximum value of \$250 to provide towing services for this program.

PICK-UP & DELIVERY- Participating Dealers

Dealers participating in the Remote Experience Program:

- Ford Dealers - Refer to EFC14125, 2024 Remote Experience Program, Pick-Up & Delivery Offset section for additional details.

PICK-UP & DELIVERY- Non-participating Dealers

Ford Dealers not participating in the 2024 Remote Experience Program for Pick-Up & Delivery are authorized to claim unique services for completing this program.

- Dealers are authorized to claim one-half labor hour per repair for vehicle Pick-Up & Delivery services. Refer to Labor Allowances for details.
- Dealers must retain a Vehicle Pick-Up & Delivery Record with the repair order documentation.

Safety Recall 23S33

ALTERNATIVE TRANSPORTATION

If a customer is unable or does not wish to rent a vehicle but still requires transportation, the rental reimbursement allowance can be used for alternative transportation. Alternative transportation is approved for \$100 per day for both Ford and Lincoln customers. The dollar-per-day allowance can be cumulative across multiple rides per day (e.g. ride to work \$20 and ride home \$24).

- Alternative transportation reimbursement can be claimed for both short-term and long-term scenarios.
- Any amount over the cost-per-day limits will be the customer's responsibility.
- The customer will need to pay upfront and provide proof of payment to the dealer.
- Dealers will then need to submit for reimbursement following the Rental Vehicle Reimbursement Process and then refund the customer.

Examples of alternative transportation:

- Taxi
- Public Transportation - Subway, Train, or Bus
- Rideshare alternatives (Uber, Lyft, etc.)

ADDITIONAL REPAIR (LABOR TIME AND/OR PARTS)

Additional repairs identified as necessary to complete the FSA should be managed as follows:

- For related damage and access time requirements, refer to the Warranty and Policy Manual / Section 6 – Ford & Lincoln Program Policies / General Information & Special Circumstances for FSAs / Related Damage.
- For vehicles within new vehicle bumper-to-bumper warranty coverage, no SSSC approval is required, although related damage must be on a separate repair line with the "Related Damage" radio button checked.
 - Ford vehicles – 3 years or 36,000 miles
- For vehicles outside new vehicle bumper-to-bumper warranty coverage, submit an Approval Request to the SSSC Web Contact Site before completing the repair.

CLAIMS PREPARATION AND SUBMISSION

- **Technician Competency Requirement:** The STST Competency 10 certification requirement in the U.S. market only will be enforced starting with repair orders opened on or after April 1, 2024. FSA repairs will reject if the repairing technician is not certified in STST Competency 10 FSA. See EFC14251 for more details.
- **Claim Entry:** Enter claims using Dealer Management System (DMS) or One Warranty Solution (OWS) online.
 - When entering claims, select claim type 31: Field Service Action. The FSA number 23S33 is the subcode.
 - For additional claims preparation and submission information, refer to the Recall and Customer Satisfaction Program (CSP) Repairs in the OWS User Guide.
- **Related Damage/Additional labor and/or parts:** Must be claimed as Related Damage on a separate repair line from the FSA with the same claim type and subcode as described in Claim Entry above.

IMPORTANT: Click the Related Damage Indicator radio button.

Safety Recall 23S33

CLAIMS PREPARATION AND SUBMISSION (Continued)

- **Rentals:** For rental vehicle claiming, follow Extended Service Plan (ESP) guidelines for dollar amounts. Enter the total amount of the rental expense under the Miscellaneous Expense code RENTAL.
- **Refunds:** Submit refunds on a separate repair line.
 - Program Code: 23S33 - Misc. Expense: ADMIN
 - Misc. Expense: REFUND - Misc. Expense: 0.2 Hrs.
 - Multiple refunds should be submitted on one repair line and the invoice details for each repair should be detailed in the comments section of the claim.
- **Pick-Up & Delivery:**
 - Dealers participating in the Remote Experience Program –
 - Refer to EFC14125, 2024 Remote Experience Program, Pick-Up & Delivery (PDL) Offset section for additional details.
 - Dealers NOT participating in the Remote Experience Program –
 - Dealers may claim one-half labor hour per repair for vehicle Pick-Up & Delivery services.
 - Dealers must retain a Vehicle Pick-Up & Delivery Record with the repair order documentation.
- **Provision for Locally Obtained Supplies:** Includes zip ties, misc. fasteners, cleaning solvents, etc. Submit on the same line as the repair.
 - Program Code: 23S33
 - Misc. Expense: OTHER
 - Misc. Expense: Claim up to \$20 (\$270 Combined with Towing)
- **Provision for Towing:** Dealers are authorized to claim up to a maximum value of \$250 to provide towing services for completing this program. Submit on the same line as the repair.
 - Program Code: 23S33
 - Misc. Expense: OTHER
 - Misc. Expense: Claim up to \$250.00 (\$270 Combined with Locally Obtained Supplies)

Safety Recall 23S33

LABOR ALLOWANCES

| Description | Labor Operation | Labor Time |
|--|-----------------|------------|
| Install Fuse Block on PHEV battery and related hardware, reprogram the PCM using IDS release 130.05 or higher. NOTE: This is an interim repair and will not close the recall. | 23S33B | 1.5 Hours |
| Vehicle Pick-Up & Delivery Allowance: This allowance is only for <u>non-eligible</u> 2024 Remote Experience Program Dealers. NOTE: This allowance is for dealer-performed vehicle Pick-Up & Delivery for dealership repairs only. Can only be claimed once, regardless of outstanding FSAs repaired. | 23S33PP | 0.5 Hours |

PARTS REQUIREMENTS / ORDERING INFORMATION

| Service Part Number | Claim Quantity | Package Order Quantity | Number in Package | Description |
|---------------------|----------------|------------------------|-------------------|--|
| KG9Z-10D811-A | 1 | 1 | 1 | Fuse Block |
| KG9Z-14A163-A | 1 | 1 | 1 | Installation hardware package |
| JM5Z-10A687-E | 1 | 1 | 1 | BECM Cover |
| GG9Z-10A687-D | 1 | 1 | 1 | High Voltage Fuse Bracket (Finger-proof cover) |

Order your parts through normal order processing channels. To guarantee the shortest delivery time, an emergency order for parts must be placed.

DEALER PRICE

For the latest prices, refer to DOES II.

PARTS RETENTION, RETURN, & SCRAPPING

Follow the provisions of the Warranty and Policy Manual, Section 1 - WARRANTY PARTS RETENTION AND RETURN POLICIES. If a replaced part receives a scrap disposition, the part must be scrapped by all applicable local, state, and federal environmental protection and hazardous material regulations. Federal law prohibits selling motor vehicle parts or components that are under safety, compliance, or emissions recall.

EXCESS STOCK RETURN

The excess stock returned for credit must have been purchased from Ford Customer Service Division by Policy Procedure Bulletin 4000.

Safety Recall 23S33

REPLACED FSA PARTS INSPECTION AND SIGN OFF

Effective March 1st, 2021, all parts replaced as part of an FSA repair with a repair order open date of March 1st, 2021, or later must be inspected and signed off on the repair order by a member of your dealer fixed operations management team or an employee of the task has been delegated to. If the task is to be delegated to a non-management employee, the employee needs to be someone other than the technician who completed the repair and needs to understand the importance of completing this task consistently and accurately.

- All parts replaced as part of an FSA repair should be returned to the parts department following the Warranty Parts Retention and Return Policies.
- Inspect the replaced parts to verify the FSA repair was completed.
- If the FSA repair is found to be complete, the designated employee signs the repair order line or parts return stamp area (electronic or hand signed) for the FSA repair indicating the parts were inspected and validated to have been replaced.
- After the parts have been inspected, they should be handled based on the guidance in the parts status report in the Online Warranty System (Hold, Return, CORE, Scrap, etc.). Please visit FMCDEALER > PARTS & SERVICE > WARRANTY ADMINISTRATION & WARRANTY PARTS RETURN for the latest [Immediate Scrap List](#) information.
- This process is subject to review during warranty audits for FSA repairs with a repair order open date of March 1st, 2021, or later. Any eligible FSA claims requiring parts replacement found not to have been inspected and signed off during a warranty audit will be subject to chargeback and consideration for enrollment into the Dealer Incomplete Recall Repair Process.

Note: Other approvals (electronic or handwritten) for add-on repair lines, dealer-owned vehicle repairs, and repeat repairs do not qualify as FSA parts inspection approvals. The post-repair FSA parts inspection process (electronic or handwritten) is independent of other warranty approval requirements. The approval by the designated employee implies that the FSA parts were found to be replaced and must be able to be identified on the Repair Order. If multiple FSAs require approval on a single Repair Order, each applicable occurrence will require individual post-repair approval by the designated employee.

CERTAIN MODEL YEAR 2019-2020 FUSION PHEV VEHICLES — BATTERY FUSE BLOCK INSTALLATION

SERVICE PROCEDURE

IMPORTANT! The Service Technician Specialty Training (STST) Competency 10 certification requirement, for U.S. market only, will be enforced starting with repair orders opened on or after April 1, 2024. Field Service Action (FSA) repairs will reject if the repairing technician is not certified in STST Competency 10 FSA. See Electronic Field Communication (EFC) 14251 for more details.

IMPORTANT! This Field Service Action (FSA), must be performed by a certified BEV technician.

1. Disconnect the high voltage battery. Follow the WSM procedures in Section 414-03A.
2. Disconnect the 12 volt (V) battery. Follow the WSM procedures in Section 414-01.
3. Remove the rear seat cushion. Follow the WSM procedures in Section 501-10B.
4. Remove the retainers, the loadspace floor cover and the battery cover. See Figure 1.

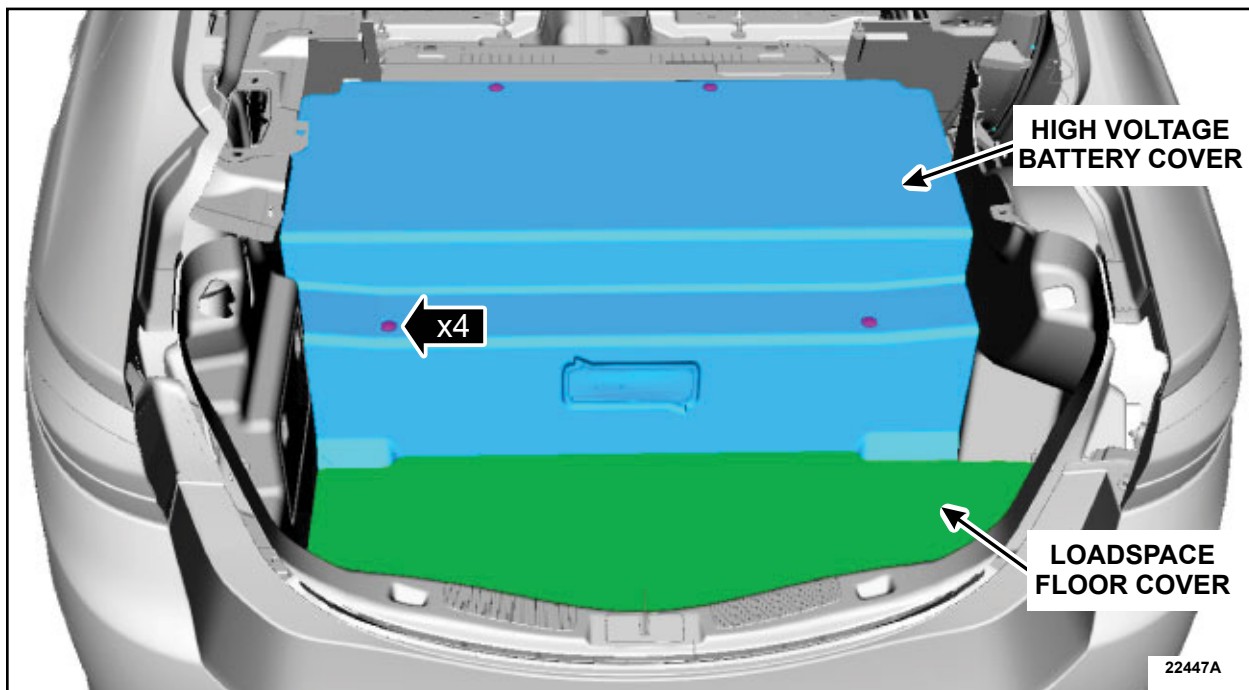

FIGURE 1



5. Remove the high voltage battery bracket. See Figure 2.

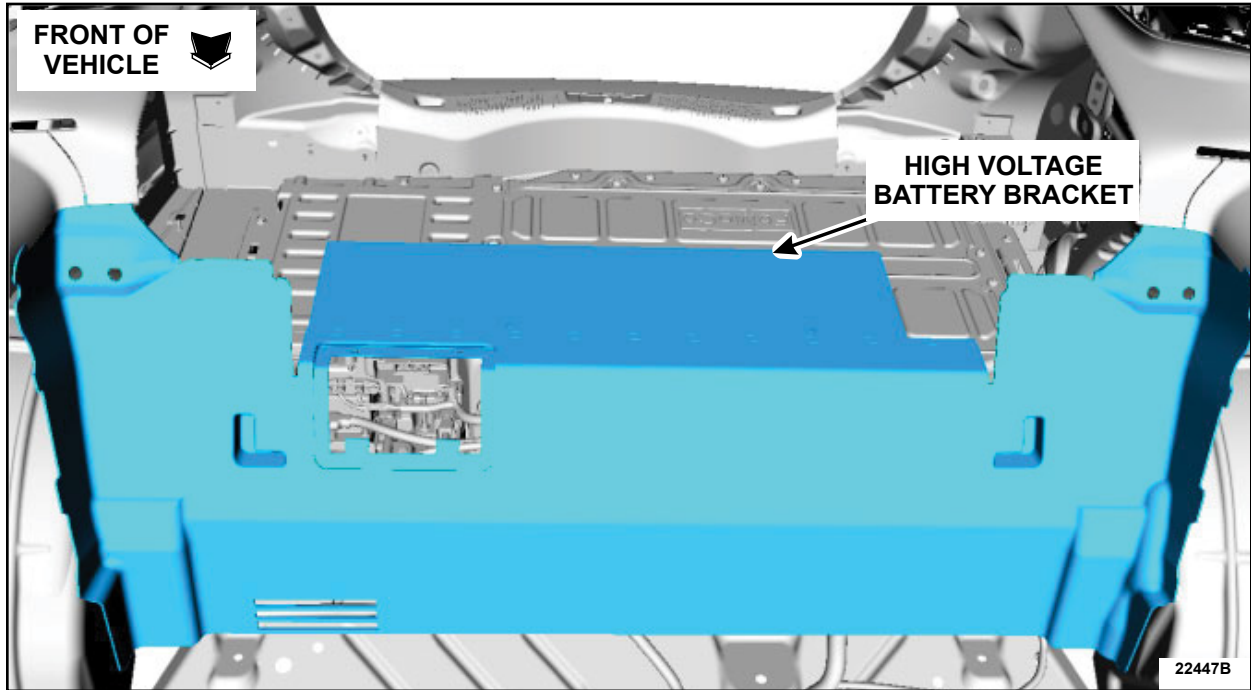

FIGURE 2

6. Remove the retainers and the air duct. See Figure 3.

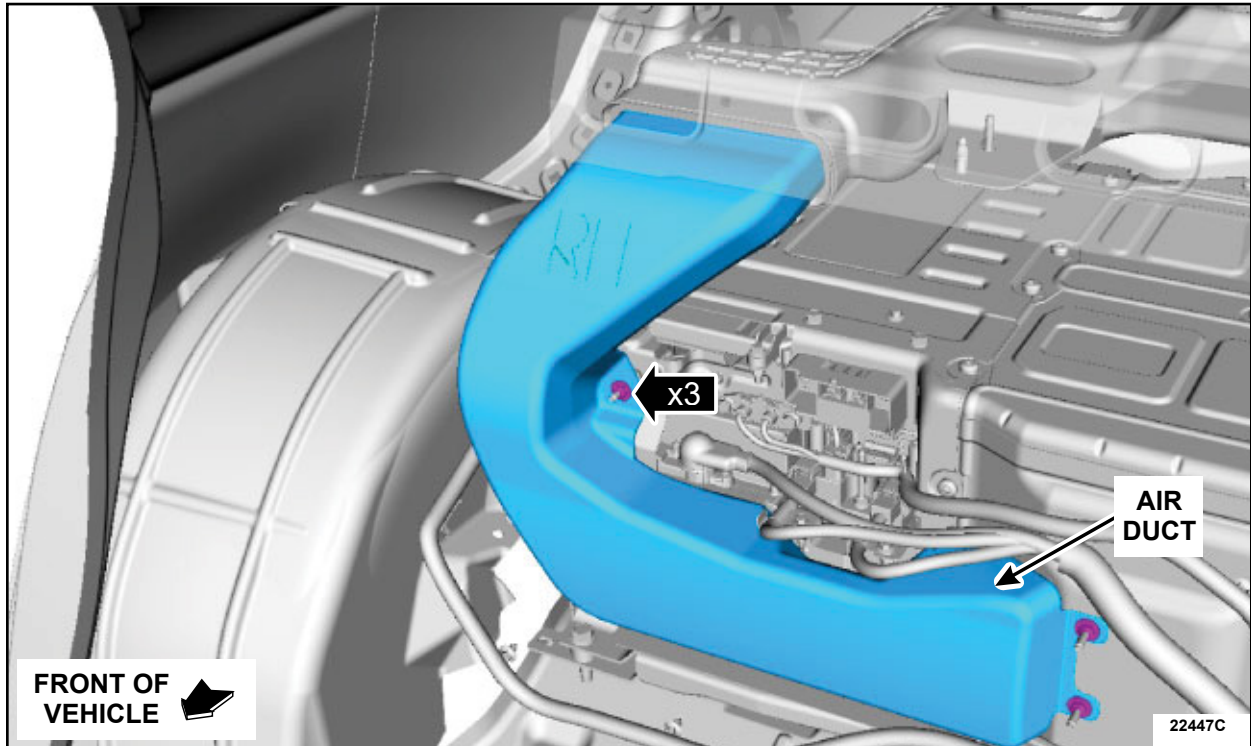

FIGURE 3



7. Remove the retainers and the high voltage battery fuse bracket. See Figure 4.

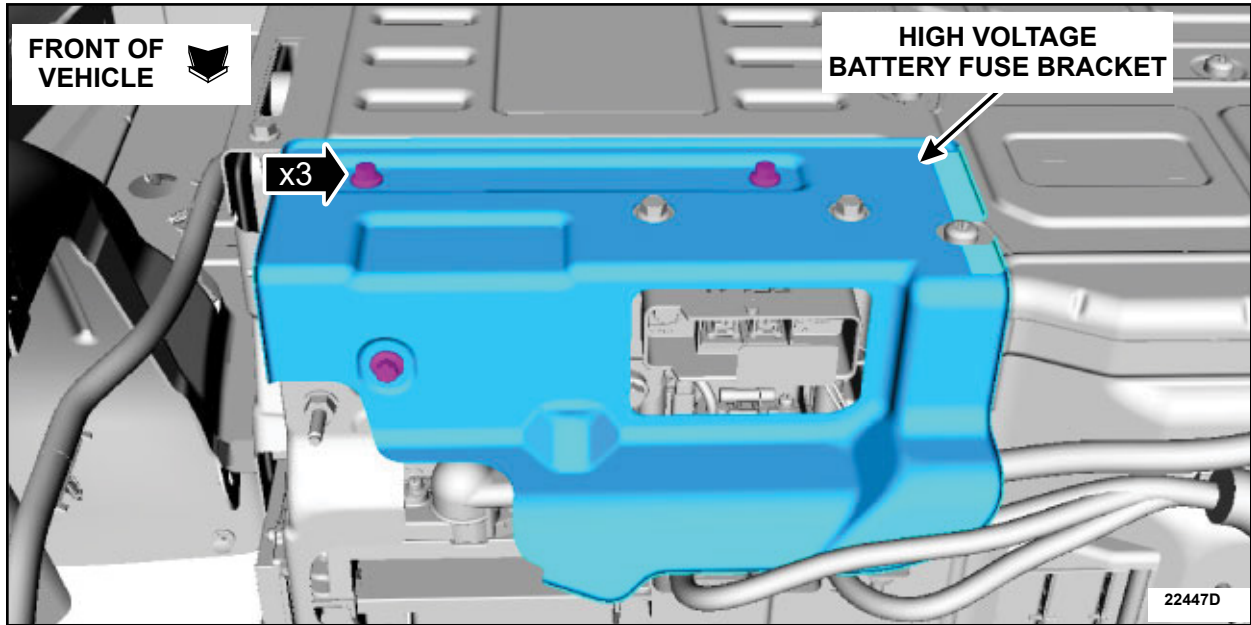

FIGURE 4

8. Loosen the retainers on the passenger side of the high voltage battery cover.. See Figure 5.

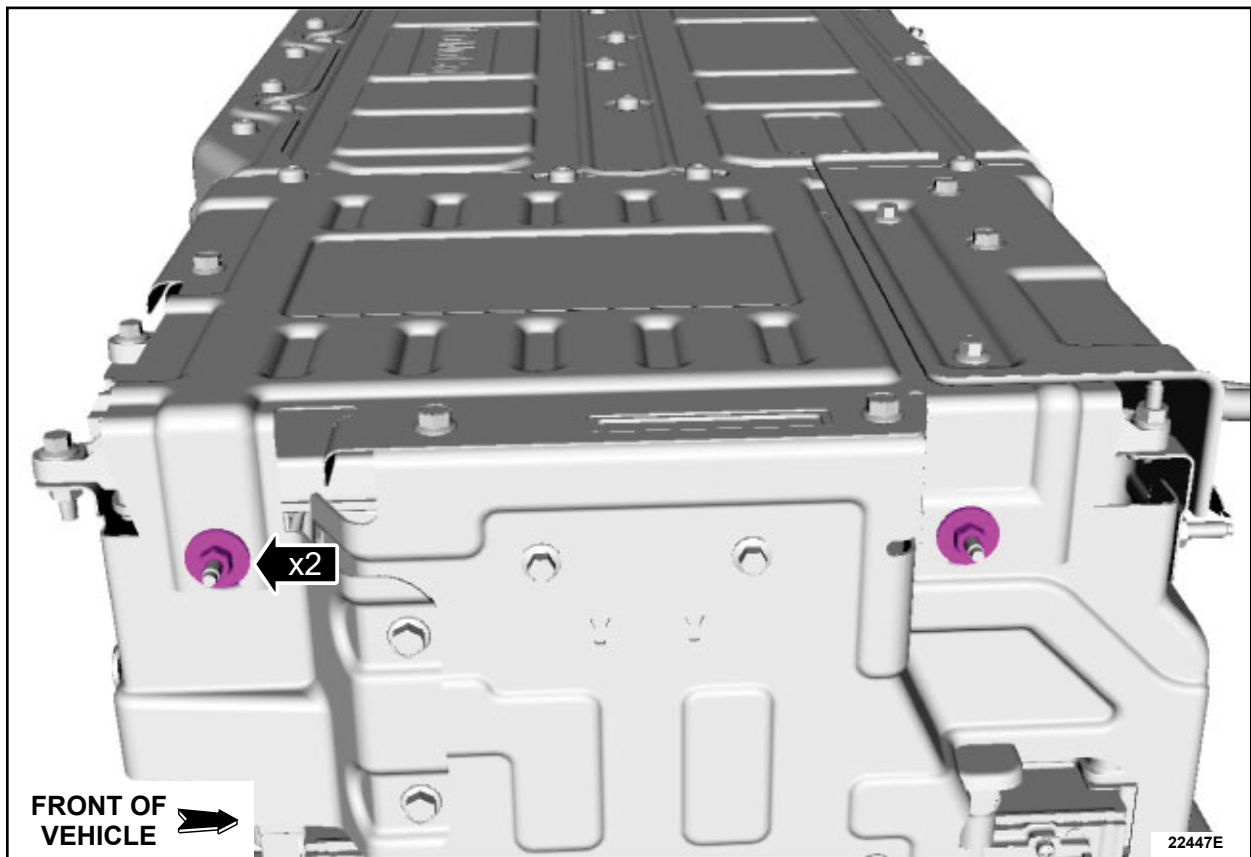

FIGURE 5



9. Remove the retainers and the high voltage battery cover. See Figure 6.
- a. Torx bolts.
 - b. Hex bolts.

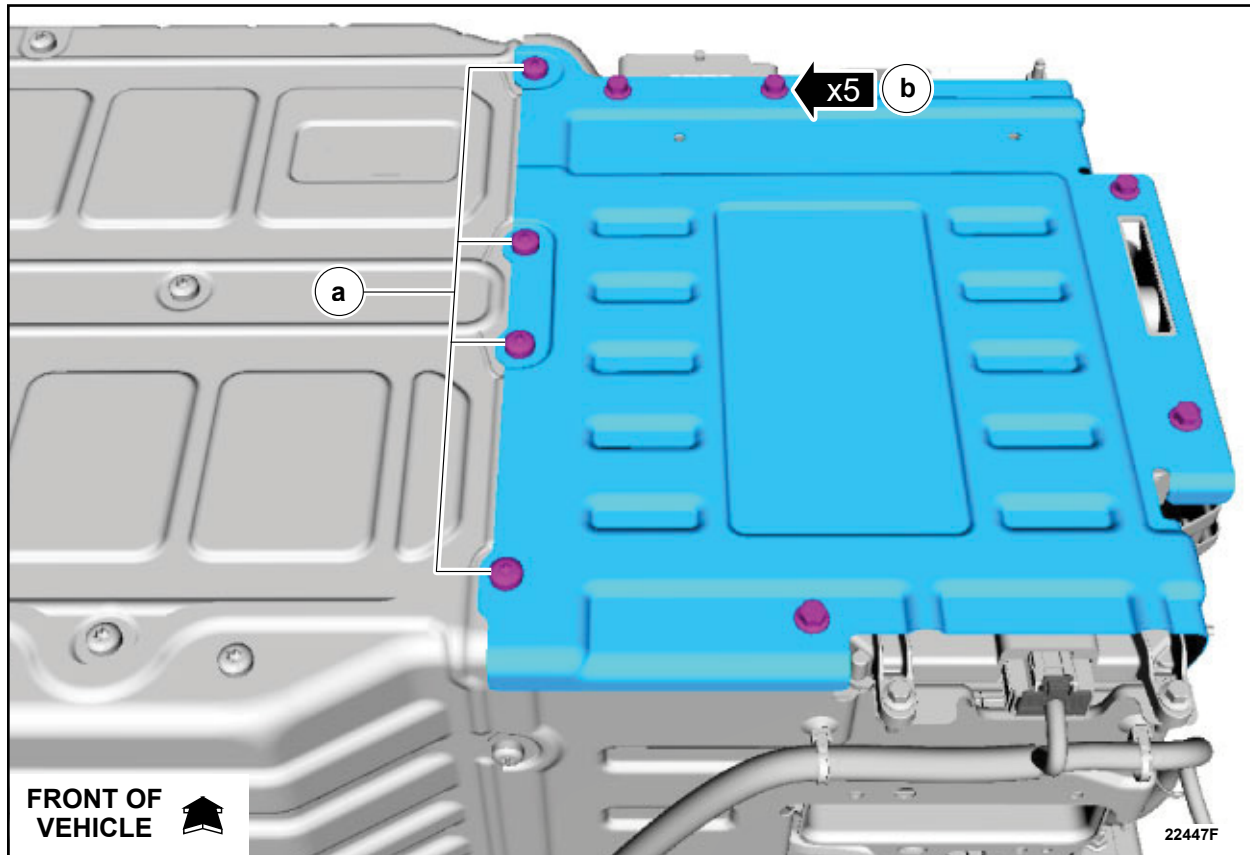

FIGURE 6



10. Remove the Battery Energy Control Module (BECM) retainers. See Figure 7.

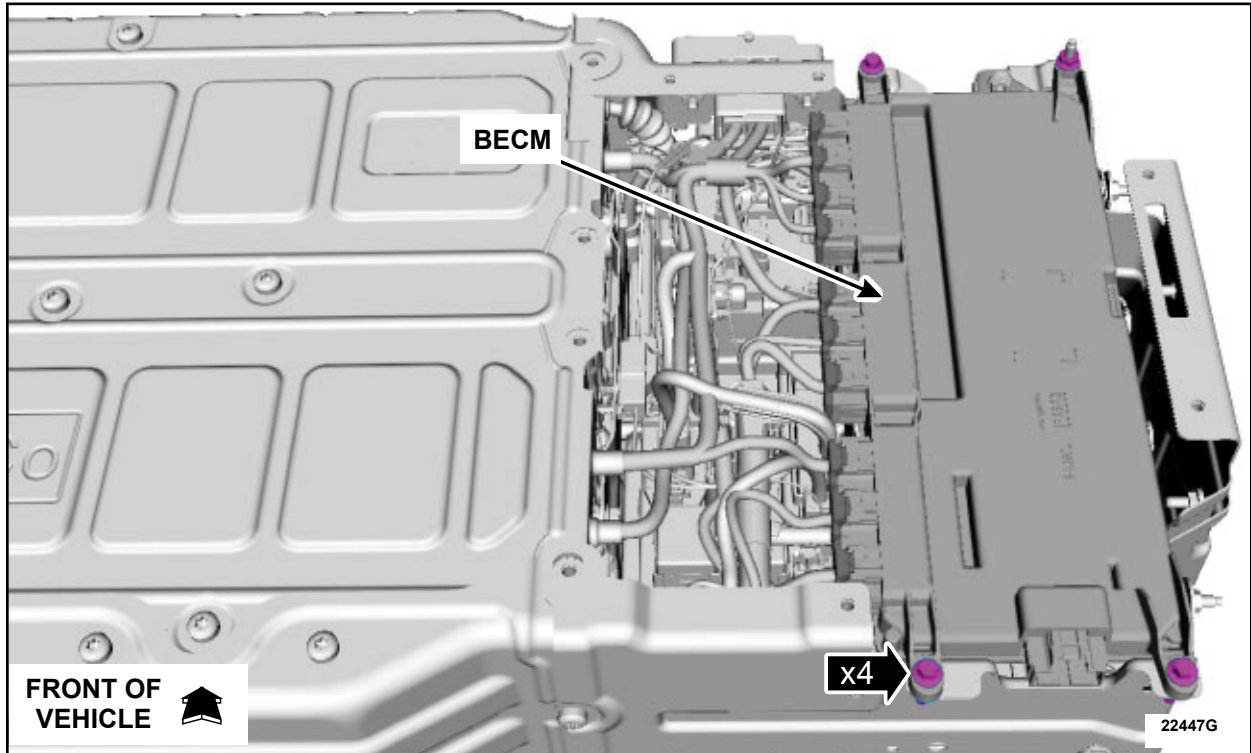

FIGURE 7

11. Position the BECM upwards. See Figure 8.

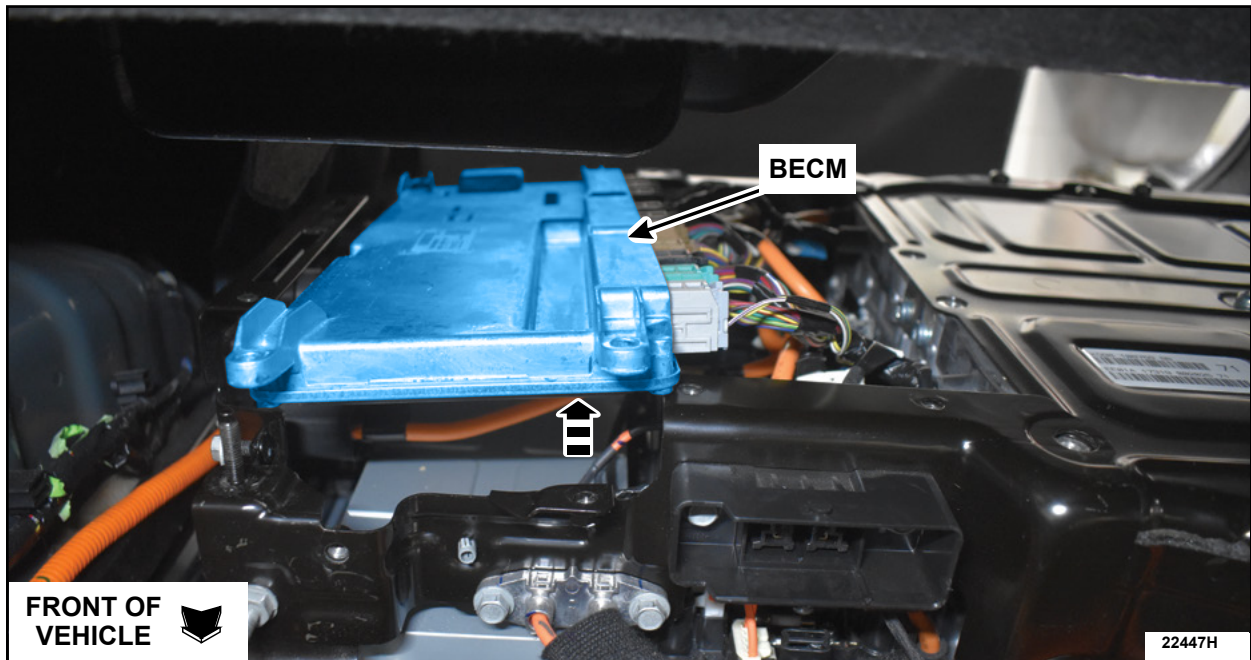

FIGURE 8



12. Disconnect the 7 electrical connectors on the front of the vehicle side of the BECM. See Figure 9.

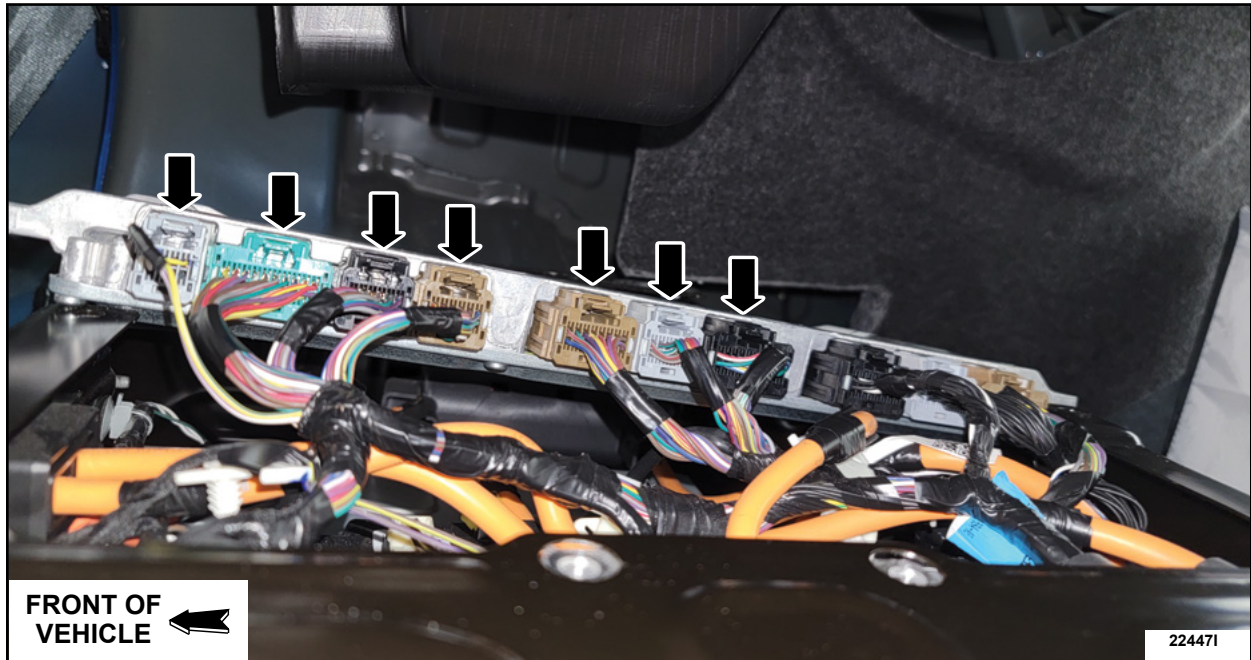

FIGURE 9



Fuse Block Kit Contents

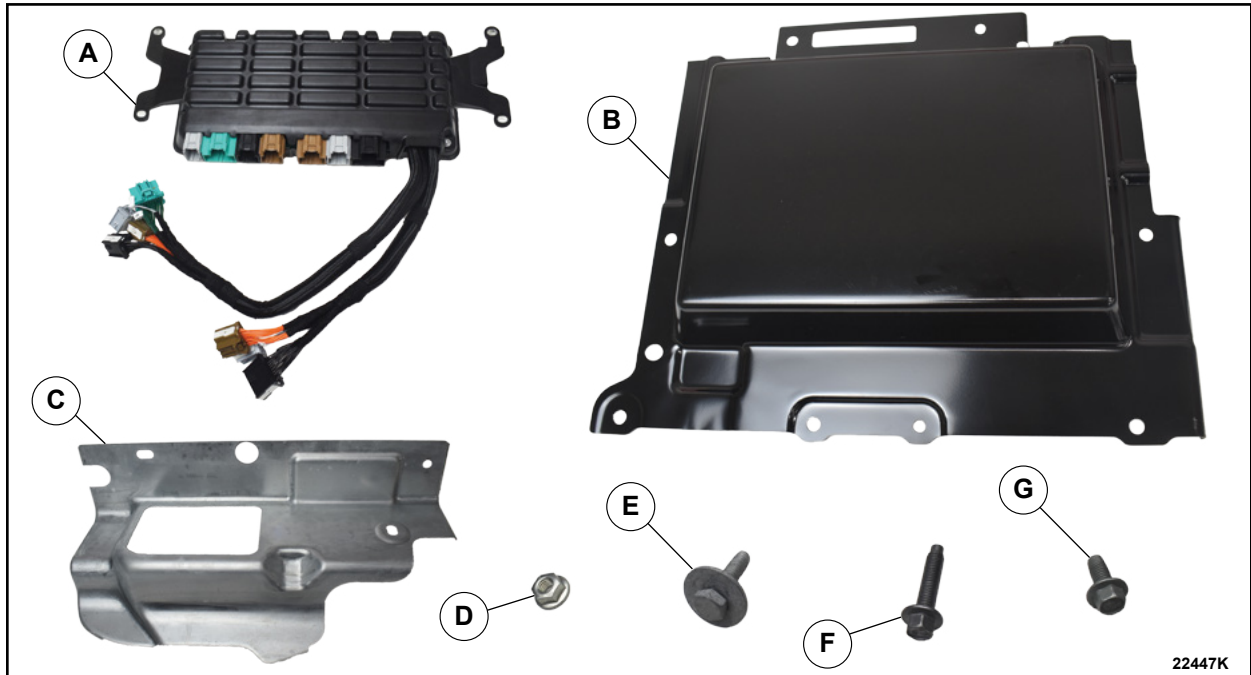

FIGURE 10

| ITEM | DESCRIPTION | QTY |
|------|---|-----|
| A | Fuse Block | 1 |
| B | BECM Cover | 1 |
| C | High Voltage Fuse Bracket (Finger-proof cover) | 1 |
| D | Nut (included in Hardware Package) | 1 |
| E | Bolt with Washer (included in Hardware Package) | 1 |
| F | Long Bolt (included in Hardware Package) | 3 |
| G | Short Bolt (included in Hardware Package) | 2 |



13. Position the fuse block (Item A) on the battery. Connect the 7 connectors from the fuse block to the corresponding receptacle on the BECM, then position back the BECM. See Figure 11.



FIGURE 11

14. Position the fuse block (Item A) on top of the BECM. Connect the original 7 BECM connectors into the corresponding receptacle on the fuse block. See Figure 12.

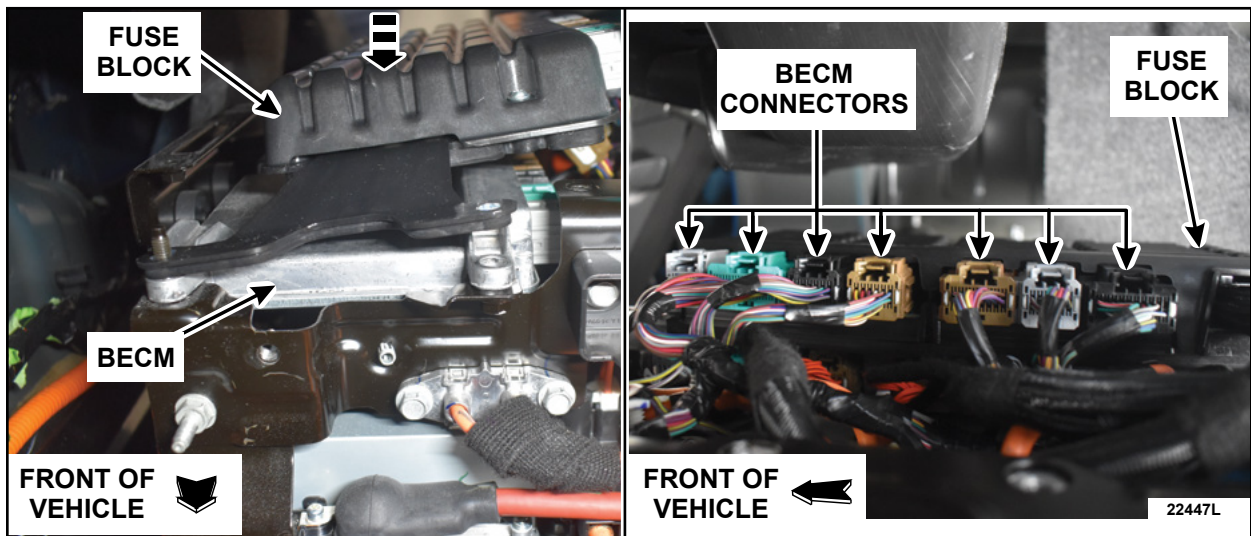

FIGURE 12



15. Install the *new* nut (Item D) and the long bolts (Item F). See Figure 13.

- Torque: 8.9 lb. ft (12.1 Nm)

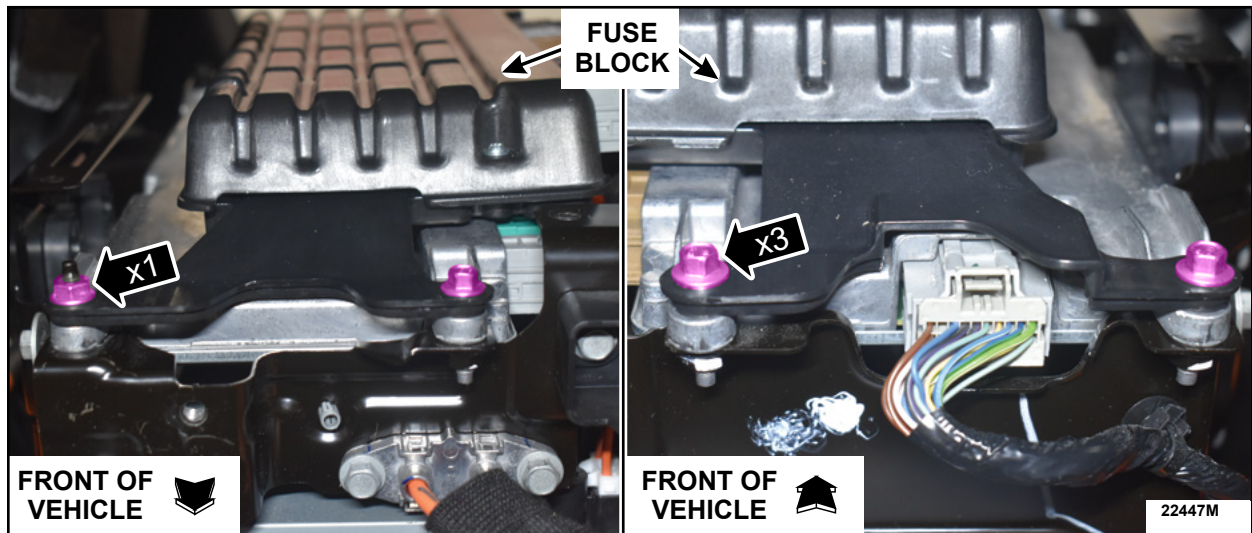

FIGURE 13

16. Position the fuse block harness down into the BECM cavity. See Figure 14.



FIGURE 14



17. Install the new BECM cover (Item B) and the retainers. See Figure 15.

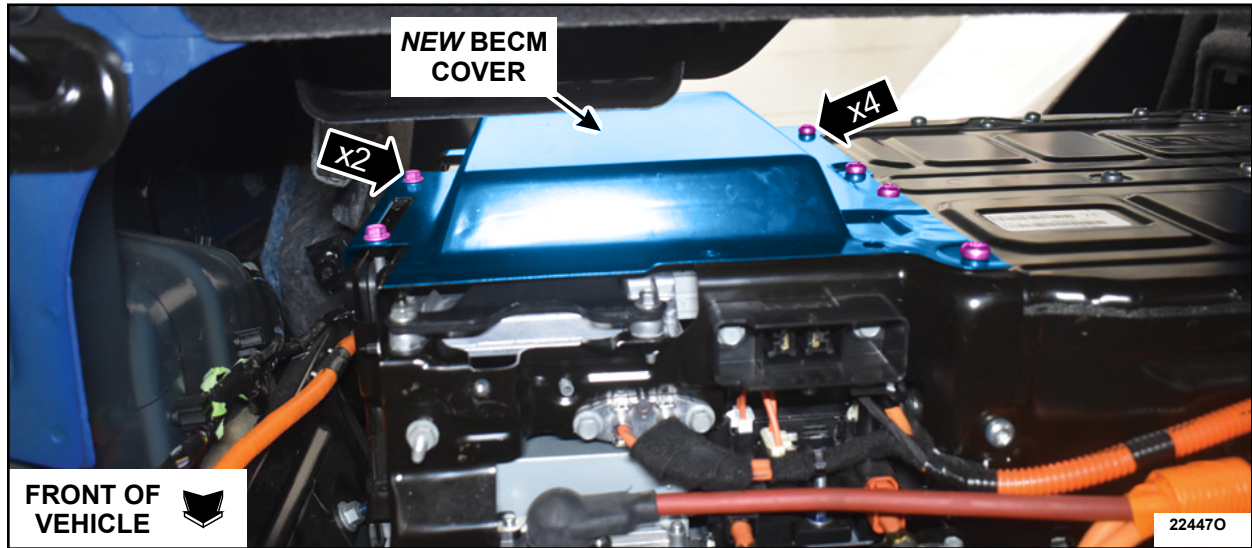

FIGURE 15

18. Install the rear bolt and the two side nuts. See Figure 16.

- Torque: 10.2 lb. ft (13.8 Nm)

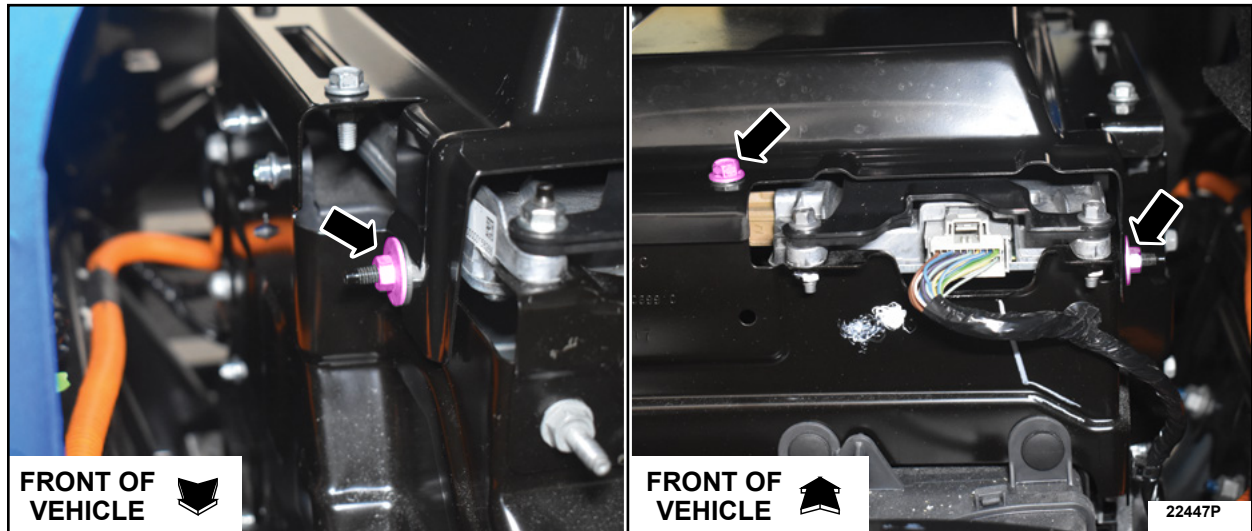

FIGURE 16



19. Tighten the two side bolts. See Figure 17.

- Torque: 10.2 lb. ft (13.8 Nm)

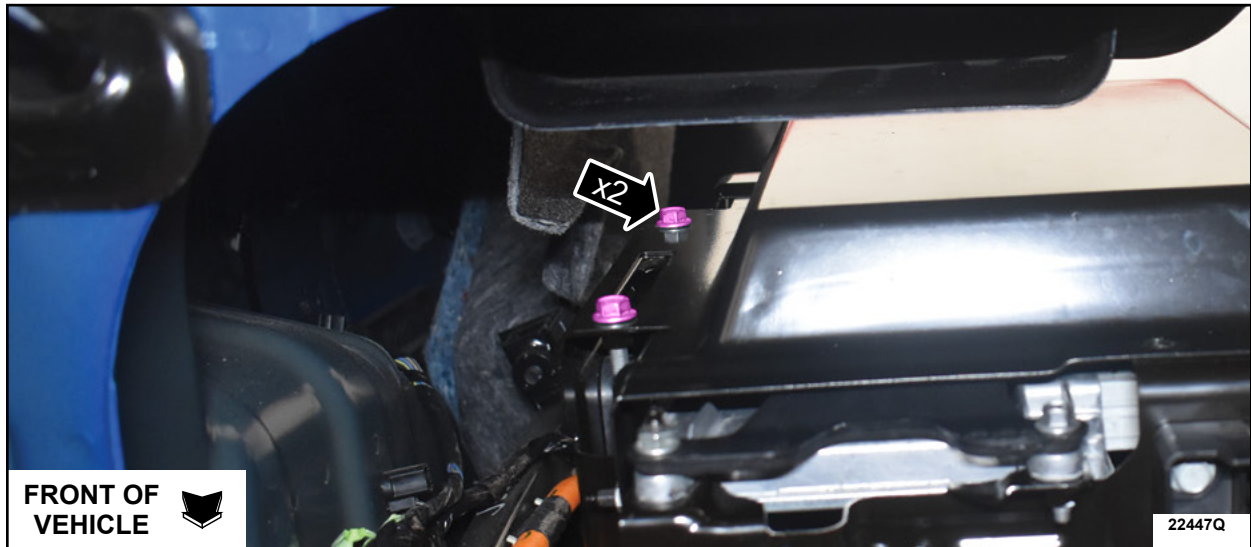

FIGURE 17

20. Tighten the four torx bolts. See Figure 18.

- Torque: 12.7 lb. ft (17.3 Nm)

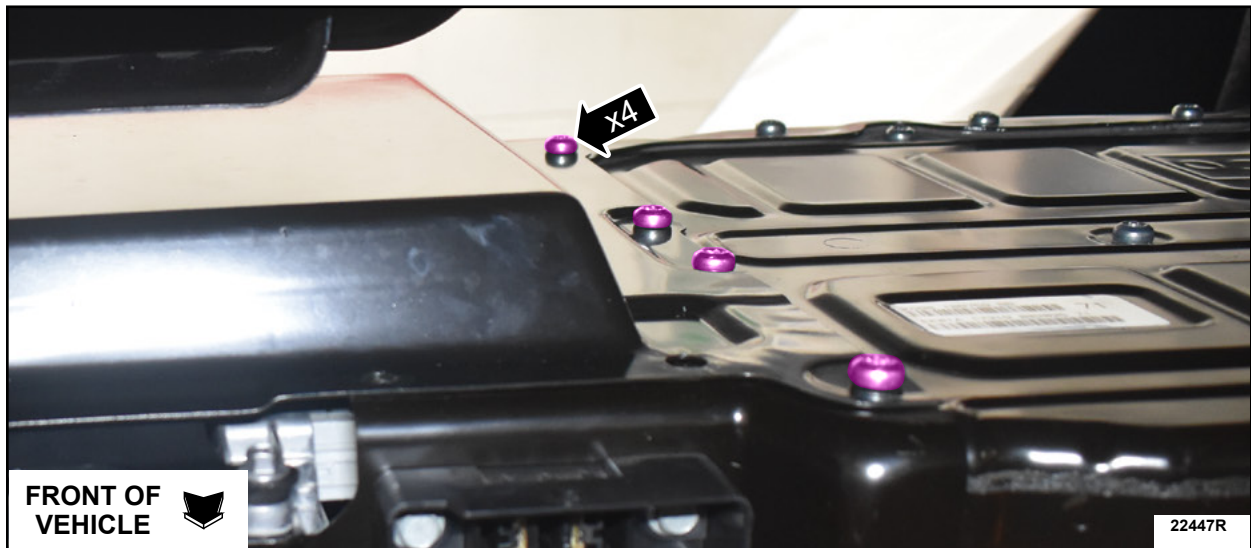

FIGURE 18



21. Install the *new* high voltage fuse bracket. See Figure 19.

- a. Position the *new* high voltage fuse bracket (Item C).
 - b. Install the short bolts (Item G)
 - c. Install the bolt with washer (Item E)
- Torque: 10.2 lb. ft (13.8 Nm)

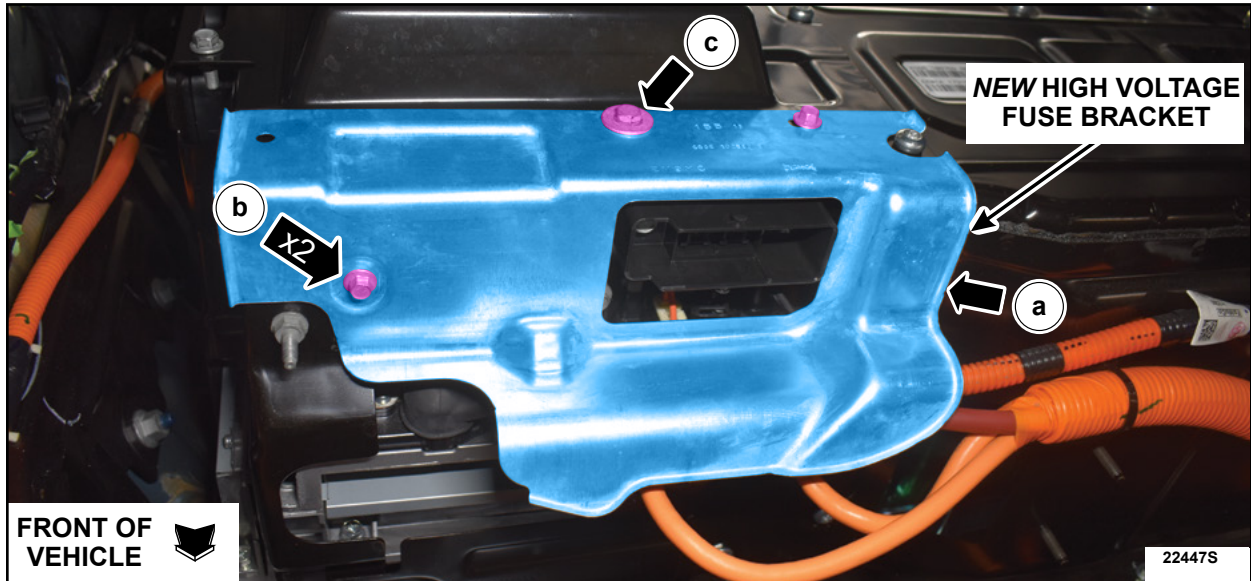

FIGURE 19

22. Install the air duct and the retainers. See Figure 20.

- Torque: 62 lb.in (7 Nm)

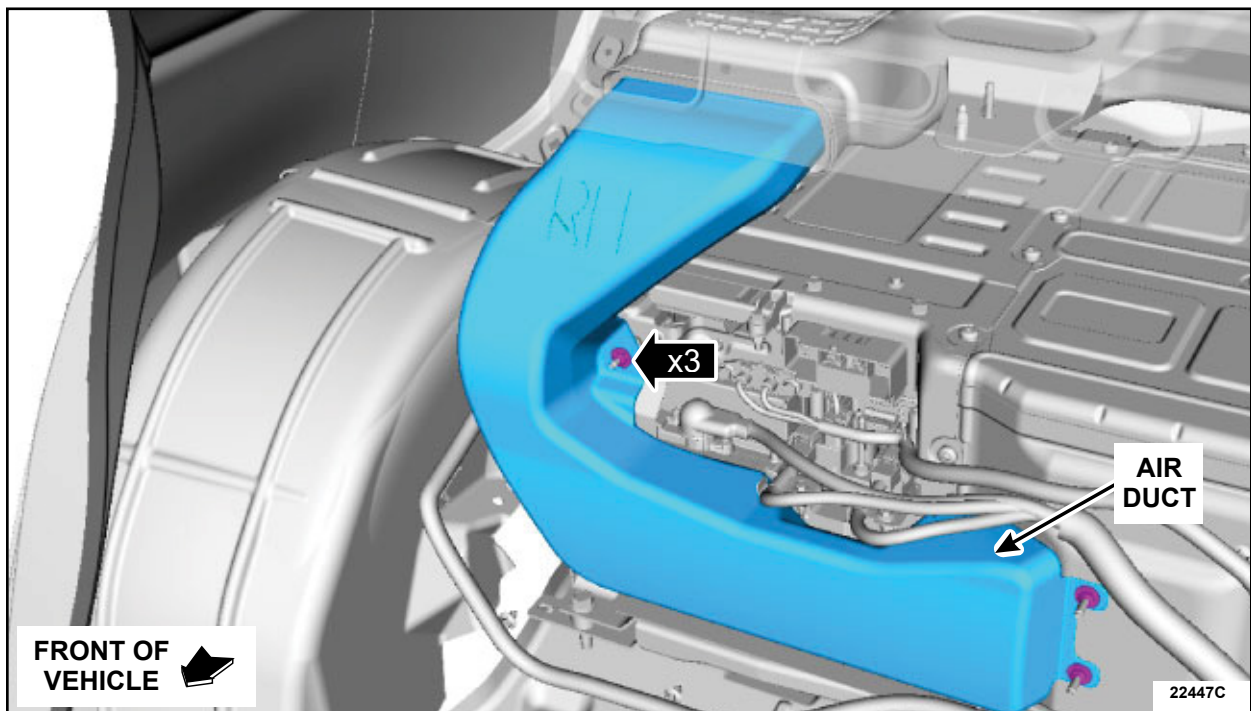

FIGURE 20



23. Install the high voltage battery bracket. See Figure 21.

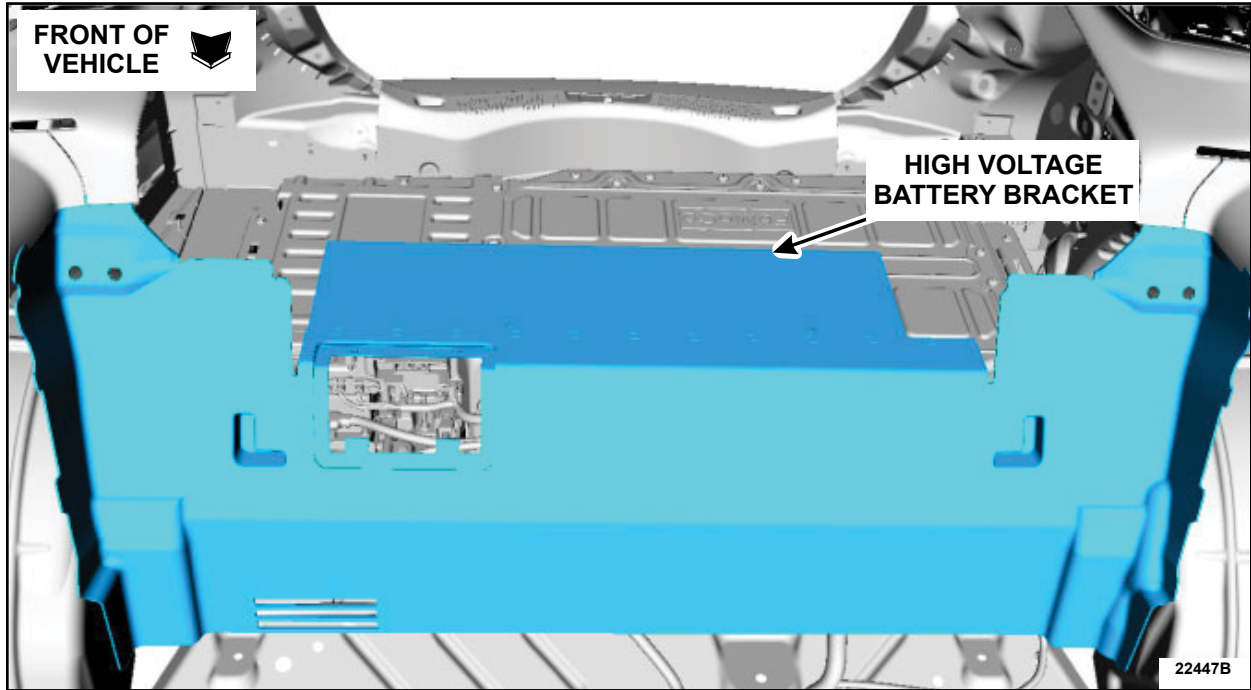

FIGURE 21

24. Install the battery cover, loadspace floor cover and the retainers. See Figure 22.

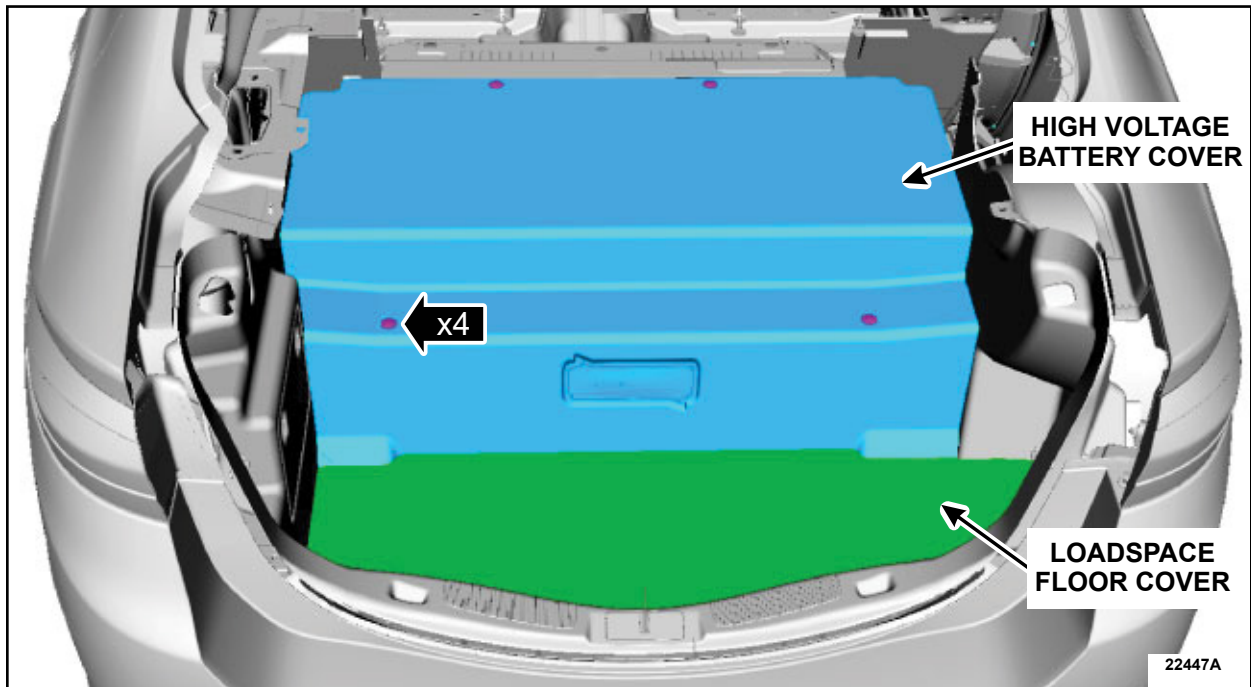

FIGURE 22



25. Install the rear seat cushion. Follow the WSM procedures in Section 501-10B.
26. Connect the 12 V battery. Follow the WSM procedures in Section 414-01.
27. Connect the high voltage battery. Follow the WSM procedures in Section 414-03A.

Module Reprogramming

NOTE: Reprogram appropriate vehicle modules before performing diagnostics and clear all Diagnostic Trouble Codes (DTCs) after programming. For DTCs generated after reprogramming, follow normal diagnostic service procedures.

1. Connect a battery charger to the 12 Volt (V) battery.

- Use of a heavy-duty charger is recommended to maintain proper battery voltage during this procedure.

NOTE: Verify the negative cable of the charger is installed on a chassis or engine ground and not the 12V battery negative terminal to prevent the battery saver mode from activating on the vehicle.

NOTE: Make sure the IDS computer does not enter sleep mode during programming.

2. Reprogram the Powertrain Control Module (PCM) using the Integrated Diagnostic Software (IDS) release 130.05 or higher. Select the IDS menu option, Module Reprogramming, then select PCM and follow all screen prompts.

NOTE: The following modules may also be programmed: BECM, SOBDM-C, ABS, and SOBDM.

NOTE: Calibration files may also be obtained at www.motorcraftservice.com.

NOTE: Follow the IDS on-screen instructions to complete the reprogramming procedure.

3. Check and clear all DTCs.
4. Disconnect the battery charger from the 12V battery once the reprogramming has completed.



Important Information for Module Programming

NOTE: When programming or reprogramming a module, use the following basic checks to ensure programming completes without errors.

- Inspect the Vehicle Communication Module II (VCM II)/Vehicle Communication Module III (VCM III) or the Vehicle Communication and Measurement Module (VCMM) and the cables for any damage. Make sure scan tool connections are not interrupted during programming.
- A hardwired connection is strongly recommended.
- Turn off all unnecessary accessories (radio, heated/cooled seats, headlamps, interior lamps, HVAC system, etc.) and close doors.
- Turn the accessories back on after programming has completed.
- Disconnect/depower any aftermarket accessories (remote start, alarm, power inverter, CB radio, etc.).
- Follow all scan tool on-screen instructions carefully.
- Disable IDS/scan tool sleep mode, screensaver, hibernation modes.
- Create all sessions Key ON Engine OFF (KOEO). Starting the vehicle before creating a session will cause errors within the programming inhale process.

Recovering a module when programming has resulted in a blank module: **NEVER DELETE THE ORIGINAL SESSION!**

- a. Obtain the original IDS that was used when the programming error occurred during Module Reprogramming (MR) or Programmable Module Installation (PMI).
- b. Disconnect the VCM II/VCM III from the Data Link Connector (DLC) and the IDS.
- c. Reconnect the VCM II/VCM III to IDS and then connect to the DLC. Once reconnected, the VCM II/VCM III icon should appear in the corner of the IDS screen. If it does not, troubleshoot the IDS to VCM II/VCM III connection.
- d. Locate the original vehicle session when programming failed. This should be the last session used in most cases. If not, use the session created on the date that the programming failed.

NOTE: If the original session is not listed in the previous session list, click the **Recycle Bin** icon at the lower right of the previous session screen. This loads any deleted sessions and allows you to look through them. Double-click the session to restore it.

- e. Once the session is loaded, the failed process should resume automatically.
- f. If programming does not resume automatically, proceed to the Module Programming menu and select the previously attempted process, PMI or MR.
- g. Follow all on-screen prompts/instructions.
- h. The last screen on the IDS may list additional steps required to complete the programming process. Make sure all applicable steps listed on the screen are followed in order.















Safety Recall 23S33 Mobile Service Repair Assessment

The following assessment will be used to indicate how mobile friendly a program is.

Dealer Bulletin



This system may be broken down by labor operations or models. If the program has an inspection followed by a potential repair, then the assessment level will be broken down into an inspection assessment level and a repair assessment level to show the mobile friendliness of the repair on the vehicle. If the program has multiple repair options (determined by model, model year or options) then the assessment level will also be determined by the options to show the mobile friendliness of the repair on the vehicle.

Assessment Levels

-  - Mobile Reprogramming
-   - Light Mobile Service
-    - Enhanced Mobile Service
-     - Advanced Mobile Service
-  - Wheel and Tire Mobile Service
-  - Not Mobile Service Capable

Description of each level that is used to determine the overall assessment.

-  – Mobile Reprogramming
 - Module Programming or similar type services
 - Minimum tools maybe required other than an **IDS/FDRS** setup
 - FDRS programming that requires internet connection (wi-fi or mobile hotspot)
 - Make sure vehicle has a charge port to ensure battery voltage is maintained during flashing of the module(s)
 - Repairs not greater than 1 hour in length (including time to wait for programming)

Note: The location will need a charging station or wall box to maintain the 12-volt battery
-   – Light Mobile Service
 - Interior repair procedures that do not require seat, dash, or headliner removal
 - Under hood repairs that do not require large component removal
 - Exterior repairs that do not require large component/panel removal
 - Repairs may require standard hand tools (Access to a Technician starter kit or similar)

   – Enhanced Mobile Service

- ***Anytime a procedure requires work under the vehicle to have a two-person process***
 - Brake Inspection and Brake Repair/Replacement
 - Limited Suspension Component replacement (no alignment)
 - Under Vehicle access for limited repairs (no large component removal)
 - Vehicle Check Up - VCU
 - Pre-Delivery Inspection - PDI
 - Used Car Inspection/Presale Inspection
 - May require floor jack, jack stands, and impact tools
- Note: Wheel lock maybe required.*

    – Advanced Mobile Service

- Fluid Exchange/Oil Change
- Light Repairs
- Brake Hydraulic Repairs

 – Wheel and Tire Mobile Service

- Tire Removal from Wheel
- Tire Balancing
- Tire Repair

Note: Specialize Mobile Service unit and equipment including Tire balancer and Tire Changer required.

 – Not Mobile Service Repair Capable

- Large component removal
- BEV Battery Replacement
- Requires a vehicle hoist – to complete the repair (more than inspection)
- Required vehicle alignment
- Requires significant vehicle disassembly
- Repairs greater than 2-3 hours
- Any repairs that require M-Time
- Includes a service procedure where the vehicle owner may be distressed about the state of their vehicle

Safety Recall 23S33

Mobile Repair / Vehicle Pick-Up and Delivery Record

VIN _____ received (check one):

- Mobile Repair
- Pick-up and/or delivery service

As outlined below for the 23S33 Field Service Action program.

Mobile Repair – Date: _____

OR

Pick-up – Date: _____

Delivery – Date: _____

Repair Order #

Repair Order Date

Service Manager Signature

Date

Ford Motor Company
Recall Reimbursement Plan for 23S33

Ford and Lincoln dealers are in the best position to quickly and efficiently process reimbursement requests. However, federal legislation requires all motor vehicle manufacturers to establish processes through which customers may seek recall reimbursement directly from the manufacturer or the dealers.

*Regarding the specific reimbursement plan for Recall # **23S33**, owners who have paid for service to remedy the defect or non-compliance must have had that service performed before July 26, 2024. After this date, if repairs related to this recall are performed by a non-Ford repair facility in an emergency, customers must submit any refund requests through their dealership. As required by this federal regulation, Ford Motor Company submitted the details of its latest General Recall Reimbursement Plan in a letter to the National Highway Traffic Safety Administration (NHTSA) in May 2021. The following is the text of that letter and the Plan:*

General Recall Reimbursement Plan
(As submitted to the NHTSA)

Pursuant to the requirements set forth in 49 CFR Part 573 and Part 577 of the Code of Federal Regulations, Ford Motor Company (Ford) is submitting required information pertaining to our general reimbursement plan for the cost of remedies paid for by vehicle owners before they are notified of a related safety recall.

Set forth below is Ford's general plan to reimburse owners and purchasers for costs incurred for remedies in advance of notification of potential safety-related defects or non-compliances pursuant to Part 573.6 (c)(8)(i). This plan has not changed since our May 5, 2021 submission.

Reimbursement Notification

Ford's notice to a vehicle owner in accordance with 49 CFR Part 577 will indicate that Ford is offering a refund if the owner paid to have service to remedy the defect or noncompliance prior to a specified ending date. In accordance with Part 573.13 (c)(2), this ending date will be defined as a minimum of ten calendar days after the date on which Ford mailed the last of its Part 577 notifications to owners and will be indicated in the specific reimbursement plan available to owners for an individual recall. This notice will direct owners to seek eligible reimbursement through authorized dealers or, at their option, directly through Ford at the following address:

Ford Motor Company
P.O. Box 6251
Dearborn, MI 48121-6251

Ford notes that this rule allows for the identification of a beginning date for reimbursement eligibility. Under the rule, an owner who paid to remedy the defect or noncompliance prior to the identified beginning date would not be eligible for reimbursement. Ford generally has not established such a beginning date for reimbursement eligibility and does not presently anticipate changing this general policy. However, in any case where Ford determines a beginning date is appropriate, Ford will indicate that date in the owner notice. As permitted by 577.11(e), Ford may not include a reimbursement notification when all vehicles are well within the warranty period, subject to approval by the Agency.

Costs to be Reimbursed

For vehicles, reimbursement will not be less than the lesser of:

- The amount paid by the owner for the remedy that specifically addressed and was reasonably necessary to correct the defect or noncompliance that is the subject of the recall, or
- The cost of parts for the remedy (to be no more than the manufacturer's list retail price for authorized part(s), plus associated labor at local labor rates, miscellaneous fees (such as disposal of waste) and taxes.

For replacement equipment, reimbursement will be the amount paid by the owner for the replacement item (limited by the amount of the retail list price of the defective or noncompliant item that was replaced, plus taxes, where the brand or model purchased by the owner was different than the brand or model that was the subject of the recall). If the item of motor vehicle equipment was repaired, the reimbursement provisions identified above for vehicles will apply.

Ford notes that costs incurred by the owner within the period during which Ford's original or extended warranty would have provided for a free repair of the problem will not be eligible for reimbursement, as provided by Part 573.13 (d)(1).

Entities Authorized to Provide Reimbursement

Ford will continue to use authorized dealers to reimburse owners under the specific reimbursement plans for a particular recall and will encourage owners to pursue requests for reimbursement directly through dealers to expedite reimbursement. Ford will also provide a mailing address to which customers can, at their option, send requests for reimbursement directly to Ford, as previously noted. Requests for reimbursement sent directly to Ford may take up to 60 days to process. Whether the owner chooses to pursue reimbursement requests through a dealer or directly through Ford, the owner will be directed to submit the required documentation, upon which reimbursement eligibility will be determined.

Required Documentation

The reimbursement determination will depend upon the information provided by the customer. Consistent with Part 573.13 (d)(4) the following information must be submitted:

- Claimant name and address
- Vehicle make, model and model year
- Vehicle identification number (VIN) and, for replacement equipment, a description of such equipment or, for tires, the model, size and TIN (DOT code)
- Identification of the recall number (either the Ford recall number or the NHTSA recall number)
- Identification of the owner of the recalled vehicle at the time that the pre-notification remedy was obtained
- An original receipt for the pre-notification remedy that includes a breakdown of the amount for parts, labor, other costs and taxes, including costs for the replacement item. Where the receipt covers work other than to address the recall or noncompliance, Ford may require the claimant to separately identify costs that are eligible for reimbursement.
- If the remedy was obtained during the warranty repair did not correct the problem related to the recall

Failure to submit all the above information may result in denial of the reimbursement request.

Additional Information

The Part 577 required owner notice will provide a toll-free telephone number through which specific information about the reimbursement plan can be requested from Ford. This general reimbursement plan will be incorporated into notifications pursuant to Part 573.6 by reference. Information specific to an individual recall also may be incorporated into the Part 573.6 notification.