



**RECALL**

<b>ORIGINAL CREATION DATE:</b>	08/30/2023
<b>REVISION DATE:</b>	09/11/2023
<b>SUBJECT:</b>	400V E2Ver1 Body and ESM Software Update
<b>RATIONALE:</b>	Updates to vehicle response when certain fault codes associated with battery pack liquid accumulation and/or a thermal event are detected.
<b>VINs or MODELS AFFECTED:</b>	Service Specified Buses
<b>COMPLETE BY:</b>	Earliest Service Opportunity
<b>SERVICE CAMPAIGN #:</b>	SC-23-126
<b>NHTSA RECALL NUMBER:</b>	22V887
<b>REMEDY KIT NAME / NUMBER:</b>	065660
<b>ESTIMATED LABOR TIME:</b>	.75
<b>LABOR OP CODE:</b>	HB49V

**NOTICE! It is expected that this process may require up to ¾ Hour per bus. Please schedule appropriately to minimize vehicle downtime.**

## **400V E2Ver1 Body and ESM Software Update**

### **Retrofit Description:**

This software update enables the following features when certain fault codes associated with Battery Pack liquid accumulation and/or a thermal event are detected. (1) prevent the vehicles Battery Pack from being charged, (2) engage a “limp mode” that imposes limitation on the Battery Pack regen and power discharge levels, and (3) trigger a flashing red warning light on the driver’s dash display and an audible alarm (collectively, the “Updated Software Features”).

For additional details regarding the Updated Software Features including but not limited to recommended owner/bus driver actions in response to the Updated Software Features warnings, please refer to the enclosed Proterra EV Battery Fire Safety Guide.

If you have questions about the procedures specified in this bulletin for performing the Software Update for this safety recall campaign, please contact Proterra directly for clarification at:

**Proterra Customer Service Team**

**864-438-0000**

**Service@Proterra.com**

**Reporting Work Completion:**

PROTERRA REPORTING REQUIREMENT: The provided form MUST BE COMPLETED for each vehicle undergoing this procedure.

Perform the Body and ESM Software Recall procedure before reporting work completion. Please collect all relevant data regarding the repair as specified on the Verification Form and report all work completion to Proterra using the 400V E2Ver1 Body and ESM Software Recall FORM (provided in this bulletin and as a separate document) promptly upon completion of the work.

**NOTICE:** Customers performing this recall campaign must also submit the Proterra Warranty Form provided in this bulletin and as a separate document for any labor costs incurred.

**Tools/Parts Required:**

**Tools and Supplies Required:**

T-30 Torx Driver	
Customer Service Laptop With Proterra Diagnostic Tool	
Nexiq USB Link2 Device	

**Kit Parts Required:**

065660	Service Retrofit Kit, BATTERY DIAGNOSTICS ENHANCEMENT, 400V E2 Ver1 Tachograph Odometer	
065620	SOFTWARE, BODY CONTROLLER 400V ZR32A, V40.33X04 Firmware	
065749	SOFTWARE, E2 ESM, v3.0.2	

## Procedure:

1. Turn ON the 12/24V rear Vehicle Master Disconnect located behind the vehicle curbside rear charge port access panel.
2. Turn ON the bus Master Run Switch at the Driver's Workplace and ensure the Dash screen is ON to display "KEY ON".
  - a. This places the vehicle into Key On / Low Voltage state for controller versions to be checked prior to software flash.
3. Using a T30 Torx screwdriver or appropriate tools, remove the two access covers.
  - a. Street side wheel well electronics cabinet (ECAB) panel for access to the OBDII Port



- b. Rear deck access panel for OBDII Diagnostic port (NOTE: on E2-35 foot buses this is located behind the rear barn doors on the left hand side).
4. Power up (boot) the Proterra-supplied laptop containing the Proterra Diagnostic Tool.
5. Connect the Nexiq USB Link2 device to the laptop and to the appropriate OBDII Diagnostic Port.



6. For example, here is the Nexiq USB Link connected to the Diagnostic Port located on the street side wheel well electronics cabinet (eCab).

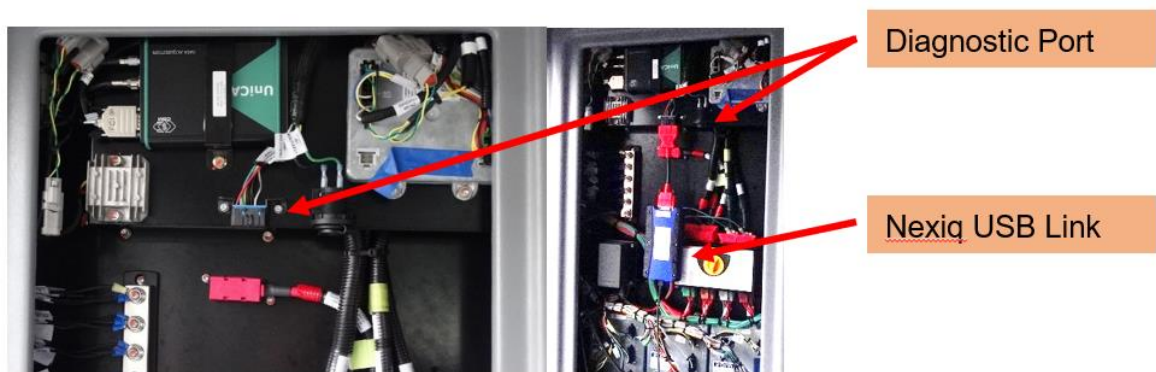

7. On the laptop, double-click on the Proterra Diagnostics Tool software icon to start the software.



8. When the program opens, read and click OK for the prompt.
9. On the Home tab, select the appropriate device from the drop down and click "Connect".

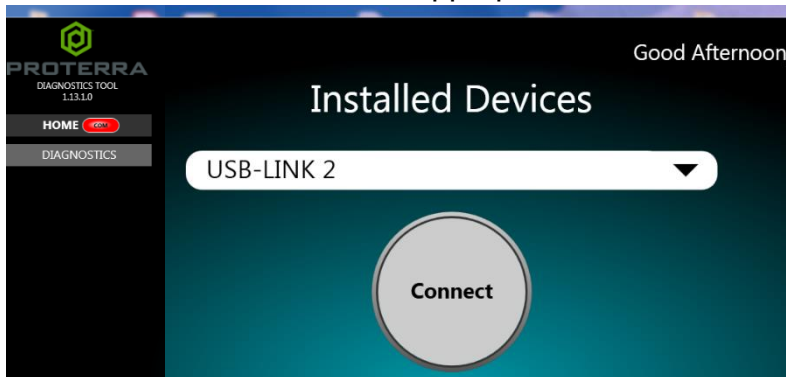

10. Once the diagnostic tool has connected to the vehicle, you will have a VIN number and connection status displayed on the home screen, and tabs available to navigate.

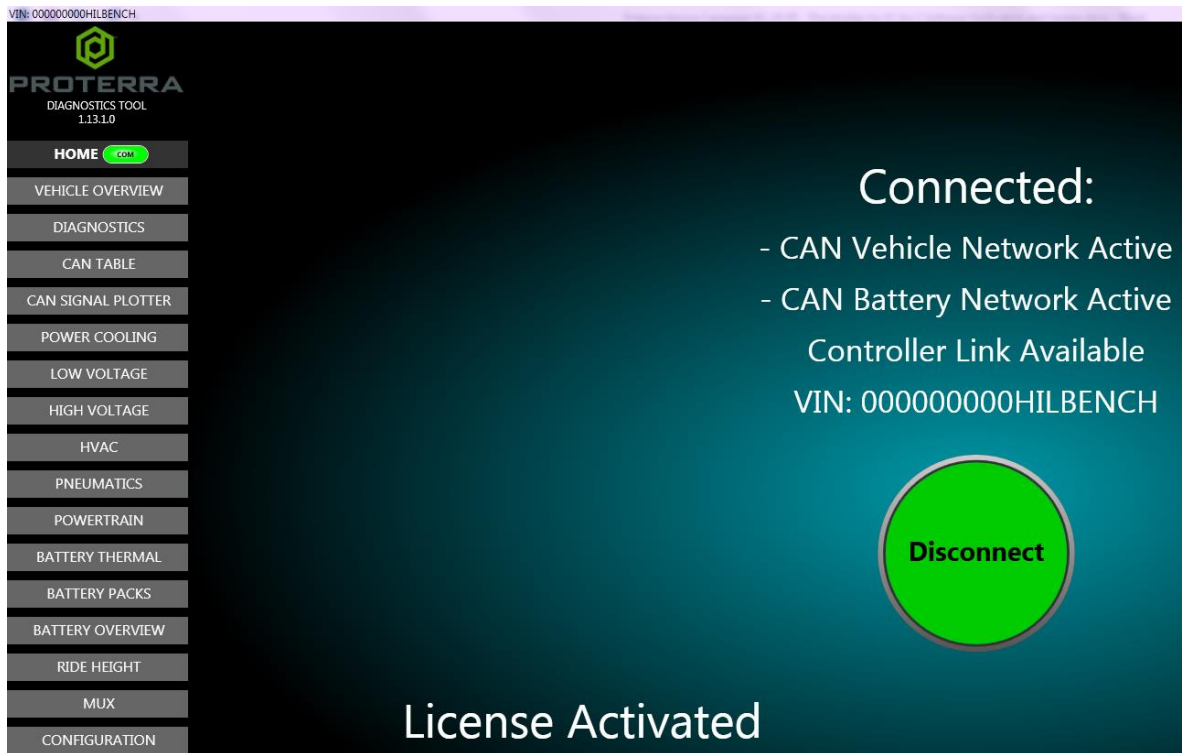

## Update Body Controller Software

This procedure updates the Body Controller software version and maintains the body controller parameter configuration data across the flash download of new software.

11. Ensure you have the latest software file “SOFTWARE, BODY CONTROLLER 400V ZR32A, V40.33X04 Firmware” in a known location on the service technician’s computer (Folder or Desktop).  
**IMPORTANT! NEVER** access the software from a remote server or from a USB memory device, **ALWAYS** copy the software files to your computer hard drive and access the software from this location.
12. Turn **ON** the 12/24V rear Vehicle Master Disconnect located behind the vehicle curbside rear upper access panel
13. Turn **OFF** the bus Master Switch at the Driver's Workplace and ensure the Dash screen is **OFF**.
14. Turn **ON** the bus “programming switch” inside the **street side** wheel well box.
15. After connecting to the vehicle using the Proterra Diagnostic tool at the **front OBDII Port (SSWW Ecab)**, navigate to the Configuration Tab.
16. Wait at least 10 seconds after starting the tool, then click the “Get Parameters” button at the top of the page.

- a. **NOTE:** This ensures that we have a backup copy of the original configuration parameters stored in a “zip” file, contained in the C:/Logs folder on your computer in case you have to refer to it later.

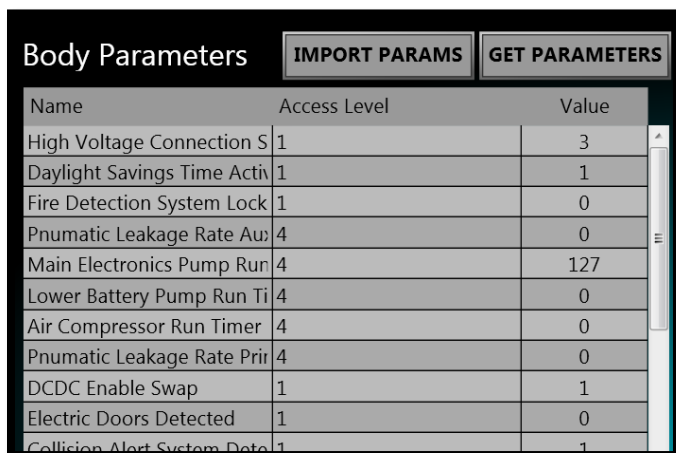

Name	Access Level	Value
High Voltage Connection S	1	3
Daylight Savings Time Activ	1	1
Fire Detection System Lock	1	0
Pnumatic Leakage Rate Au	4	0
Main Electronics Pump Run	4	127
Lower Battery Pump Run Ti	4	0
Air Compressor Run Timer	4	0
Pnumatic Leakage Rate Pri	4	0
DCDC Enable Swap	1	1
Electric Doors Detected	1	0
Collision Alert System Date	1	1

17. Now we are ready to click the Body Firmware “Start Flash” Button.

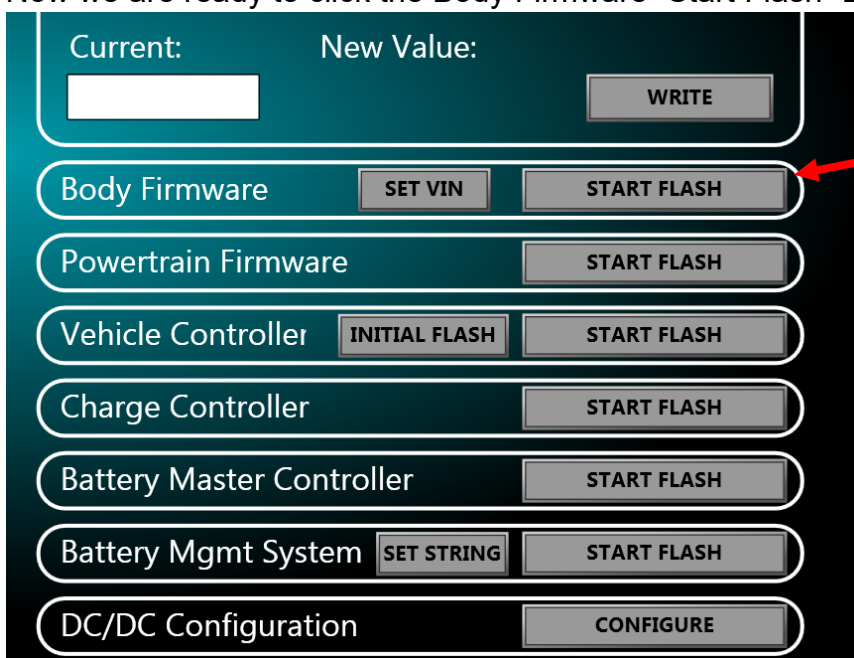

Current:  New Value:

Body Firmware

Powertrain Firmware

Vehicle Controller

Charge Controller

Battery Master Controller

Battery Mgmt System

DC/DC Configuration

Beside Body Firmware, Click Start Flash

18. The following screen will be displayed. Navigate to the location where you stored the configuration file earlier. Select the software file downloaded previously and click “Open” to load the file.

**Note:** The file name displayed should be “CatalystBody\_40\_33x04\_PN065620”.



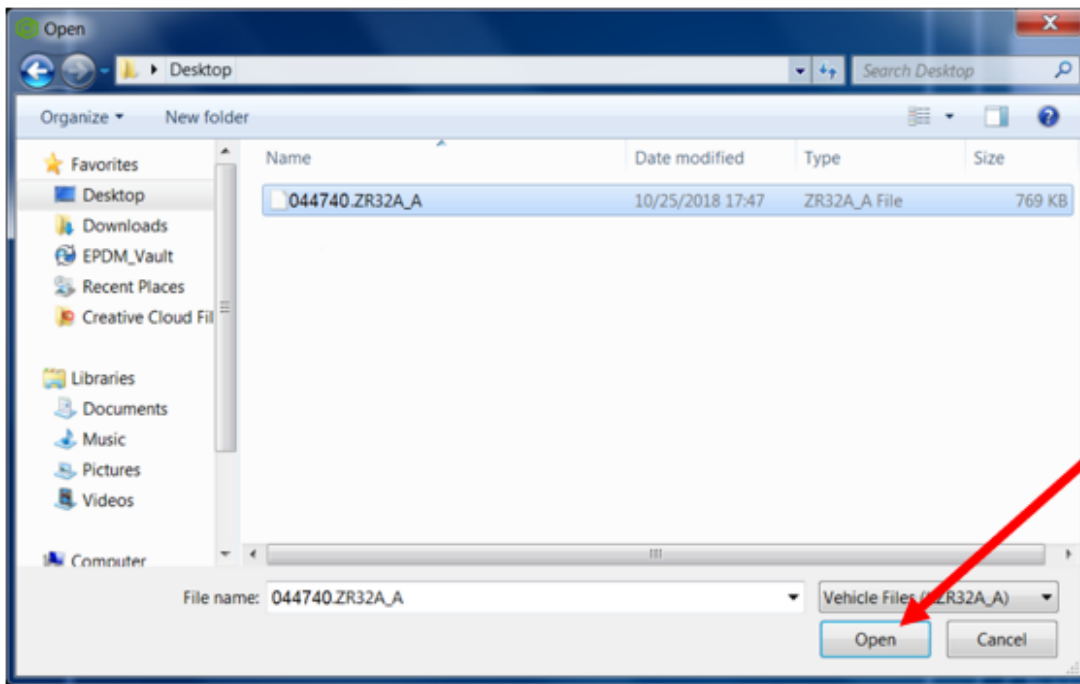

Select the file and  
Click Open

19. The Proterra Diagnostic Tool will connect to the device, and the following screens are displayed.

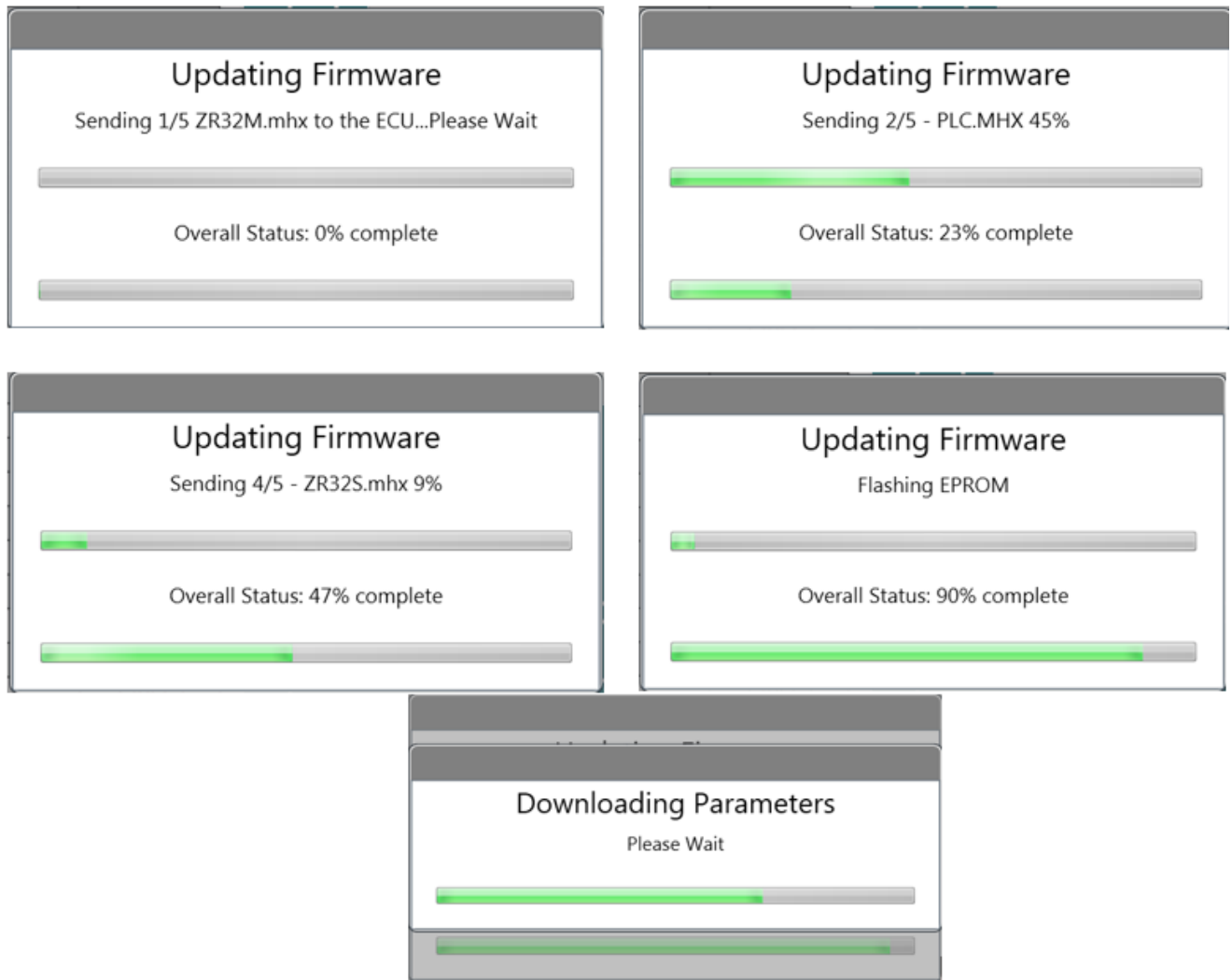



20. The software update will take several minutes to complete. When the update is complete the following screen will be displayed. Click the “Finish” button to complete the update process.

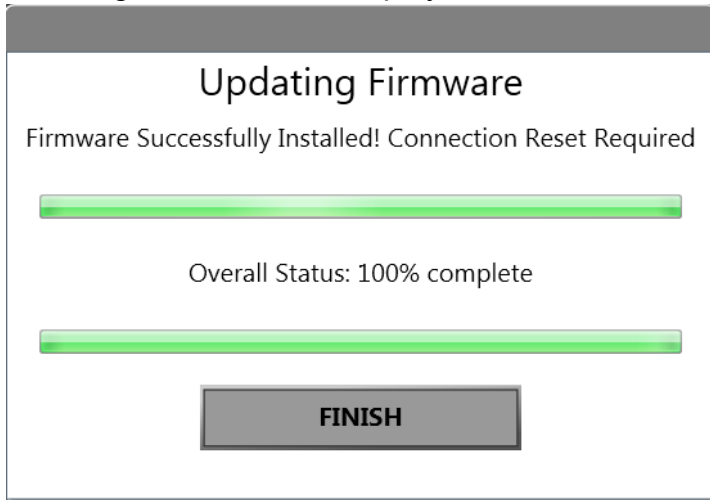

21. Turn off the vehicle at the rear master switch.

### Update the Charge Controller Software for Customer Vehicles (using Proterra Diagnostic Tool):

The purpose of this procedure is to update the Charge Controller software version using the Proterra Diagnostics Tool.

Access the following file to obtain the new configuration file: On ServiceMax Campaign file attachments. “esm-production\_Catalyst\_E2\_Bootloader\_20230925\_1609”

22. Copy the software file esm-production\_Catalyst\_E2\_Bootloader\_20230925\_1609 to a known location on the service technician’s computer (Folder or Desktop)
- IMPORTANT! NEVER** access the software from the USB memory device, ALWAYS copy the software files to your computer hard drive and access the software from this location.
23. Turn **ON** the 12/24V rear Master Disconnect located behind the vehicle curbside rear upper access panel.
24. Turn **OFF** the bus High-Voltage Master Switch at the Driver's Workplace and ensure the Dash screen is **OFF**.
25. Turn **ON** the bus “programming switch” inside the **street side** wheel well box.
26. Power up (boot) the Proterra-supplied laptop containing the Proterra Diagnostic Tool. Connect the Nexiq USB Link to the laptop.  
**Note:** Using a USB cable connection, rather than Wi-Fi is required.



27. On the laptop, double-click on the Proterra Diagnostics Tool software icon to start the software.



28. On the Proterra Diagnostics screen, select "USB-LINK 2" in the drop-down box then click the "Connect Button".

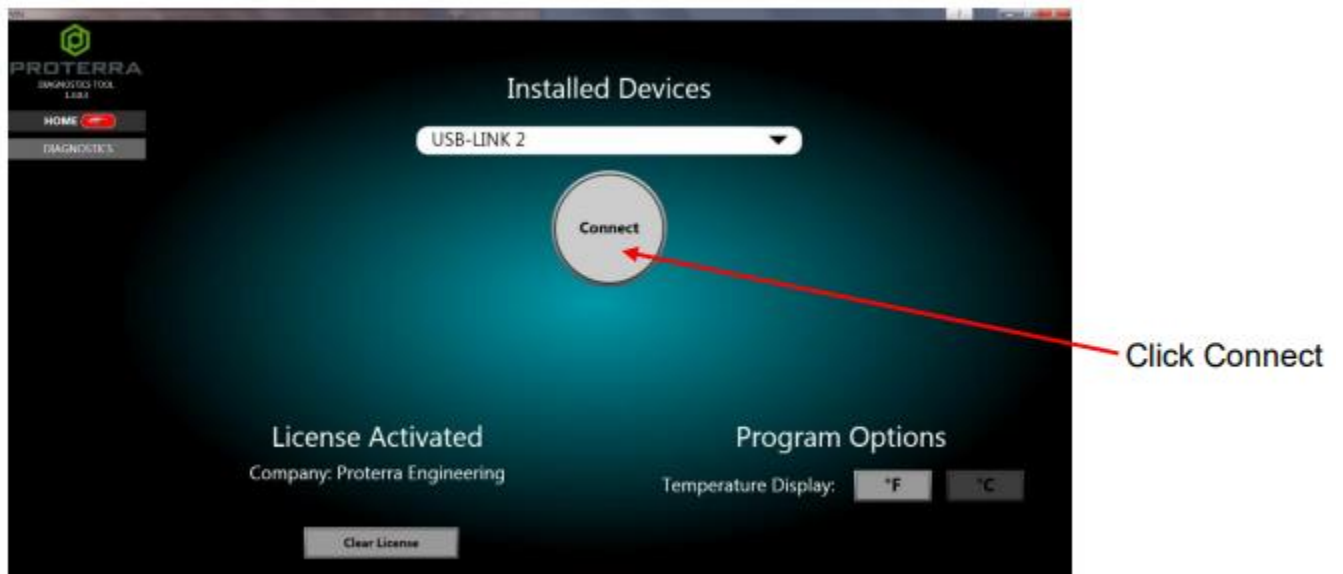

29. The Home screen will open. Click on the "Configuration Button" to open the Configuration screen and then click the Battery Master Controller "Start Flash" Button

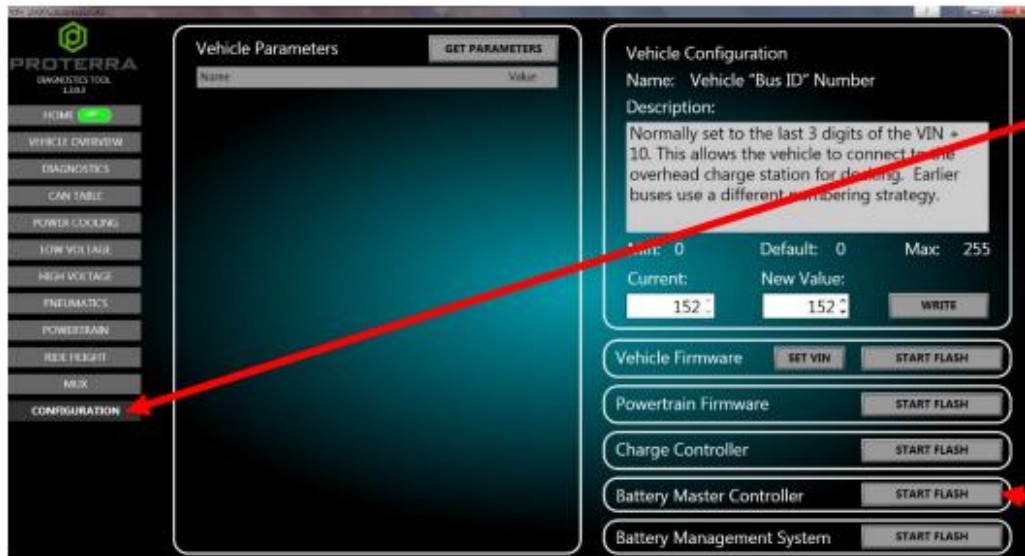

Click Configuration

Beside Battery Master Controller, Click Start Flash

30. The following screen will be displayed. Navigate to the location where you stored the configuration file earlier. Select the file and click “Open” to load the file.

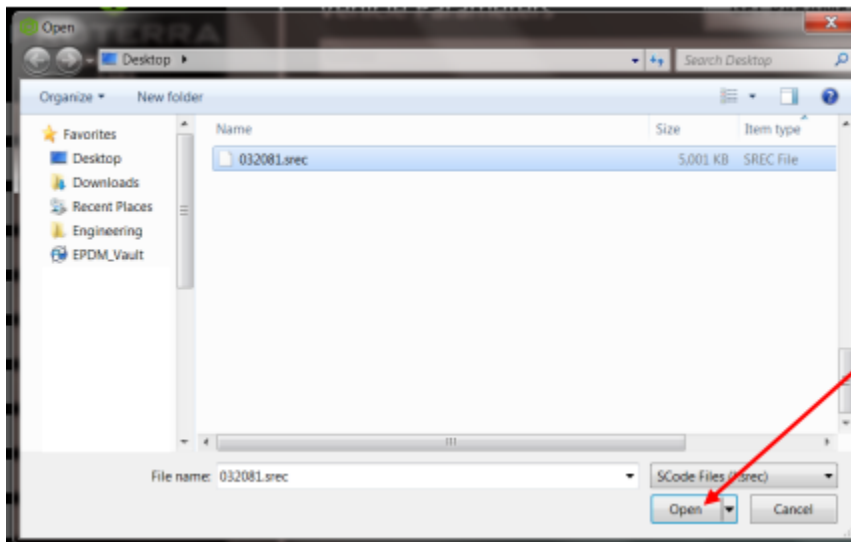

Select the file and Click Open

31. The Proterra Diagnostic Tool will attempt to connect to the device.  
**NOTE:** You may receive an error on the first attempt. If so, retry by clicking the Battery Master Controller Start Flash button again.

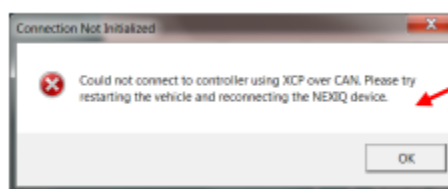

Error message on failed first attempt

32. When the software update begins, and the following screens will be displayed.

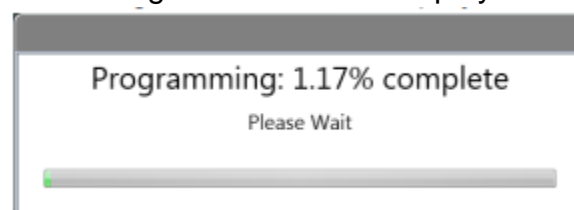
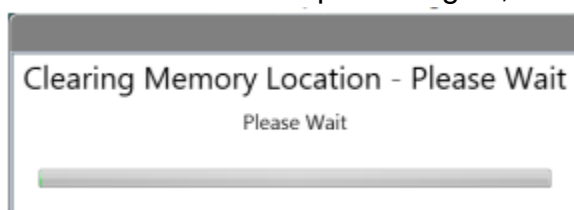

33. The software update may take several minutes to complete. When the update is complete the following screen will be displayed. Click the “OK” button to complete the update process.

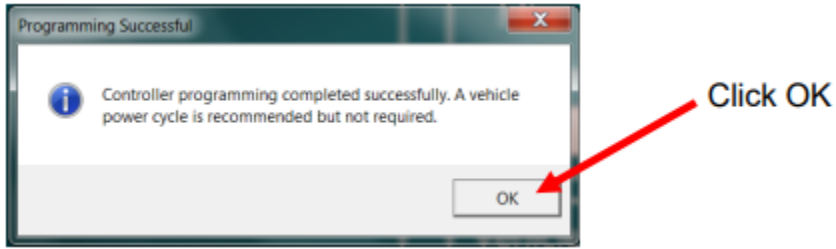

34. The software update is now complete.
35. Remove all flashing equipment and return vehicle to service.

# **Proterra EV Battery Fire Safety Guide**

## **Thermal Event Diagnostics, Prevention & Response**

### **LEGAL DISCLAIMER**

#### **PLEASE READ**

**This document provides general guidance to the owner/customer (“Owner”) to develop its own safe work procedures related to Proterra’s electric vehicle and electric vehicle battery pack (individually and collectively, the “Product”). Any reference to standards, regulations or laws is not exhaustive, nor intended to advise the Owner of its legal duties or compliance obligations.**

**This document is not based on a specific Product configuration. Proterra assumes that all who purchase the Product have expertise to properly and safely receive, handle, store, use, and service the Product. Accordingly, this document is intended as a helpful supplement for the Owner and not a substitute for the Owner’s expertise or responsibility regarding these topics. If any Owner lacks such expertise or does not agree to the foregoing limited purpose, such Owner should immediately notify Proterra in writing and should not procure, take delivery of, or use the Product.**

**This document is provided “as is,” and Proterra assumes no liability or responsibility for any loss, damage or expense resulting from the Owner’s, or any agent or affiliate of the Owner’s, reliance upon, or use of, this document. Proterra makes no warranty or representation, and expressly disclaims any such warranties or representations, that the content of this document is complete, accurate, reliable or error free, to the fullest extent permitted by applicable law. Each Owner assumes the entire risk as to its reliance upon, or use of, this document. Proterra is not responsible to update the content of this document at any time, including based on changes, combinations, or conversions of the Product.**

# 1 FIRE-SAFETY GUIDELINES FOR AN EV BATTERY

---

- a) In the event there is a battery fire, immediately stop operating or working in/around the vehicle. All individuals should move *at least* twenty feet away from the vehicle.
- b) Immediately call the local emergency number (e.g., “911”) to report the battery fire and ask for assistance from fire, police, and medical departments. See First Responder Guide below.
- c) It requires specialized training and personal protective equipment (“PPE”) to safely extinguish a battery fire. The Owner should establish a site-specific safety plan related to EV vehicles and all on-site first responders should be trained to execute the safety plan. The safety-plan should take the following factors into consideration:
  - i) A battery fire may require application of **large amounts of water** to the battery pack for a **long period of time** from a **safe distance** to extinguish a battery fire.

**Do not:**

- Stand close to the vehicle while attempting to extinguish a battery fire.
  - Attempt to open a battery pack for purposes of cooling it with water.
  - Attempt to extinguish a battery fire with a small, limited quantity of water.
  - Use an “ABC” rated fire extinguisher to put out a battery fire.
- ii) **Always** wear the appropriate PPE, including full body covering fire-fighting clothing and self-contained breathing apparatus. Hot metals may be ejected from the battery during a fire, and materials contained inside the battery pack are flammable, corrosive, and should not be inhaled or allowed to contact the eyes or skin.
  - iii) The battery pack may vent hot gases composed of volatile organic compounds such as alkyl-carbonates, methane, ethylene, and ethane, as well as hydrogen gas, carbon dioxide, carbon monoxide, soot, and particulates containing oxides of nickel, aluminum, lithium, copper, and cobalt. Vented gas temperatures may exceed 600°C. The gases may cause burns upon contact. The gases may ignite unexpectedly creating a fire or explosion.
  - iv) Battery pack fires may require up to 24 hours to extinguish. It may be necessary to allow the battery pack to burn while protecting structures or other objects in the vicinity. When all smoke and fire has visibly subsided and cleared, a thermal imaging camera should be used to actively measure the temperature of the high voltage battery and monitor temperature trends — i.e., is the battery consistently cooling down over time, or is it heating up again?
  - v) The battery pack must be completely cooled and there must not be fire, smoke, or heat present in the high voltage battery for at least one hour before the vehicle can be released to second responders (such as vehicle transporters). Second responders must be advised that

there is a risk of battery pack re-ignition. Damaged high voltage lithium ion batteries require special transportation measures, and therefore are prohibited from regular transportation.

- vi) Do not contact any high voltage components and always use insulated tools during overhaul.
- vii) A battery fire may damage the vehicle's airbag inflators, stored gas inflation cylinders, gas struts, and other components which can result in an unexpected explosion. A full "knock down" procedure should be performed.

d) First Aid Measures

- i) **Electric Shock/Electrocution:** Seek immediate medical attention (suspected or confirmed); call 911.
- ii) **Contact with Leaked Material (Electrolyte, Coolant):** The contents of an open or broken constituent battery cell may cause skin irritation and/or chemical burns. In the event of contact, immediately flush skin with water and wash affected area with soap/water. Seek immediate medical attention if a burn or other irritation does not resolve. For eye contact, immediately flush with a significant amount of water for at least 15 minutes without rubbing and seek immediate medical attention; call 911.
- iii) **Vapor or Gas Inhalation (Electrolyte Vapor, Vent Gas):** Immediately move to fresh air source. If not breathing, perform artificial respiration and call 911.



## 2 FIRST RESPONDER GUIDE

Information for first responders to respond to a battery fire involving an electric vehicle can be found at the National Fire Protection Association website:

<https://www.nfpa.org/Training-and-Events/By-topic/Alternative-Fuel-Vehicle-Safety-Training/Emergency-Response-Guides/Proterra>

A sample of the information for first responders located at this website is shown below for reference. First responders may also contact Proterra at [service@proterra.com](mailto:service@proterra.com) if they have any questions.

If a fire develops, the Incident Commander should determine whether an attempt will be made to suppress the fire (aggressive firefighting) or allow the battery pack to burn until it self extinguishes, while protecting surrounding materials (defensive firefighting). Establish a 20 foot radius "safety zone" around the vehicle.

Virtually all fires involving lithium-ion batteries can be controlled with water. To date, water has been found to be the most effective agent for controlling lithium-ion battery fires. Water will suppress flames and can cool cells, limiting propagation of thermal runaway reactions. If water is used, electrolysis of water (splitting of water into hydrogen and oxygen) may contribute to the flammable gas mixture formed by venting cells, burning plastic, and burning of other combustibles. Thus copious volumes of water should be used to fight a lithium-ion battery fire.

Gaseous agents such as CO2 or Halon, or dry chemical suppressants may temporarily suppress flaming of lithium-ion battery packs, but they will not cool lithium-ion batteries and will not limit the propagation of cell thermal runaway reactions. Metal fire suppressants such as LITH-X, graphite powder, or copper powder are not appropriate agents for suppressing fires involving lithium-ion battery packs as they are unlikely to be effective.

A battery fire may continue for several hours and it may take 24 hours or longer for the battery pack to cool. A lithium-ion battery fire that has been extinguished can re-ignite due to the exothermic reaction of constituent materials from broken or damaged cells. To avoid this, remove sources of ignition and cool the burned mass by flooding with water.

**WARNING** When fire is present, always wear appropriate PPE, including self-contained breathing apparatus.

**NOTE:** Direct hose streams toward the outside edge of the battery packs as shown in the diagram below. Apply copious amounts of water.

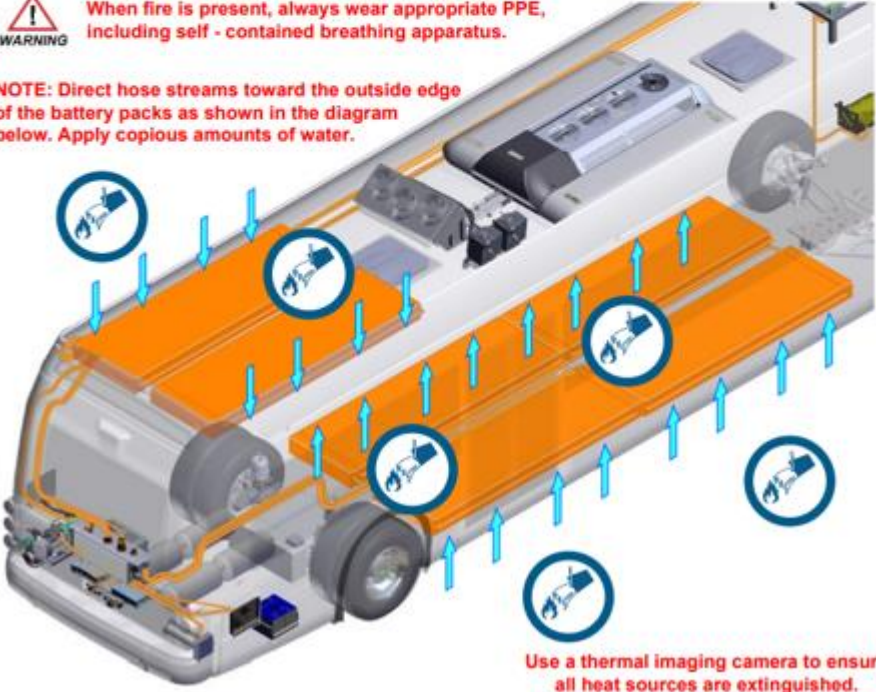

Use a thermal imaging camera to ensure all heat sources are extinguished.

## 3 BACKGROUND

---

### 3.1 THERMAL EVENT VS. THERMAL RUNAWAY.

Each Proterra battery consists of multiple battery cells. Proterra’s diagnostic system is set up to detect a battery “thermal event” where a single battery cell fails in a manner that may cause an unintended chemical reaction to occur inside the cell. The battery pack is designed to contain a single battery cell “thermal event” and prevent a “thermal runaway” (or fire) that involves neighboring battery cells. A “thermal runaway” may occur if other abnormal conditions exist such that the single cell “thermal event” is not contained (e.g., physical impact that causes significant damage to the battery pack). A “thermal runaway” is detectable by smoke, a burning smell, a flame, and other indications of a fire.

If there are any signs that the battery pack may be experiencing a “thermal runaway,” or fire (e.g. smoke, a burning smell, abnormal popping or whistling noises, a flame, etc.), then you must immediately discontinue use of the vehicle and follow the emergency guidelines outlined in the above Fire-Safety Guidelines for an EV Battery.

### 3.2 DIAGNOSTICS, DRIVER NOTIFICATION & VEHICLE RESPONSE

Proterra vehicles have battery sensors and diagnostics used to detect signals related to temperature, humidity, internal pack air pressure and isolation. If an abnormal battery condition is detected, Proterra’s diagnostic system will transmit a message on the vehicle CAN bus. This information will be communicated to the driver via the vehicle dash as described below.

Critical battery faults which indicate the potential for a thermal event will result in a Fast Flash Red Stop Lamp in the vehicle dash that blinks at a rate of two times per second, and an audible alarm that pulses twice per second (collectively, the “Critical Battery Fault Warnings”). *Critical Battery Fault Warnings indicate a critical battery failure which could result in a thermal event.* When the Critical Battery Fault Warnings are active, please immediately follow the procedures set forth in the Operator/Driver Guidelines section below, as well as the instructions in any applicable sections of the Proterra Driver’s manual.

For any other types of driver’s dash display warning lights (including but not limited to solid, non-flashing red or yellow “warning” lights) and/or audible alarms, please refer to the vehicle owner’s manual for an explanation of these warnings and recommended actions.

Figure 1 below shows the Red Stop Lamp as presented on the original Proterra dash. Figure 2 below shows the Red Stop Lamp as presented on the updated Proterra digital dash.

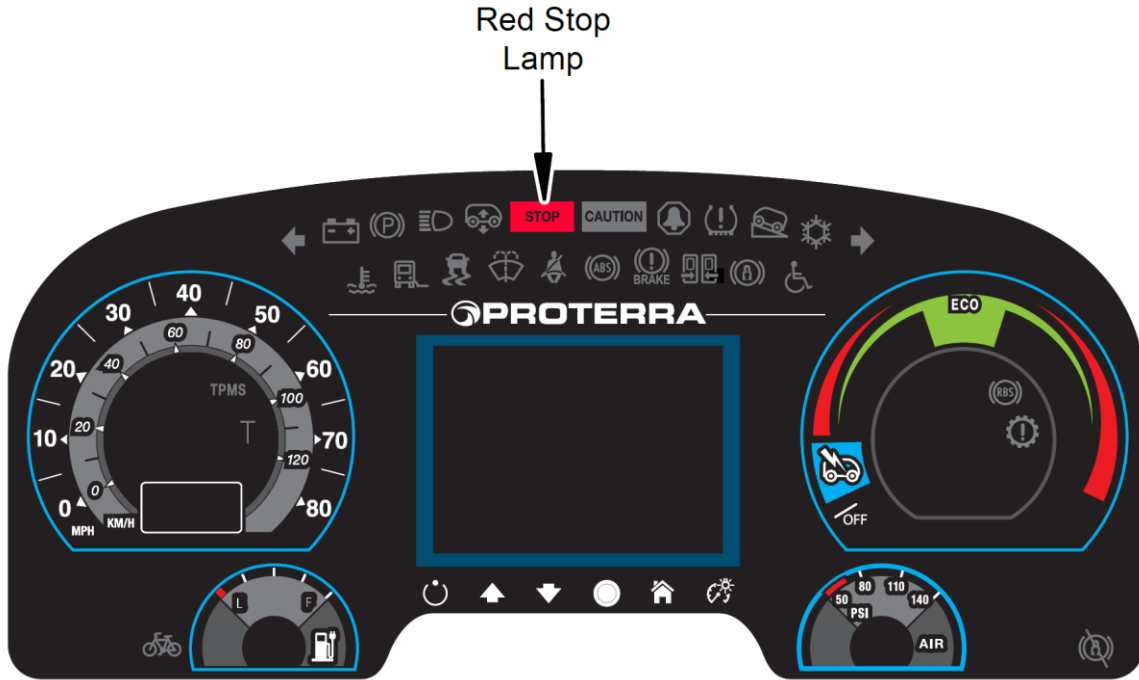

Figure 1 – Red Stop Lamp on Original Dash

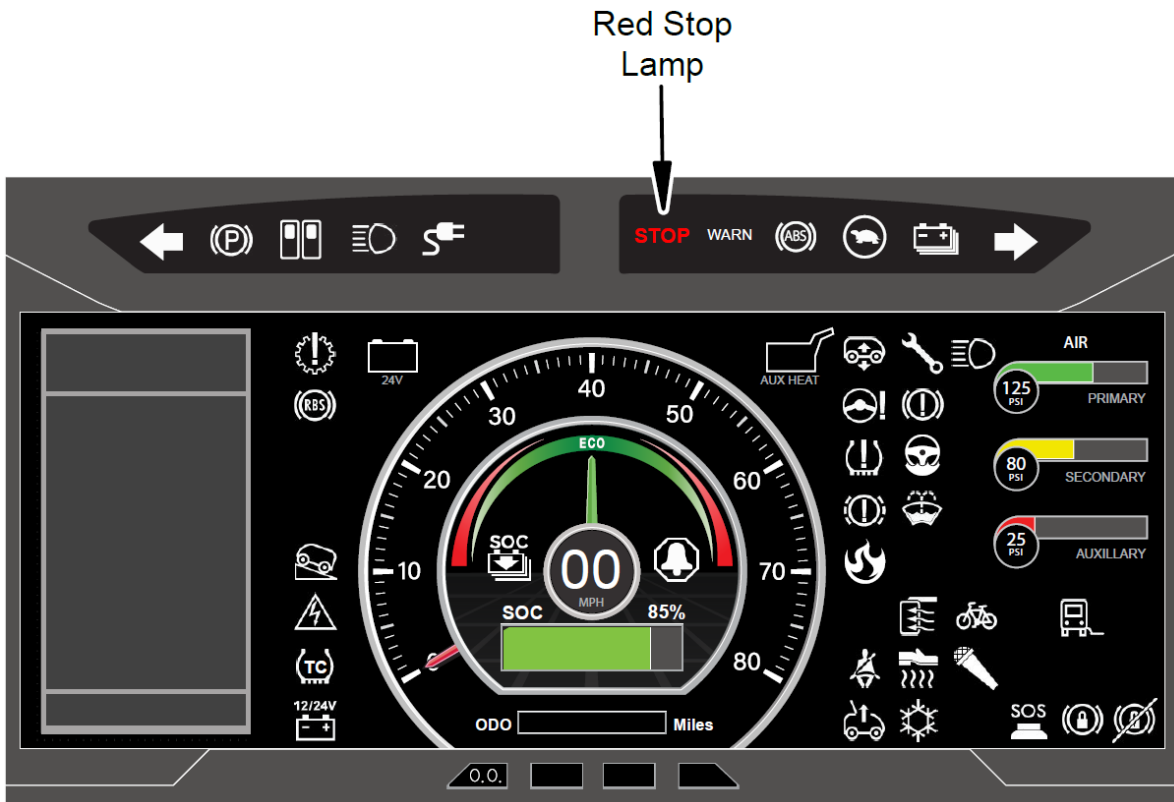

Figure 2 – Red Stop Lamp on Digital Dash

**OWNERS SHOULD ALWAYS MONITOR AND RESPOND TO DASH FAULT LIGHTS AS PART OF THE VEHICLE OPERATION AND MAINTENANCE ROUTINE. OWNERS MUST PERFORM FOLLOW-UP INVESTIGATION WHEN DASH FAULT LIGHTS PRESENT. DO NOT IGNORE A DASH FAULT LIGHT.**

In addition to the Critical Battery Fault Warnings, a critical battery fault will prevent the vehicle from charging and cause the vehicle to immediately enter a “limp home” state where the propulsion system is limited to 50 kW. The “limp home” state will provide enough power to launch the vehicle and maintain 35 mph on a flat road with an unloaded bus. In addition to the Critical Battery Fault Warnings, the Owner’s service technicians should be trained by Proterra in use of Proterra’s diagnostic tool to identify and detect abnormal battery conditions (see <https://www.proterra.com/proterra-diagnostics-tool/> to download the tool and access training material). The Owner’s consistent and routine use of the Proterra diagnostic tool is recommended to identify and monitor issues that may require further investigation.

## 4 OPERATOR/DRIVER GUIDELINES

---

Prior to operating the vehicle, the driver must perform all recommended safety checks set forth in the Proterra Driver's Manual. This inspection includes, but is not limited to, a visual inspection for signs of damage/malfunction and confirmation that the fault lights in the dashboard display are not illuminated.

If there are any signs of fire prior to operation or while the vehicle is in use (e.g., smoke, a burning smell, abnormal popping or whistling noises, a flame, etc.), the driver must immediately stop the vehicle in a safe location and evacuate all passengers in accordance with the emergency guidelines in Fire-Safety Guidelines for an EV Battery (Section 1). Note -- the vehicle may be in a "limp home" state with limited propulsion as described above.

If the Critical Battery Fault Warnings are active as described in Section 3.2 (but there is no smoke, burning smell, abnormal popping or whistling noises, flame, etc.), the vehicle should be promptly parked in a safe outdoor location at least 20 feet away from other objects such as buildings, trees and other vehicles, and at least 100 feet away from highly flammable items such as gas stations or propane tanks. Once the vehicle has been moved to a safe location, the operator and passengers may exit the vehicle and the vehicle should be removed from service.

The vehicle high voltage system may be left in either state; on or turned off. However, DO NOT open the 12/24 Master Disconnect Switch or Battery Saver Switch (if equipped). Keeping these switches closed will allow the battery coolant pumps to operate as intended to mitigate heat buildup as well as providing power to telemetry systems for remote data review.

### Next Steps

- Call the Proterra Regional Field Service Representative (FSR) as soon as possible to report the issue. Proterra will respond within 2 hours (Mon- Fri between 6 am-6pm ET) or by 9 AM ET the following business day.
- DO NOT attempt to charge the vehicle.
- Continue to monitor the vehicle for signs that there could be a thermal runaway (smoke, burning smell, abnormal popping or whistling noises, flame, etc.).
- DO NOT operate or work on the vehicle until Proterra's service personnel have had the opportunity to assess the situation and the parties have an agreed action plan.  
If there are any signs of a fire (e.g., smoke, a burning smell, abnormal popping or whistling noises, a flame, etc.), follow the emergency guidelines outlined in Fire-Safety Guidelines for an EV Battery (Section 1).

## 5 MONITORING BATTERIES WITH DIAGNOSTIC TOOL

---

The Proterra Diagnostic Tool (the "Diagnostic Tool") enables customers to monitor the humidity and isolation levels of a battery pack that may indicate a critical battery safety condition. These metrics are used by the software systems described above. **As part of a customer's routine maintenance program, the Diagnostic Tool should be used every *three months* to monitor the humidity and internal isolation levels of each battery pack as described below. If a vehicle has been turned off for three months or**

more, the customer must use the Diagnostic Tool to check each battery pack prior to starting, operating or charging the vehicle.

**Steps to Use Diagnostic Tool to Check Humidity and Internal Isolation of Battery Packs**

**Step 1:** Connect the Diagnostic tool to a vehicle diagnostic port that has BCAN access. NOTE: The diagnostic port location varies based on the vintage of the vehicle.

**Step 2:** View the “Battery Thermal” screen on the left-hand side. Example:

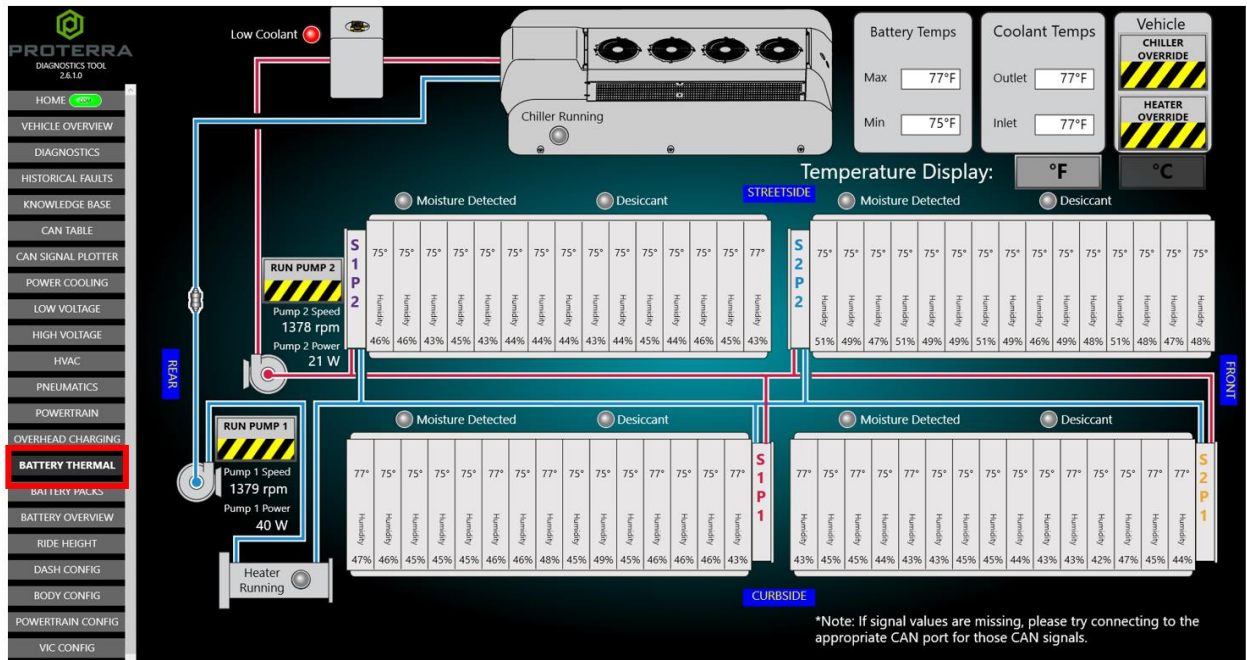

**Step 3:** View the humidity level of each module per battery pack; the pack ID is located on the graphic of the A-Bay. If the module humidity levels are less than 70%, the battery pack check is complete. If there is one or more module(s) that exceeds 70% humidity, you must proceed to the next step.

Example: S1P1, S1P2, S2P1 and S2P2 as shown below. NOTE: your screen and Pack ID may look different based on the vintage of vehicle.







**Step 5:** With the relevant Pack ID selected in the pulldown menu, the internal isolation value should be recorded.

PROTERRA  
DIAGNOSTICS TOOL  
2.6.1.0

HOME  VEHICLE OVERVIEW DIAGNOSTICS HISTORICAL FAULTS KNOWLEDGE BASE CAN TABLE CAN SIGNAL PLOTTER POWER COOLING LOW VOLTAGE HIGH VOLTAGE HVAC PNEUMATICS POWERTRAIN OVERHEAD CHARGING BATTERY THERMAL **BATTERY PACKS** BATTERY OVERVIEW RIDE HEIGHT DASH CONFIG BODY CONFIG POWERTRAIN CONFIG VIC CONFIG

Isolation Internal: **47640 kΩ** Temperature Display: °F °C STRING 2 PACK 2  
 Pack Voltage: 324.90 V Contactor  Moisture Detected   
 Pack Current: -13.80 A Reset Desiccant Alarm  
 Coolant Supply Temp: 50°F SC SW Ver: 152005C0  
 Coolant Return Temp: 50°F Main SW Ver: 152005C0

75°	75°	75°	75°	75°	75°	75°	75°	75°	75°	75°	75°	75°	75°	75°
3.586	3.586	3.585	3.586	3.585	3.585	3.585	3.585	3.585	3.586	3.585	3.585	3.586	3.585	3.585
3.586	3.587	3.586	3.586	3.586	3.586	3.585	3.585	3.585	3.586	3.585	3.586	3.585	3.585	3.585
3.585	3.586	3.585	3.585	3.585	3.583	3.585	3.585	3.585	3.586	3.585	3.585	3.586	3.585	3.583
3.585	3.586	3.586	3.586	3.585	3.585	3.586	3.585	3.585	3.585	3.585	3.586	3.585	3.583	3.586
3.585	3.586	3.586	3.586	3.586	3.586	3.585	3.585	3.585	3.586	3.585	3.586	3.585	3.586	3.586
3.584	3.585	3.585	3.585	3.584	3.585	3.585	3.583	3.585	3.585	3.585	3.585	3.585	3.586	3.585

\*Note: If signal values are missing, please try connecting to the appropriate CAN port for those CAN signals. \* All battery values are shown in volts

**Step 6:** If either of the following conditions are met, proceed to Step 7 below.

- a. Condition 1:
  - Humidity greater than 90%
- b. Condition 2:
  - Humidity greater than 70% AND
  - Internal Isolation less than 20,000 Kohms

If neither of these conditions are met, no issue has been found with respect to the recorded battery pack(s) humidity and internal isolation levels, and the battery pack check is complete.

**Step 7: If Condition 1 or 2 are present:**

The vehicle should be promptly parked in a safe outdoor location at least 20 feet away from other objects such as buildings, trees and other vehicles, and at least 100 feet away from highly flammable items such as gas stations or propane tanks. Once the vehicle has been moved to a safe location, the operator and passengers may exit the vehicle and the vehicle should be removed from service.

The vehicle high voltage system may be left in either state; on or turned off. However, DO NOT open the 12/24 Master Disconnect Switch or Battery Saver Switch (if equipped). Keeping these switches closed will allow the battery coolant pumps to operate as intended to mitigate heat buildup as well as providing power to telemetry systems for remote data review.

- Call the Proterra Regional Field Service Representative (FSR) as soon as possible to report the issue. Proterra will respond within 2 hours (Mon- Fri between 6 am-6pm ET) or by 9 AM ET the following business day.
- DO NOT attempt to charge the vehicle.
- Continue to monitor the vehicle for signs that there could be a thermal runaway (smoke, burning smell, abnormal popping or whistling noises, flame, etc.).
- DO NOT operate or work on the vehicle until Proterra's service personnel have had the opportunity to assess the situation and the parties have an agreed action plan.

If there are any signs of a fire (e.g., smoke, a burning smell, abnormal popping or whistling noises, a flame, etc.), follow the emergency guidelines outlined in Fire-Safety Guidelines for an EV Battery (Section 1).

# Proterra – 400V E2Ver1 Body and ESM Software Update (Service Campaign SC-23-126)

**NHTSA ID: 22V887**

IMPORTANT! This form MUST BE COMPLETED for each vehicle retrofitted.

(One (1) Claim Form per Vehicle)

Transit Agency: \_\_\_\_\_ Date Claim Completed: \_\_\_\_\_

Fleet Number: \_\_\_\_\_ VIN Number: \_\_\_\_\_

Vehicle Mileage: \_\_\_\_\_ Vehicle In-Service Date: \_\_\_\_\_

Completion Verification:

In signing this form, the signatory verifies that the Software Update has been completed and appropriate personnel at the transit agency have read and understand the Proterra EV Battery Fire Safety Guide provided with the Software Update service bulletin.

Print Name: \_\_\_\_\_

Signature: \_\_\_\_\_

REQUIRED: When this Verification Form has been completed, send to:

**Perry Bolick (Proterra Field Service)**  
**1 Whitlee Court, Greenville, SC 29607**  
**[pbolick@proterra.com](mailto:pbolick@proterra.com) (864) 243-7572**  
**Include in the email Subject line: 22V887 Completion**