



Safety Recall

Code: 93O2

REVISION

Subject Flexible Printed Circuit Solder – HV Battery

Release Date December 23, 2022

REVISION SUMMARY Updated work instructions and SVM information. Service Action 97FY no longer has to be performed before completing the 93O2 repair.

Affected Vehicles

Country	Beginning Model Year	Ending Model Year	Vehicle	Vehicle Count
USA	2021	2021	ID4	356
CAN	2021	2022	ID4	6

Check Campaigns/Actions screen in ELSA on the day of repair to verify that a VIN qualifies for repair under this action. ELSA is the only valid campaign inquiry & verification source.

- ✓ Campaign status must show “open.”
- ✓ If ELSA shows other open action(s), inform your customer so that the work can also be completed at the same time the vehicle is in the workshop for this campaign.

Problem Description Specific soldering points on the flexible printed circuit assembled (FPCA) inside the HV battery may not establish a reliable connection due to manufacturing issues. Unreliable connections inside the HV battery may lead to breakdowns or stalling while driving in the field. This can lead to a crash without warning.

Corrective Action Replace the affected battery cell modules.

Precautions If the recall issue is present in the vehicle, the driver would be alerted by a message appearing in the instrument panel warning about an issue in the high voltage system. Should this occur, customers are advised to contact an authorized Volkswagen dealer without delay to make arrangements to have the vehicle diagnosed/repared.

Code Visibility On April 08, 2022, the campaign code was applied to affected vehicles.

Owner Notification Owner notification will take place in December 2022. Owner letter examples are included in this bulletin for your reference.

Additional Information Please alert everyone in your dealership about this action, including Sales, Service, Parts and Accounting personnel. Contact Warranty if you have any questions.

IMPORTANT REMINDER ON VEHICLES AFFECTED BY SAFETY & COMPLIANCE RECALL:

New Vehicles in Dealer Inventory: It is a violation of federal law for a dealer to deliver a new motor vehicle or any new or used item of motor vehicle equipment (including a tire) covered by this notification under a sale or lease until the defect or noncompliance is remedied. By law, dealers must correct, prior to delivery for sale or lease, any vehicle

The repair information in this document is intended for use only by skilled technicians who have the proper tools, equipment and training to correctly and safely maintain your vehicle. These procedures are not intended to be attempted by “do-it-yourselfers,” and you should not assume this document applies to your vehicle, or that your vehicle has the condition described. To determine whether this information applies, contact an authorized Volkswagen dealer. ©2022 Volkswagen Group of America, Inc. and Volkswagen Canada. All Rights Reserved.

that fails to comply with an applicable Federal Motor Vehicle Safety Standard or that contains a defect relating to motor vehicle safety.

Pre-Owned Vehicles in Dealer Inventory: Dealers should not deliver any pre-owned vehicles in their inventory which are involved in a safety or compliance recall until the defect has been remedied.

Dealers must ensure that every affected inventory vehicle has this campaign completed before delivery to consumers.

Fill out and affix Campaign Completion Label (CAMP 010 000) after work is complete. *Labels can be ordered at no cost via the Compliance Label Ordering portal at www.vwhub.com.*

Parts Information

Parts Control Type: VIN to Order	If parts are needed to support a vehicle repair: <ul style="list-style-type: none"> • US Dealers - use AVA • CAN Dealers - contact the Parts Specialists via phone (800-767-6552), email (VWoAPartsSpecialists@vw.com), or chat/text with the VIN to order
---	--

Parts Control Type: Free Order	Parts will be managed by Free Order
---	-------------------------------------

Initial Allocation: NO	There will be no parts allocation. Please reference the Repair Projection Tool (below) to view your potential VIN population.
---	---

Repair Projection Tool: (right click to open)	
--	---

Criteria	Quantity	Part Number	P.O.C. Part Description	Ordering Method
04	1	0Z1-915-599-H	CELL MOD.	VIN to Order
05	2			
04 or 05	4 per cell module	N -912-809-01	SCREW	Free Order
	1 per cell module	D -G00-018-M2	PASTE	
	1 per cell module	0Z1-998-474	SEP. FILM	
	1	D -316-000-A1	UNDER COAT	
	1	D -454-300-H2	SEALANT	VIN to Order
	1	11A-998-844	Parts Kit	
	As needed	G -12E-100-1L DSP	G12 EVO Coolant Concentrate	Free Order

NOTE

The specified part numbers reflect the status at the start of this action. Interim updates made in ETKA can cause a listed part number to become unavailable. In this case, the new part number specified in ETKA should be used.

Claim Entry Instructions

The labor times listed here may differ from the labor operations and labor times listed in ELSA.

After campaign has been completed, enter claim as soon as possible to help prevent work from being duplicated elsewhere. Attach the ELSA screen print showing action open on the day of repair to the repair order.

If customer refused campaign work:

- ✓ U.S. dealers: Submit request via WISE under the *Campaigns/Update/Recall Closure* option.
- ✓ Canada dealers: Upload the repair order [signed by customer] to Volkswagen WIN/Operations/Campaign Closure.

Service Number	9302		
Damage Code	0099		
Parts Vendor Code	WWO		
Claim Type	Sold vehicle: 7 10 Unsold vehicle: 7 90		
Causal Indicator	Mark CELL MOD* as causal part		
Vehicle Wash/Loaner	<p>Do not claim wash/loaner under this action</p> <p>U.S.A.: Loaner/rental coverage cannot be claimed under this action. However, loaner/rental may be covered under the Alternate Transportation Program. Please refer to the Volkswagen Warranty Policy and Procedures Manual for loaner claims information and reimbursement details.</p> <p>Canada: Loaner/rental coverage cannot be claimed under this action. Please refer to Volkswagen Service Loaner Program to determine loaner eligibility.</p>		
Criteria I.D.	04		
	Replace one cell module according to the affected serial number list		
	LABOR		
	Labor Op	Time Units	Description
	9301 55 99	635	Replace one cell module
	9305 01 99	10	Check and measure HV battery cover (if necessary)
	9329 01 99	120	Clean HV battery cover (if HV battery cover is reused)
	2706 89 50	10	Connect battery charger (if necessary)
	0150 00 00	Time stated on diagnostic protocol	All GFF Operations
	<i>NOTE: Multiple GFF logs can be added together</i>		

Continued on next page

PARTS		
Quantity	Part Number	Description
1.00	0Z1915599H	CELL MOD*
4.00	N 91280901	SCREW
1.00	D G00018M2	PASTE
1.00	0Z1998474	SEP. FILM
1.00	D 316000A1	UNDER COAT
1.00	D 454300H2	SEALANT
1.00	11A998844	Parts Kit
Up to 20.00	G 12E100S0	COOLANT CONCENTRATE
1.00	1EA804841AC	HV battery cover (if HV battery cover required replacement)
Criteria I.D.	05	
Replace two cell modules according to the affected serial number list		
LABOR		
Labor Op	Time Units	Description
9301 56 99	815	Replace two cell modules
9305 01 99	10	Check and measure HV battery cover (if necessary)
9329 01 99	120	Clean HV battery cover (if HV battery cover is reused)
2706 89 50	10	Connect battery charger (if necessary)
0150 00 00	Time stated on diagnostic protocol	All GFF Operations
<i>NOTE: Multiple GFF logs can be added together</i>		
PARTS		
Quantity	Part Number	Description
2.00	0Z1915599H	CELL MOD.
8.00	N 91280901	SCREW
2.00	D G00018M2	PASTE
2.00	0Z1998474	SEP. FILM
1.00	D 316000A1	UNDER COAT
1.00	D 454300H2	SEALANT
1.00	11A998844	Parts Kit
Up to 20.00	G 12E100S0	COOLANT CONCENTRATE
1.00	1EA804841AC	HV battery cover (if HV battery cover required replacement)

Continued on next page

	<p>Add the following for each additional cell module being replaced due to results from cell module equalization test plan.</p> <p><i>EXAMPLE: A criteria 04 vehicle also requires 2 <u>additional</u> cell modules replaced as directed by the test plan:</i></p> <ul style="list-style-type: none"> You will combine the total quantity of parts replaced (i.e. 3.00 cell modules, 12.00 screws, etc.) For the two <u>additional</u> cell modules, you will claim a single labor operation of 360 TU under LO 9301 19 99 		
	LABOR		
	Labor Op	Time Units	Description
	9301 19 99	180 <i>(per additional cell module)</i>	Battery module remove+reinstall
	PARTS		
	Quantity	Part Number	Description
	1.00	0Z1915599H	CELL MOD.
	4.00	N 91280901	SCREW
	1.00	D G00018M2	PASTE
	1.00	0Z1998474	SEP. FILM
	Add the following if the cell module equalization test plan identified a module with increased self-discharge		
	LABOR		
	Labor Op	Time Units	Description
	N/A	Time stated on diagnostic protocol	Reset balancing time counters via SVM and carry out necessary test plans (if an additional module required replacement)
	<p><i>All GFF operations will be claimed under ONE labor operation. The time it takes to complete the additional SVM and test plans will be accounted for under labor operation 0150 00 00, which is outlined in the Criteria 04 and 05 claiming instructions. DO NOT enter the labor operation more than once. Add all GFF operations/logs together and claim them once.</i></p>		
	9668 25 99	25	Perform bus sleep (if an additional module required replacement)

	The following can be added as needed in the event of breakage during the repair.		
	PARTS		
	Quantity	Part Number	Description
	As required	WHT003491	NUT
	As required	WHT009733	BOLT
	As required	8E0825267	PUSH PIN
	As required	N 0385494	RIVET

Customer Letter Example (USA)

<MONTH YEAR>

<CUSTOMER NAME>

<CUSTOMER ADDRESS>

<CUSTOMER CITY STATE ZIPCODE>

This notice applies to your vehicle: <MODEL YEAR> <BRAND> <CARLINE>, <VIN>

NHTSA: 22V162

Subject: Safety Recall 9302 - Flexible Printed Circuit Solder – HV Battery

Dear Volkswagen Owner,

This notice is sent to you in accordance with the National Traffic and Motor Vehicle Safety Act. Volkswagen has decided that a defect, which relates to motor vehicle safety, exists in certain 2021 model year Volkswagen ID.4 vehicles. Our records show that you are the owner of a vehicle affected by this action.

What is the issue? Specific soldering points on the flexible printed circuit assembled (FPCA) inside the HV battery may not establish a reliable connection due to manufacturing issues. Unreliable connections inside the HV battery may lead to breakdowns or stalling while driving in the field. This can lead to a crash without warning.

What will we do? To correct this defect, your authorized Volkswagen dealer will replace the affected battery cell modules. This work will take at least one day to complete and will be performed for you free of charge. Please keep in mind that your dealer may need additional time for the preparation of the repair, as well as to accommodate their daily workshop schedule.

What should you do? Please contact your authorized Volkswagen dealer without delay to schedule this recall work. To set up an appointment online, please visit www.vw.com/find-a-dealer.

Precautions you should take If the recall issue is present in the vehicle, the driver would be alerted by a message appearing in the instrument panel warning about an issue in the high voltage system. Should this occur, customers are advised to contact an authorized Volkswagen dealer without delay to make arrangements to have the vehicle diagnosed/repaired.

Lease vehicles and address changes If you are the lessor and registered owner of the vehicle identified in this action, the law requires you to forward this letter immediately via first-class mail to the lessee within ten (10) days of receipt. If you have changed your address or sold the vehicle, please fill out the enclosed prepaid Owner Reply card and mail it to us so we can update our records.

Can we assist you further? If your authorized Volkswagen dealer fails or is unable to complete this work free of charge within a reasonable time, or if you should have any questions about this communication, please reach out to us using your preferred method of communication at www.vw.com/contact or by calling us at 800-893-5298.

Checking your vehicle for open Recalls and Service Campaigns To check your vehicle's eligibility for repair under this or any other recall/service campaign, please visit www.vw.com/owners/recalls and enter your Vehicle Identification Number (VIN) into the Recall/Service Campaign Lookup tool.

If you still cannot obtain satisfaction, you may file a complaint with: The Administrator, National Highway Traffic Safety Administration, 1200 New Jersey Avenue, SE., Washington, DC 20590; or call the toll-free Vehicle Safety Hotline at 1-888-327-4236 (TTY: 1-800-424-9153); or go to <http://www.safercar.gov>.

We apologize for any inconvenience this matter may cause; however we are taking this action to help ensure your safety and continued satisfaction with your vehicle.

Sincerely,

Volkswagen Customer Protection

The repair information in this document is intended for use only by skilled technicians who have the proper tools, equipment and training to correctly and safely maintain your vehicle. These procedures are not intended to be attempted by "do-it-yourselfers," and you should not assume this document applies to your vehicle, or that your vehicle has the condition described. To determine whether this information applies, contact an authorized Volkswagen dealer. ©2022 Volkswagen Group of America, Inc. and Volkswagen Canada. All Rights Reserved.

Customer Letter Example (Canada)

<MONTH YEAR>

<CUSTOMER NAME>

<CUSTOMER ADDRESS>

<CUSTOMER CITY STATE ZIPCODE>

This notice applies to your vehicle: <MODEL YEAR> <BRAND> <CARLINE>, <VIN>

Transport Canada Recall: 2022-123

Subject: Safety Recall 93O2 - Flexible Printed Circuit Solder – HV Battery

Dear Volkswagen Owner,

This notice is sent to you in accordance with the requirements of the *Motor Vehicle Safety Act*. This is to inform you that your vehicle may contain a defect that could affect the safety of a person. Our records show that you are the owner of a vehicle affected by this action.

What is the issue? Specific soldering points on the flexible printed circuit assembled (FPCA) inside the HV battery may not establish a reliable connection due to manufacturing issues. Unreliable connections inside the HV battery may lead to breakdowns or stalling while driving in the field. This can lead to a crash without warning.

What will we do? To correct this defect, your authorized Volkswagen dealer will replace the affected battery cell modules. This work will take at least one day to complete and will be performed for you free of charge. Please keep in mind that your dealer may need additional time for the preparation of the repair, as well as to accommodate their daily workshop schedule.

What should you do? Please contact your authorized Volkswagen dealer without delay to schedule this recall work.

Precautions you should take If the recall issue is present in the vehicle, the driver would be alerted by a message appearing in the instrument panel warning about an issue in the high voltage system. Should this occur, customers are advised to contact an authorized Volkswagen dealer without delay to make arrangements to have the vehicle diagnosed/repaired.

Lease vehicles and address changes If you are the lessor and registered owner of the vehicle identified in this letter, you shall forward this letter (and any subsequent notice, if applicable) to the lessee within ten (10) days of receipt. If you have changed your address or sold the vehicle identified in this letter, please fill out the enclosed prepaid Owner Reply Card and mail it to us so we can update our records.

Can we assist you further? If your authorized Volkswagen dealer fails or is unable to complete this work free of charge within a reasonable time, please contact Customer Relations, Monday through Friday from 8AM to 8PM EST by phone at 1-800-822-8987 or via our "Contact Us" page at www.vw.ca.

We apologize for any inconvenience this matter may cause; however we are taking this action to help ensure your safety and continued satisfaction with your vehicle.

Sincerely,

Volkswagen Customer Protection

Safety Precautions When Working ON the High-voltage System (additional information is also available in the ELSA Repair Manual)

DANGER

Extremely dangerous due to high voltage.

- The high-voltage system is under heavy voltage. Severe bodily injury or death by electrocution or electric arcs is possible.
- When working on the high-voltage system the high-voltage system must be de-energized.
- When performing procedures that do not directly affect the high-voltage system, in some cases it is still necessary to de-energize the high-voltage system.
- Pay attention when the high-voltage system must be de-energized. Refer to the Repair Manual
- Have a High-Voltage Technician or a High-Voltage Expert de-energize the high-voltage system.

The electric and magnetic fields are extremely dangerous.

- There are electric and magnetic fields on the high-voltage system. Death or serious injury are possible due to malfunction of active implants (for example cardiac pacemakers, insulin pumps).
- Persons with active implants may not perform procedures on the high-voltage system.

WARNING

Risk of injury - motor may start unexpectedly

It is difficult to determine whether the drive system of an electric vehicle or hybrid vehicle is active. Moving parts can trap or draw in parts of the body.

CAUTION

Risk of damage to high-voltage wiring

- Incorrect handling may result in damage to the insulation of high-voltage wires or high-voltage connectors.
- Do not support yourself on high-voltage cables or connectors.
- Never prop tools against high-voltage wiring or high-voltage connectors.
- Never bend or kink high-voltage wiring.
- Observe the coding of the high-voltage connectors when joining them up.

Safety Precautions When Working NEAR the High-voltage System (additional information is also available in the ELSA Repair Manual)

DANGER

Extremely dangerous due to high voltage.

- The voltage levels in the high-voltage system constitute a safety hazard. Danger of severe or fatal injuries from electric shock if high-voltage components or high-voltage wiring are damaged.
- Carry out a visual check of high-voltage components and high-voltage wiring.
- Never use cutting/forming tools or other sharp-edged implements.
- Never perform work using welding, brazing, thermal bonding or hot air in the area of high-voltage components and high-voltage cables.

 **DANGER**

High voltage increases the risk of fatal injury

Electrocution can cause severe bodily or fatal injury.

- For the following procedures suitable personal protective equipment must be worn.
- For the following steps two correspondingly qualified technicians must be present for the supervision.
- If necessary, a second technician can help the high-voltage expert outside of the hazardous area within their qualification.
- The personal protective equipment (PPE) must be dry and undamaged.

Repair Overview

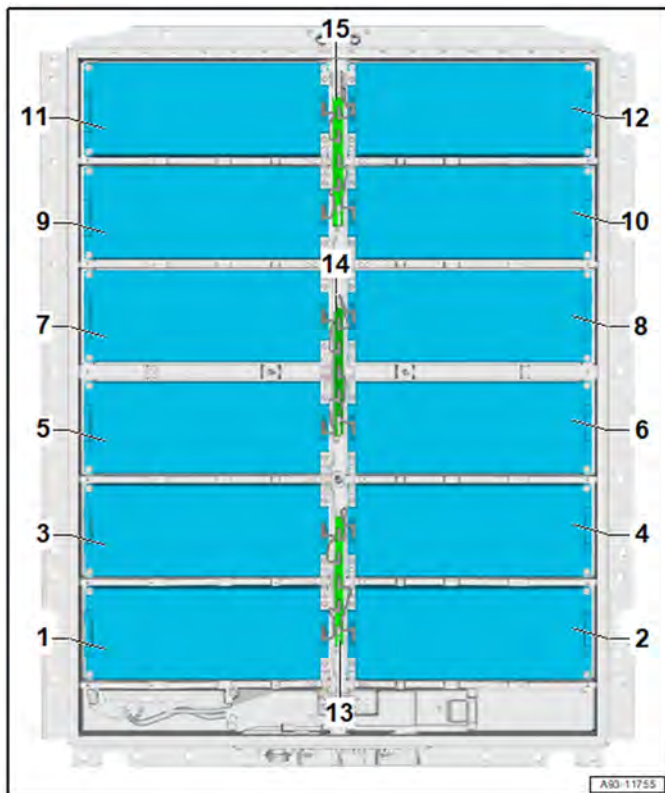

- **All vehicles** – perform a test plan to check for cell modules with an increased self-discharge. If a module is identified by the test plan as needing replacement, it will be replaced while the HV battery is open.
- **Criteria 04 vehicles** - replace one, pre-identified, cell module inside the high voltage battery.
- **Criteria 05 vehicles** - replace two, pre-identified, cell modules inside the high voltage battery.



NOTE

There are three Criteria 04 VINs that have additional pre-identified cell modules. These VINs are included in a future campaign. All of the pre-identified cell modules should be replaced under this action.

NOTE

- These repair instructions may differ from the labor operations and labor times listed in ELSA.
- Damages resulting from improper repair or failure to follow these work instructions are the dealer's responsibility and are not eligible for reimbursement under this action.
- This procedure must be read in its entirety prior to performing the repair.
- Due to variations in vehicle equipment and options, the steps/illustrations in this work procedure may not identically match all affected vehicles.
- Diagnosis and repair of pre-existing conditions in the vehicle are not covered under this action.
- When working during extreme temperatures, it is recommended that the vehicle be allowed to acclimate inside the shop to avoid temperature-related component damage/breakage.

Required Tools

	<p>Engine Support Set -10-222B- (MRT)</p>		<p>Adapter -10-222A/14- (MRT)</p>
	<p>Module Lifting Aid -T10619- (MRT)</p>		<p>Lifting Tackle -3033- (MRT)</p>
	<p>Shock-Proof Protection (30 Pcs) -T10608- (MRT)</p>		<p>Shock-Proof Protection -T10628- (MRT)</p>
	<p>Removal Wedge Set -VAS895015- (MRT)</p>		<p>Engine Support - Bracket w/Spindle and hook -10-222A/10- (MRT)</p>
	<p>Shop Crane -VAS6100- (or equivalent)</p>		<p>Insulating Mat -VAS6762/44- (MRT)</p>









The repair information in this document is intended for use only by skilled technicians who have the proper tools, equipment and training to correctly and safely maintain your vehicle. These procedures are not intended to be attempted by "do-it-yourselfers," and you should not assume this document applies to your vehicle, or that your vehicle has the condition described. To determine whether this information applies, contact an authorized Volkswagen dealer. ©2022 Volkswagen Group of America, Inc. and Volkswagen Canada. All Rights Reserved.

	<p>Scissor Lift Table -VAS6131B- (or equivalent)</p>		<p>Engine Bung Set -VAS6122- (or equivalent)</p>
	<p>Leak-tight Connector -T10607- (MRT)</p>		<p>Pressure and Vacuum Pump -VAS671005- (MRT)</p>
	<p>Digital Pressure Sensor -VAG1397B- (MRT)</p>		<p>High Voltage Tool Set – Screwdriver -VAS6762/34-</p>
	<p>Cooling System Tester - Directional Valve -VAS691005/1- (component of MRT -VAS691005-)</p>		<p>High Voltage Tool Set - Torque Wrench -VAS6883/1A- (MRT)</p>
	<p>High Voltage Tool Set - Voltage Tester -VAS6762/45- (MRT)</p>		<p>Cooling System Tester - Directional Valve -VAS691005/5- (component of MRT -VAS691005-)</p>
	<p>Template -T10606-</p>		<p>Cooling System Charge Kit -VAS6096- (MRT)</p>

The repair information in this document is intended for use only by skilled technicians who have the proper tools, equipment and training to correctly and safely maintain your vehicle. These procedures are not intended to be attempted by "do-it-yourselfers," and you should not assume this document applies to your vehicle, or that your vehicle has the condition described. To determine whether this information applies, contact an authorized Volkswagen dealer. ©2022 Volkswagen Group of America, Inc. and Volkswagen Canada. All Rights Reserved.

 <p>B/1</p>	<p>Cooling System Tester -VAG1274B- (MRT)</p>		<p>Hose Clamps - Up To 25mm -3094- (or equivalent)</p>
	<p>Module Balancer -VAS6910- (MRT)</p>		<p>Insulating Mat -VAS6910/21-3- (MRT)</p>
	<p>Protective Cover -VAS6910/21-1- (component of MRT -VAS6910/21-)</p>		<p>Vehicle Diagnosis System - Connection Lead -VAS5051/66- (MRT)</p>
	<p>Pressure Sensor -VAS611013- (MRT)</p>		<p>Insulated Torx Wrench Set - 3/8 -VAS691003A- (MRT)</p>
	<p>*Extension Cables for High-Voltage Battery -VAS671007- (MRT)</p>		<p>*High Voltage Diagnostics Box -VAS5581A- (MRT)</p>
<p><i>*NOTE: Either -VAS671007- or -VAS5581A- may be used for this repair.</i></p>			

The repair information in this document is intended for use only by skilled technicians who have the proper tools, equipment and training to correctly and safely maintain your vehicle. These procedures are not intended to be attempted by "do-it-yourselfers," and you should not assume this document applies to your vehicle, or that your vehicle has the condition described. To determine whether this information applies, contact an authorized Volkswagen dealer. ©2022 Volkswagen Group of America, Inc. and Volkswagen Canada. All Rights Reserved.

	<p>High Voltage Test Adapter (without AFeS) -VAS6558A/35- (MRT)</p>		<p>High Voltage Tool Set – Reversible Ratchet 3/8" -VAS6762/29- (MRT)</p>
	<p>High Voltage Tool Set – Extension 140mm -VAS6762/31- (MRT)</p>		<p>Shackle (Equivalent to VAS691009A) -VAS691009US- Qty. = 8 (MRT)</p>
	<p>Diagnostic Tester -VAS6150X/6160X- (or equivalent)</p>		<p>Battery Tester/Charger capable of minimum 70 Amp continuous supply</p>
	<p>Double Cartridge Adhesive Gun -VAS5237-</p>		<p>High Voltage Tool Set – Screwdriver Insert XZN M10 -VAS6762/27-</p>

The repair information in this document is intended for use only by skilled technicians who have the proper tools, equipment and training to correctly and safely maintain your vehicle. These procedures are not intended to be attempted by "do-it-yourselfers," and you should not assume this document applies to your vehicle, or that your vehicle has the condition described. To determine whether this information applies, contact an authorized Volkswagen dealer. ©2022 Volkswagen Group of America, Inc. and Volkswagen Canada. All Rights Reserved.

Required Shop Materials



Cleaner D -009-401-04
(shop supply)

-OR-

91% Isopropyl Alcohol
(locally sourced)



Lint Free Towels
(locally sourced)

NOTE: Use only 91% Isopropyl alcohol as a cleaner (9% water). Do not use Isopropyl with any additional surfactants (cleaners) or additives (scents).

Repair Instruction

Section A - Check for Previous Repair

TIP

If Campaign Completion label is present, no further work is required.

Applicable criteria ID(s)	Campaign/Action Status
01 	Open 

EXAMPLE

Campaign/Action	Start	Designation
	2015-11-10	W-SERV_ACT -
	2018-12-13	RECALL -
	2017-05-16	A-RECALL -

EXAMPLE

- Enter the VIN in Elsa and proceed to the “Campaign/Action” screen.

TIP

On the date of repair, print this screen and keep a copy with the repair order.

- Confirm the Campaign/Action is open <arrow 1>. If the status is closed, no further work is required.
- Note the Applicable Criteria ID <arrow 2> for use in determining the correct work to be done and corresponding parts associated.
- **Proceed to Section B.**

NOTE

If the 93O2 is open in ELSA and ELSA service history shows a previous cell module replacement, please create a TAC WEB ticket and wait for further instructions before proceeding with this repair.

Section B – Replacing High-Voltage Battery Cell Module(s)

NOTE

Vehicles affected by the 93O2 have a cell module with faulty soldering connection to a measuring cable. The serial numbers of these modules have been identified and must be replaced.

Additionally, there is a possibility there are modules in the high-voltage battery that exhibit an increased self-discharge. These modules can be identified with a test plan, and must also be replaced.

Identify cell module which requires replacement:

- Use the chart found in one of the 93O2 attachment tabs in ELSA or in ServiceNet to determine the serial number of the module that requires replacement for the VIN you're working on.

NOTE

There are three Criteria 04 VINs that have additional pre-identified cell modules. These VINs are included in a future campaign. All of the pre-identified cell modules should be replaced under this action.

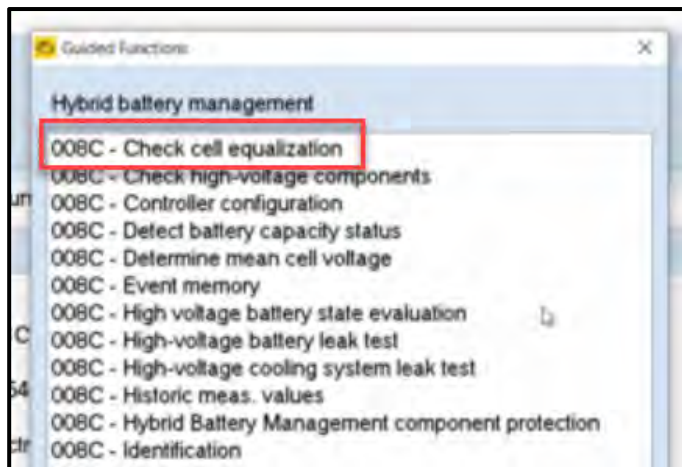

Check cell balancing and determine if additional modules require replacement:

- Perform a diagnostic scan of the vehicle.
- Select the 008C Guided Functions test plan:
 - 008C – Check cell equalization
- Follow the test plan steps. The test plan will identify which (if any) additional cell module(s) will require replacement due to increased self-discharge.
- If additional cell modules require replacements, place the order for the additional parts and continue with this procedure once all parts have arrived.

NOTE

If a module is replaced due to increased self-discharge, the balancing time counters must also be reset after the repair is complete. This is outlined in Section C.

If no additional cell modules require replacement, the balancing time counters DO NOT have to be reset.

- If no additional cell modules require replacement and all parts are available to complete this repair, continue with the next steps.

NOTE

It is possible that a cell module that requires replacement under the 9302 (the serial # has already been identified), is the same module that failed the cell balancing test.

Measurement name	ID	Value
minimum voltage for battery cells	IDE08218	
Value	MAS02985	
Index 1	MAS01234	31
maximum voltage for battery cells	IDE08217	
Value	MAS02985	
Index 1	MAS01234	

Perform cell balancing on new cell module:

- Check Measured Value Block (MVB) “maximum voltage for battery cells, IDE08217.
- The voltage reading listed will be entered in the DSS Manager program when balancing the new cell module.



- Follow the VAS6910 operating instructions in conjunction with the DSS Manager program to perform the cell balancing on the new cell module.

TIP

Operating instructions for the VAS6910 and DSS Manager program can be found on the VW Special Tools and Equipment website.



Status	Tests (sorted according to chances of success)
🚫	008C - High-voltage cooling system leak test
🚫	008C - Controller configuration
✅	008C - High-voltage battery leak test
✅	High-voltage system, de-energize
🚫	HV measurement module VAS6558/VAS6558A
✅	008C - Measuring values
🚫	008C - Identification
✅	008C - Event memory

Populate Guided Functions test plans:

- Perform a diagnostic scan of the vehicle.
- Select “Self Test” and populate the following Guided Function test plans:
 - High-voltage system, de-energize
 - 008C – High-voltage battery leak test
 - HV measurement module VAS6558/6558A

Tests in current test plan	
Status	Tests (sorted according to chances of success)
	008C - High-voltage cooling system leak test
	008C - Controller configuration
	008C - High-voltage battery leak test
	High-voltage system, de-energize
	HV measurement module VAS6558/VAS6558A
	008C - Measuring values
	008C - Identification
	008C - Event memory

De-energize the high-voltage system:

DANGER

High voltage increases the risk of fatal injury
Electrocution can cause severe bodily or fatal injury

Have a high-voltage technician or a high-voltage expert de-energize the high-voltage system.

- Follow the Guided Functions test plan steps.
- Pay close attention to all of the test plan steps.

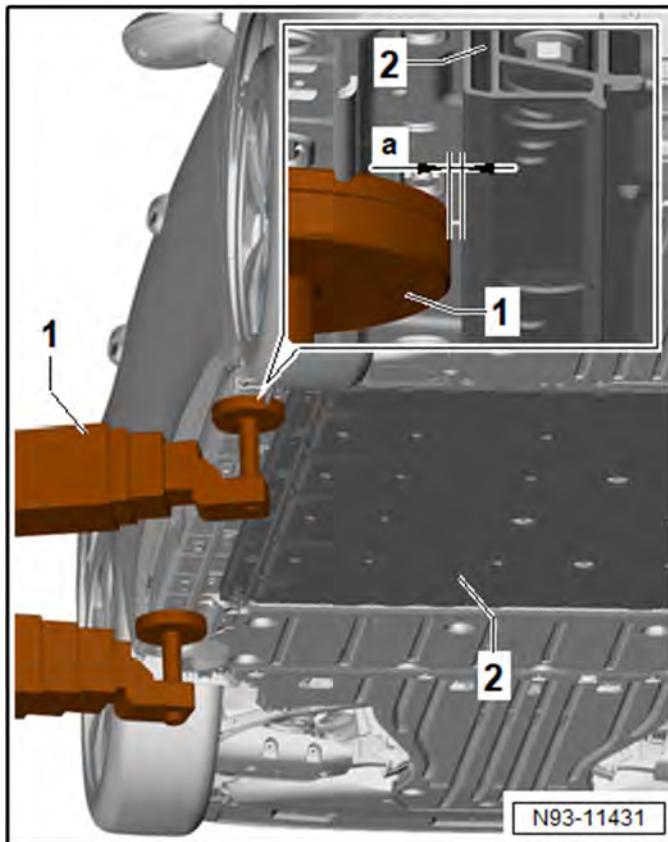

Raise the vehicle:

TIP

Removal of the high-voltage battery is not possible on all hoists. Make sure that there is enough clearance. Pay attention that the high-voltage battery has enough clearance <a> during the lifting process so that the Scissor Lift Table -VAS6131B- can be set down.

- Pivot in the hoist with the vehicle support plate <1> on the frame of the high-voltage battery <2>. Then pivot back the hoist arm with the vehicle support plate <1> <a> so that the high-voltage battery <2> can be lowered in the next steps.

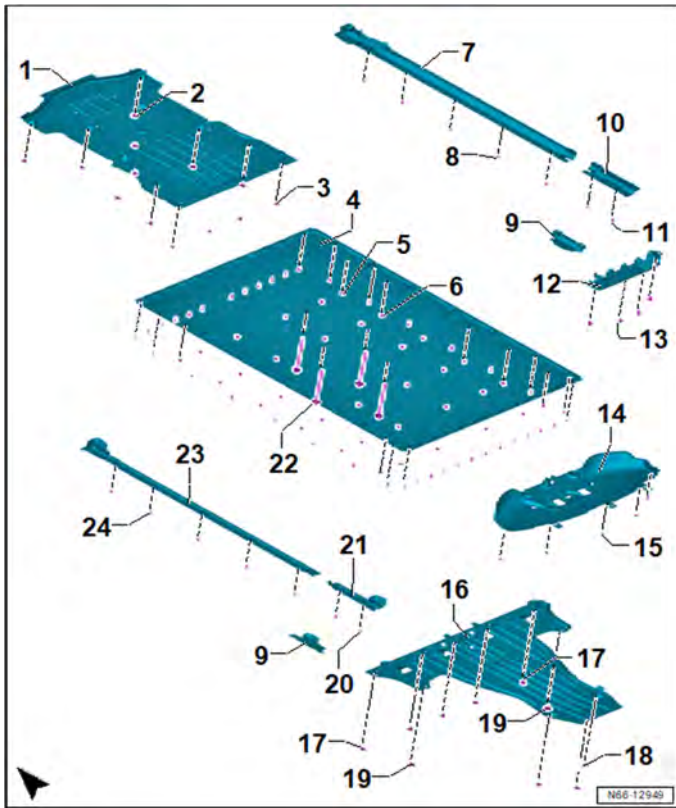

Remove lower covers:

- Reference ELSA Repair Manual.
- Remove the front underbody trim panel <1>. Refer to → *Body Exterior; Rep. Gr.66; Underbody Trim Panel; Front Underbody Trim Panel, Removing and Installing*.
- Front wheel housing liner, loosening in the area of the high-voltage battery threaded connection. Refer to → *Body Exterior; Rep. Gr.66; Wheel Housing Liner; Front Wheel Housing Liner, Removing and Installing*.
- Remove the side underbody trim panels. Refer to → *Body Exterior; Rep. Gr.66; Underbody Trim Panel; Side Underbody Trim Panel, Removing and Installing*.
- Remove the rear center underbody trim panel <16>. Refer to → *Body Exterior; Rep. Gr.66; Underbody Trim Panel; Rear Center Underbody Trim Panel, Removing and Installing*.
- Remove the rear underbody trim panel <14>. Refer to → *Body Exterior; Rep. Gr.66; Underbody Trim Panel; Rear Underbody Trim Panel, Removing and Installing*

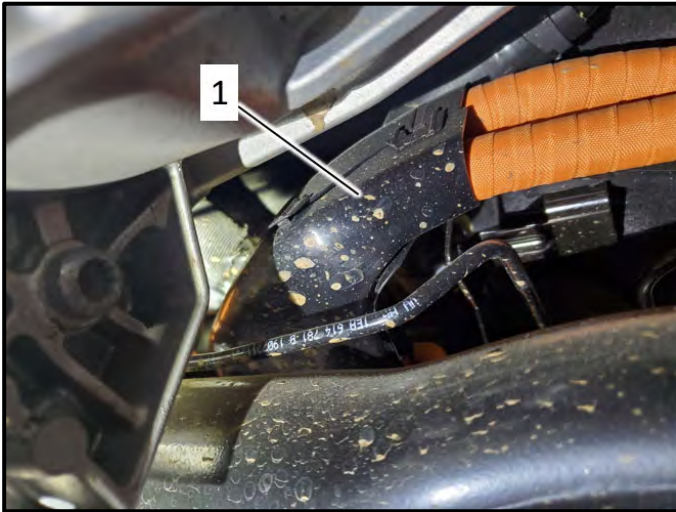

Perform high-voltage battery leak test:

- Before disconnecting the high-voltage battery connectors, remove the protective covers <1> from both of the connectors first.

Tests in current test plan	
Status	Tests (sorted according to chances of success)
	008C - High-voltage cooling system leak test
	008C - Controller configuration
	008C - High-voltage battery leak test
	High-voltage system, de-energize
	HV measurement module VAS6558/VAS6558A
	008C - Measuring values
	008C - Identification
	008C - Event memory

- See ELSA Repair Manual: *Repair Manual > Motor > Electric Drive Rear Wheel Drive EIP220 and All Wheel Drive EIA200, EIP220 > 93 Electric drive > High-Voltage Battery Unit > High-Voltage Battery 1 AX2 Leak Test*
- Perform these steps in conjunction with Guided Function test plan, “008C – High-voltage battery leak test.”

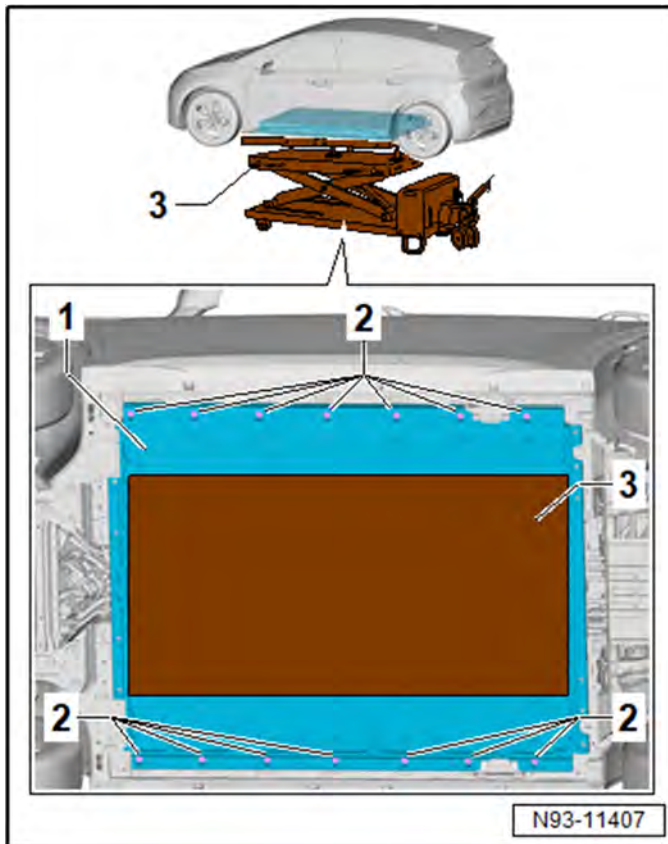

Remove high-voltage battery:

- See ELSA Repair Manual: *Repair Manual > Motor > Electric Drive Rear Wheel Drive EIP220 and All Wheel Drive EIA200, EIP220 > 93 Electric drive > High-Voltage Battery Unit > High-Voltage Battery 1 AX2 , Removing and Installing, 82 kWh*
- Note the following when removing the high-voltage battery:
 - Mark the position of the scissor lift table on the floor to aid in re-positioning the table during reinstallation.
 - Pay close attention to all wiring harnesses when lowering the battery.
 - Pay close attention to coolant hoses when lowering the battery.



Secure media duct/channel (if necessary):

- If the media duct/channel <1> had not yet been secured, install new bolts <circles> and torque to 20 Nm.

Part Number	Part Description
N -102-252-02	Bolt

NOTE

If the media channel is already secured with bolts, the bolts do not have to be replaced again.



Clean high-voltage battery cover:

- Vacuum all loose dirt and debris from high-voltage battery.
- It is also recommended to clean the connection element threads using a wire brush as shown.

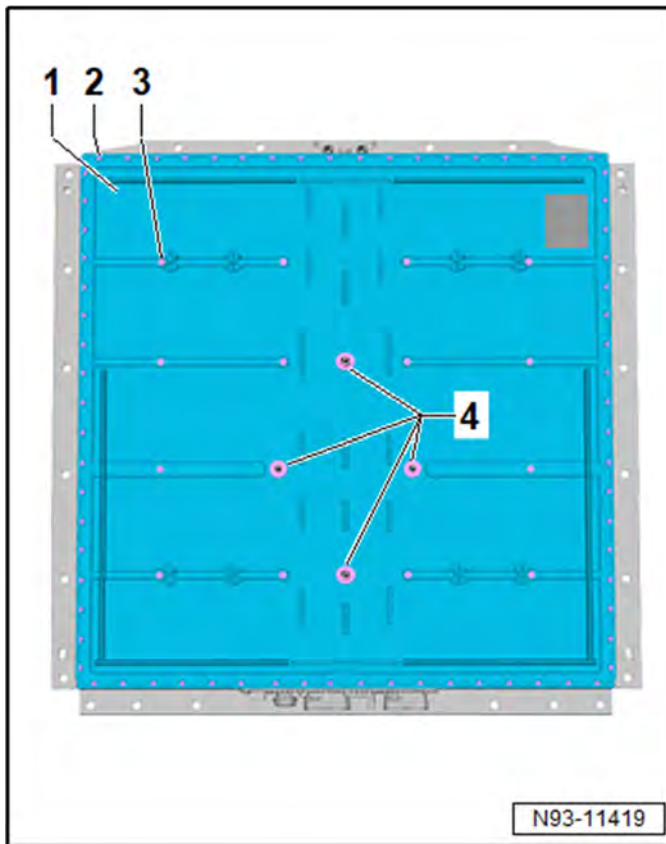

Remove high-voltage battery cover:

- See ELSA Repair Manual: *Repair Manual > Motor > Electric Drive Rear Wheel Drive EIP220 and All Wheel Drive EIA200, EIP220 > 93 Electric drive > High-Voltage Battery Unit > High-Voltage Battery 1 AX2 , Opening*

⚠ DANGER

**High voltage increases the risk of fatal injury
Electrocution can cause severe bodily or fatal injury**

Pay close attention to which Repair Manual steps require Personal Protective Equipment.

ⓘ NOTE

The upper part of battery housing can be reused under certain circumstances and does not have to be replaced.

To determine if the cover can be reused, refer to the ELSA Repair Manual: *Repair Manual > Motor > Electric Drive Rear Wheel Drive EIP220 and All Wheel Drive EIA200, EIP220 > 93 Electric drive > High-Voltage Battery Unit > Battery Housing Upper Section, Checking for Re-Use*

Identify cell module which requires replacement:

- Use the chart found in one of the 93O2 attachment tabs in ELSA or in ServiceNet to determine the serial number of the module that requires replacement for the VIN you're working on.
- Identify the module that requires replacement and clearly mark its location.



NOTE

If the serial number cannot be found on any of the cell modules, it is possible the module was replaced on a previous service visit.

If the serial number cannot be found on any of the cell modules, create a VTA [WEB](#) ticket and wait for further instructions. Include photos of the serial numbers for each of the 12 cell modules and the high-voltage battery identification/part number label.

Example of high-voltage battery identification, located on one end of the high-voltage battery case:

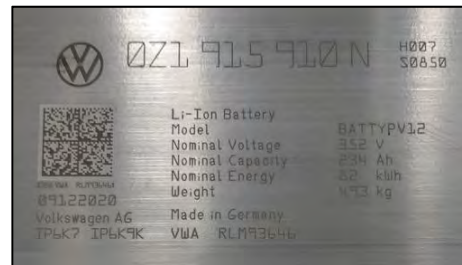

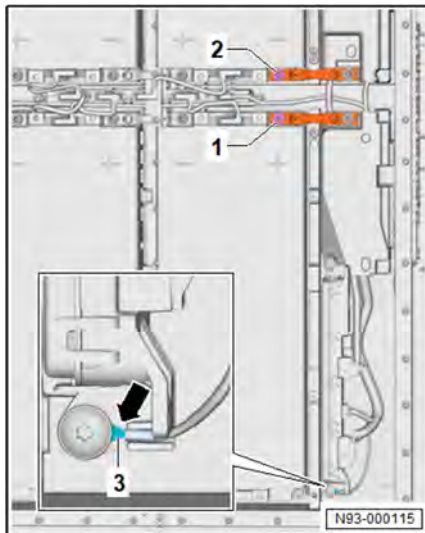

Perform insulation measurement:

- Perform insulation measurement according to ELSA Repair Manual: *Repair Manual > Motor > Electric Drive Rear Wheel Drive EIP220 and All Wheel Drive EIA200, EIP220 > 93 Electric drive > High-Voltage Battery Unit > Voltage and Insulation Measurement, 82 kWh*
- Perform the measurement in conjunction with ODIS test plan, "HV measurement module VAS6558/VAS6558A."

Tests in current test plan	
Status	Tests (sorted according to chances of success)
	008C - High-voltage cooling system leak test
	008C - Controller configuration
	008C - High-voltage battery leak test
	High-voltage system, de-energize
	HV measurement module VAS6558/VAS6558A
	008C - Measuring values
	008C - Identification
	008C - Event memory



Clean high-voltage battery sealant off of lower housing:

- Clean old sealant using a lint free cloth and Cleaner D -009-401-04 or isopropyl alcohol.

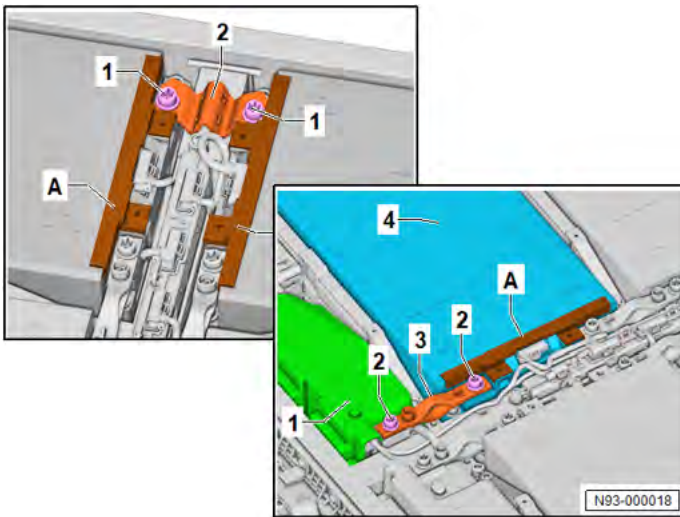

Disconnect the high-voltage circuit:

- See ELSA Repair Manual: *Repair Manual > Motor > Electric Drive Rear Wheel Drive EIP220 and All Wheel Drive EIA200, EIP220 > 93 Electric drive > High-Voltage Battery Unit > Circuit, Disconnecting, 82 kWh*

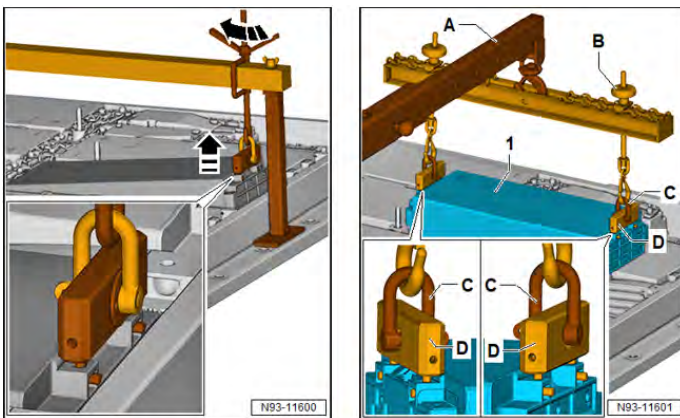

Remove the cell module:

- See ELSA Repair manual: *Repair Manual > Motor > Electric Drive Rear Wheel Drive EIP220 and All Wheel Drive EIA200, EIP220 > 93 Electric drive > High-Voltage Battery Components > Battery Module, Removing*
- Ensure the shock protection is installed on ALL open high-voltage connections.

TIP

Pay close attention to the wiring harnesses, so they are not damaged or pinched during removal.

The cell module can be freed from the adhesive bond from either end of the cell module.



Clean the mounting area for the new cell module:

- When cleaning the cell module mounting area, use extreme care so the sealant for the high-voltage battery splines and lower housing is not damaged and that no cleaners come into contact with the sealant.
- Vacuum any loose debris from the mounting area of the cell module.
- Clean cell module mounting area with Cleaner D -009-401-04 or isopropyl alcohol and allow it to completely dry.
- Do not allow the cleaner to come in contact with any of the lower housing frame sealant.

Installing new cell module(s):

- Reference ELSA Repair manual: *Repair Manual > Motor > Electric Drive Rear Wheel Drive EIP220 and All Wheel Drive EIA200, EIP220 > 93 Electric drive > High-Voltage Battery Components > Battery Module, installing*
- Note the following when installing the new cell module(s):
- Peel off the protective backing and apply the separating foil <arrow> as needed along the outer frame edges, in the area where the cell module is mounted.



Part Number	Part Description
0Z1-998-474	Separating foil/film

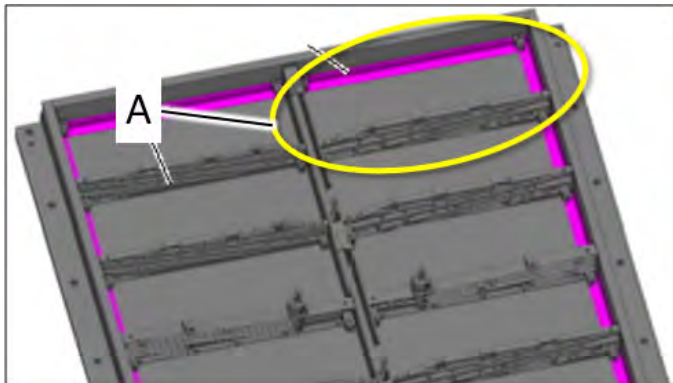

- If the cell module being replaced is in the corner of the high-voltage battery, the separating foil must be applied to both outer frame edges as shown in area <A>.

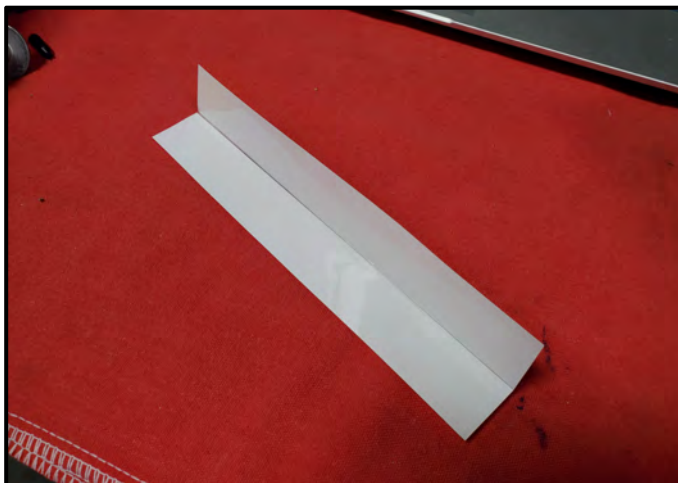

TIP

Having a second technician pre-fold the separating film before installing will aid in applying the film.



- Clean the bottom of the cell module using Cleaner D -009-401-04 or isopropyl alcohol and allow it to dry completely.



- Double check the expiration date of the paste before applying.
- Use Double Cartridge Adhesive Gun -VAS5237- to apply the heat paste.

Part Number	Part Description
D -G00-018-M2	Heat paste

- Before applying the heat paste, release a small amount through the applicator to ensure the paste is mixing properly.



- When filling Template -T10606-, ALL of the heat paste must be used.

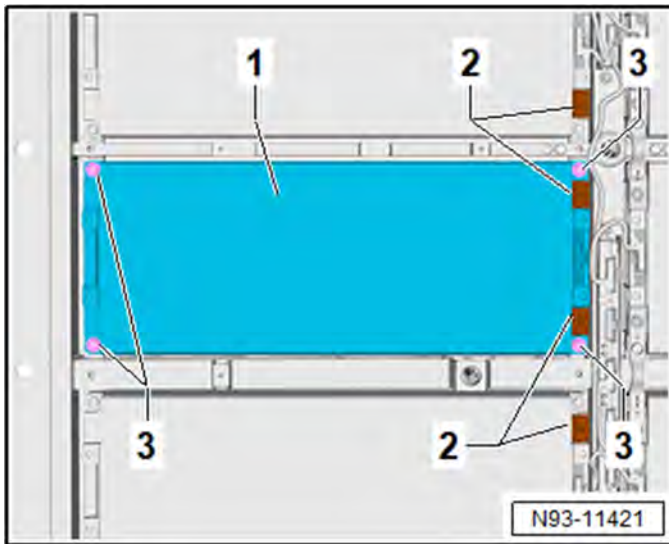

- Pay close attention to the wiring harnesses when installing the cell module.
- Torque new bolts <3> in a cross pattern to 16 Nm + 180°.

Part Number	Part Description
N -912-809-01	Bolt

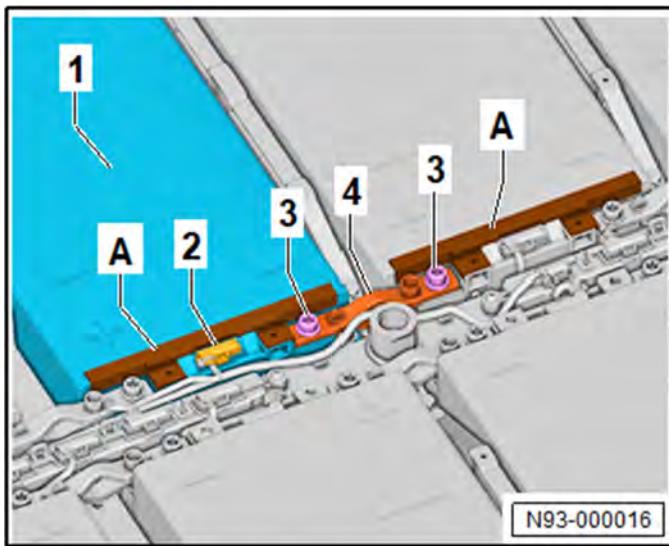

- Torque bolts <3> for the high-voltage connection <4> to 8 Nm.



⚠ DANGER

STOP! STOP!

Incorrect installation of battery modules and module connectors.

Short circuit electric arc can cause severe bodily or fatal injuries.

Check the battery modules and module connectors for correct installation.

Only continue with the procedure when there is no voltage in between the battery terminals.

Pay very close attention to the Repair Manual steps outlining the use of the -VAS6762/45-.

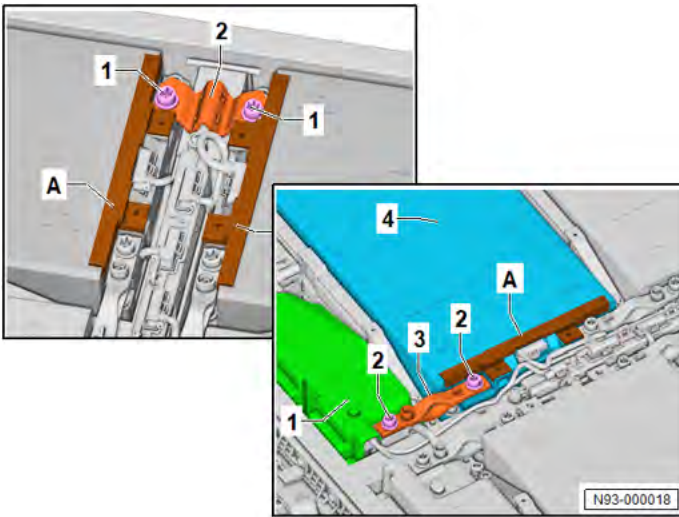

Reconnect high-voltage circuit:

- Reconnection is the reverse order of disconnecting.
- Reference ELSA Repair Manual: *Repair Manual > Motor > Electric Drive Rear Wheel Drive EIP220 and All Wheel Drive EIA200, EIP220 > 93 Electric drive > High-Voltage Battery Unit > Circuit, Disconnecting, 82 kWh*



Check for high-voltage battery faults:

- Using -VAS671007- or -VAS5581A-, in conjunction with the Diagnostic Tester, verify there are no faults stored for any high-voltage battery component before installing the high-voltage battery cover.

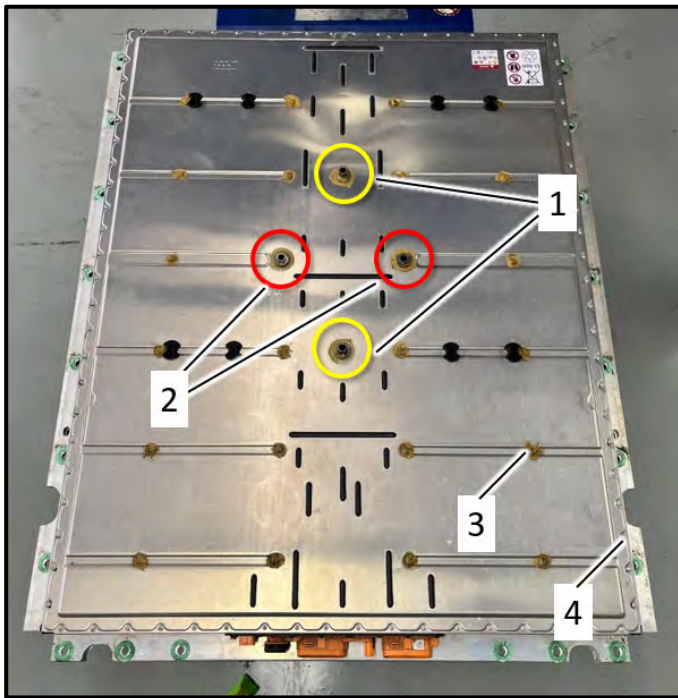

Install and seal high-voltage battery cover:

NOTE

The upper part of battery housing can be reused under certain circumstances and does not have to be replaced.

To determine if the cover can be reused, refer to the ELSA Repair Manual: *Repair Manual > Motor > Electric Drive Rear Wheel Drive EIP220 and All Wheel Drive EIA200, EIP220 > 93 Electric drive > High-Voltage Battery Unit > Battery Housing Upper Section, Checking for Re-Use*

TIP

Ensure all shock protection is removed prior to installing cover.

Pay attention to the cover position. The cover part number stamping is positioned at the front of the high-voltage battery.

- SEE ELSA Repair Manual: *Repair Manual > Motor > Electric Drive Rear Wheel Drive EIP220 and All Wheel Drive EIA200, EIP220 > 93 Electric drive > High-Voltage Battery Unit > High-Voltage Battery 1 AX2 , Sealing, 82 kWh*

Part Number	Part Description
1EA-804-841-AC	Cover (if necessary)
D -454-300-H2	Sealant
1EA-802-131-A	Connection element (qty. 2) Position <1>
1EA-802-132-A	Connection element (qty. 2) Position <2>
WHT-008-738-A	Middle bolts (qty. 22) Position <3>
WHT-009-218	Perimeter bolts (qty. 82) Position <4>

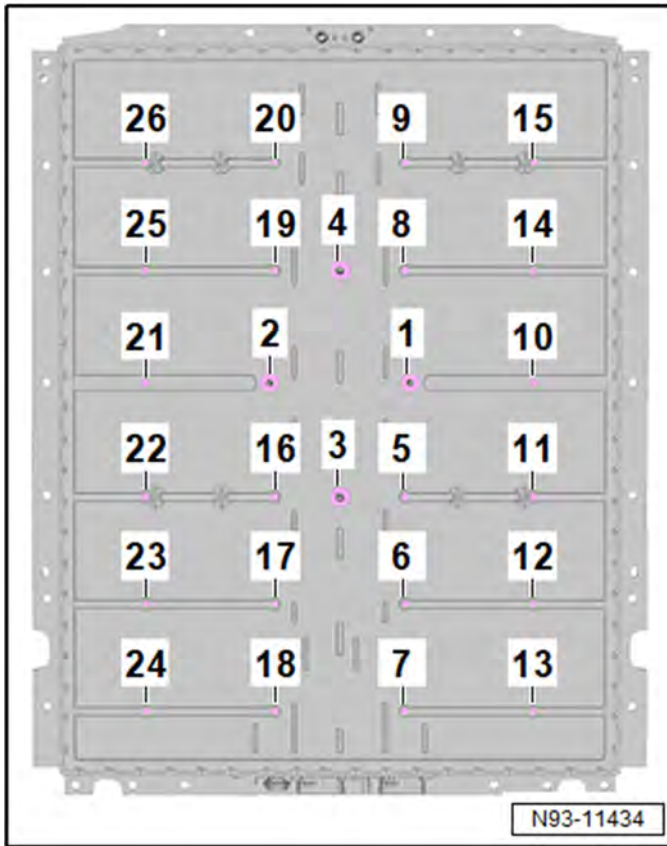

- Torque the new fasteners in the following order:
 1. Connection element bolts <1 through 4> to 100 Nm.
 2. Middle bolts <5 through 26> to 5.5 Nm + 90°.

TIP
Utilize a second technician to keep track of or mark each bolt once it has been torqued.

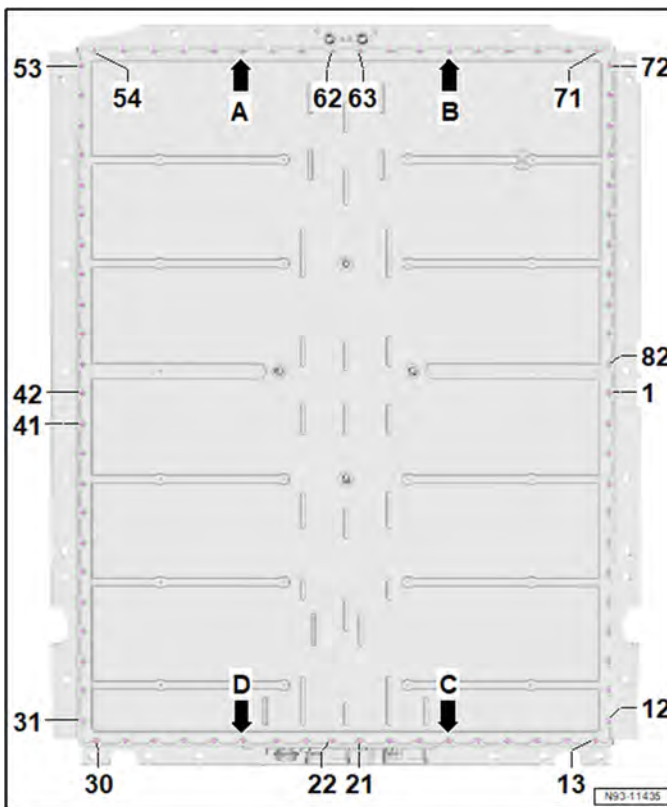

3. Bolts <A, B, C and D> to 8 Nm.
4. Bolts <1 through 82> to 8 Nm.

Tests in current test plan	
Status	Tests (sorted according to chances of success)
	008C - High-voltage cooling system leak test
	008C - Controller configuration
	008C - High-voltage battery leak test
	High-voltage system, de-energize
	HV measurement module VAS6558/VAS6558A
	008C - Measuring values
	008C - Identification
	008C - Event memory

Perform high-voltage battery leak test:

- See ELSA Repair Manual: *Repair Manual > Motor > Electric Drive Rear Wheel Drive EIP220 and All Wheel Drive EIA200, EIP220 > 93 Electric drive > High-Voltage Battery Unit > High-Voltage Battery 1 AX2 Leak Test*
- Perform these steps in conjunction with Guided Function test plan, "008C – High-voltage battery leak test."

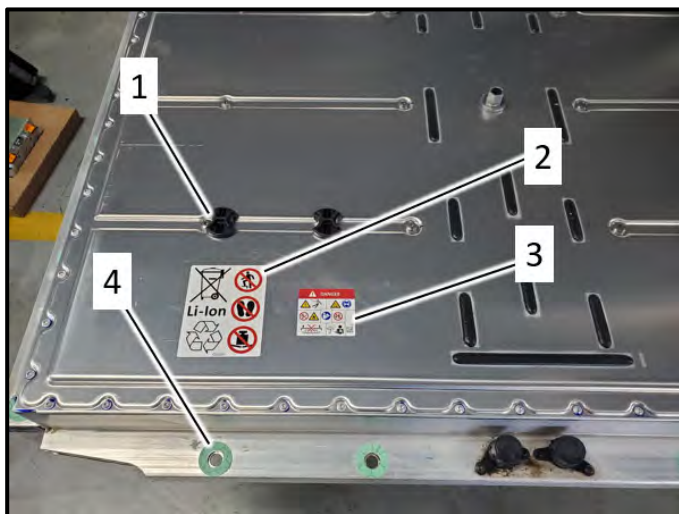

Prepare high-voltage battery for installation:

NOTE

Replacing the spacers and stickers is only necessary if the high-voltage battery cover is replaced.

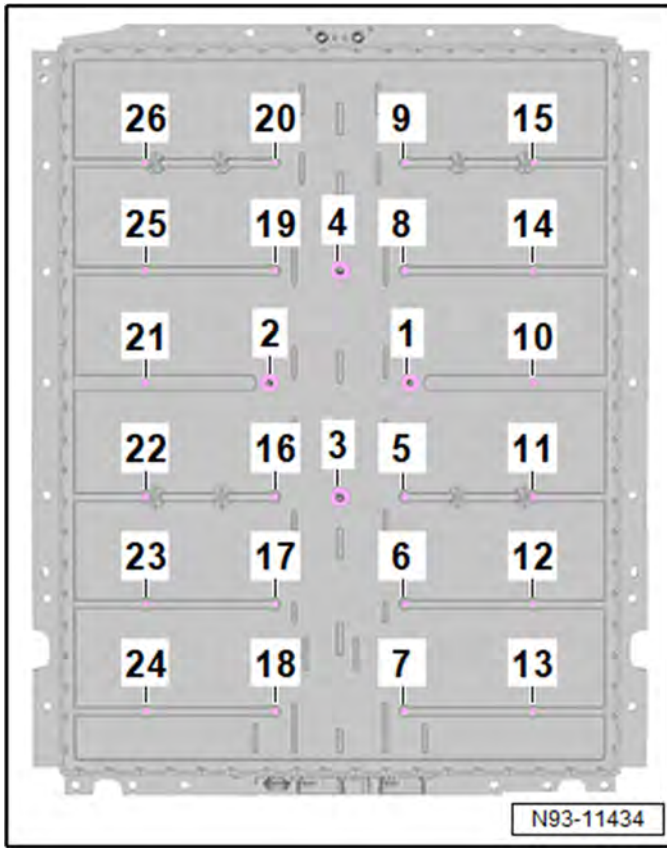

- Install new spacers <1> (qty. 8) onto the high-voltage battery cover. Reference the old cover for installation position if needed.
- Apply new sticker <2> and warning sign <3>.
- Remove old separating film <4> from around the high-voltage battery mounting holes and install new separating film.
 - Do not install separating film if there was no existing film already in place.

Part Number	Part Description
1EA-804-973	Spacer (qty. 8)
1EA-998-103	Separating film
12E-010-006-AA	Sticker
1EA-010-505	Warning sign

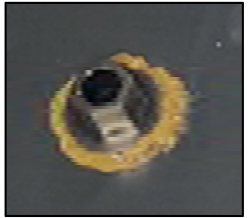

- Apply wax around the base of the connection elements <1 through 4>.
- Completely cover all (22) middle bolts <5 through 26> with wax.

Part Number	Part Description
D -316-000-A1	Wax/Undercoat

 COVERAGE DETAIL	
Connection elements <1 through 4>	
Middle bolts <5 through 26>	

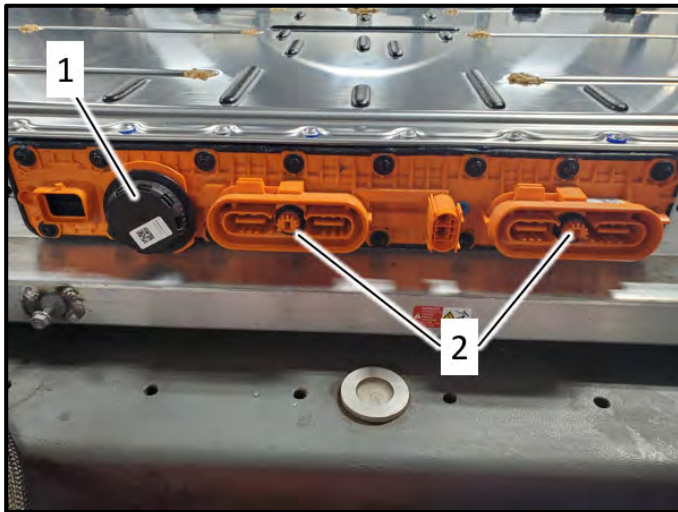

- Install new pressure relief valve <1> and connection seals <2>.

Part Number	Part Description
1HV-915-754-A	Valve
0Z1-915-433-A	Seal (qty. 2)

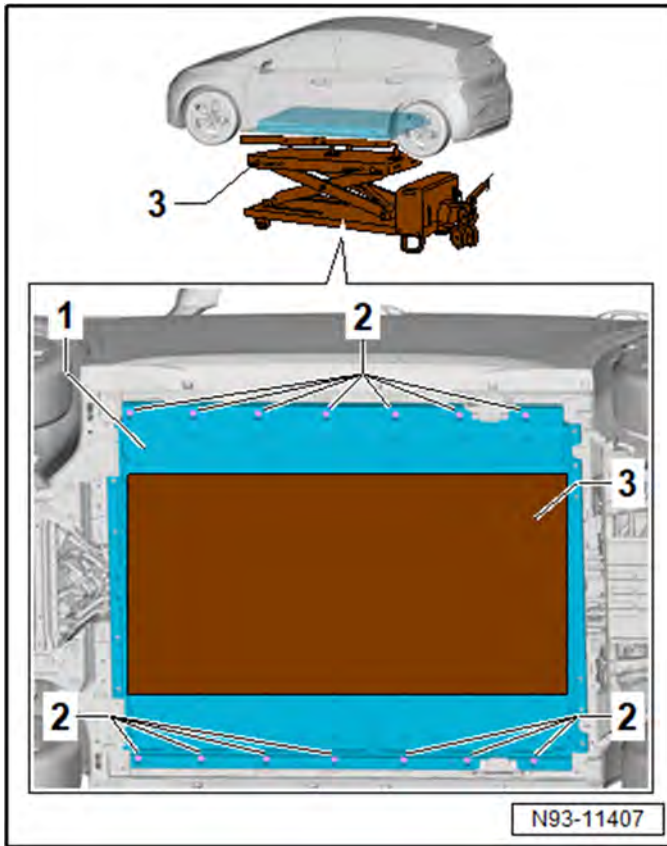

Re-install high-voltage battery:

- Installation is the reverse order of removal.
- See ELSA Repair Manual: *Repair Manual > Motor > Electric Drive Rear Wheel Drive EIP220 and All Wheel Drive EIA200, EIP220 > 93 Electric drive > High-Voltage Battery Unit > High-Voltage Battery 1 AX2 , Removing and Installing, 82 kWh*
- Use new bolts.

Part Number	Part Description
N -912-832-01	Center bolts (qty. 4)
N -909-428-04	Perimeter bolts (qty. 24)

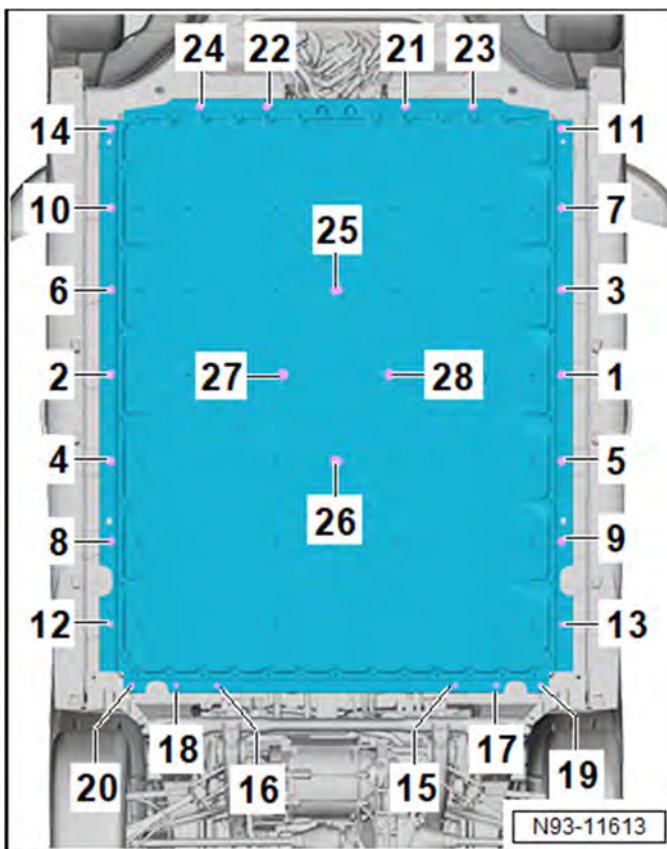

- Torque the new bolts in the following sequence:
 1. Bolts <1 through 24> to 50 Nm + 90°.
 2. Bolts <25 through 28> to 40 Nm + 180°.

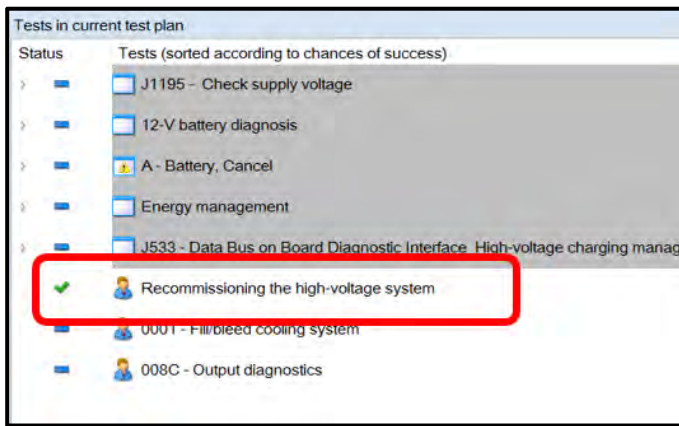

Recommission the high-voltage system:



**High voltage increases the risk of fatal injury
Electrocution can cause severe bodily or fatal injury**

Have a high-voltage technician or a high-voltage expert recommission the high-voltage system.

- Follow the Guided Functions test plan steps.
- Pay close attention to all of the test plan steps.

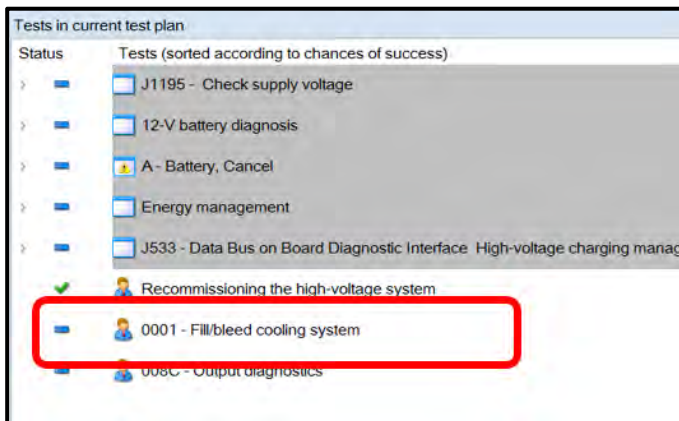

Fill cooling system:

- Top off coolant.
- Select “Self Test” and populate test plan, “0001 – Fill/bleed cooling system.”



- Connect the Cooling System Tester -VAG1274B- and create a pressure of 1.0 bar using the hand pump.
- Run the test plan “0001 – Fill/bleed cooling system” and follow the on-screen prompts.
- Once the test is successfully completed, repeat the test plan a second time.
- Top off coolant.

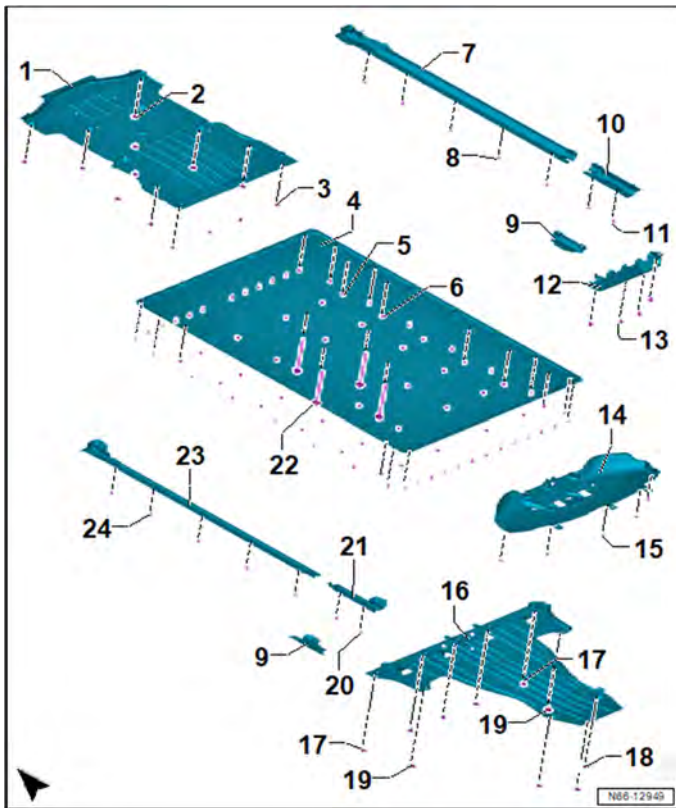

Reinstall underbody covers and side covers:

- Installation is the reverse order of removal.
- Reference the ELSA Repair Manual as needed.
- Replace any damaged fasteners.

Vehicles that had module(s) replaced **ONLY** because they were on the affected serial number list:

- The balancing time counters do not have to be reset.
- Proceed to Section D

Vehicles that had additional module(s) replaced due to increased self-discharge:

- The balancing time counters must be reset via SVM and additional test plans.
- Proceed to Section C

Section C – Reset Balancing Time Counters via SVM

CRITICAL REPAIR STEP



This additional SVM and additional test plan steps are only required if a cell module was replaced according to the direction from the “Check cell equalization” test plan.

If the cell module(s) were replaced only because they were identified by the serial number list, this additional step does not have to be completed.

NOTE

Prior to launching the VAS Diagnostic Tester and starting an update, ensure the following conditions are met;

- ✓ **The ODIS software is completely up to date.**
 - Refer to the “Alerts” section on ServiceNet home page for the current ODIS version.
- ✓ **The battery charger is connected to the vehicle battery and remains connected for the duration of the software update.**
 - Battery voltage must remain above 12.5 volts for the duration of the software update. Failure to do so may cause the update to fail, which could result in damage to the control module. Control modules damaged by insufficient voltage will not be covered.
- ✓ **The screen saver and power saving settings are off.**
 - Failure to do so may result in the tester entering power save mode during the software update, which could result in damage to the control module.
- ✓ **The VAS Diagnostic Tester is plugged in using the supplied power adapters.**
 - Under no circumstances should the tester be used on battery power alone during the software update. Failure to do so may result in the tester powering off during the update, which could result in damage to the control module.
- ✓ **The VAS Diagnostics Interface **MUST ONLY** be connected to the tester with a USB cable.**
 - Performing a software update using a Bluetooth or WiFi connection increases the risk of losing connection during the update, which could result in damage to the control module. It also greatly increases the time required to perform the update. Requests for additional time or parts will be denied if the GFF log shows the update was performed using Bluetooth or WiFi.

WARNING

Radiator Fan(s) may cycle ON high speed during the Update Process! There is a serious risk that personal injury may result if contact is made with spinning fan blades. Keep hands and all objects away from Radiator Fan(s) during Update Process!

TIP

To Update-Programming using SVM, review and follow instructions in Technical Bulletin 2014603: *Software Version Management (SVM) Operating Instructions*.

The SVM Process must be completed in its entirety so the database receives the update confirmation response. A warranty claim may not be reimbursed if there is no confirmation response to support the claim.

NOTE

- Damages resulting from improper repair or failure to follow these work instructions are the dealer's responsibility and are not eligible for reimbursement under this action.
- Diagnosis and repair of pre-existing conditions in the vehicle are not covered under this action.

NOTE

- All campaign software updates should be completed during a single, standalone ODIS Diagnostic Session. You must fully complete this campaign and send all logs before beginning any other campaigns or operations.
- If there are any ODIS "Hot-Fix" patches installed, they must be removed from the scan tool before beginning this operation. ODIS "Hot-Fix" patches may affect the update process.



CRITICAL REPAIR STEP

STOP! STOP!

Before starting programming, it is essential to perform the following actions for the -VAS5908-battery charger.

The battery charger's default setting will switch the charger off automatically after a period of time. To prevent this, the following must be carried out.

Switch it OFF and then ON again each time the charger is connected.

The battery charger's display must have switched off before it's restarted.

- Connect battery charger -VAS5908-.
- When connecting the charger to the battery, connect the positive cable to the positive charging terminal for the battery and connect the negative cable to the grounding lug on the chassis. **DO NOT** connect the ground cable directly to negative terminal of the battery.



- Place the vehicle key over the reader coil in the center console cupholder.
- Any additional keys must be a minimum of 20 meters away from the vehicle.



- Confirm that scan tool is communicating with the diagnostic head by USB <Green Arrow>.
 - If the Bluetooth symbol is shown <Red Arrow> then disconnect the diagnostic head from the vehicle and reconnect the USB cable to the diagnostic head and then reattach to the vehicle.
- Upon ODIS startup, verify the “Diagnosis” operating mode is selected <as shown>.

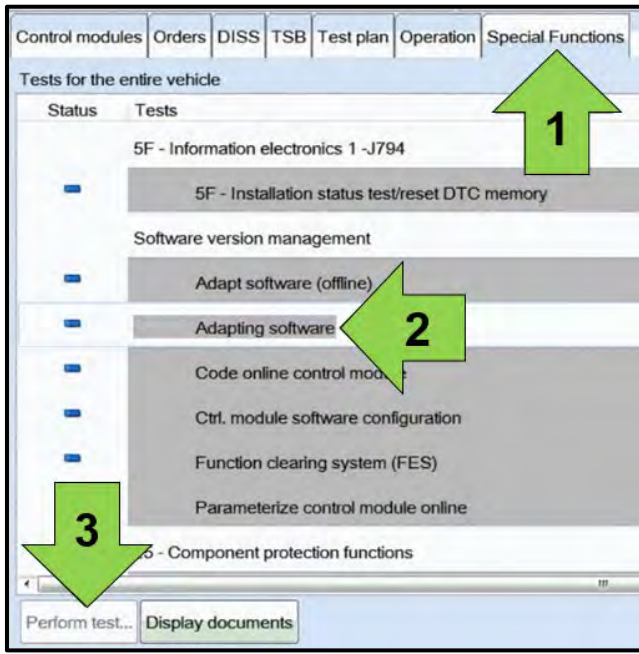

- Once the GFF scan is complete, select “Special functions” <arrow 1>, then “Adapting software” <arrow 2>, then select “Perform test” <arrow 3>.

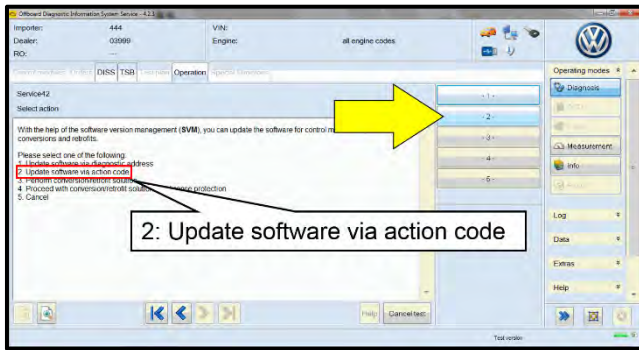

- Select the correct option to “Update software via action code”.

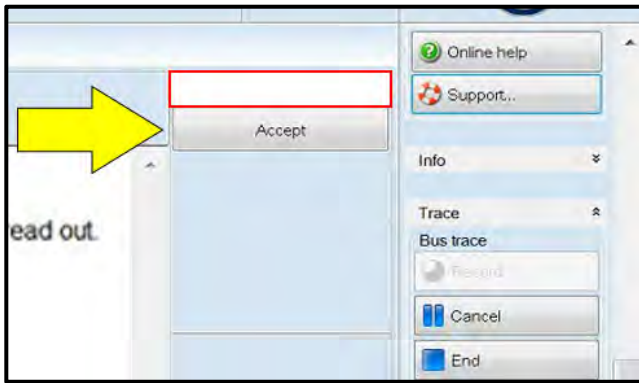

NOTE

Using Bluetooth or WiFi for this action is PROHIBITED!

Damage caused to electronic components during the SVM flash process is not covered.

- Enter the corrective action code (SVM code) as listed below based on the current software version of diagnostic address 008C.

TIP

The GFF test plan for checking cell equalization should also direct which SVM code to use.

008C Software Version	SVM code
1030	8CHVHDM1030
0930	8CHVHDM0930

- Select “Accept” <arrow> and follow the on screen prompts.

NOTE

Do not unplug the sound generator.

- Do not end the diagnosis session.

Perform bus sleep:

- Carry out the following steps in the specified sequence to put the vehicle in a bus sleep.
- Switch off the ignition.
- Turn the hazards off.
- Remove diagnosis interface from the vehicle diagnosis connection.
- Remove battery charger from the 12V battery.
- Close front and rear lid as well as all doors.
- Lock vehicle.
- Move vehicle key (remote control) at least 20 meters away from the vehicle.
- Wait at least 15 minutes until the vehicle is in bus silence.
- Then unlock vehicle again.

The repair information in this document is intended for use only by skilled technicians who have the proper tools, equipment and training to correctly and safely maintain your vehicle. These procedures are not intended to be attempted by “do-it-yourselfers,” and you should not assume this document applies to your vehicle, or that your vehicle has the condition described. To determine whether this information applies, contact an authorized Volkswagen dealer. ©2022 Volkswagen Group of America, Inc. and Volkswagen Canada. All Rights Reserved.

- Connect and switch on battery charger.
- Insert diagnosis interface on vehicle diagnosis connection.
- Switch on the ignition.
- Place a vehicle key (remote control) in the center console on the reader coil.

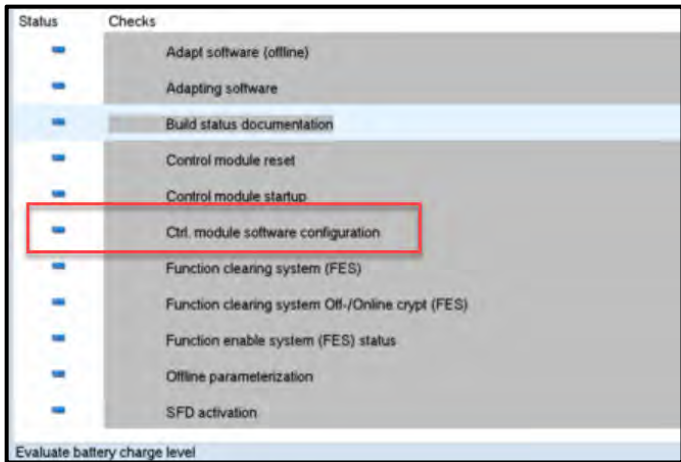

Perform software configuration:

- From the special function tab, select “Ctrl. module software configuration”.
- When prompted, select the option to perform the “SWK via diagnostic address”.
- Enter diagnostic address 008C.
- Follow the on-screen prompts.
- Pay close attention to all steps outlined in the test plan and follow them exactly as described.
- Do not end the diagnostic session.

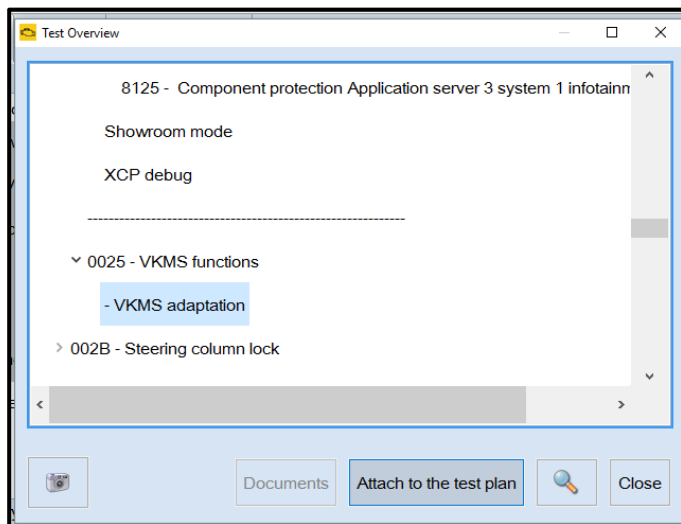

Perform “VKMS Adaptation” test plan:

- Turn ignition OFF.
- Turn ignition ON and briefly make vehicle Drive ready.
- Turn ignition OFF and back ON.
- Start the VKMS Adaptation test plan.
- Follow the on-screen prompts.
- Pay close attention to all steps outlined in the test plan and follow them exactly as described.
- Once all test plans are complete, exit Diagnosis and send the diagnostic protocol online.

Proceed to Section D

Section D – Campaign Completion Label

Install Campaign Completion Label

- Fill out and affix Campaign Completion Label, part number CAMP 010 000, next to the vehicle emission control information label.



TIP

Ensure Campaign Completion Label does not cover any existing label(s).

Proceed to Section E

Section E - Parts Return/Disposal

High-Voltage Cell Modules:

US Dealers:

Refer to the HV Battery Recycling Program information found in ServiceNet: *ServiceNet > Electric/PHEV Vehicles*

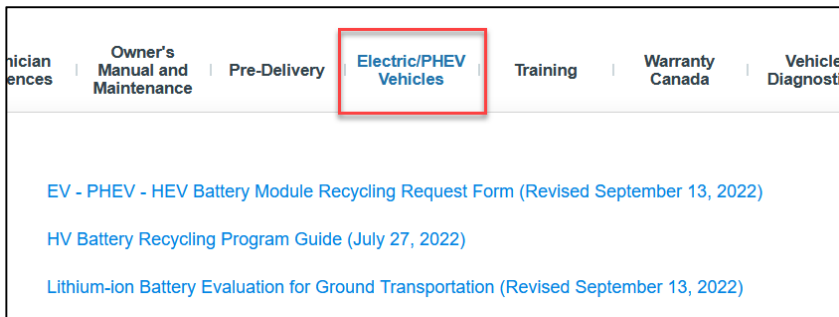

Canadian Dealers:

Refer to the latest version of TSB 2060231

All other parts:

Properly store (retain), destroy or dispose of removed parts in accordance with all state/province and local requirements, unless otherwise indicated and/or requested through the Warranty Parts Portal (WPP) for U.S. and the Part Destruction and Core Disposition Report for Canada.