

**ATTENTION:**  
 GENERAL MANAGER   
 PARTS MANAGER   
 CLAIMS PERSONNEL   
 SERVICE MANAGER

IMPORTANT - All Service Personnel Should Read and Initial in the boxes provided, right.

© 2022 Subaru of America, Inc. All rights reserved.



QUALITY DRIVEN® SERVICE

**PRODUCT CAMPAIGN BULLETIN**

**APPLICABILITY:** 2019-2022MY Ascent

**NUMBER:** WRL-22R

**SUBJECT:** PTC Heater Ground Bolt

**DATE:** 12/12/22

**NHTSA:** 22V-907

**REVISED:** 01/09/23

Subaru of America, Inc. (Subaru) is initiating a new safety recall for certain 2019-2022 model year Ascent vehicles.

**DESCRIPTION OF THE DEFECT AND SAFETY RISK**

The ground bolt that secures the ground terminal of the Positive Temperature Coefficient (PTC) heater may have been improperly fastened during vehicle production. This potential condition may result in the melting of the ground terminal and surrounding components when the PTC heater is in operation, increasing the risk of a fire.

**REMEDY**

For all potentially affected vehicles, Subaru retailers will replace the PTC heater ground bolts and, if necessary, replace the ground wire harness and connector holder at no cost to the customer.

- As a precautionary measure, it is highly recommended that owners park their vehicle away from any garage, car port or other structure until this repair is completed.
- Additionally, owners should never leave the vehicle unattended while the engine is running until this repair is completed.
- If an owner notices or smells melting plastic or smoke coming from the dash or driver’s footwell area, the ignition should be placed in the “off” position and the vehicle should not be operated. If this occurs, the owner should immediately contact Subaru’s Roadside Assistance or the nearest Subaru retailer for assistance.

**CAUTION: VEHICLE SERVICING PERFORMED BY UNTRAINED PERSONS COULD RESULT IN SERIOUS INJURY TO THOSE PERSONS OR TO OTHERS.**

Subaru Service Bulletins are intended for use by professional technicians ONLY. They are written to inform those technicians of conditions that may occur in some vehicles, or to provide information that could assist in the proper servicing of the vehicle. Properly trained technicians have the equipment, tools, safety instructions, and know-how to do the job correctly and safely. If a condition is described, DO NOT assume that this Service Bulletin applies to your vehicle, or that your vehicle will have that condition.

Subaru of America, Inc. is ISO 14001 Compliant

ISO 14001 is the international standard for excellence in Environmental Management Systems. Please recycle or dispose of automotive products in a manner that is friendly to our environment and in accordance with all local, state and federal laws and regulations.

*Continued...*

## AFFECTED VEHICLES

A total of 271,694 U.S. vehicles will be included in this recall as listed below. Not all vehicles in the production range listed above are affected by this recall. Coverage must be confirmed by using the Vehicle Coverage Inquiry function on [subarunet.com](http://subarunet.com) prior to repair. This information is now available.

Model Year	Carline	Production Date Range
2019-2022	Ascent	February 23, 2018 – April 28, 2022

The VIN status for this recall will display as ‘Open-Limited Parts Available’ until the owner notification letters are mailed, at which time the status will be updated to ‘Open.’ Repairs can begin prior to the owner notification.

## RETAILER RESPONSIBILITY

***Please be advised that it is a violation of Federal law for a dealer to deliver a new motor vehicle covered by a recall under a sale or lease until the defect is remedied. Therefore, any Authorized Subaru Retailer failing to perform the applicable service procedures to correct all affected vehicles in their inventory prior to the vehicle being placed in service may be subject to civil penalties of up to \$22,423 per violation (i.e., for each vehicle), as provided in 49 CFR §578.6 and will also be in breach of the Subaru Dealer Agreement.***

Any vehicles listed in any recall/campaign that are in retailer stock must be:

- Immediately identified
- Tagged or otherwise marked to prevent their delivery or use prior to repair
- Repaired in accordance with the repair procedures outlined in the Product Campaign Bulletin

Retailers are to promptly perform the applicable service procedures, to correct all affected vehicles in their inventory (used, demo & SSLP). Whenever a vehicle subject to this recall is taken into retailer inventory necessary steps should be taken to ensure the recall correction has been made before selling or releasing the vehicle.

## OWNER NOTIFICATION

Subaru is in the process of obtaining current vehicle registration data and will notify affected vehicle owners by first class mail within 60 days. Retailers will be advised when owner notification is scheduled.

***Continued...***

**PART INFORMATION:**

Up to two kits may be required for this procedure. The bolt kit is required on ALL vehicles. The harness kit is required if the inspection results confirm further **harness** work is required.

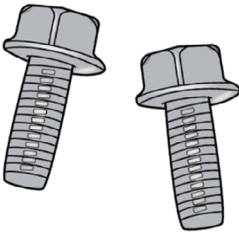

Part Description	Kit Part Number	Qty	Application	Ordering Method
WRL-22 Bolt Kit	SOA635174	1	Required on ALL vehicles	Ordered through PRIME
WRL-22 Harness Kit	SOA635175	1	Required on vehicles needing further <b>harness</b> work after inspection	Currently on HOLD. The PIC team will release the ordered parts when contacted & provided with a valid VIN and QMR number

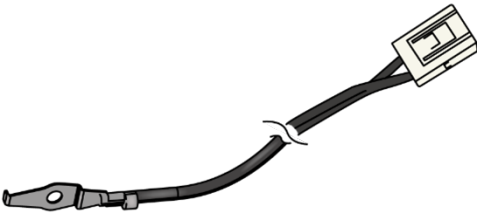
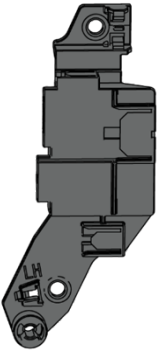
Bolt Kit (SOA635174) Components		
Part Description	Qty	Image
BOLT (Ground Bolt)	2	

Harness Kit (SOA635175) Components		
Part Description	Qty	Image
INST PNL HARN USA (PTC Heater Ground Wire)	1	
CONNECTOR HOLDER LH	1	

*Continued...*

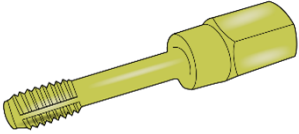
**REQUIRED TOOLS:**

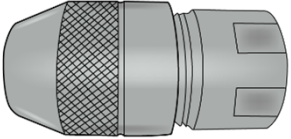
Tool Description	Application	Image
Thread Chaser (M6 x 1.0)	For cleaning the female thread of the ground terminal.	
Tap (M6 x 1.0)	For repairing female thread of the ground terminal.	
Tap Holder	To be used with tap.	

**QMR INFORMATION:**

The following are required when a harness kit (SOA635175) repair is necessary (arcing or melting found at the ground point):

1. There is a QMR submission requirement should a repair require the harness kit (SOA635175).
  - A TechShare QMR must be issued including photo(s) clearly showing the melting or arcing condition found at the ground point necessitating the repair.
  - Include the VOR parts order number for the related harness kit (SOA635175) in the QMR comments. This will be used to prioritize release of parts as they become available.
2. **ALL** claim submissions for repairs requiring a harness kit (SOA635175) will require attachment of photos to the claim submission documenting the condition found requiring a harness kit repair.

*Continued...*

**COMPONENT DESCRIPTION/CONFIGURATION:**

**Diagram 1**

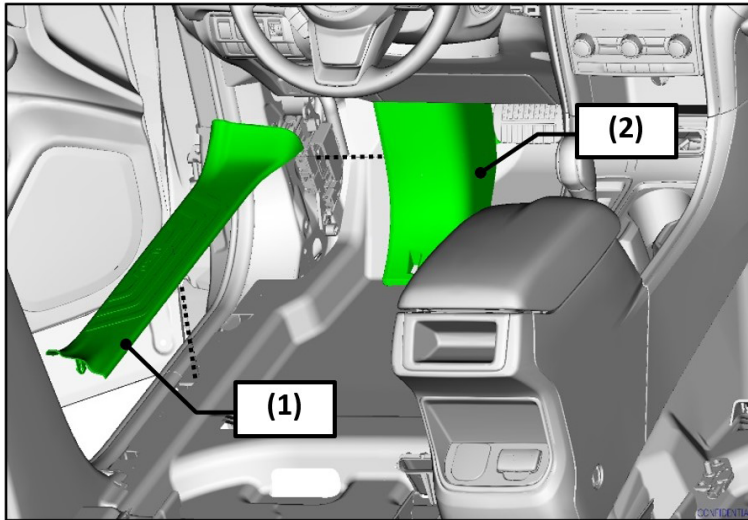

- (1) Left rear side sill cover
- (2) Left front side sill cover
- (3) Ground bolts

**Tightening Torque: 13 N·m**

- (4) Connector holder
- (5) Ground terminal
- (6) Ground wire

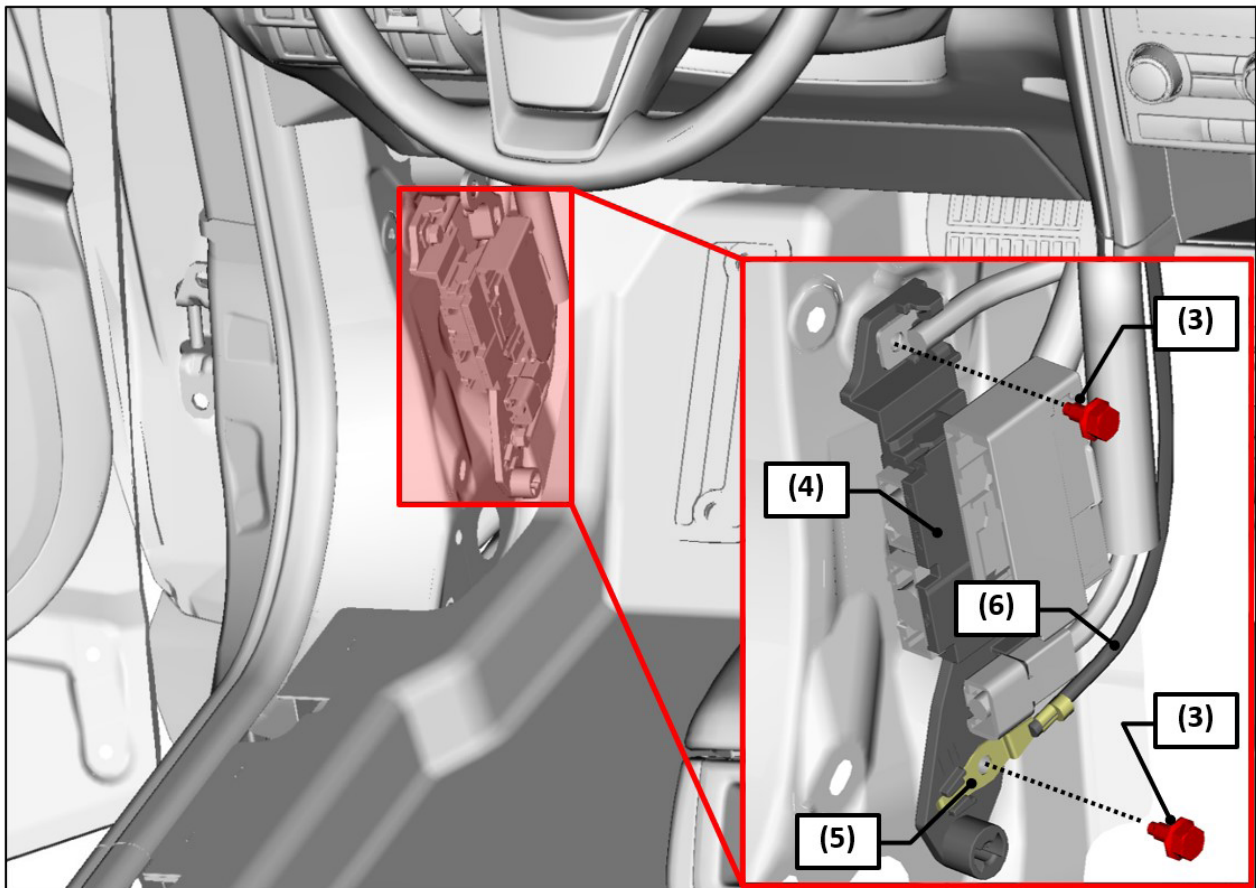

*Continued...*

Diagram 2

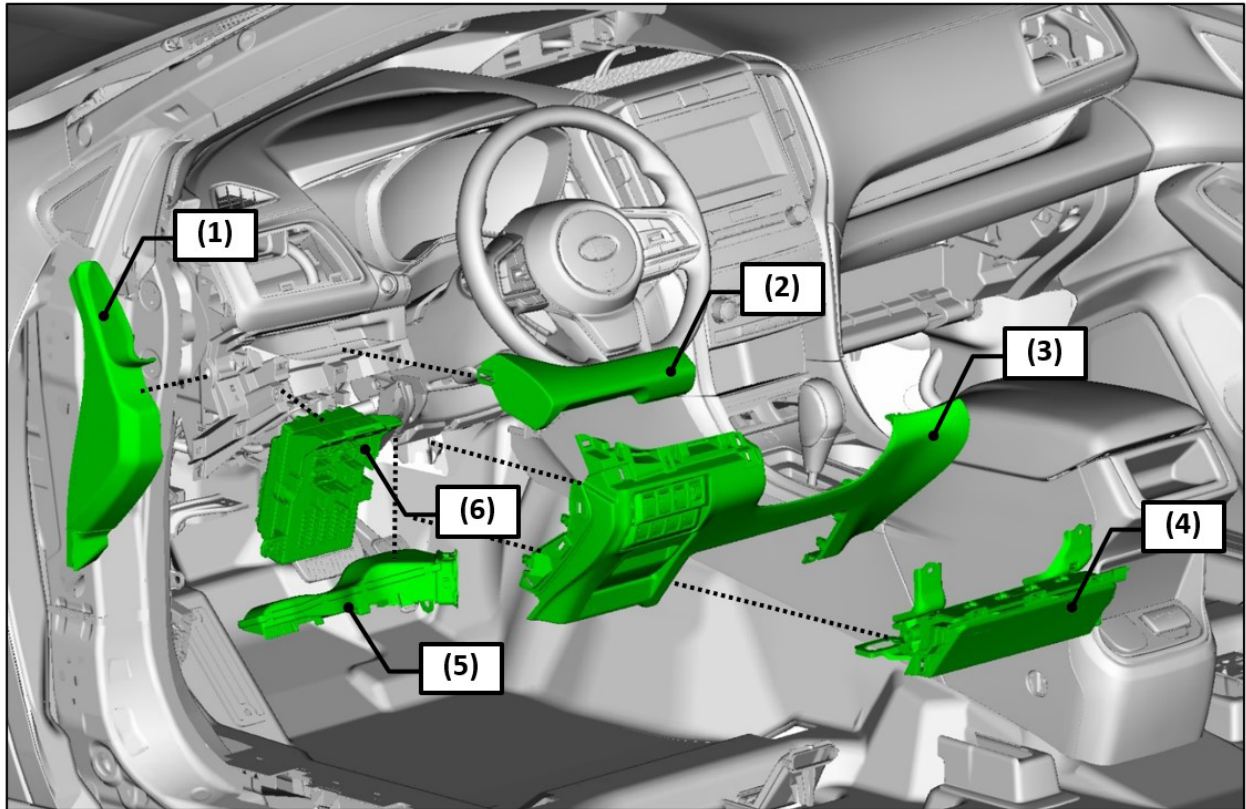

**(1)** Side lid panel

**(2)** Ornament panel

**(3)** Lower cover

**(4)** Knee airbag module

**Tightening Torque : 7.5 N·m**

**(5)** Heater duct

**(6)** Fuse box

**Tightening Torque : 7.5 N·m**

*Continued...*

**Diagram 3**

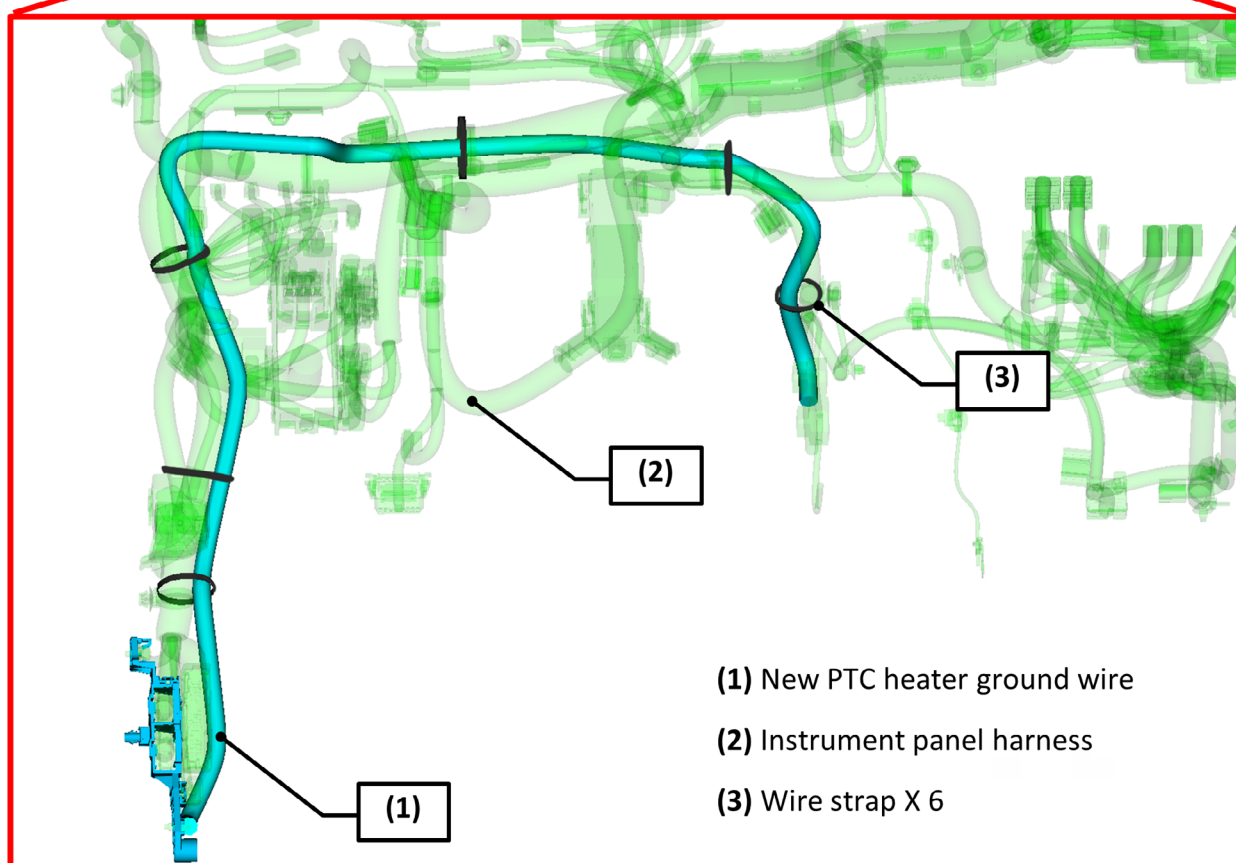
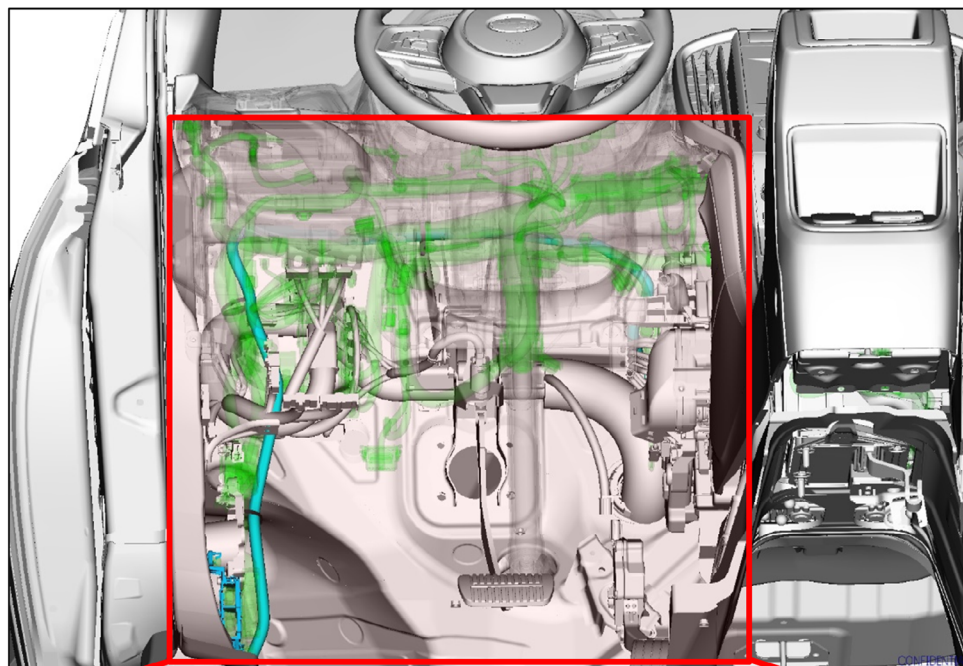

*Continued...*

**Service Procedure / Flowchart:**

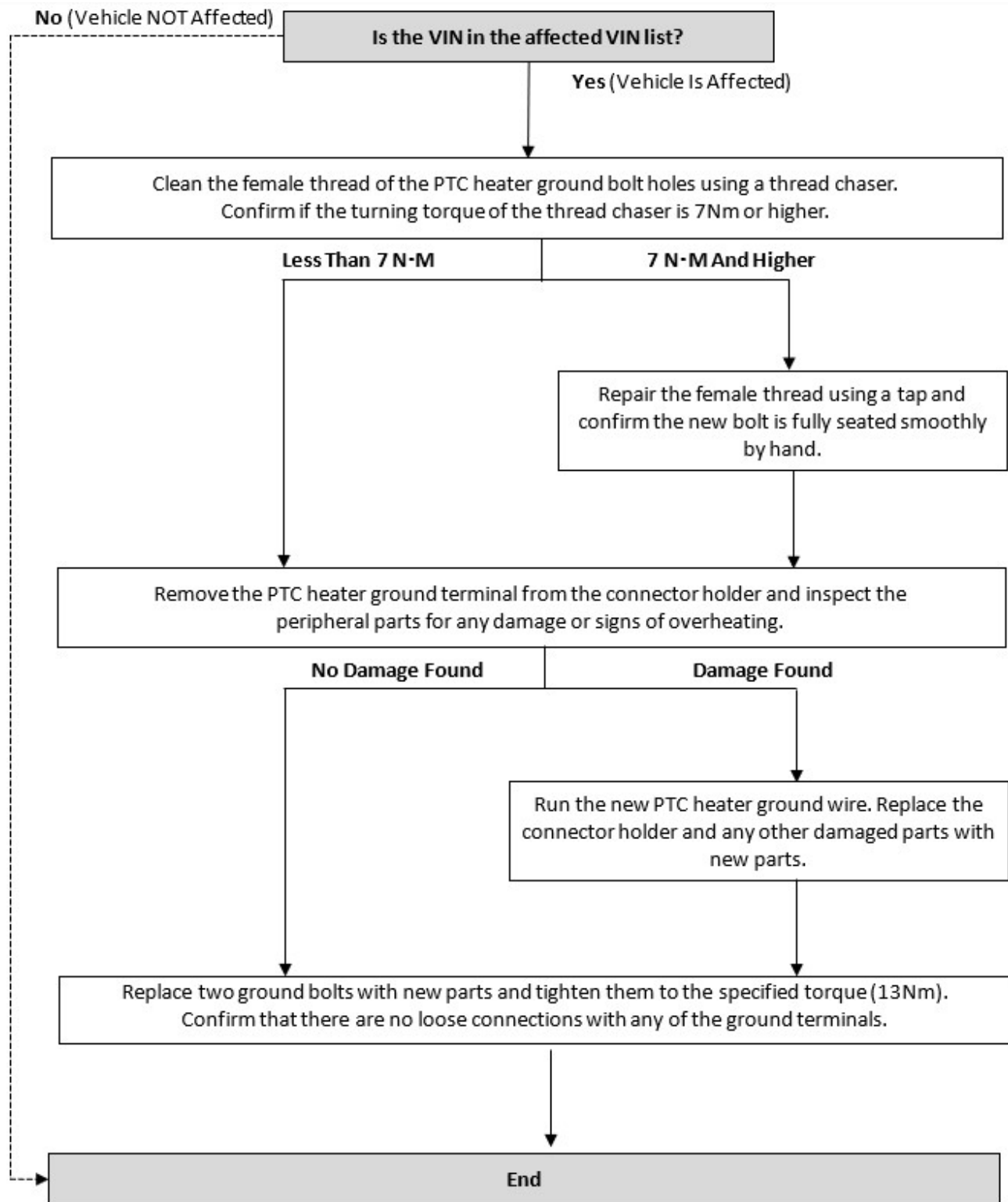

*Continued...*



## SERVICE PROCEDURE / INFORMATION:

**REMINDER:** Customer satisfaction and retention starts with performing quality repairs.

**STEP 1:** Refer to the applicable Service Manual and review: General Description > Repair Contents > Action required before & after Battery Disconnect. Additionally, record any stored seat position(s) before proceeding. Relearn any seat position memory after work is complete. If the power rear gate (PRG) height has been customized, that position must also be noted and relearned.

**STEP 2:** CAREFULLY disconnect the ground terminal from the battery sensor.

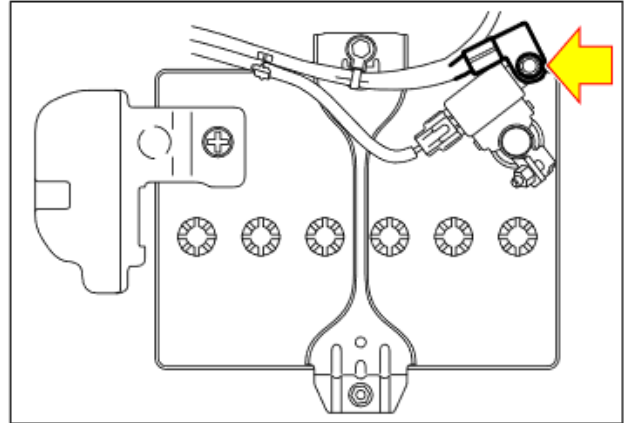

**STEP 3:** Remove the left rear side sill cover on the driver's side of the vehicle.

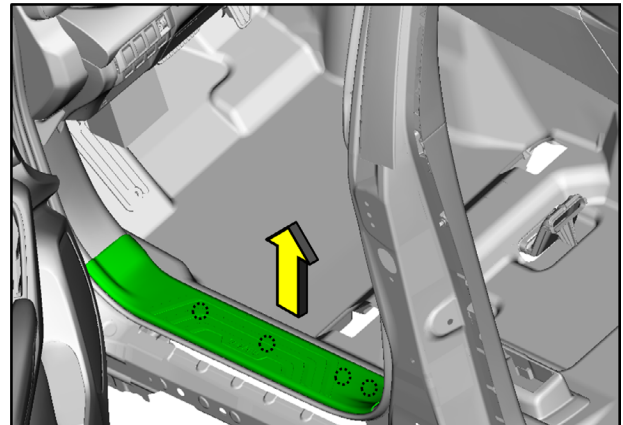

**STEP 4:** Remove the left front side sill cover from the driver's side of the vehicle.

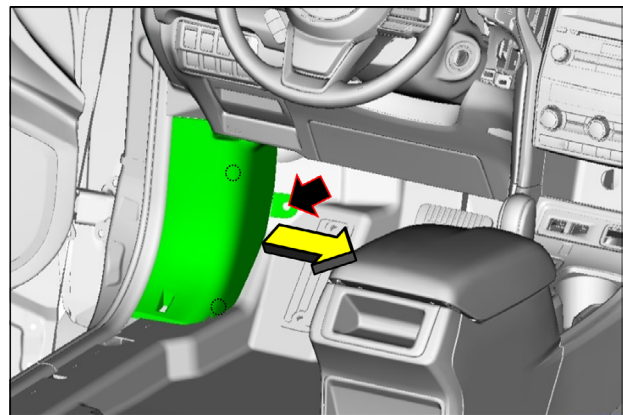

*Continued...*

**STEP 5:** Disconnect all electrical connections from the connector holder.

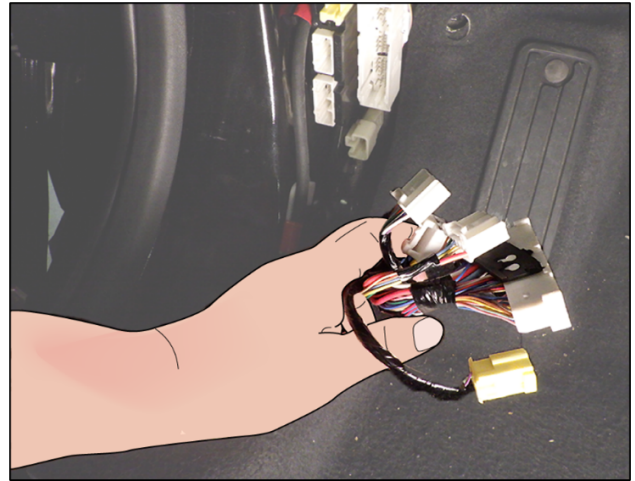

**STEP 6:** Remove the two heater ground bolts.

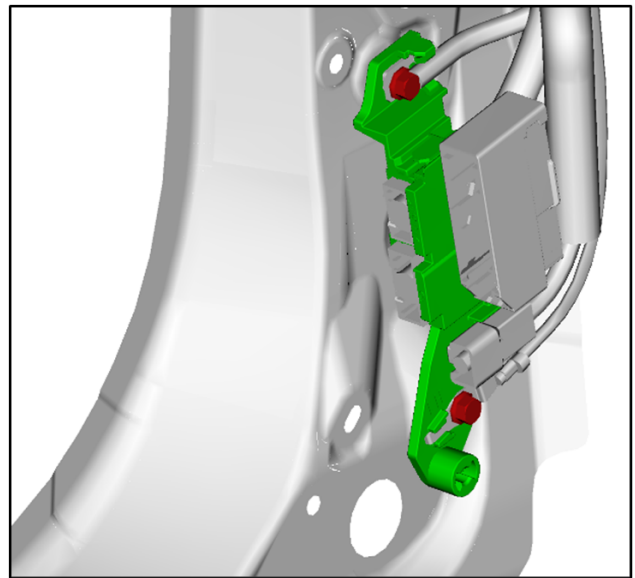

**STEP 7:** Release the connector holder cover mounting clip security tabs.

**CAUTION:** To prevent any damage, **DO NOT** attempt to remove the connector holder **WITHOUT** releasing the security tabs first.

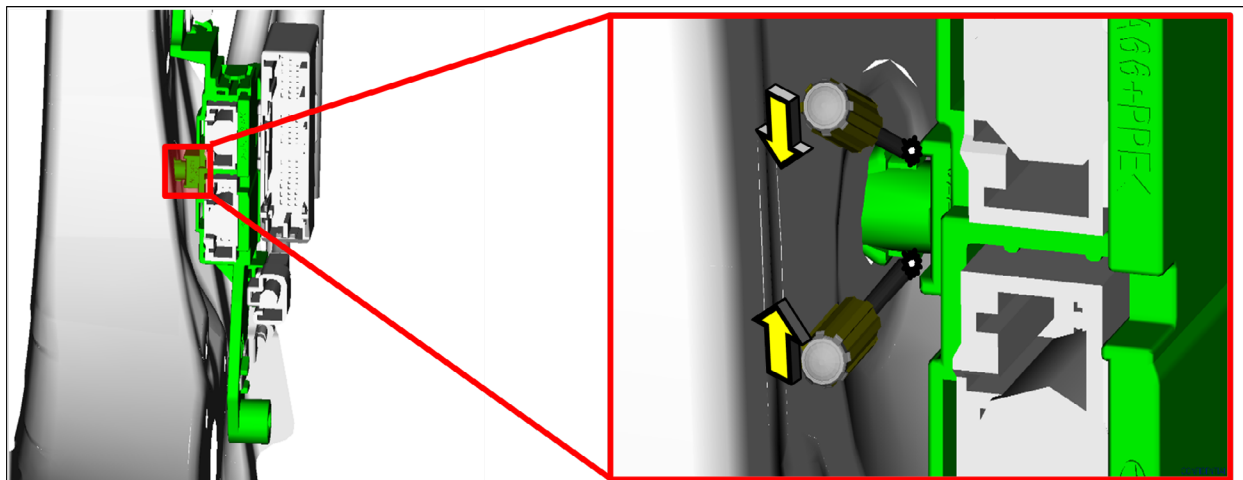

*Continued...*

**STEP 8:** Move the connector holder aside to allow room for workspace.

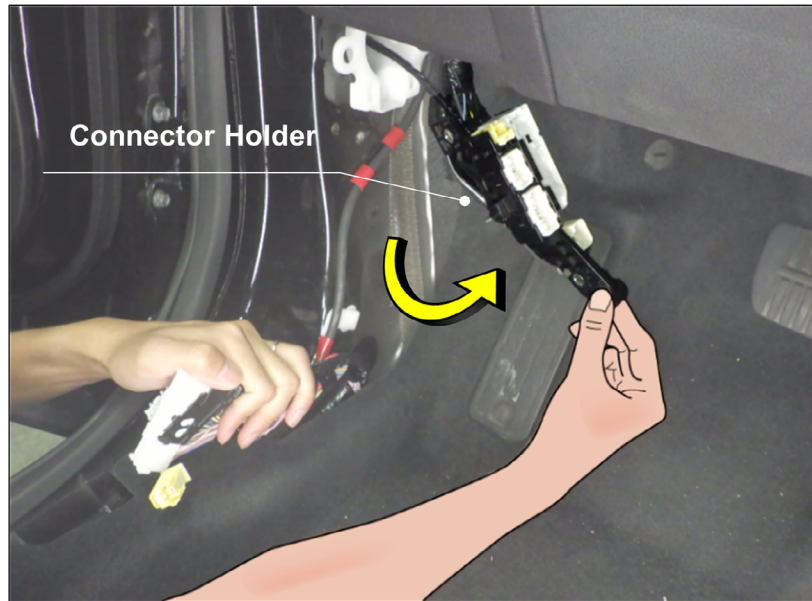

**STEP 9:** Thread the thread chaser into both of the ground bolt holes. Use a torque wrench to turn the thread chaser. If the turning torque is 7Nm or higher, clean the threads with a tap and recheck the turning torque. Once the turning torque is less than 7Nm, continue to the next STEP.

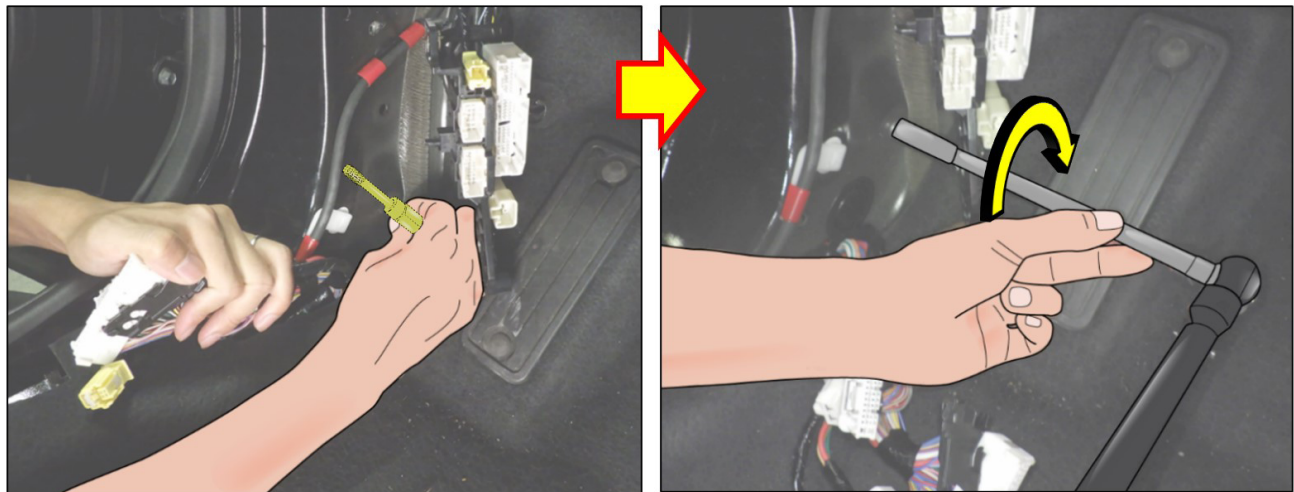

*Continued...*

**STEP 10:** Using a small flat head screwdriver, release the holding claw on the back of the connector holder. With the claw released, remove the PTC heater ground terminal from the connector holder.

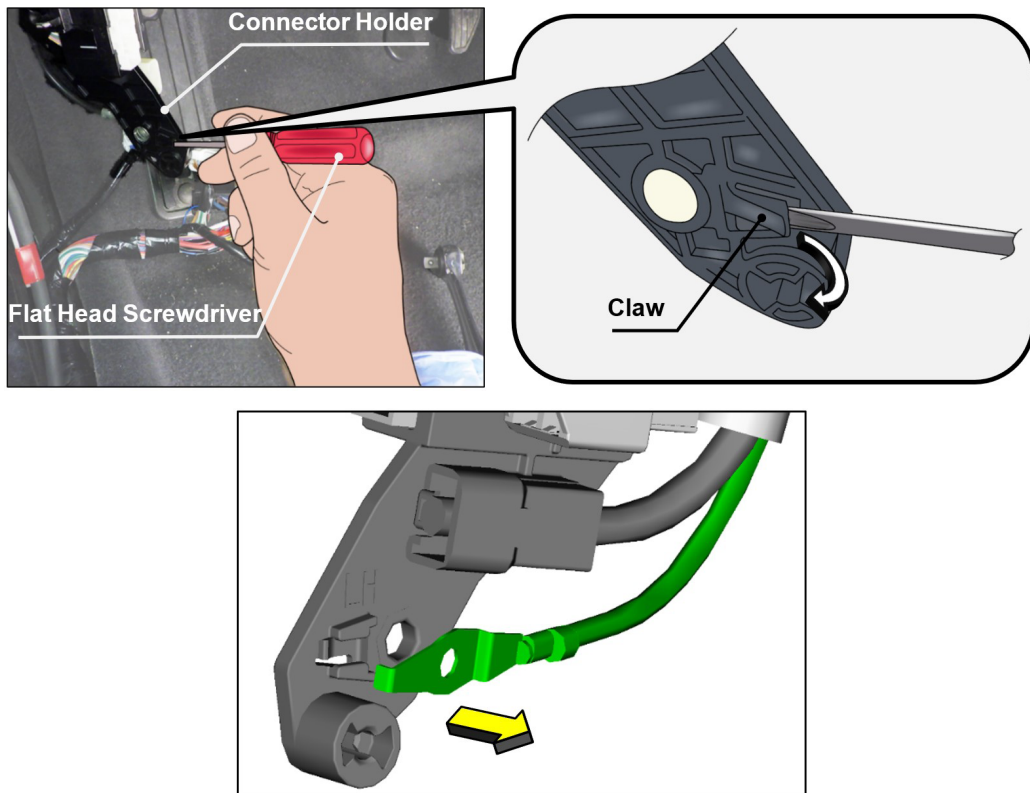

**STEP 11: CAREFULLY** inspect the PTC heater ground terminal and peripheral parts for any damage. See the example images of overheat damage below.

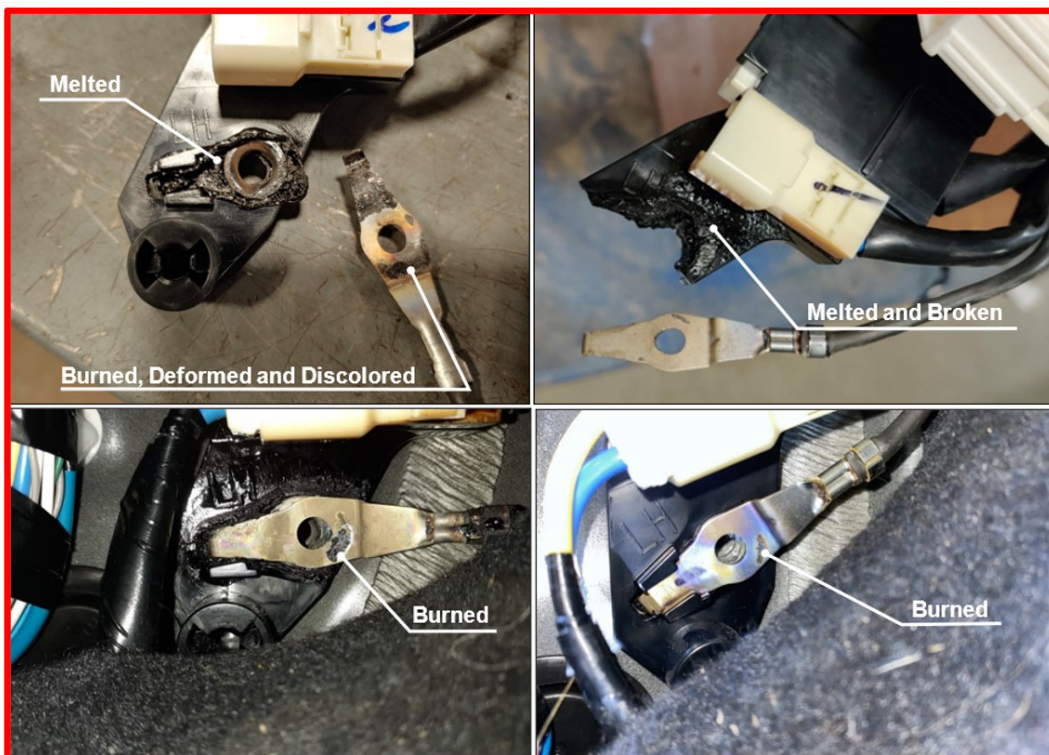

**IMPORTANT:** If any damage is found, a QMR will be required with detailed photos of the damage attached and the repair parts order information noted in the comments section.

*Continued...*

**STEP 12:** Has any damage been found with the PTC heater ground terminal and/or the peripheral parts?

**YES** – Proceed to STEP 13.

**NO** – Proceed to STEPS 25, 26, & 27. Then proceed to STEP 33.

**STEP 13:** Pull the front left side cover in the horizontal direction to release the holding claws. Once released remove the cover.

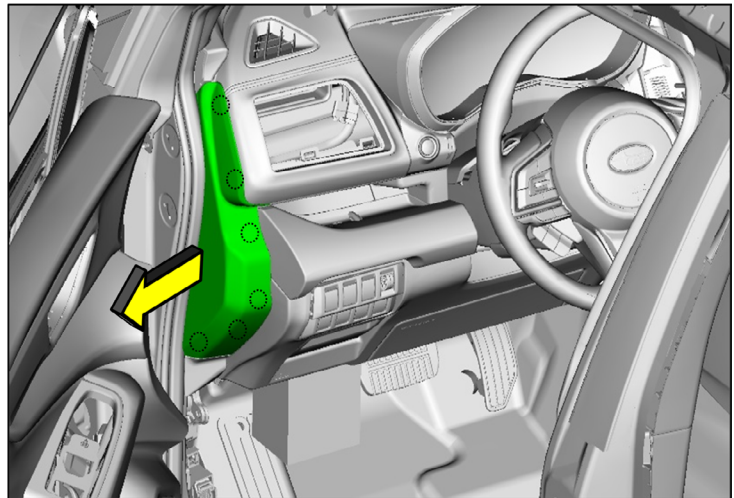

**STEP 14:** CAREFULLY pull the trim panel toward the rear of the vehicle to release the mounting claws. Once released, remove the panel.

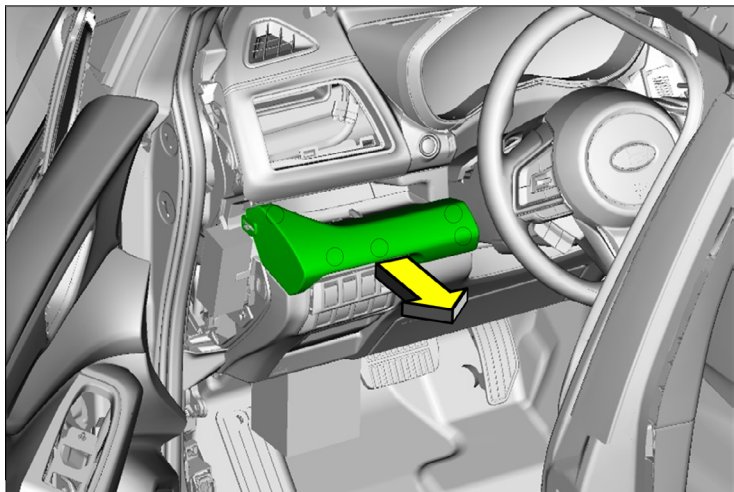

**STEP 15:** Remove the mounting screw and pull the lower cover toward the rear of the vehicle to release the mounting clips. Once released, disconnect all electrical connections and remove the panel.

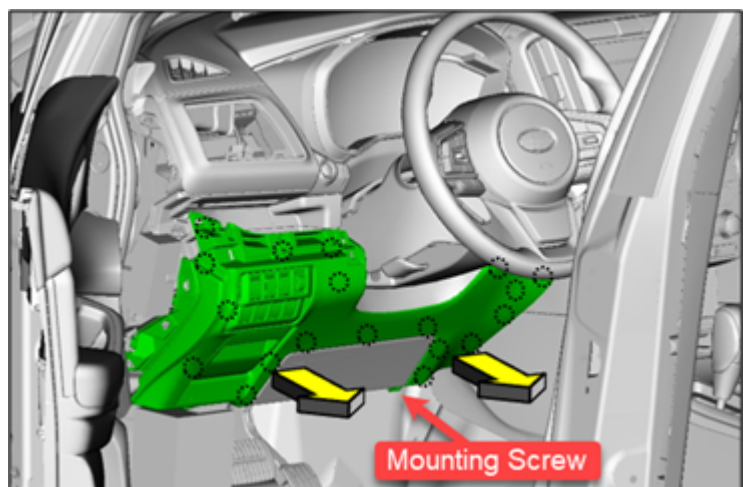

*Continued...*

**STEP 16:** Disconnect the data link connector. Disconnect the knee airbag module connector. **CAREFULLY** remove the knee airbag module.

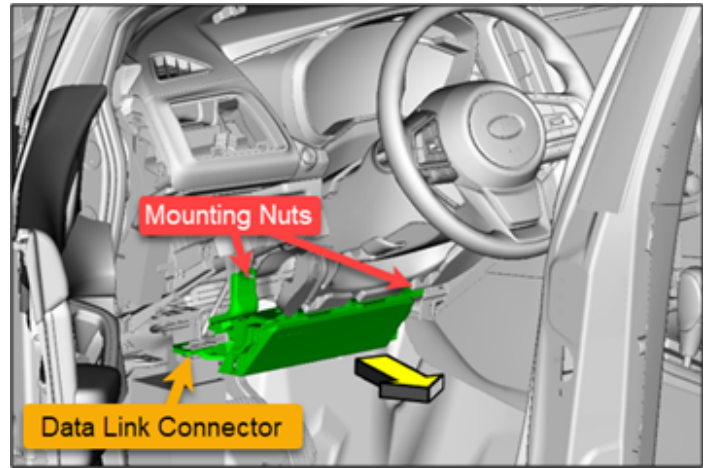

**STEP 17:** Remove the mounting screw. Release the mounting claws. Remove the duct by pulling in the direction of the left front door.

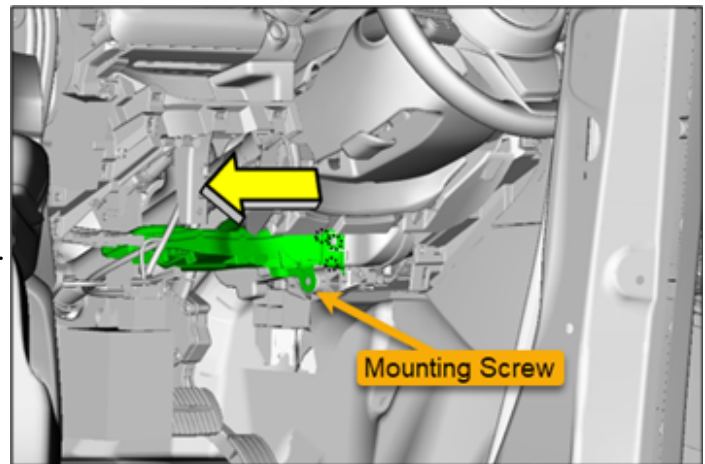

**STEP 18:** Disconnect the electrical connections at the front of the fuse box. Remove the mounting nuts and screw. Move the fuse box toward the floor to allow for workspace.

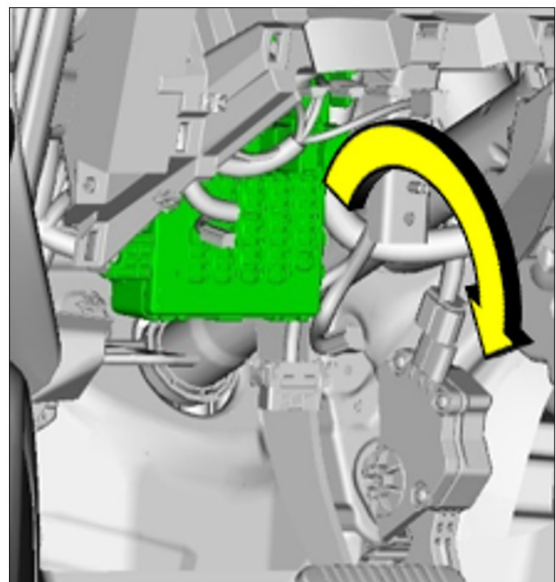
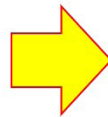
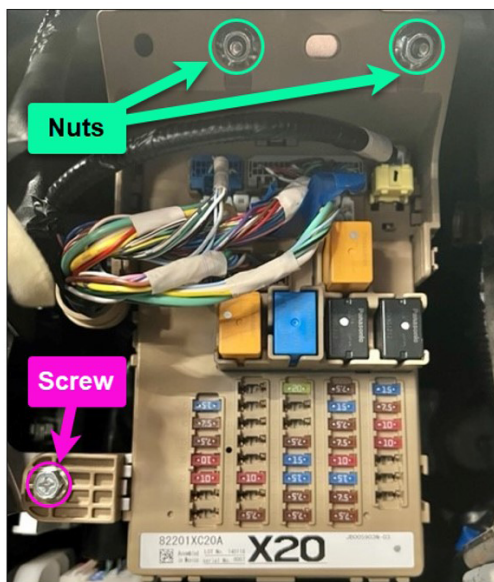

*Continued...*

**STEP 19:** Using needle nose pliers, pinch the claw of the connector holder and remove the ground terminal.

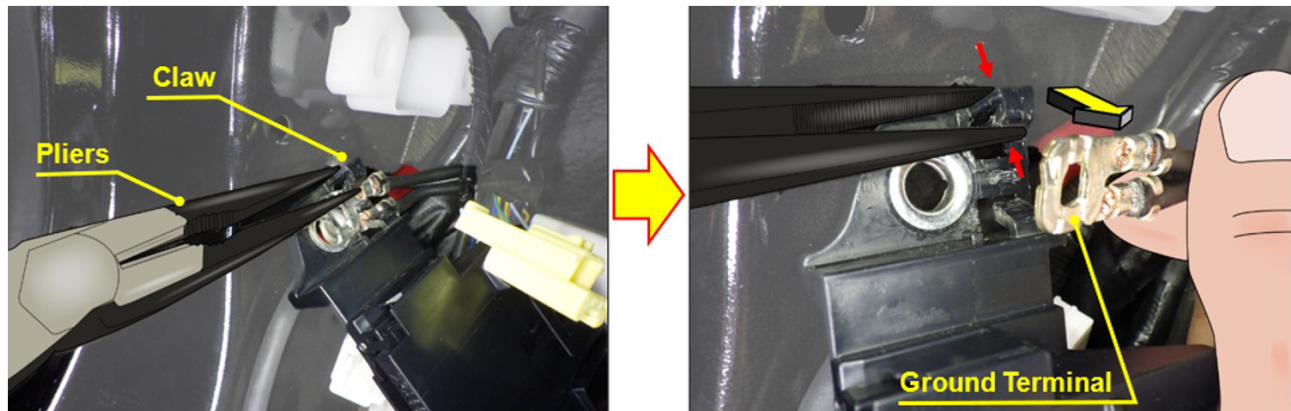

**STEP 20:** Release the locking tab using a flathead screwdriver. Disconnect all electrical connections and remove the connector holder.

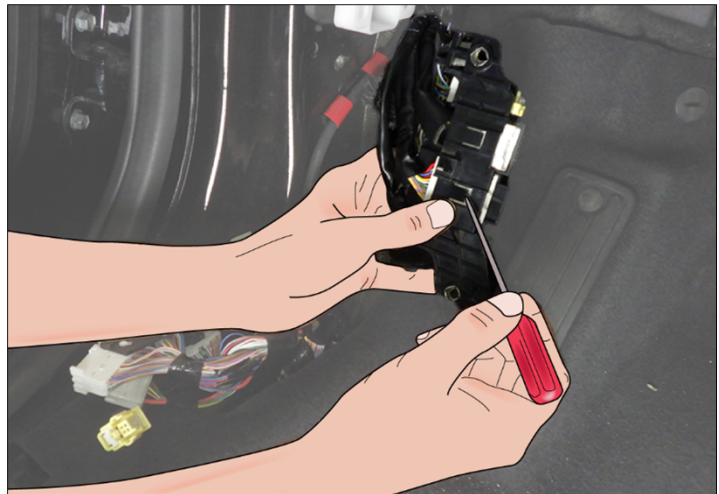

**STEP 21:** Install the new connector holder supplied in harness kit (SOA635175). Connect all the electrical connections in the reverse order of disassembly. Secure the connector holder to the vehicle body with the mounting clip.

**CAUTION:** DO NOT install the mounting bolts at this time.

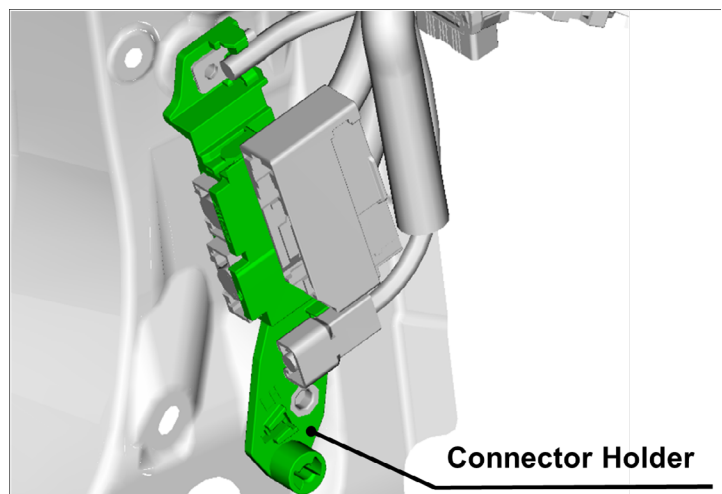

*Continued...*

**STEP 22:** Disconnect the original ground wire connection. Connect the new ground harness supplied in the harness kit (SOA635175).

**NOTE:** The original ground wire will remain in place. The ends will be trimmed in later STEPS.

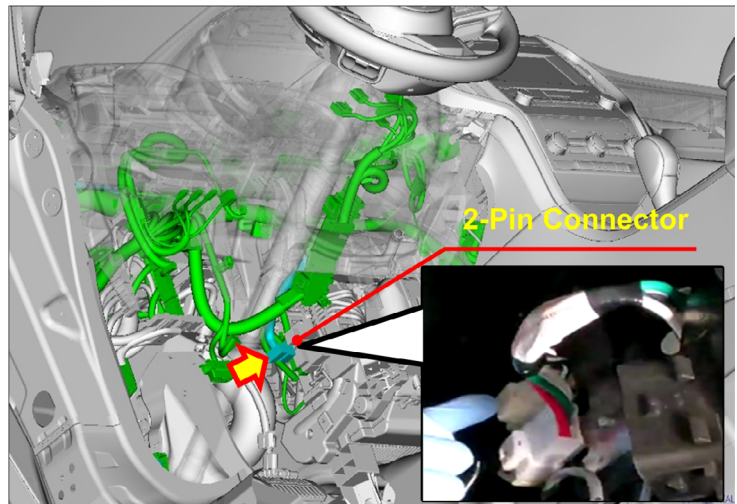

**STEP 23:** Route the new ground wire along the instrument panel harness as shown below.

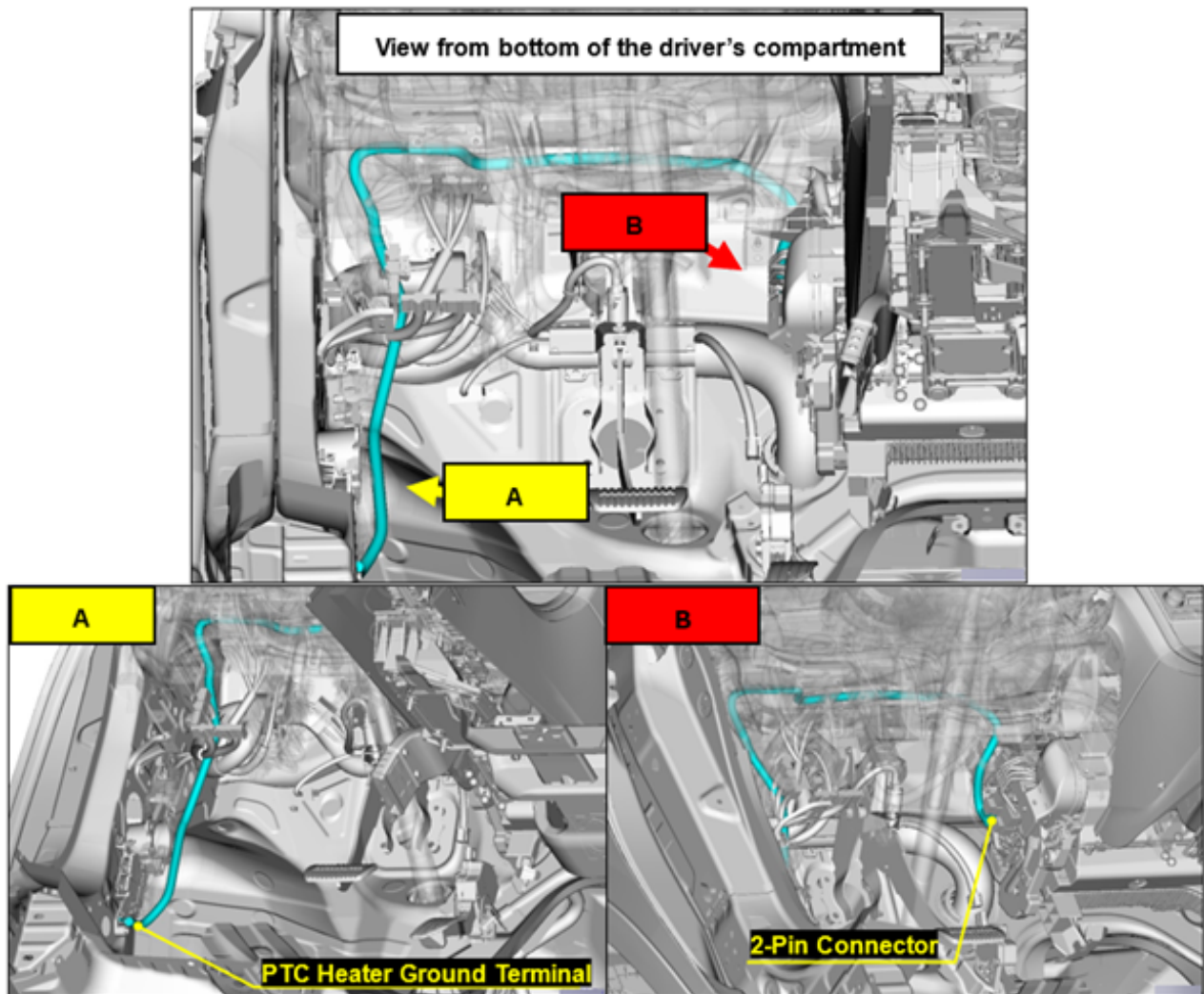

*Continued...*



**STEP 24:** Align and attach the ground terminal of the new ground wire to the connector holder.

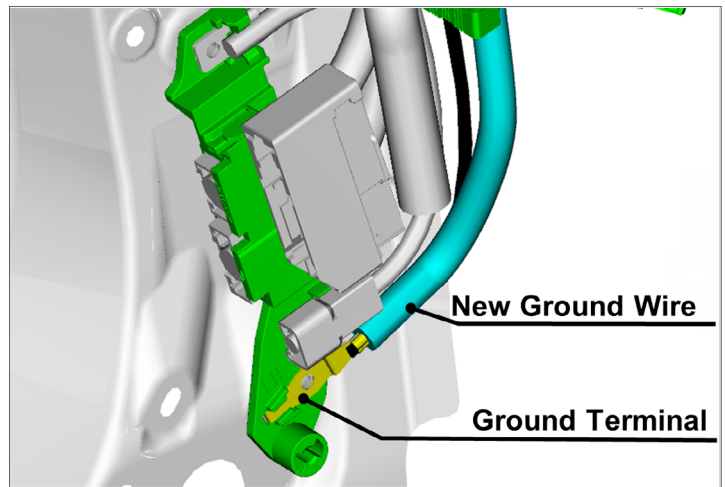

**STEP 25:** Install the new ground bolts and torque to 13Nm.

**IMPORTANT:** CONFIRM bolts are torqued to 13Nm.

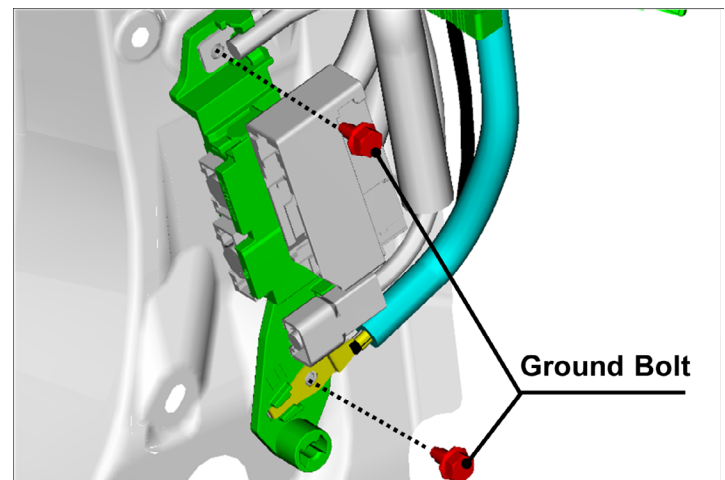

**STEP 26:** Confirm there is no movement with the ground terminal. Check for any loose contact by attempting to move the terminal with your fingers in an up/down direction. There is no need to pull the ground cable when checking for loose contact.

**CAUTION:** Any loose connection could cause a possible thermal event.

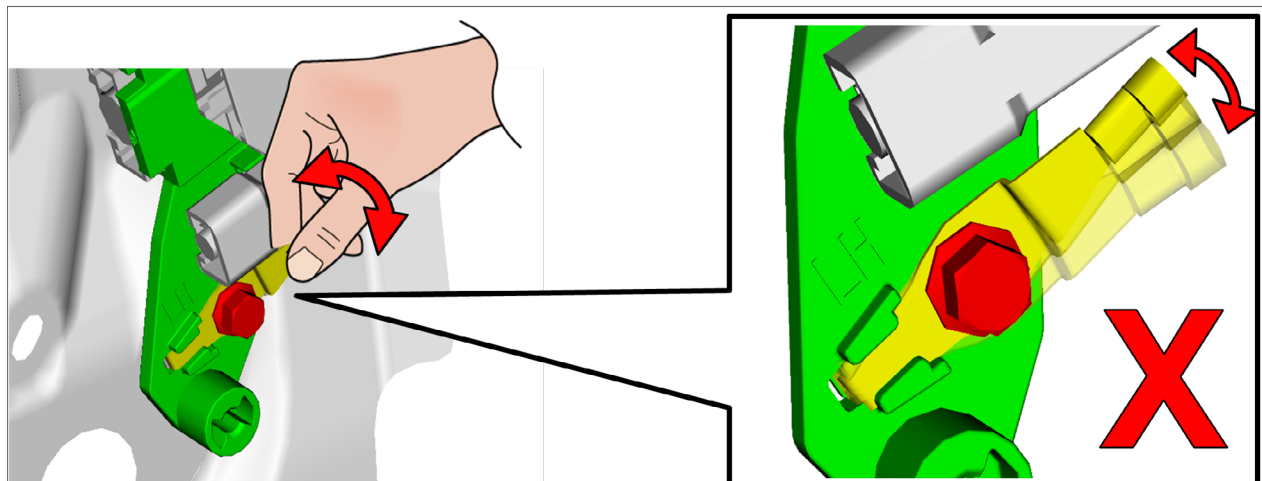

*Continued...*

**STEP 27:** Connect all the previously removed connectors to the connector holder.

**NOTE:** If performing bolt replacement **ONLY**, proceed to STEP 33.

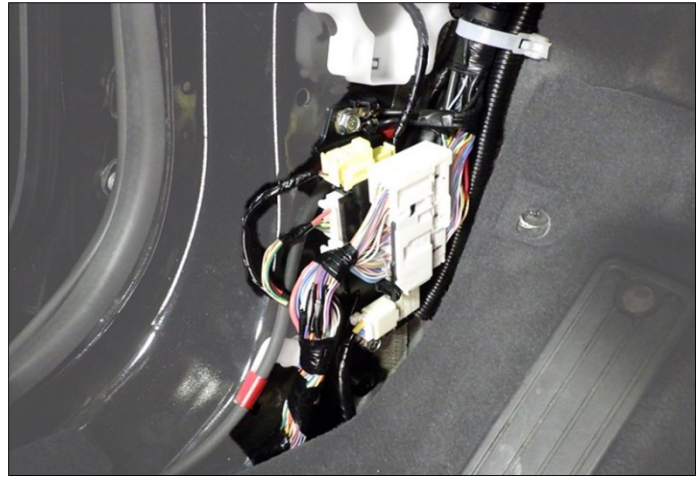

**STEP 28:** Using cable ties, secure the new ground wire at the six locations indicated in the images below. The original harness wire strap locations can be used as reference. Confirm the tension of the ground wire is evenly distributed.

**NOTE:** 12-inch wire straps are recommended for the best results.

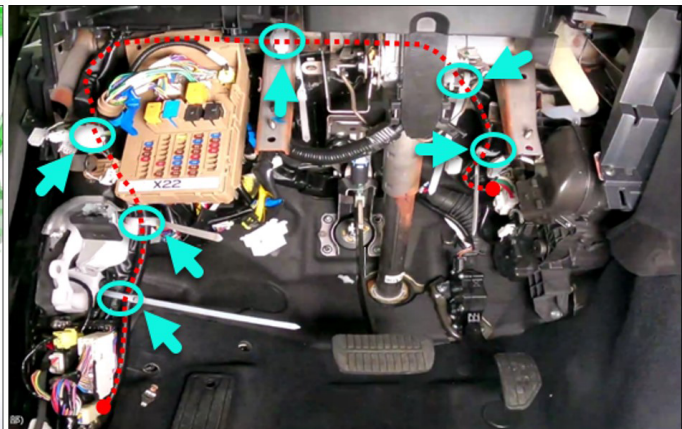
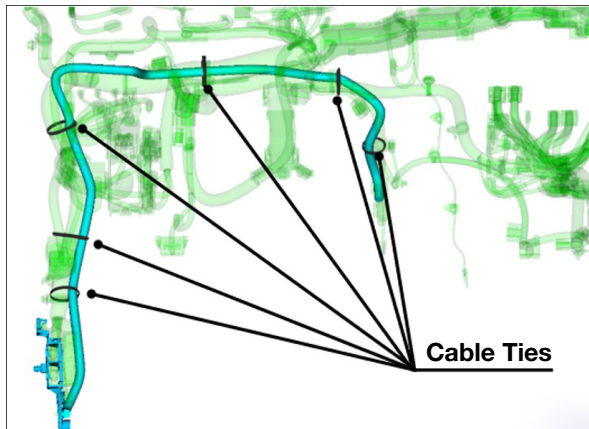

**CAUTION:** Always trim the edges of the cable ties to prevent any interference with other parts.

**STEP 29:** Using side cutting pliers, **CAREFULLY** cut the **ORIGINAL** ground wire and remove the terminal.

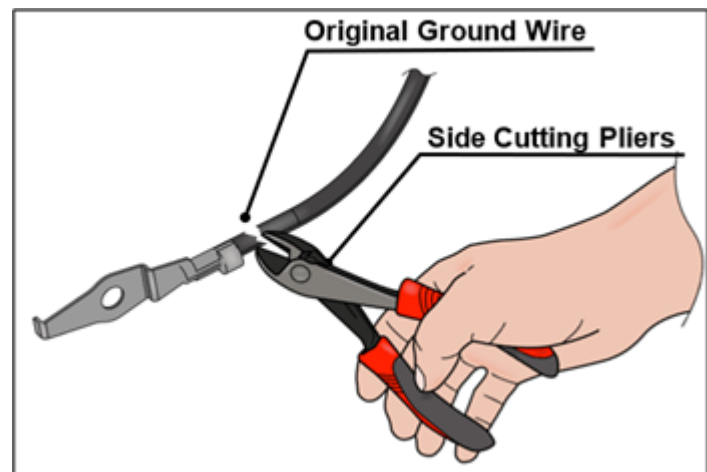

*Continued...*

**STEP 30:** Seal the cut end of the original ground wire with electrical insulation tape. The wire can then be taped to the new ground wire.

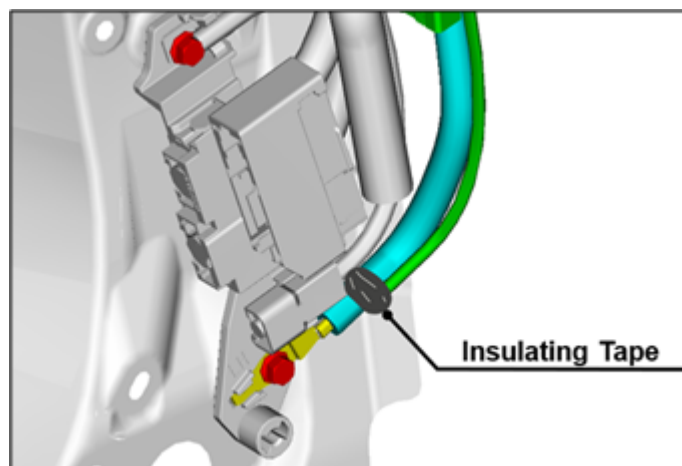

**STEP 31:** Cut the opposite end of the ORIGINAL ground wire and remove the connector.

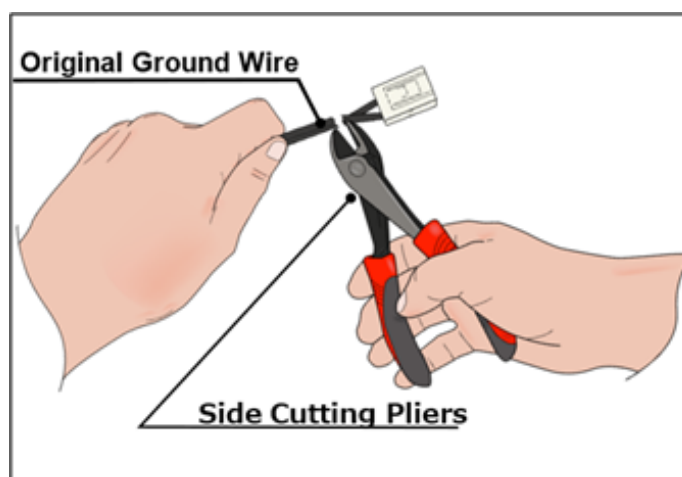

**STEP 32:** Seal the cut end of the original ground wire with electrical insulation tape. The wire can then be taped to the new ground wire.

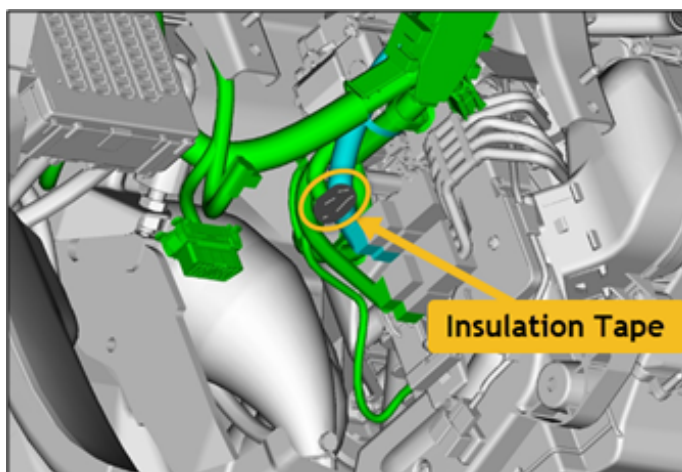

**STEP 33:** Reinstall all removed parts in the reverse order of disassembly.

**IMPORTANT:** Whenever reconnecting the ground cable terminal to the battery sensor, torque to 7.5Nm (5.5ft.-lbs. or 66inch.-lbs.) while supporting the sensor with the other hand as outlined in the applicable Service Manual under: STARTING/CHARGING SYSTEMS > Battery Sensor.

*Continued...*

## SERVICE PROGRAM IDENTIFICATION LABEL:

Type or print the necessary information on a Campaign Identification Label. The completed label should be attached to the vehicle's upper radiator support. Additional labels are available through normal parts ordering channels. The part number is **MSA6P1302**, which comes as one sheet of 20 labels.

Part Number	Applicability	Description	Order Quantity
MSA6P1302	All Models	Campaign Completion Labels (contains one sheet of 20 labels)	1

<b>SUBARU</b>
Campaign Code
<b>WRL-22</b>
COMPLETED
DIST./DEALER NO.
SERIAL NO.
<b>DO NOT REMOVE</b>

## CLAIM REIMBURSEMENT AND ENTRY PROCEDURES:

Credit to perform this recall will be based on properly completed repair order information. Retailers may submit claims through [Subarunet.com](http://Subarunet.com).

Labor Description	Labor Operation #	Labor Time	Fail Code
Inspect & Chase and/or Tap Threads	A125-151	0.5	WRL-22
Inspect, Chase & or Tap, Install Harness*	A125-152	0.8	

\*A QMR identification number must be noted on the repair order as this information is required for entry in the Miscellaneous Detail field during claim submission.

\*Up to \$1.00 can be claimed in sublet for wire straps and insulation tape used during this repair.

\*Clear photos of the damage **MUST** be included as an attachment when submitting claims. Failure to include a photo will affect claim processing and payment.

## IMPORTANT REMINDERS:

- SOA strongly discourages the printing and/or local storage of service information as previously released information and electronic publications may be updated at any time.
- Always check for any open recalls or campaigns anytime a vehicle is in for servicing.
- Always refer to STIS for the latest service information before performing any repairs.

*Continued...*