



David J. Johnson
 Director
 Service Engineering Operations
 Ford Customer Service Division

Ford Motor Company
 P. O. Box 1904
 Dearborn, Michigan 48121

August 15, 2022

TO: All U.S. Ford and Lincoln Dealers

**SUBJECT: NEW VEHICLE DEMONSTRATION / DELIVERY HOLD -
 Safety Recall 22S53**

Certain 2021-2022 Model Year F-150 Vehicles Equipped with Crew Cab, 145" Wheelbase, 4x4, One-Piece Aluminum Driveshaft, and MFAL BHDAA (Less Sound Insulation Packs)* Loose/Sagging Underbody Insulators

*This corresponds to Equipment Packages XL & XLT 301A and below, and Tremor 400A.

AFFECTED VEHICLES

Vehicle	Model Year	Assembly Plant	Build Dates
F-150	2021-2022	Dearborn	January 22, 2020 through November 2, 2021
F-150	2021-2022	Kansas City	June 1, 2020 through October 15, 2021

The eleventh VIN position is the assembly plant code.

- F - Dearborn Assembly (Dearborn, Michigan) = DTP
- K - Kansas City Assembly (Claycomo, Missouri) = KCAP

Affected vehicles are identified in OASIS and FSA VIN Lists.

REASON FOR THIS SAFETY RECALL

In some of the affected vehicles, underbody insulators may have been installed in error. If installed, the underbody insulators may loosen and contact the aluminum driveshaft, resulting in marking or scoring of the driveshaft. Over time, the aluminum driveshaft may fracture, which can result in loss of motive power while driving, unintended vehicle movement while the vehicle is in park if the parking brake is not applied, and secondary damage to surrounding components. A fractured driveshaft may also contact the ground which may cause loss of control of the vehicle while driving. A fractured driveshaft increases the risk of injury or crash.

SERVICE ACTION

Before demonstrating or delivering any new in-stock vehicles involved in this recall, dealers will inspect if either the driver or passenger-side underbody insulator(s) are present. If either underbody insulator is present, the dealer will secure the underbody insulator(s) and inspect the driveshaft, fuel vapor lines and electrical connectors for damage and repair as required. This service must be performed on all affected vehicles at no charge to the vehicle owner.

OWNER NOTIFICATION MAILING SCHEDULE

Owner letters are expected to be mailed the week of September 5, 2022. Dealers should repair any affected vehicles that arrive at their dealerships, whether or not the customer has received a letter.

PLEASE NOTE:

Federal law requires dealers to complete this recall service before a new vehicle is delivered to the buyer or lessee. Violation of this requirement by a dealer could result in a civil penalty of up to \$21,000 per vehicle. Correct all vehicles in your new vehicle inventory before delivery.

ATTACHMENTS

Attachment I: Administrative Information
Attachment II: Labor Allowances and Parts Ordering Information
Attachment III: Technical Information
Owner Notification Letters
Recall Reimbursement Plan

QUESTIONS & ASSISTANCE

For questions and assistance, contact the Special Service Support Center (SSSC) via the SSSC Web Contact Site. The SSSC Web Contact Site can be accessed through the Professional Technician System (PTS) website using the SSSC link listed at the bottom of the OASIS VIN report screen or listed under the SSSC tab.

Sincerely,

A handwritten signature in cursive script that reads "D. Johnson".

David J. Johnson

**NEW VEHICLE DEMONSTRATION / DELIVERY HOLD -
Safety Recall 22S53**

Certain 2021-2022 Model Year F-150 Vehicles Equipped with Crew Cab, 145" Wheelbase, 4x4, One-Piece Aluminum Driveshaft, and MFAL BHDAA (Less Sound Insulation Packs)
Loose/Sagging Underbody Insulators

OASIS ACTIVATION

OASIS will be activated on August 15, 2022.

FSA VIN LISTS ACTIVATION

FSA VIN Lists will be available through <https://web.fsavinlists.dealerconnection.com> on August 15, 2022.

Owner names and addresses will be available by September 16, 2022.

NOTE: Your FSA VIN Lists may contain owner names and addresses obtained from motor vehicle registration records. The use of such motor vehicle registration data for any purpose other than in connection with this recall is a violation of law in several states, provinces, and countries. Accordingly, you must limit the use of this listing to the follow-up necessary to complete this recall.

SOLD VEHICLES

- Ford has not issued instructions to stop selling/delivering or driving used vehicles under this safety recall. Owners should contact their dealer for an appointment to have their vehicles remedied as soon as practicable. Owners can continue to safely drive their vehicles.
- Immediately contact any of your affected customers whose vehicles are not on your VIN list but are identified in OASIS. Give the customer a copy of the Owner Notification Letter (when available) and schedule a service date.
- Correct other affected vehicles identified in OASIS which are brought to your dealership.
- Dealers are to prioritize repairs of customer vehicles over repairs of new and used vehicle inventory.

STOCK VEHICLES

- Correct all affected units in your new vehicle inventory before delivery.
- Use OASIS to identify any affected vehicles in your used vehicle inventory.

DEALER-OPERATED RENTAL VEHICLES

The Fixing America's Surface Transportation (FAST) Act law effective June 2016 prohibits a rental company from selling, renting or leasing vehicles subject to a safety or compliance recall. Please consult your legal counsel for legal advice.

TITLE BRANDED / SALVAGED VEHICLES

Affected title branded and salvaged vehicles are eligible for this recall.

**NEW VEHICLE DEMONSTRATION / DELIVERY HOLD -
Safety Recall 22S53**

Certain 2021-2022 Model Year F-150 Vehicles Equipped with Crew Cab, 145" Wheelbase, 4x4, One-Piece Aluminum Driveshaft, and MFAL BHDAA (Less Sound Insulation Packs)
Loose/Sagging Underbody Insulators

OWNER REFUNDS

- **This safety recall must still be performed, even if the owner has paid for a previous repair. Claiming a refund will not close the recall on the vehicle.**
- Ford Motor Company is offering a refund for owner-paid repairs covered by this recall if the repair was performed prior to the date indicated in the reimbursement plan, which is posted with this bulletin. Owners are directed to seek reimbursement through authorized dealers or, at their option, directly through Ford Motor Company at P.O. Box 6251, Dearborn, MI 48121-6251.
- Dealers are also pre-approved to refund owner-paid emergency repairs that were performed away from an authorized servicing dealer after the end date specified in the reimbursement plan. Non-covered repairs, or those judged by Ford to be excessive, will not be reimbursed.
- Refunds will only be provided for the cost associated with driveshaft replacement.

RENTAL VEHICLES

- **PASS INSPECTION:** Vehicles that pass the applicable driveshaft, fuel systems, and electrical inspections are **NOT** affected and are not approved for rental vehicles. Refer to the 22S53 technical instructions for additional information.
- **FAIL INSPECTION:** Vehicles that fail either the applicable driveshaft, fuel systems, or electrical inspections
 - **Parts are NOT available:**
 - ✓ Driveshaft, vapor line, or pigtail is on back-order.
 - ✓ PARTS ESCALATION PROCESS (Vehicle Off Road) process has been followed and COPIS ticket with VOR flagged has been submitted.
 - ✓ Prior approval is required from the SSSC, submit contact type long-term rental for consideration and approval if appropriate.
- **A ten-digit prior-approval code is required from the SSSC for rental vehicles,** a new approval code is required from SSSC every 30 days.
- If rental vehicles are needed beyond December 31, 2022, dealers will have to contact SSSC for an extension.
- Approval for all rental vehicles for this program will end on December 31, 2022.
- Follow Extended Service Plan (ESP) guidelines for dollar amounts. Prior approval is required from the SSSC.

VEHICLE DEMONSTRATION / DELIVERY HOLD -**Safety Recall 22S53**

Certain 2021-2022 Model Year F-150 Vehicles Equipped with Crew Cab, 145" Wheelbase, 4x4, One-Piece Aluminum Driveshaft, and MFAL BHDAA (Less Sound Insulation Packs)
Loose/Sagging Underbody Insulators

ADDITIONAL REPAIR (LABOR TIME AND/OR PARTS)

Additional repairs identified as necessary to complete the FSA should be managed as follows:

- For related damage and access time requirements, refer to the Warranty and Policy Manual / Section 6 – Ford & Lincoln Program Policies / General Information & Special Circumstances for FSA's / Related Damage.
- For vehicles within new vehicle bumper-to-bumper warranty coverage, no SSSC approval is required, although related damage must be on a separate repair line with the "Related Damage" radio button checked.
 - Ford vehicles – 3 years or 36,000 miles
- For vehicles outside new vehicle bumper-to-bumper warranty coverage, submit an Approval Request to the SSSC Web Contact Site prior to completing the repair.

CLAIMS PREPARATION AND SUBMISSION

- **Claim Entry:** Enter claims using Dealer Management System (DMS) or One Warranty Solution (OWS) online.
 - When entering claims, select claim type 31: Field Service Action. The FSA number 22S53 is the sub code.
 - For additional claims preparation and submission information, refer to the Recall and Customer Satisfaction Program (CSP) Repairs in the OWS User Guide.
- **Related Damage/Additional labor and/or parts:** Must be claimed as Related Damage on a separate repair line from the FSA with same claim type and sub code as described in Claim Entry above.
IMPORTANT: Click the Related Damage Indicator radio button.
- **Rentals:** For rental vehicle claiming, follow Extended Service Plan (ESP) guidelines for dollar amounts. Enter the total amount of the rental expense under Miscellaneous Expense code RENTAL.
- **Refunds:** Submit refunds on a separate repair line.
 - Program Code: 22S53 - Misc. Expense: ADMIN
 - Misc. Expense: REFUND - Misc. Expense: 0.2 Hrs.
 - Multiple refunds should be submitted on one repair line and the invoice details for each repair should be detailed in the comments section of the claim.
- **Provision for Misc. Expense:** Provision for Misc. Expense: Washers and Loctite 243 as needed.
 - Program Code: 22S53
 - Misc. Expense: OTHER
 - Amount: Actual cost up to \$15.00

**VEHICLE DEMONSTRATION / DELIVERY HOLD -
Safety Recall 22S53**

Certain 2021-2022 Model Year F-150 Vehicles Equipped with Crew Cab, 145" Wheelbase, 4x4, One-Piece Aluminum Driveshaft, and MFAL BHDAA (Less Sound Insulation Packs)*
Loose/Sagging Underbody Insulators

LABOR ALLOWANCES

Description	Labor Operation	Labor Time
Inspect for presence of both driver-side and passenger-side underbody insulators, none are present, no rivets installed.	22S53A	0.3 Hours
<p><u>Parts are available to complete repair:</u></p> <ol style="list-style-type: none"> Retrieve DTC's (gas engine only) Inspect both underbody insulators for contact with driveshaft, fuel vapor lines for gas engine and coolant sensor wiring for hybrid. Drill 2 holes (KCAP vehicles) or 5 holes (DTP vehicles) and install corresponding # of rivets and washers to secure insulators. Clean four driveshaft bolts and apply <p>Note: Includes time to remove, and install or replace driveshaft</p> <p>Note: Hybrid Vehicles should claim labor operation code 22S53H or 22S53HH</p>	22S53B	0.9 Hours
<p><u>Driveshaft Replacement Necessary, part on back-order (this will not close recall):</u></p> <ol style="list-style-type: none"> Retrieve DTC's (gas engine only) Inspect both underbody insulators for contact with driveshaft, fuel vapor lines for gas engine and coolant sensor wiring for hybrid. Drill 2 holes (KCAP vehicles) or 5 holes (DTP vehicles) and install corresponding # of rivets and washers to secure insulators. Clean four driveshaft bolts and apply <p>Notes:</p> <ul style="list-style-type: none"> Includes time to remove, and install or replace driveshaft Hybrid Vehicles should claim labor operation code 22S53H or 22S53HH This should only be claimed if driveshaft is on back-order, COPIS ticket submitted, VOR flagged, SSSC 10 digit approval code required If driveshaft fails inspection criteria, vehicles should not be returned to customer to continue to drive Can only be claimed with MT22S53C, 22S53ZZ and 22S53K 	22S53BB	0.9 Hours
<p>Gas engine only:</p> <ul style="list-style-type: none"> Diagnose DTC P0442 and/or P0456 (PPT and inspection) Remove fuel tank for additional inspection (if necessary) Repair damage to vapor lines caused by the underbody insulator 	MT22S53C	Up to 2.0 Hours

**VEHICLE DEMONSTRATION / DELIVERY HOLD -
Safety Recall 22S53**

Certain 2021-2022 Model Year F-150 Vehicles Equipped with Crew Cab, 145" Wheelbase, 4x4, One-Piece Aluminum Driveshaft, and MFAL BHDAA (Less Sound Insulation Packs)
Loose/Sagging Underbody Insulators

LABOR ALLOWANCES (continued)

Hybrid – Repair damaged coolant sensor wiring cause by underbody insulator	MT22S53D	Up to 1.0 Hour
Time allowed to submit photos (required for driveshaft, vapor lines, electrical, underbody insulators, and other related damage) NOTE: This labor operation code will be deactivated once parts are available open order.	22S53ZZ	0.2 Hours
<u>Parts are available to complete repair:</u> Hybrid -- Inspect drive shaft, remove drive shaft, remove under shield/clean, install one rivet and install drive shaft. (Can only be claimed with MT22S53D and 22S53ZZ)	22S53H	1.1 Hours
<u>Driveshaft Replacement Necessary, part on back-order (this will not close recall):</u> Hybrid -- Inspect drive shaft, remove drive shaft, remove under shield/clean, install one rivet and install drive shaft (Can only be claimed with MT22S53D, 22S53ZZ, and 22S53K)	22S53HH	1.1 Hours
All - Vehicle returns for driveshaft replacement (This labor operation code cannot be claimed with 22S53B or 22S53H)	22S53K	0.4 Hours

**NEW VEHICLE DEMONSTRATION / DELIVERY HOLD -
Safety Recall 22S53**

Certain 2021-2022 Model Year F-150 Vehicles Equipped with Crew Cab, 145" Wheelbase, 4x4, One-Piece Aluminum Driveshaft, and MFAL BHDAA (Less Sound Insulation Packs)
Loose/Sagging Underbody Insulators

PARTS REQUIREMENTS / ORDERING INFORMATION

SSSC Web Contact Site:

Parts are not yet available to repair all vehicles. Until parts are available to repair all vehicles, dealers may only order parts and repair vehicles, which are customer-owned vehicles currently in the dealership and unsold vehicles with a signed sales contract.

- To place an order for the following parts, submit a VIN-specific Part Order contact via the SSSC Web Contact Site - three or more photos as required per the technical instructions.
 - Door label with VIN
 - Odometer showing mileage of vehicle
 - Review the updated technical instructions and provide photos as requested for each step the driveshaft fails the inspection process.
- Any unsold vehicles must include a copy of the signed sales contract.

Driveshaft - Only replace the driveshaft if marks are present per the technical instructions.

Part Number	Description	Order Quantity
-4602-	Driveshaft (part number varies by vehicle – use Ford ECat to identify the specific part number by VIN)	As Required

Dealers will be notified via a DOES II communication if circumstances warrant a change in part supply strategy and when open ordering resumes.

NOTE: The Driveshaft flange to pinion flange bolt part number N800594-S100 has been removed from the parts list for this program, and may be reused. Refer to the 22S53 Technical Information on updated instructions for thread cleaning and application of thread adhesive.

Order the parts below through normal order processing channels:

Rivet Part Number's	Description	Order Quantity	Claim Quantity
Any of the following part numbers may be used: <ul style="list-style-type: none"> • W702554-S900 • W702554-S437 • W708777-S900C • W719880-S417 	Rivets (Pack of 4, 5 needed per DTP vehicles, 2 needed per KCAP vehicles) NOTE: Part numbers ending in S900C are packages of 100	2 DTP	5 Rivets
		1 KCAP	2 Rivets

**NEW VEHICLE DEMONSTRATION / DELIVERY HOLD -
Safety Recall 22S53**

Certain 2021-2022 Model Year F-150 Vehicles Equipped with Crew Cab, 145" Wheelbase, 4x4, One-Piece Aluminum Driveshaft, and MFAL BHDAA (Less Sound Insulation Packs)
Loose/Sagging Underbody Insulators

Repair	Part Number	Description	Order Quantity	Claim Quantity
All	PM-13-B or Equivalent (use OSP)	Motorcraft Anti-Corrosion Coating (16 fl. Oz per container, applied to all rivets liberally, 2 Oz. per repair, repair 8 vehicles per can) Check dealer inventory before ordering additional quantities	As Needed	0.13
All	TA-2-B or Equivalent (use OSP)	Motorcraft Seam Sealer (9.5 fl. Oz per tube, applied to all rivets liberally, 1 Oz per rivet, 1-5 Oz per vehicle, repair 1-5 vehicles per tube) Check dealer inventory before ordering additional quantities	As Needed	0.11 each rivet 0.5 maximum per repair

Driveshaft Replacement	XG-1-E1	Motorcraft® Premium Long-Life Grease	1	As Required
Driveshaft Replacement	XT-10-QLVC	MERCON® LV Automatic Transmission Fluid (12 per case, 1 Quart bottle required)	1	1 Quart

To guarantee the shortest delivery time, an emergency order for parts must be placed.

Obtain the parts below locally:

Part Number	Description	Quantity Needed
Obtain Locally	Zinc coated steel or Aluminum washers, ¼ inch ID, 2-inch OD, Thickness 2mm (Max).	5 needed per <u>DTP</u> Vehicle Claim as Misc. Other
		2 needed per <u>KCAP</u> Vehicle Claim as Misc. Other
Obtain Locally	LOCTITE 243 Blue Medium Strength Threadlocker or equivalent – Specification WSK-M2G349-A7	1 tube needed per vehicle Claim as Misc. Other

**NEW VEHICLE DEMONSTRATION / DELIVERY HOLD -
Safety Recall 22S53**

Certain 2021-2022 Model Year F-150 Vehicles Equipped with Crew Cab, 145" Wheelbase, 4x4, One-Piece Aluminum Driveshaft, and MFAL BHDAA (Less Sound Insulation Packs)
Loose/Sagging Underbody Insulators

DEALER PRICE

For latest prices, refer to DOES II.

PARTS RETENTION, RETURN, & SCRAPPING

Follow the provisions of the Warranty and Policy Manual, Section 1 - WARRANTY PARTS RETENTION AND RETURN POLICIES. If a replaced part receives a scrap disposition, the part must be scrapped in accordance with all applicable local, state and federal environmental protection and hazardous material regulations. Federal law prohibits selling motor vehicle parts or components that are under safety, compliance, or emissions recall.

EXCESS STOCK RETURN

Excess stock returned for credit must have been purchased from Ford Customer Service Division in accordance with Policy Procedure Bulletin 4000.

REPLACED FSA PARTS INSPECTION AND SIGN OFF

Effective March 1st 2021 all parts replaced as part of an FSA repair with a repair order open date of March 1st 2021 or later must be inspected and signed off on the repair order by a member of your dealers fixed operations management team or an employee the task has been delegated to. If the task is to be delegated to a non-management employee, the employee needs to be someone other than the technician who completed the repair and needs to understand the importance of completing this task consistently and accurately.

- All parts replaced as part of an FSA repair should be returned to the parts department following the Warranty Parts Retention and Return Policies.
- Inspect the replaced parts to verify the FSA repair was completed.
- If the FSA repair is found to be complete, the designated employee signs the repair order line or parts return stamp area (electronic or hand signed) for the FSA repair indicating the parts were inspected and validated to have been replaced.
- After the parts have been inspected, they should be handled based on the guidance in the parts status report in the Online Warranty System (Hold, Return, CORE, Scrap, etc.).
- This process is subject to review during warranty audits for FSA repairs with a repair order open date of March 1st 2021 or later. Any eligible FSA claims requiring parts replacement, found not to have been inspected and signed off during a warranty audit will be subject to chargeback and consideration for enrollment into the Dealer Incomplete Recall Repair Process.

Note: Other approvals (electronic or handwritten) for add-on repair lines, dealer owned vehicle repairs, and repeat repairs do not qualify as FSA parts inspection approvals. The post repair FSA parts inspection process (electronic or handwritten) is independent from other warranty approval requirements. The approval by the designated employee implies that the FSA parts were found to be replaced and must be able to be clearly identified on the Repair Order. If multiple FSA's require approval on a single Repair Order, each applicable occurrence will require individual post repair approval by the designated employee.

CERTAIN 2021-2022 MODEL YEAR F-150 VEHICLES EQUIPPED WITH A CREW CAB, 145" WHEELBASE, 4X4, ONE-PIECE ALUMINUM DRIVESHAFT, AND MFAL BHDA (LESS SOUND INSULATION PACKS) – LOOSE/SAGGING UNDERBODY INSULATORS

SERVICE PROCEDURE

GAS ENGINES – VEHICLES MANUFACTURED AT DEARBORN TRUCK ASSEMBLY PLANT

Table Of Contents

<i>Underbody Insulator Presence.....</i>	<i>1</i>
<i>Check for DTCs.....</i>	<i>3</i>
<i>Inspection.....</i>	<i>3</i>
<i>Driveshaft.....</i>	<i>3</i>
<i>Zones 1, 3 and 4.....</i>	<i>3</i>
<i>Zone 2.....</i>	<i>5</i>
<i>Driver Side Insulator.....</i>	<i>7</i>
<i>Vapor Line.....</i>	<i>7</i>
<i>Securing Underbody Insulators.....</i>	<i>9</i>
<i>Appendix A - Acceptable Photos.....</i>	<i>13</i>

Underbody Insulator Presence

1. With the vehicle in NEUTRAL, position it on a hoist. Please follow Workshop Manual (WSM) procedures in Section 100-02.
2. Are either one or both of the underbody insulators present on the vehicle? See Figure 1.

Yes – Proceed to step 3.
No – This recall is complete.



NOTE: The driver side insulator is located directly above the fuel tank.

NOTE: The passenger side insulator is located directly above the exhaust.

NOTE: Insulators are highlighted for illustration purposes only.

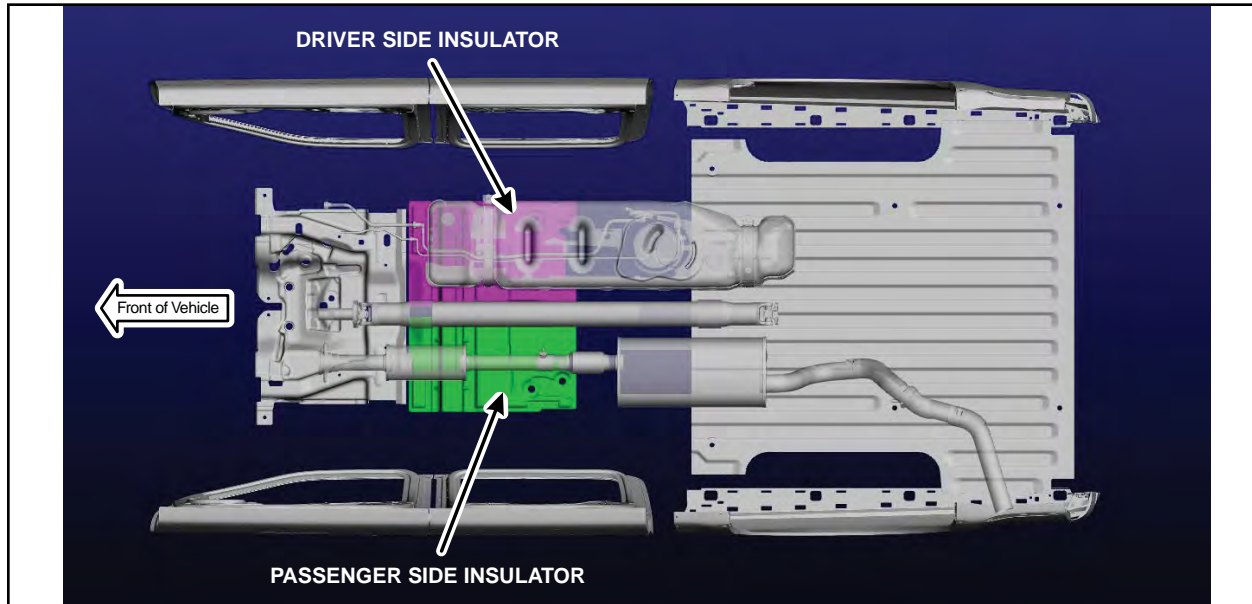

FIGURE 1

Review the video link below before starting this repair procedure:

 <https://bcove.video/3rdmqR0>

Materials List

Ruler/Scale/ Straight Edge	13 mm (1/2 in) Drill Stop	Small Brush
Drill	6.7 mm (17/64 in) Drill Bit	Marker
1/4" Rivet Gun	5.1 mm (13/64 in) Drill Bit – Rivet W719880-S417	Tape

NOTE: A 1/4" air over hydraulic rivet gun was used for the service trials for this program, however a pneumatic rivet gun or a manual rivet gun may also be used. However, it may not be possible to access and properly secure the rivets into the floor pan using a manual rivet gun. It is important to always confirm the rivet is properly secured to the floor pan of the vehicle.



Check for DTCs

- Using the Ford Diagnostic and Repair System (FDRS), check the Powertrain Control Module (PCM) for DTCs. Are either of the following DTC's present in the PCM, P0442 and/or P0456?

Yes - Please follow Workshop Manual (WSM) procedures for pinpoint test HX in Section 303-13, then proceed to step 4.
No - Proceed to step 4.

Inspection

- Remove the driveshaft. Please follow WSM procedures in Section 205-01.

NOTE: Do NOT discard the driveshaft flange to pinion flange bolts.

Zones 1, 3 and 4

- Inspect Zones 1, 3 and 4 of the rear driveshaft for any marks caused by the front and/or rear edges of the passenger side insulator. Are there any marks present in Zones 1, 3 or 4? See Figure 2.

Yes – Proceed to step 6.
No – Proceed to step 8.

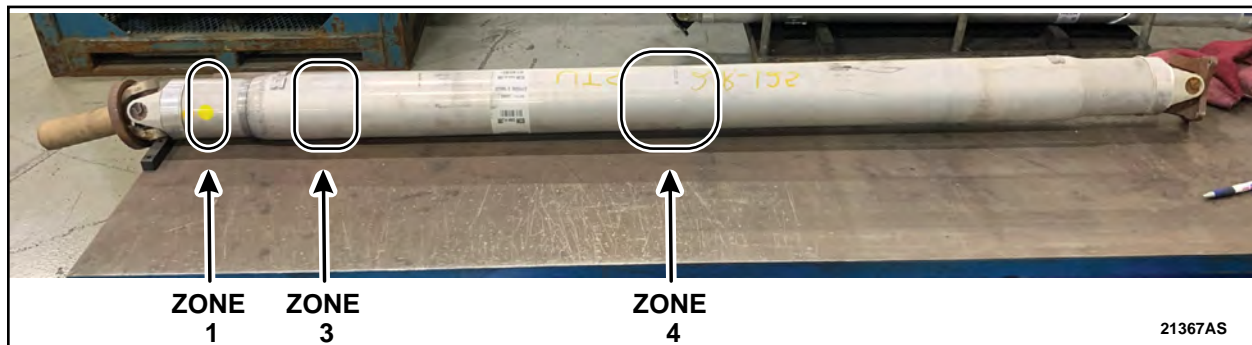

FIGURE 2

- What is the current odometer reading?

> 2,500 miles – Proceed to step 7.
< 2,500 miles – Proceed to step 8.



7. Place a straight edge along the driveshaft over the wear mark and attempt to fit a 0.018in (0.45mm) feeler gauge between the flat edge and the wear mark. Can the feeler gauge fit between the straight edge and anywhere along the wear mark? See Figures 3 and 4.

Yes – Does not pass inspection. Contact the SSSC and provide a picture of the driveshaft with the feeler gauge fitting between the straight edge and wear mark. Once approved, rear driveshaft replacement will be required, but do not install at this time. Proceed to step 10.

No – Passes inspection. Proceed to step 8.

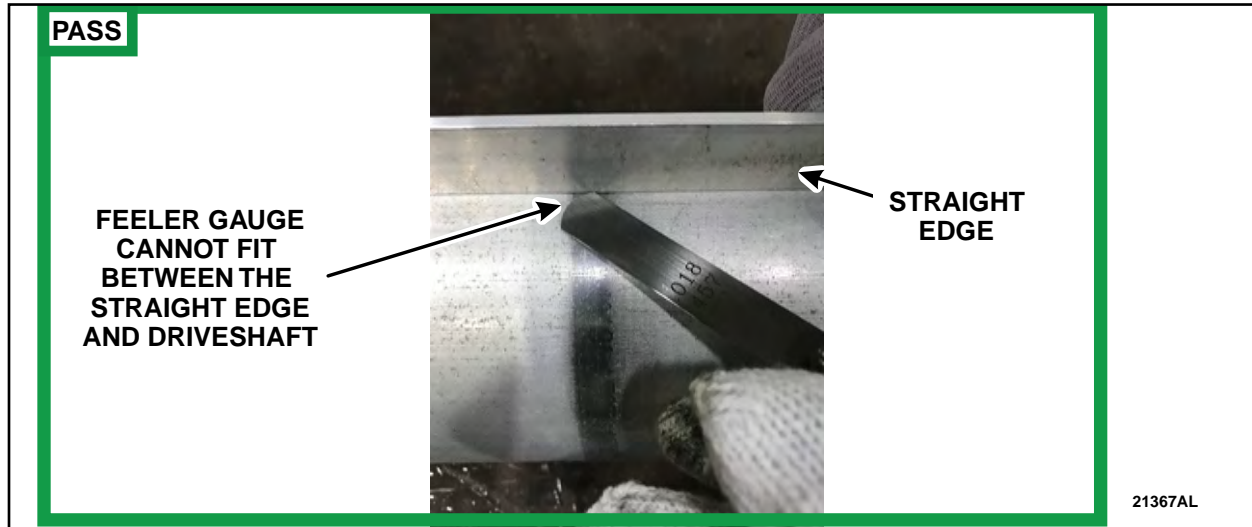

FIGURE 3

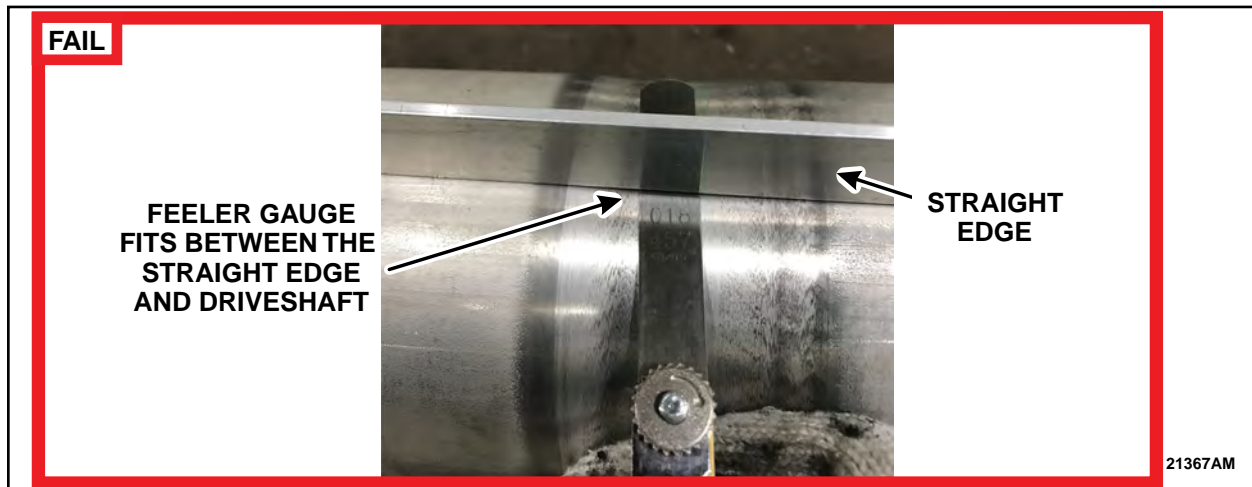

FIGURE 4



Zone 2

8. Inspect Zone 2 (transition from larger tube diameter to smaller diameter section) of the driveshaft tube for any marks caused by the front edge of the passenger side insulator. Are there any marks present? See Figure 5.

Yes – Does not pass inspection. Proceed to step 9.

No – Passes inspection. Driveshaft may be reused. Proceed to step 10.



FIGURE 5

9. Inspect the marks found on Zone 2. Is the aluminum tube surface grain pattern worn off, completely smooth, or have an appearance of necking? See Figures 6 through 9.

Yes – Does not pass inspection. Contact the SSSC and provide a picture of the driveshaft with the grain pattern worn off. Be sure to show a clear image of the grain pattern missing. Once approved, rear driveshaft replacement will be required, but do not install at this time. Proceed to step 10.

No – Passes inspection. Driveshaft may be reused. Proceed to step 10.

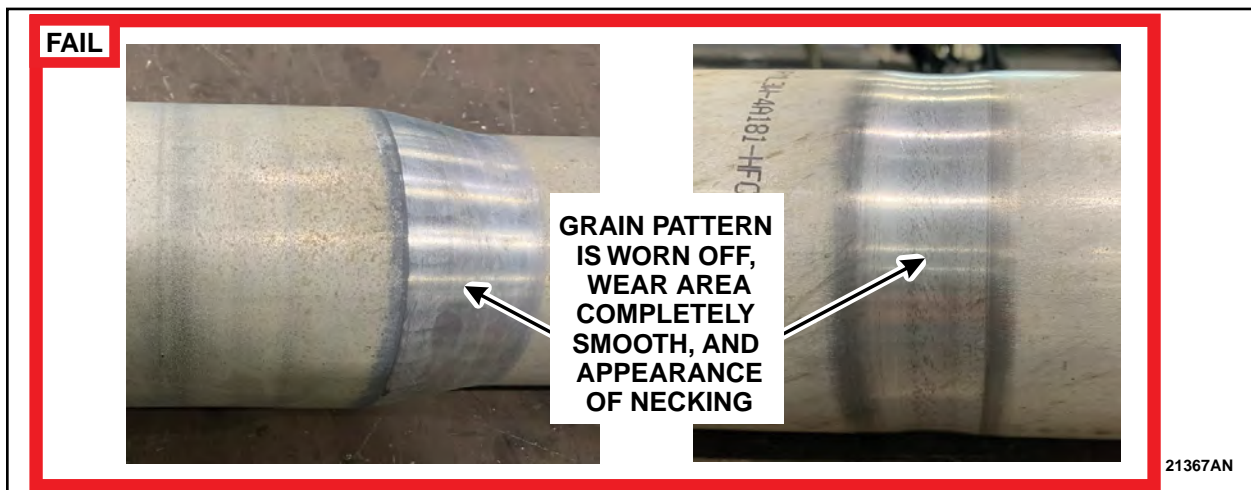

FIGURE 6



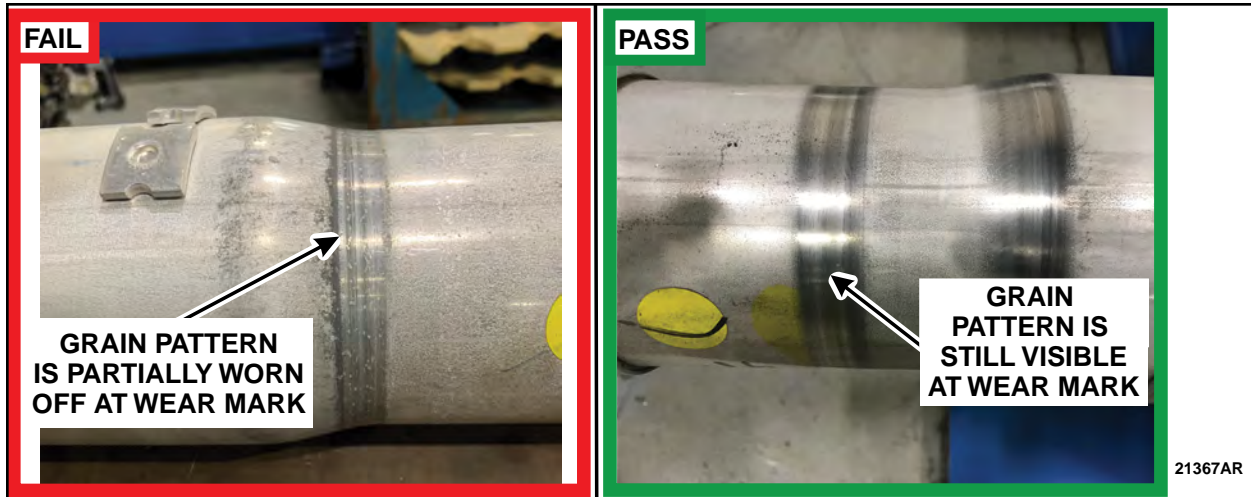

FIGURE 7

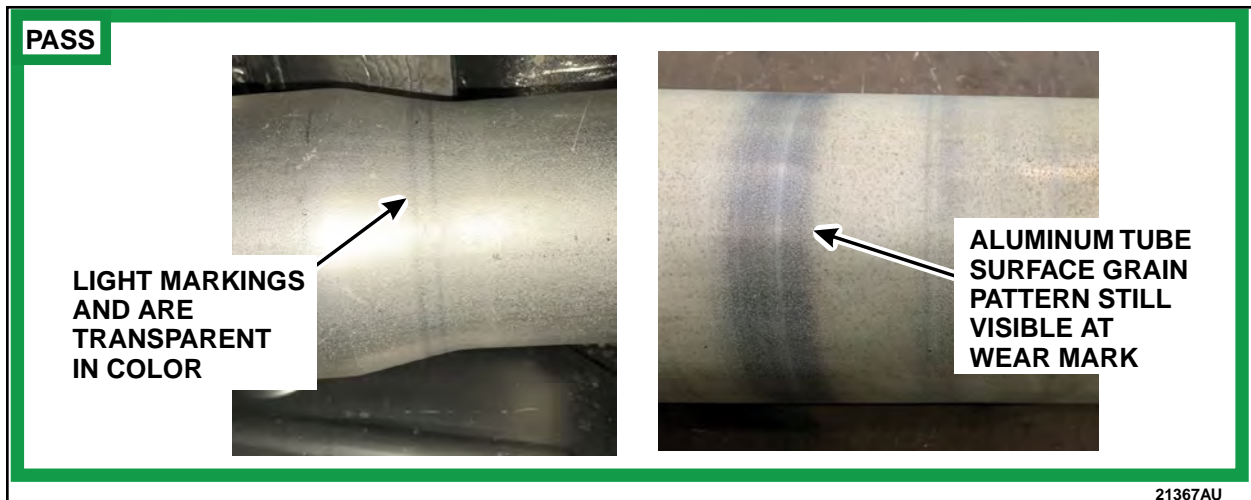

FIGURE 8



FIGURE 9



Driver Side Insulator

10. Inspect the driver side insulator for any edges hanging down or touching the fuel tank. Is the insulator hanging down or touching the fuel tank? See Figure 10.

Yes – Does not pass inspection. Proceed to step 11.

No – Passes inspection. Proceed to step 13.

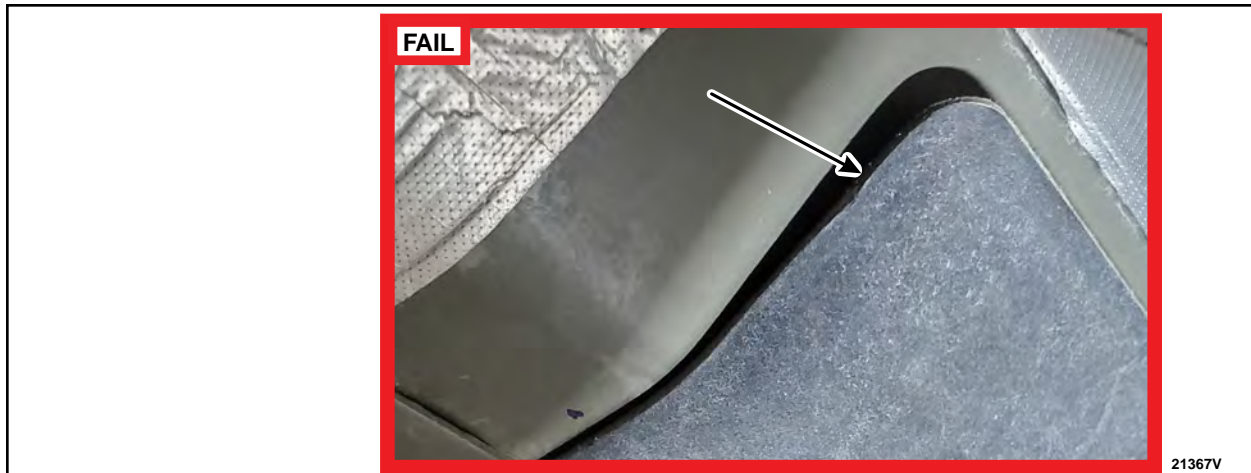

FIGURE 10

11. Remove the fuel tank to gain access to the vapor line. Please follow WSM procedures in Section 310-01.

12. Inspect the vapor line for any damage caused by the driver side insulator. Is there any damage to the line? See Figures 11 through 13.

Yes – Does not pass inspection. Replace the damaged line. Please follow WSM procedures in Section 310-01, then proceed to step 13.

No – Passes inspection. Proceed to step 13.

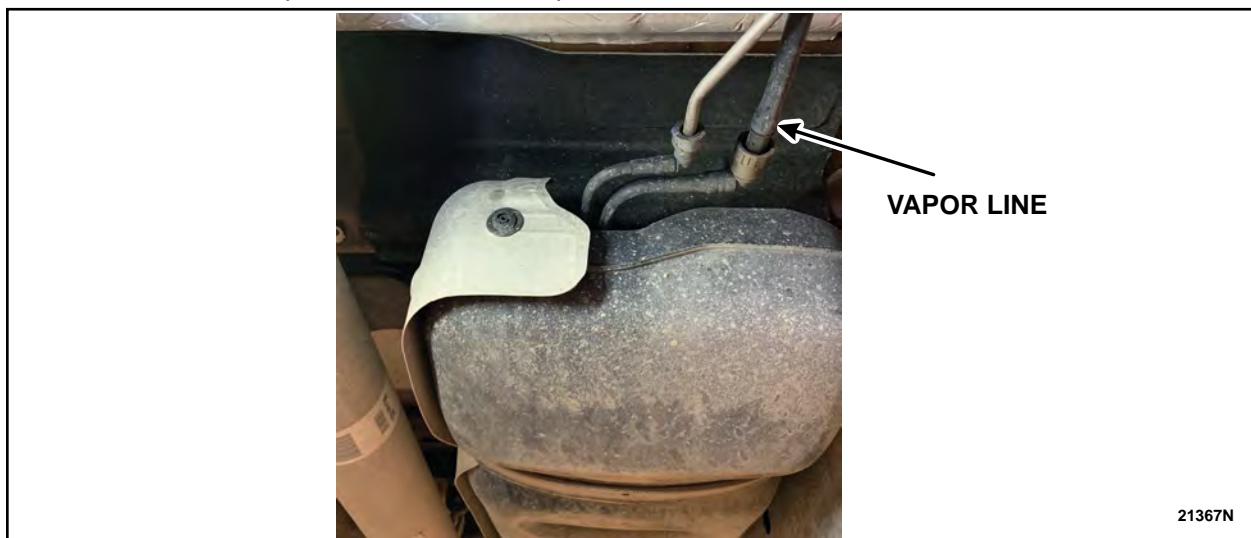

FIGURE 11



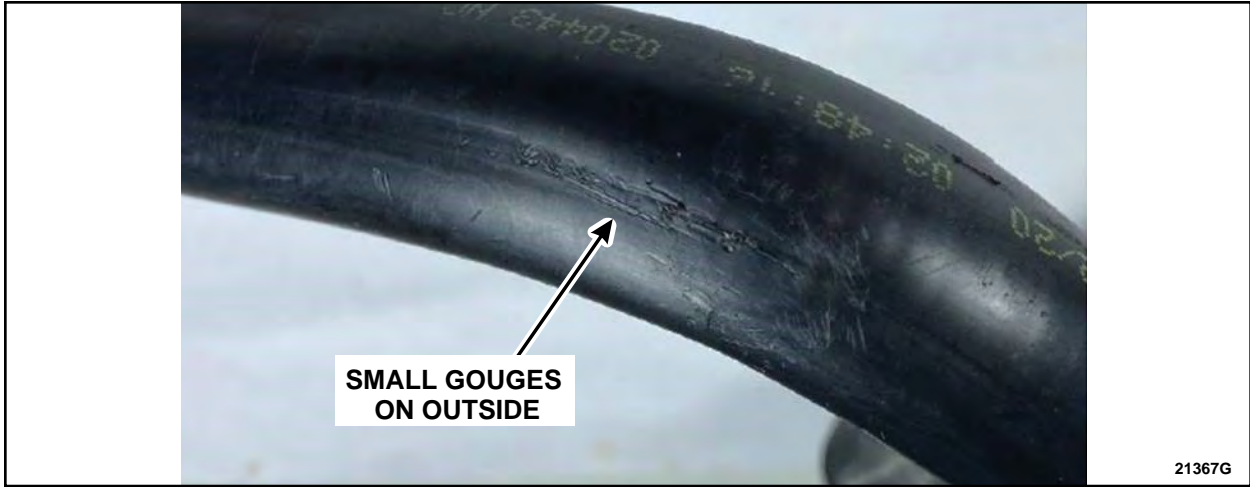

FIGURE 12

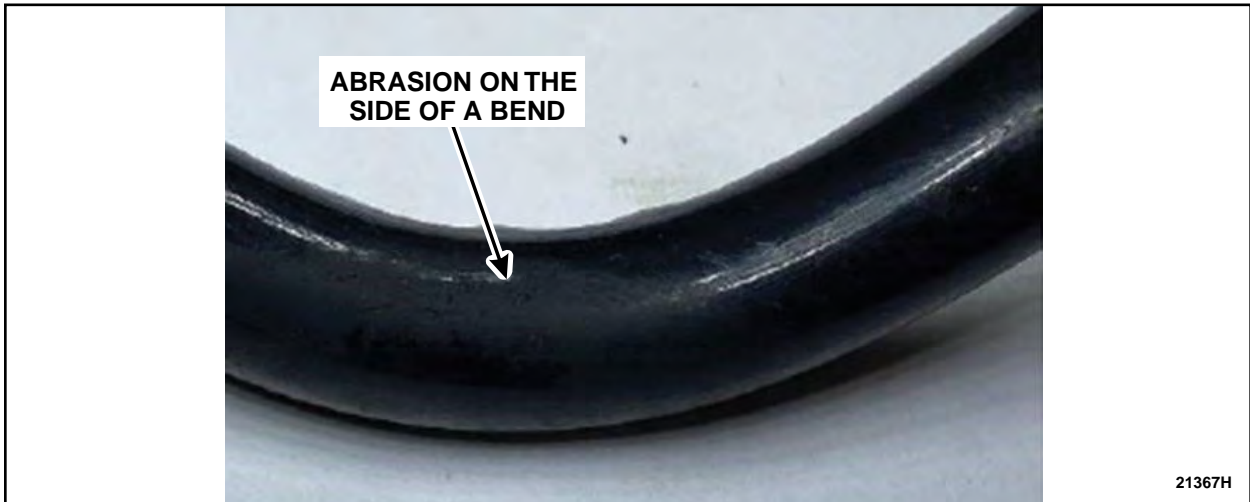

FIGURE 13



Securing Underbody Insulators

NOTE: Perform steps 13 through 22 ONLY on the side(s) where the insulator(s) are present.

13. Measure and mark the four locations on the passenger side insulator and mark the one location on the driver side insulator. See Figures 14 and 15.

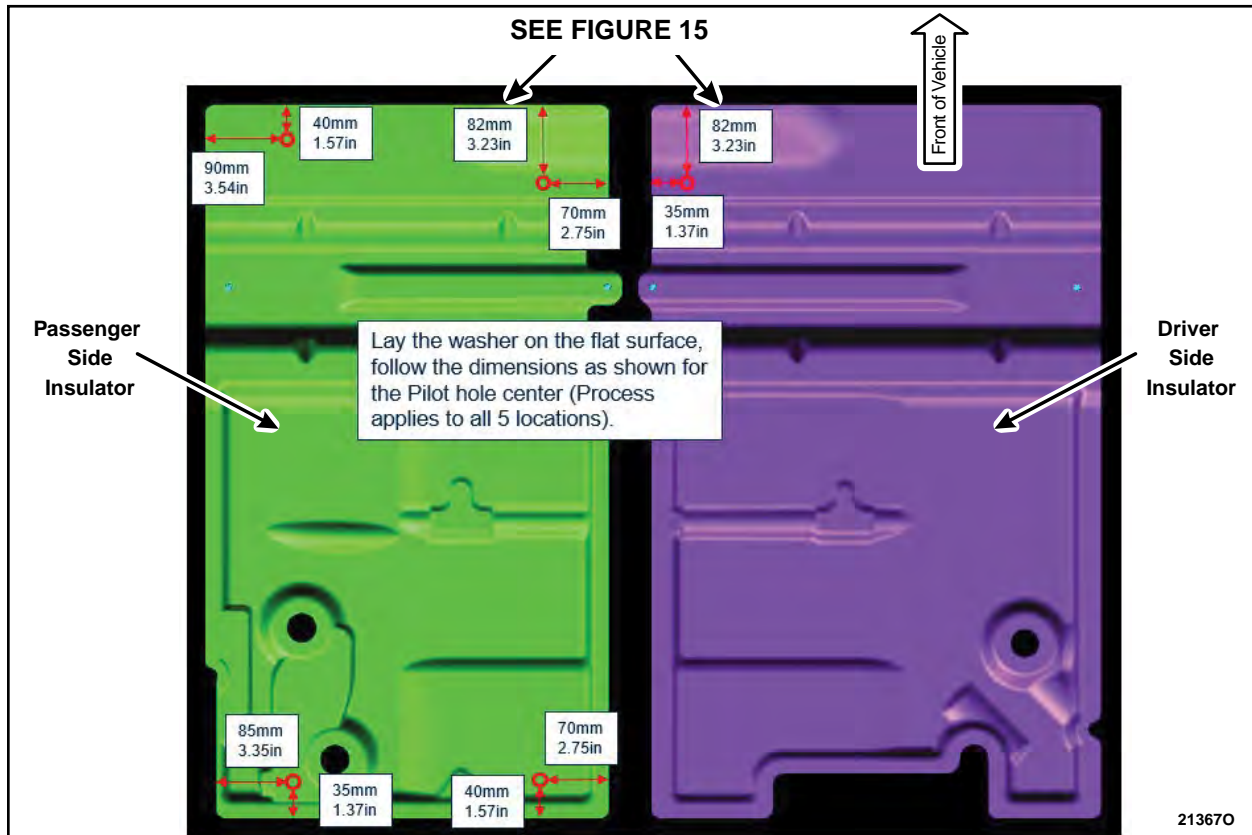

FIGURE 14

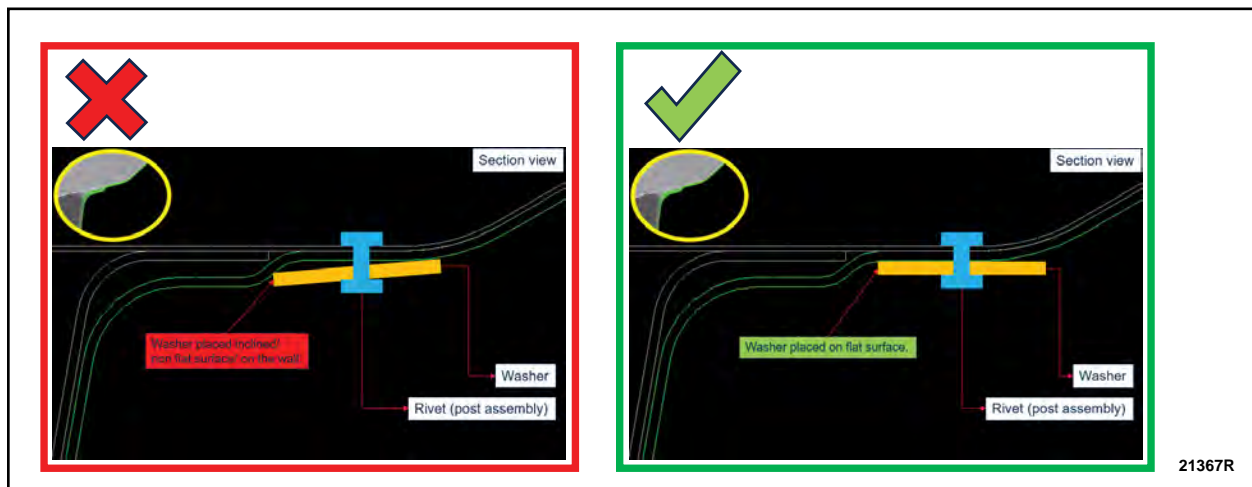

FIGURE 15



14. Use the 5.1 mm (13/64 in) drill bit for rivet part number W719880-S417 or the 6.7mm (17/64 in) drill bit for all other rivet part numbers to drill a hole through the insulator and into the floor. See Figure 16.

NOTE: Use the 13 mm (1/2 in) drill stop to ensure you do not drill through the carpet.



FIGURE 16

15. Repeat step 14 for the remaining four marked locations.
16. Using a small brush, apply a layer of the anti-corrosion coating to the edges of the newly drilled holes.
17. Install the washer onto the rivet. See Figure 17.

NOTE: All approved listed rivet part numbers may not look identical to the photos in the technical instructions.



FIGURE 17



18. Apply a thick layer of seam sealer to the rivet, and the backside of the washer. See Figure 18.



FIGURE 18

19. Using a 1/4" rivet gun, install the rivet and washer to the drilled hole. See Figure 19.

NOTE: To ensure the rivet is properly secured, apply as much force to the rivet gun as possible.

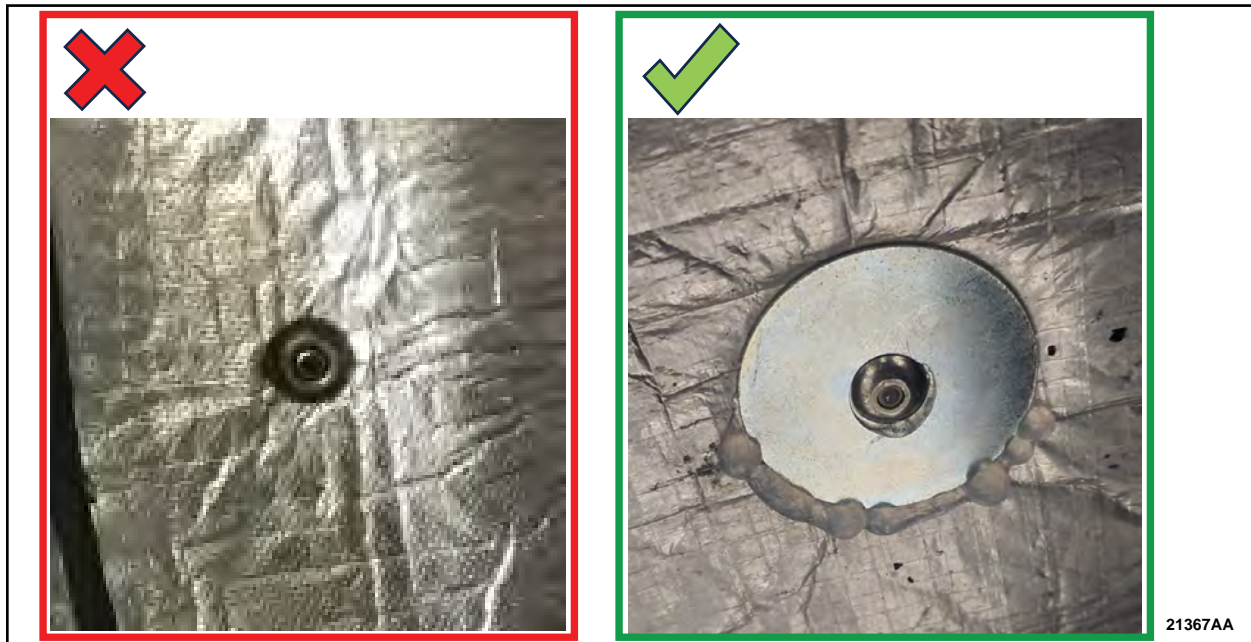

FIGURE 19

20. Attempt to move the washer/rivet to confirm it is properly secured.

21. Using a small brush, apply a layer of the anti-corrosion coating to the washer and rivet.

22. Repeat steps 17-21 for the remaining four drilled holes.



23. Install the fuel tank if it was removed in the inspection. Please follow WSM procedures in Section 310-01.

24. Using an air blow gun, remove any debris from threaded holes in axle flange. See Figure 20.

NOTE: Make sure that the mating faces are clean and free of foreign material.

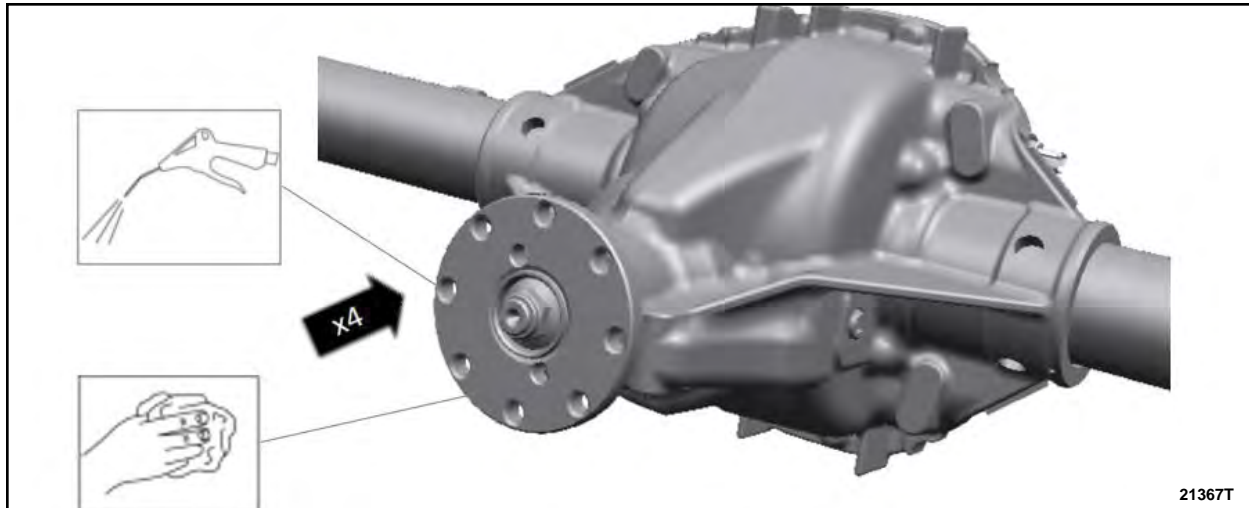

FIGURE 20

25. Inspect the original driveshaft flange to pinion flange bolts for rust in the threads and replace if rusted or damaged. Clean threads of the original driveshaft flange to pinion flange bolts with a wire brush and coat the threads with LOCTITE 243 Blue Medium Strength Threadlocker or equivalent. See Figure 21.

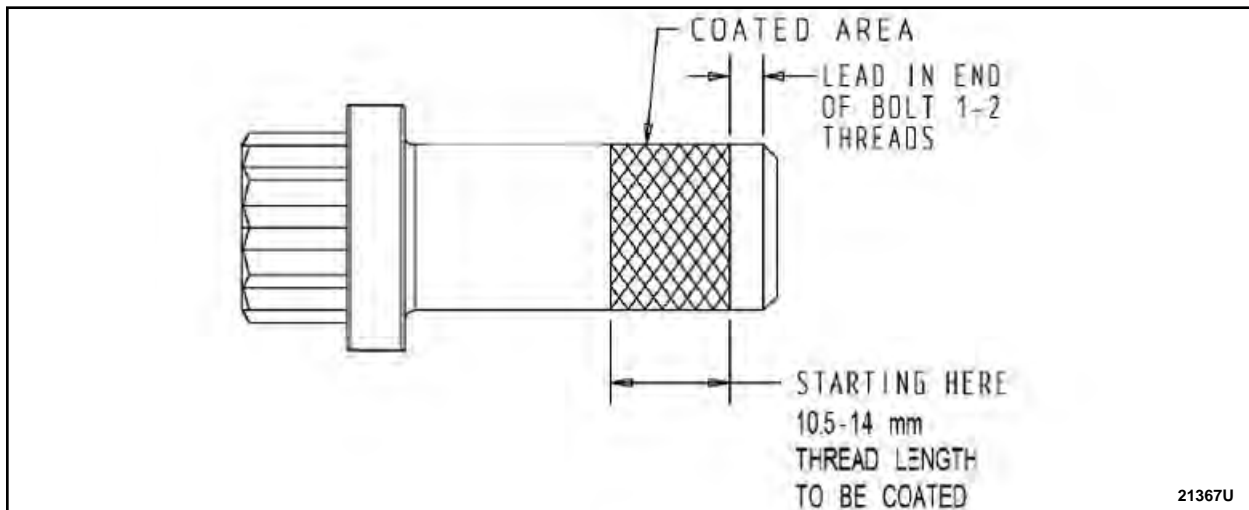

FIGURE 21

26. Install the driveshaft. Please follow WSM procedures in Section 205-01.



Appendix A – Acceptable Photos



FIGURE 22

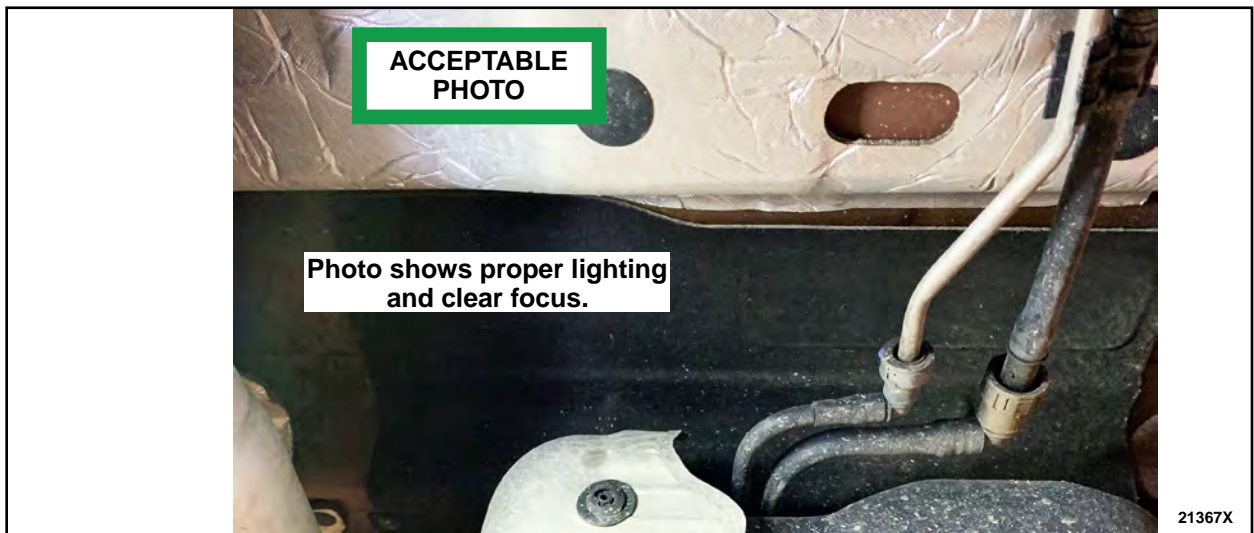

FIGURE 23



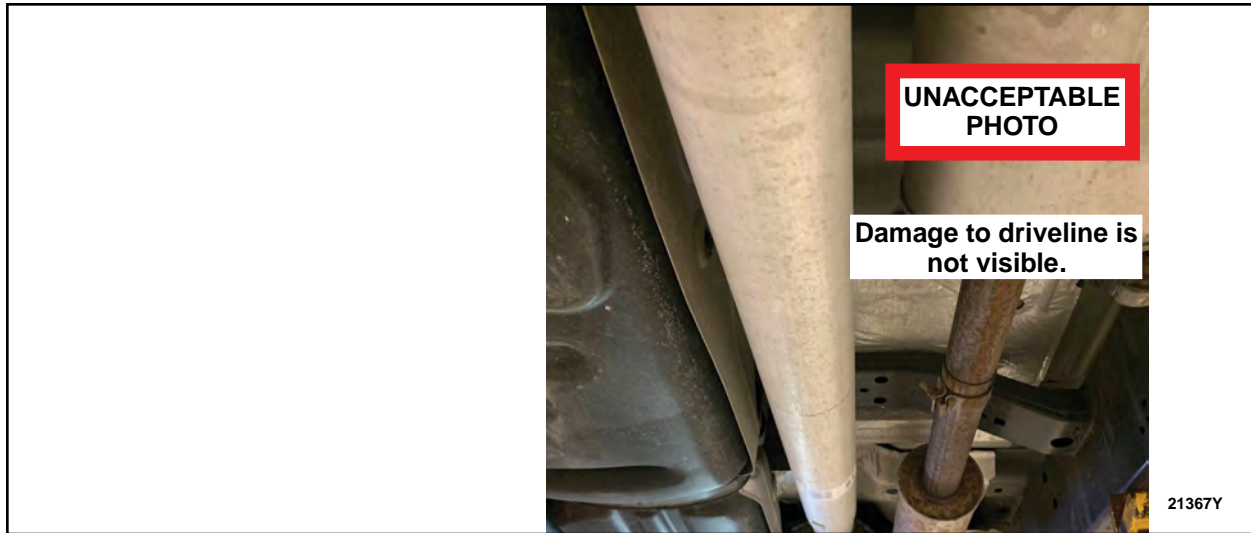

FIGURE 24



FIGURE 25



CERTAIN 2021-2022 MODEL YEAR F-150 VEHICLES EQUIPPED WITH A CREW CAB, 145" WHEELBASE, 4X4, ONE-PIECE ALUMINUM DRIVESHAFT, AND MFAL BHDA (LESS SOUND INSULATION PACKS) – LOOSE/SAGGING UNDERBODY INSULATORS

SERVICE PROCEDURE

DIESEL ENGINES

Table Of Contents

Underbody Insulator Presence.....1
Inspection.....3
Driveshaft.....3
Zones 1, 3 and 4.....3
Zone 2.....5
Securing Underbody Insulators.....7
Appendix A - Acceptable Photos.....11

Underbody Insulator Presence

1. With the vehicle in NEUTRAL, position it on a hoist. Please follow Workshop Manual (WSM) procedures in Section 100-02.
2. Are either one or both of the underbody insulators present on the vehicle? See Figure 1.

Yes – Proceed to step 3.
No – This recall is complete.



NOTE: The driver side insulator is located directly above the fuel tank.

NOTE: The passenger side insulator is located directly above the exhaust.

NOTE: Insulators are highlighted for illustration purposes only.

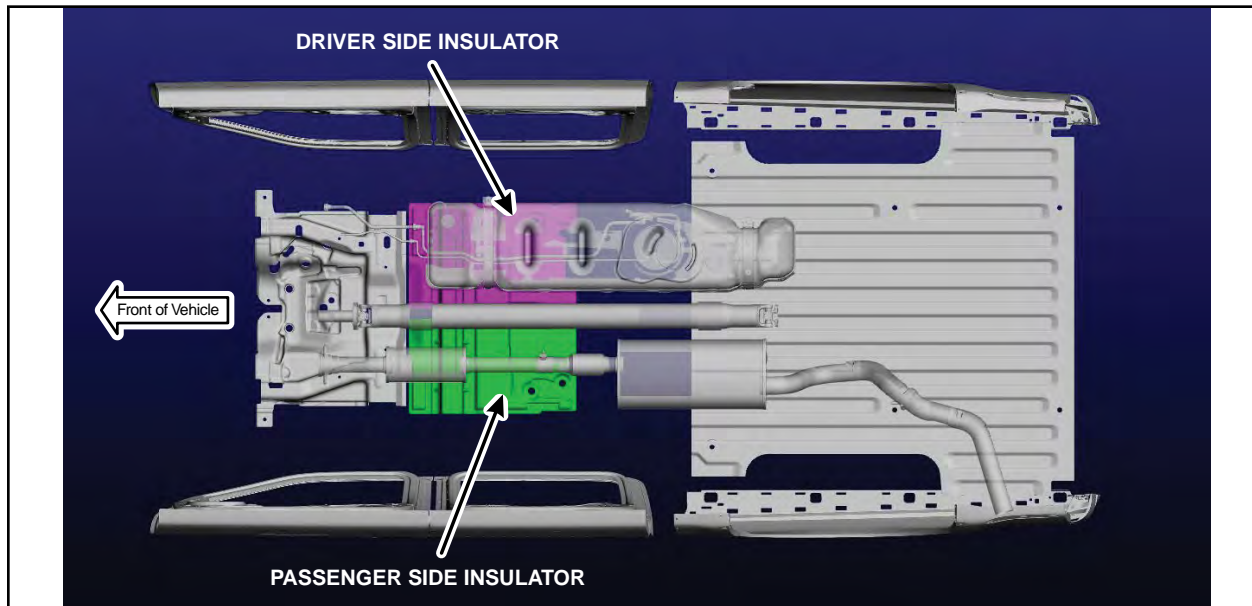

FIGURE 1

Review the video link below before starting this repair procedure:

 <https://bcove.video/3rdmqR0>

Materials List

Ruler/Scale/ Straight Edge	13 mm (1/2 in) Drill Stop	Small Brush
Drill	6.7 mm (17/64 in) Drill Bit	Marker
1/4" Rivet Gun	5.1 mm (13/64 in) Drill Bit – Rivet W719880-S417	Tape

NOTE: A 1/4" air over hydraulic rivet gun was used for the service trials for this program, however a pneumatic rivet gun or a manual rivet gun may also be used. However, it may not be possible to access and properly secure the rivets into the floor pan using a manual rivet gun. It is important to always confirm the rivet is properly secured to the floor pan of the vehicle.



Inspection

3. Remove the driveshaft. Please follow WSM procedures in Section 205-01.

NOTE: Do NOT discard the driveshaft flange to pinion flange bolts.

Zones 1, 3 and 4

4. Inspect Zones 1, 3 and 4 of the rear driveshaft for any marks caused by the front and/or rear edges of the passenger side insulator. Are there any marks present in Zones 1, 3 or 4?
See Figure 2.

Yes – Proceed to step 5.

No – Proceed to step 7.

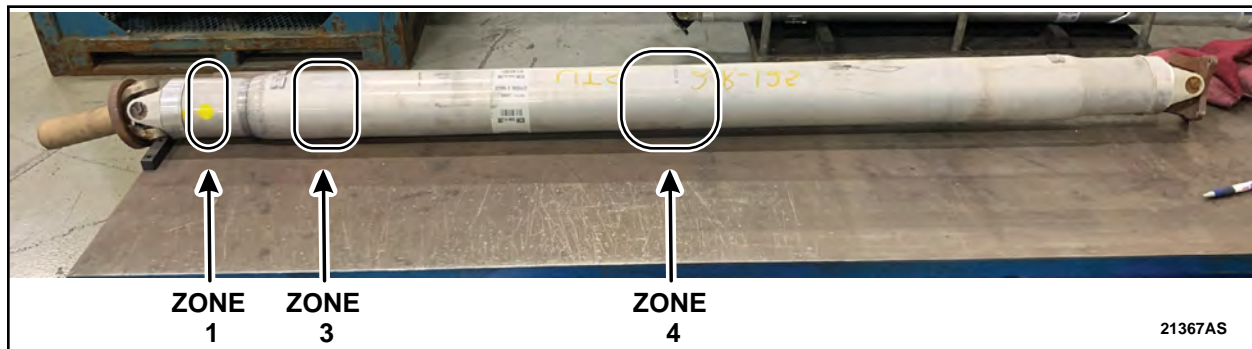

FIGURE 2

5. What is the current odometer reading?

> 2,500 miles – Proceed to step 6.

< 2,500 miles – Proceed to step 7.



6. Place a straight edge along the driveshaft over the wear mark and attempt to fit a 0.018in (0.45mm) feeler gauge between the flat edge and the wear mark. Can the feeler gauge fit between the straight edge and anywhere along the wear mark? See Figures 3 and 4.

Yes – Does not pass inspection. Contact the SSSC and provide a picture of the driveshaft with the feeler gauge fitting between the straight edge and wear mark. Once approved, rear driveshaft replacement will be required, but do not install at this time. Proceed to step 9.

No – Passes inspection. Proceed to step 7.

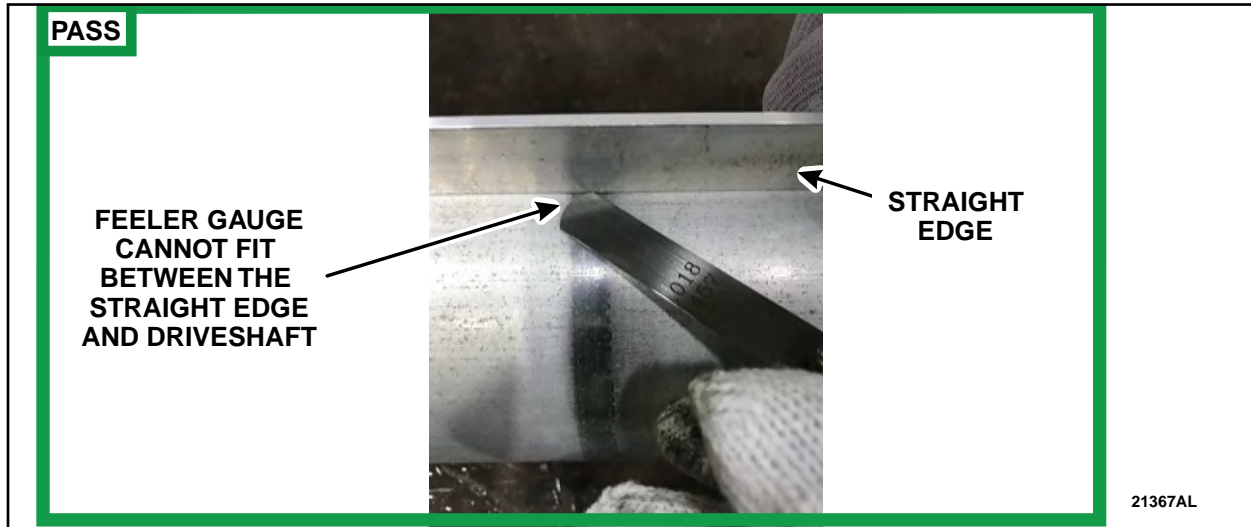

FIGURE 3

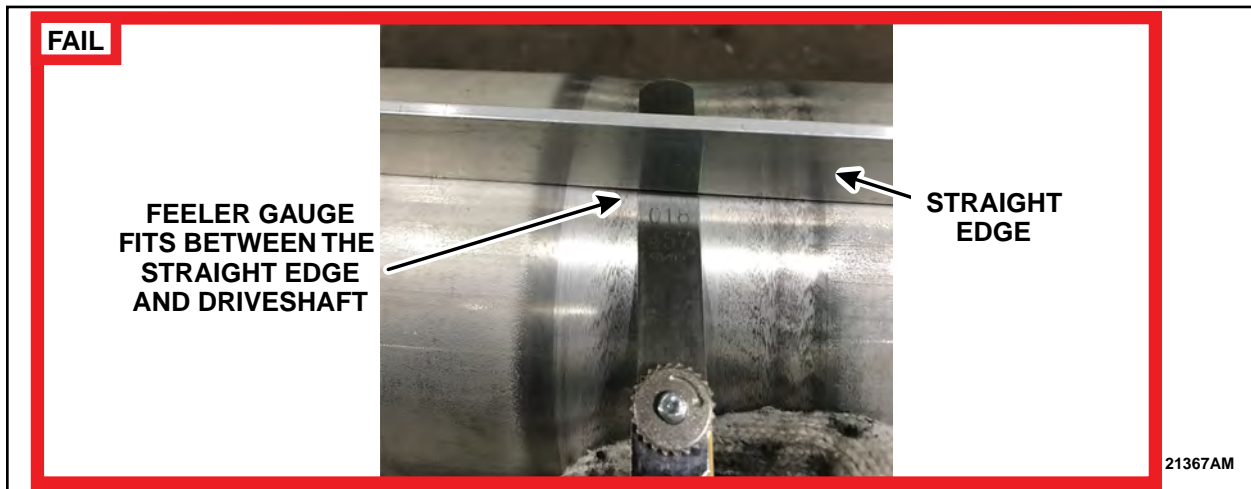

FIGURE 4



Zone 2

7. Inspect Zone 2 (transition from larger tube diameter to smaller diameter section) of the driveshaft tube for any marks caused by the front edge of the passenger side insulator. Are there any marks present? See Figure 5.

Yes – Does not pass inspection. Proceed to step 8.

No – Passes inspection. Driveshaft may be reused. Proceed to step 9.



FIGURE 5

8. Inspect the marks found on Zone 2. Is the aluminum tube surface grain pattern worn off, completely smooth, or have an appearance of necking? See Figures 6 through 9.

Yes – Does not pass inspection. Contact the SSSC and provide a picture of the driveshaft with the grain pattern worn off. Be sure to show a clear image of the grain pattern missing. Once approved, rear driveshaft replacement will be required, but do not install at this time. Proceed to step 9.

No – Passes inspection. Driveshaft may be reused. Proceed to step 9.

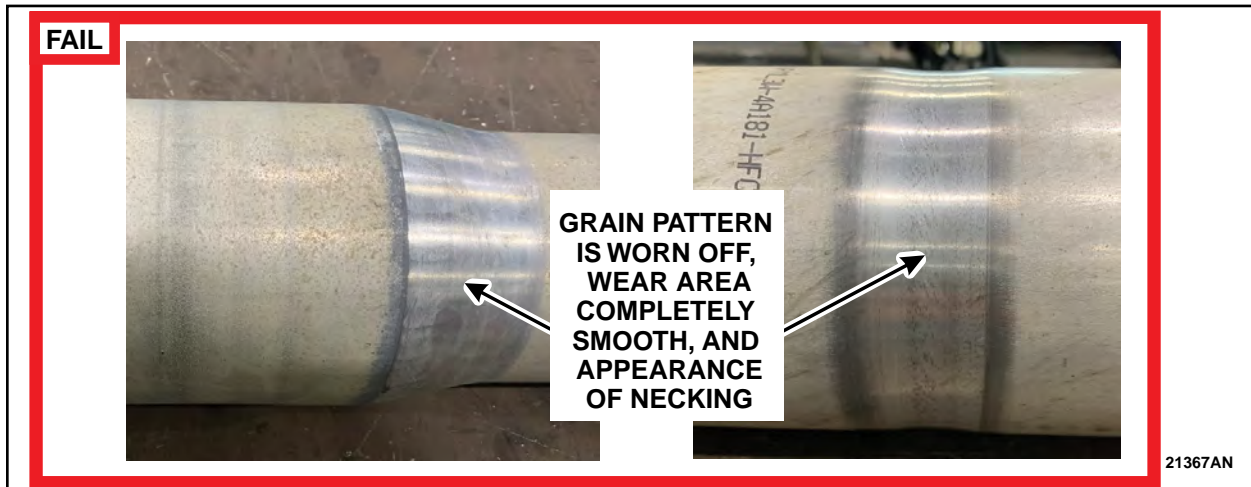

FIGURE 6



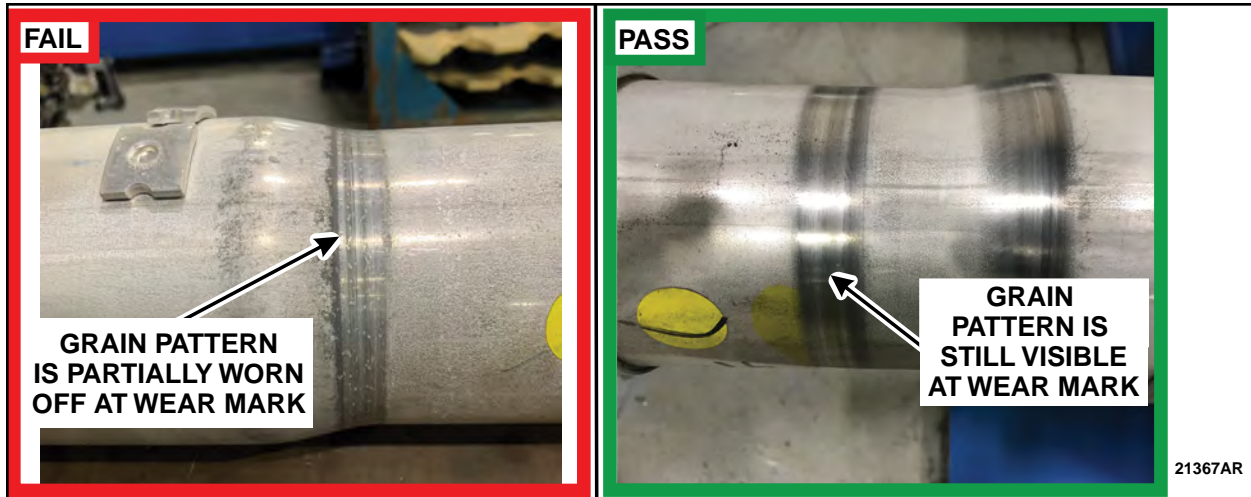

FIGURE 7

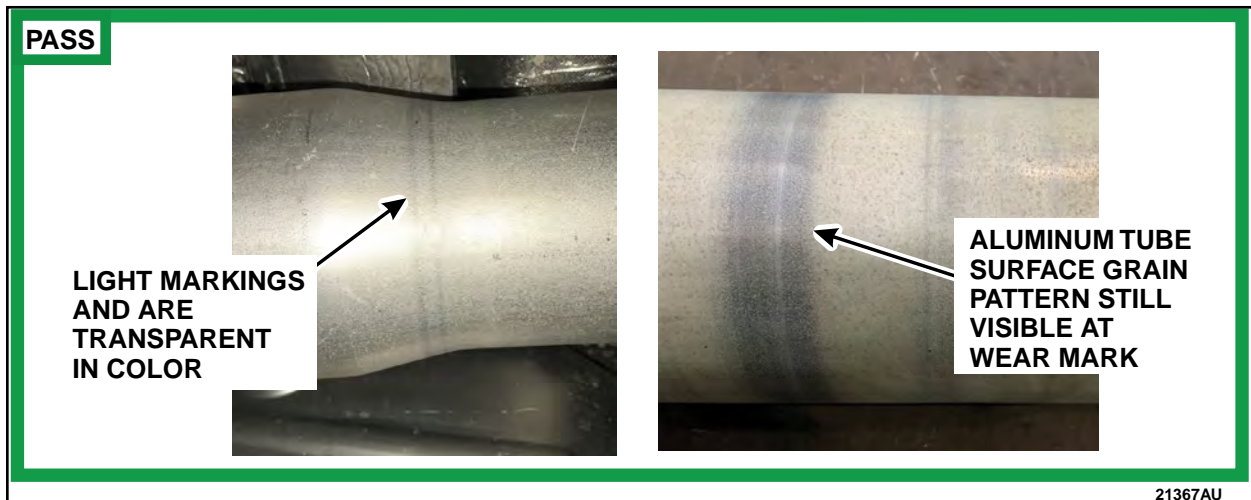

FIGURE 8



FIGURE 9



Securing Underbody Insulators

NOTE: Perform steps 9 through 18 ONLY on the side(s) where the insulator(s) are present.

- Measure and mark the four locations on the passenger side insulator and mark the one location on the driver side insulator. See Figures 10 and 11.

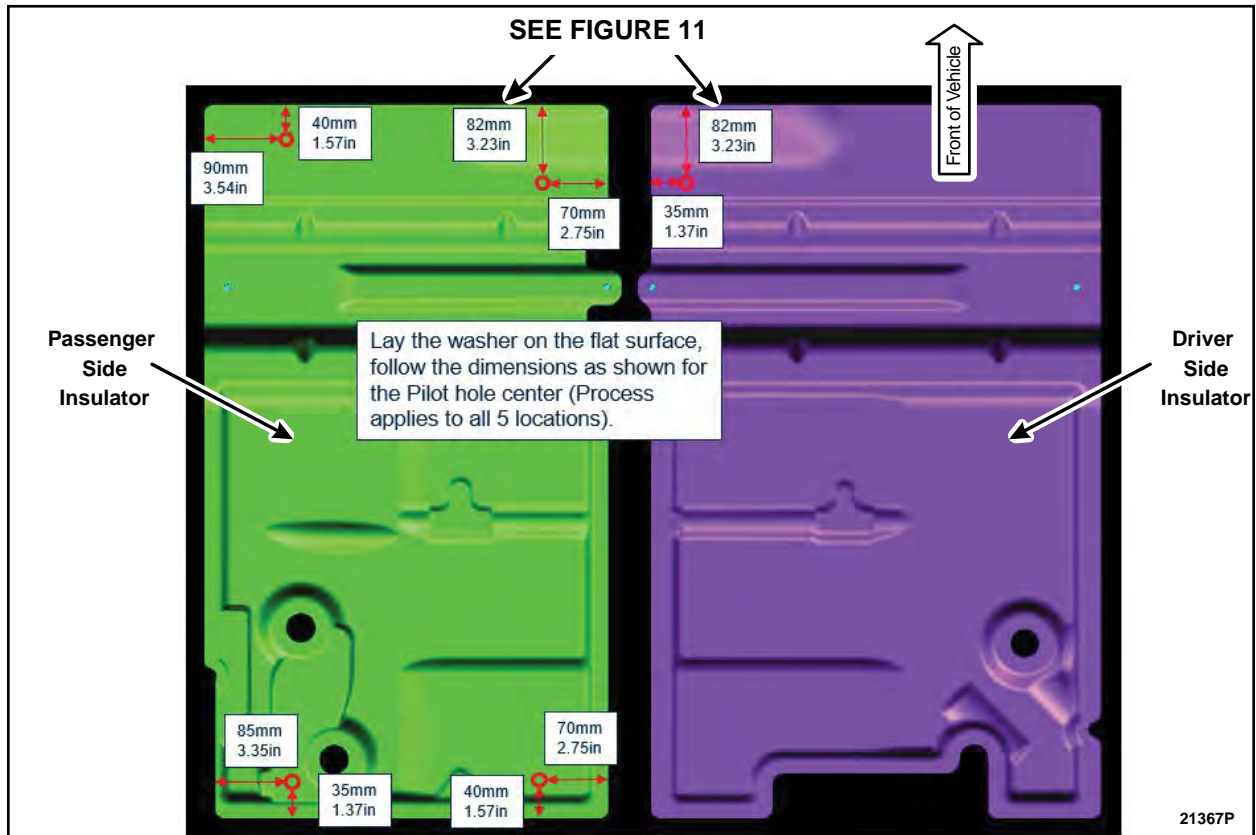

FIGURE 10

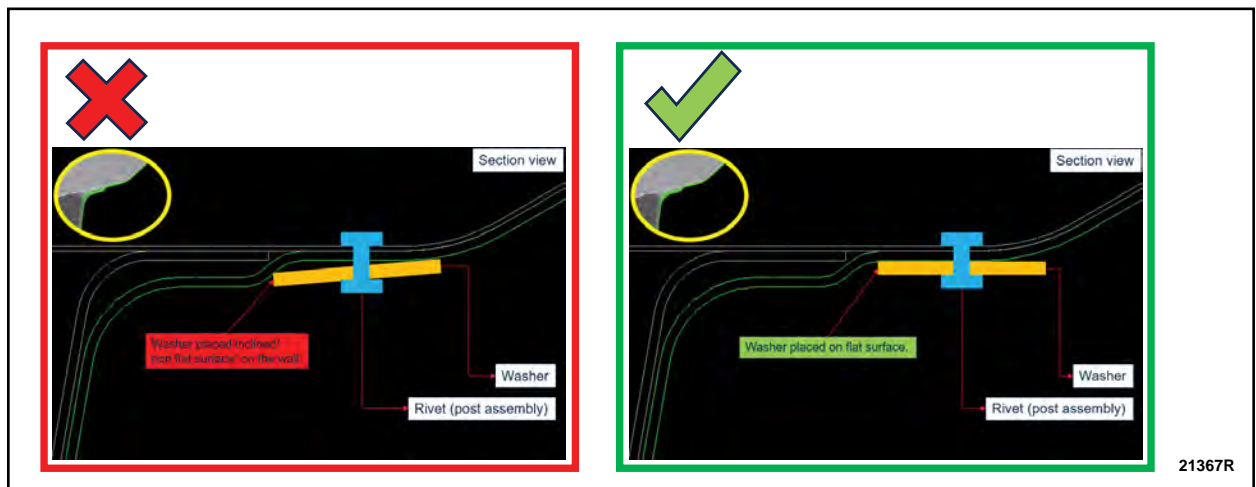

FIGURE 11



10. Use the 5.1 mm (13/64 in) drill bit for rivet part number W719880-S417 or the 6.7mm (17/64 in) drill bit for all other rivet part numbers to drill a hole through the insulator and into the floor. See Figure 12.

NOTE: Use the 13 mm (1/2 in) drill stop to ensure you do not drill through the carpet.



FIGURE 12

11. Repeat step 10 for the remaining four marked locations.
12. Using a small brush, apply a layer of the anti-corrosion coating to the edges of the newly drilled holes.
13. Install the washer onto the rivet. See Figure 13.

NOTE: All approved listed rivet part numbers may not look identical to the photos in the technical instructions.



FIGURE 13



14. Apply a thick layer of seam sealer to the rivet, and the backside of the washer. See Figure 14.



FIGURE 14

15. Using a 1/4" rivet gun, install the rivet and washer to the drilled hole. See Figure 15.

NOTE: To ensure the rivet is properly secured, apply as much force to the rivet gun as possible.

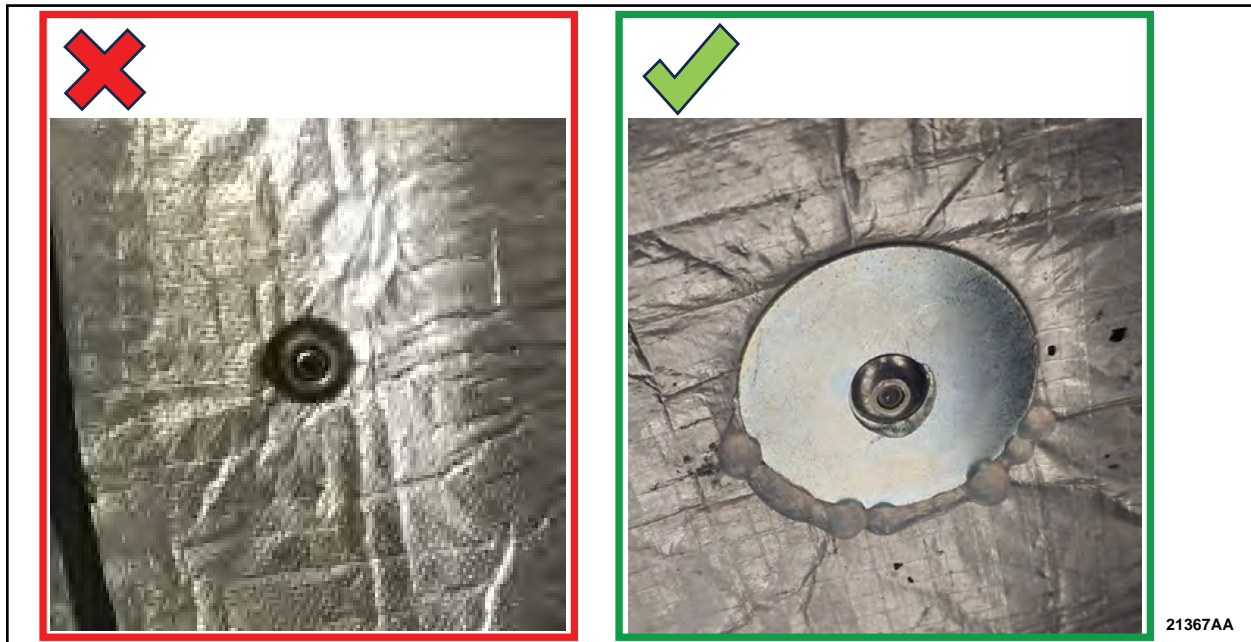

FIGURE 15

16. Attempt to move the washer/rivet to confirm it is properly secured.

17. Using a small brush, apply a layer of the anti-corrosion coating to the washer and rivet.

18. Repeat steps 13-17 for the remaining four drilled holes.



19. Using an air blow gun, remove any debris from threaded holes in axle flange. See Figure 16.

NOTE: Make sure that the mating faces are clean and free of foreign material.

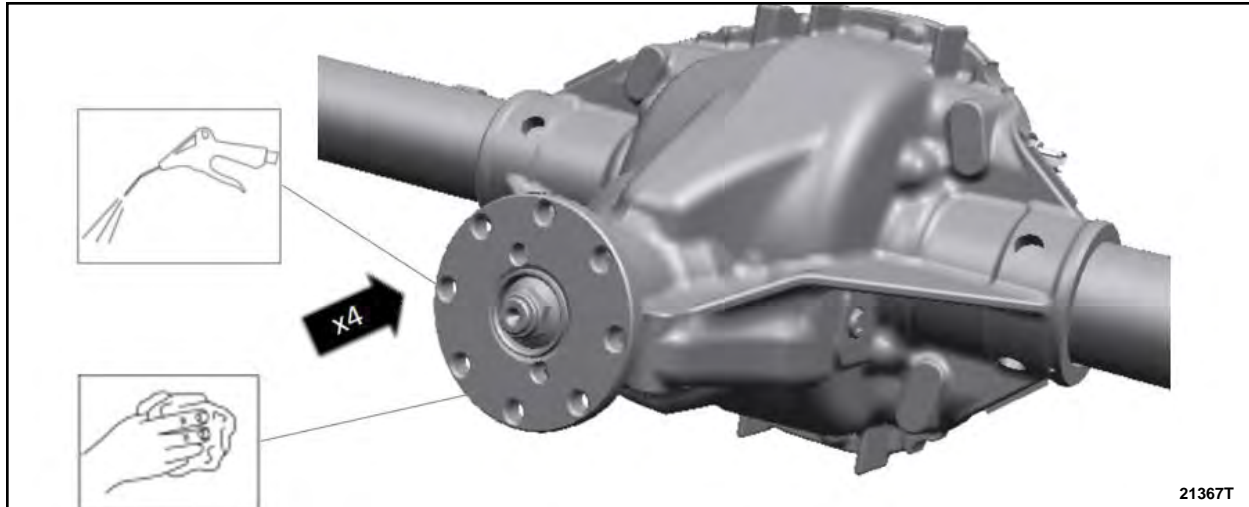

FIGURE 16

20. Inspect the original driveshaft flange to pinion flange bolts for rust in the threads and replace if rusted or damaged. Clean threads of the original driveshaft flange to pinion flange bolts with a wire brush and coat the threads with LOCTITE 243 Blue Medium Strength Threadlocker or equivalent. See Figure 17.

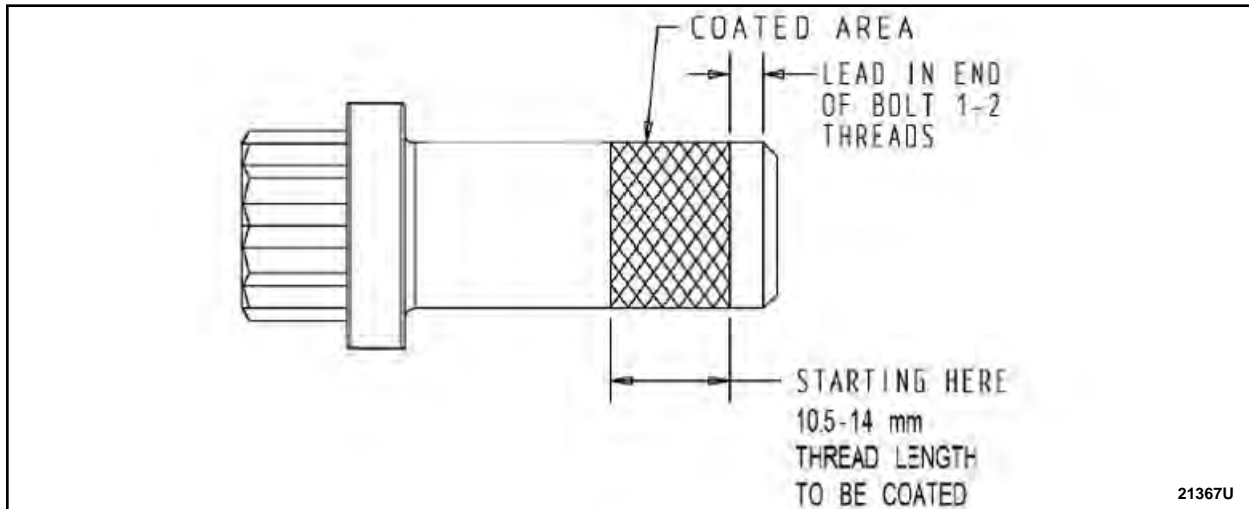

FIGURE 17

21. Install the driveshaft. Please follow WSM procedures in Section 205-01.



Appendix A – Acceptable Photos



FIGURE 18

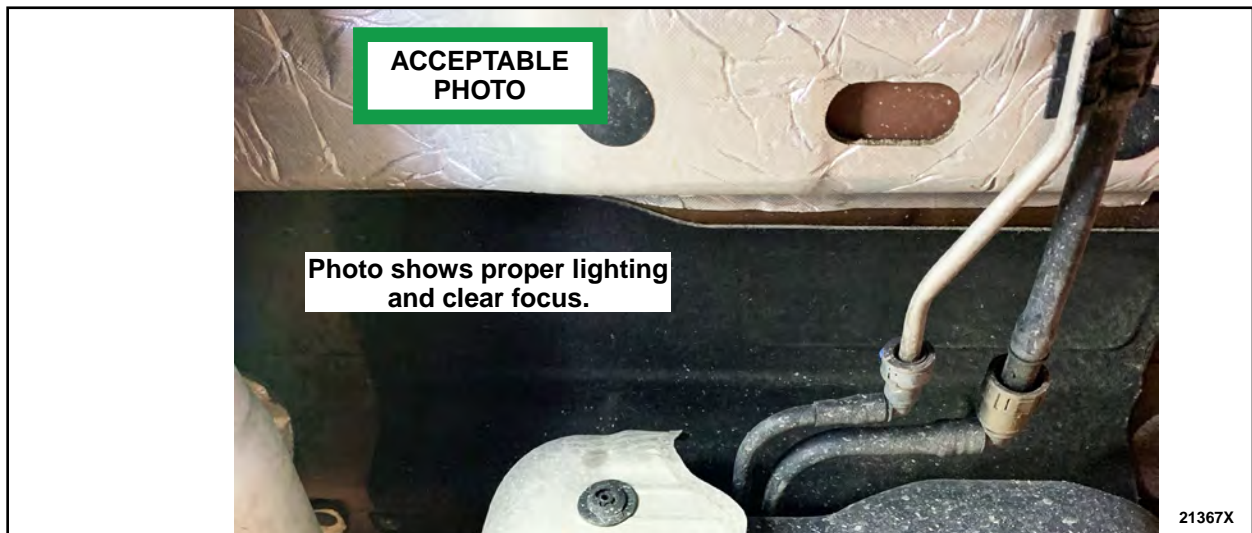

FIGURE 19



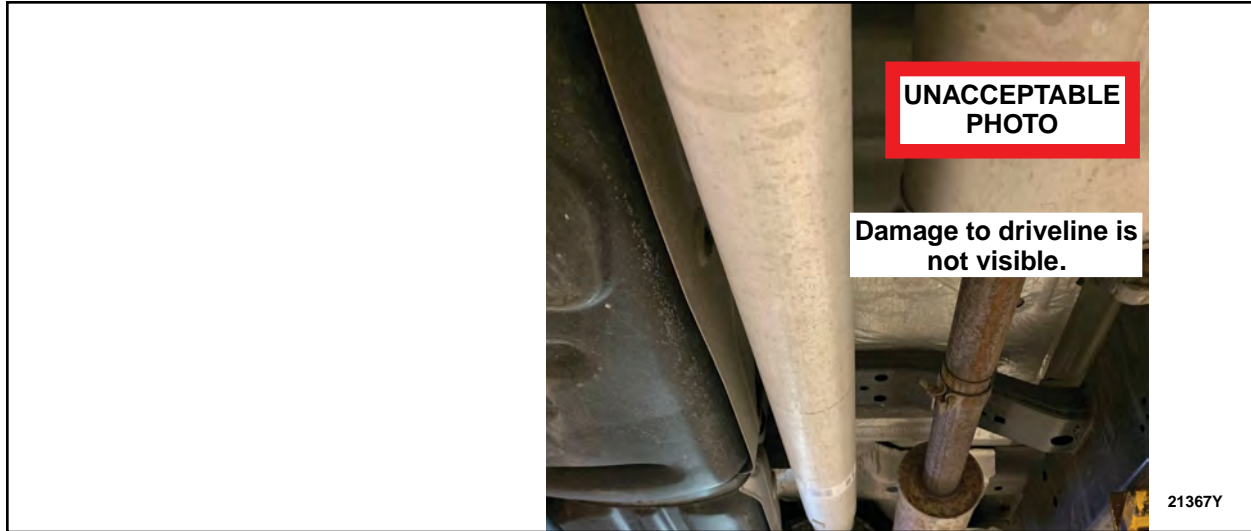

FIGURE 20



FIGURE 21



CERTAIN 2021-2022 MODEL YEAR F-150 VEHICLES EQUIPPED WITH A CREW CAB, 145" WHEELBASE, 4X4, ONE-PIECE ALUMINUM DRIVESHAFT, AND MFAL BHDA (LESS SOUND INSULATION PACKS) – LOOSE/SAGGING UNDERBODY INSULATORS

SERVICE PROCEDURE

HYBRID ENGINES

Table Of Contents

Underbody Insulator Presence.....1
Inspection.....3
Driveshaft.....3
Zones 1, 3 and 4.....3
Zone 2.....5
ECT Sensor Connectors.....7
Remove Passenger Side Insulator.....8
Clean Sheet Metal Surface.....8
Secure Driver Side Insulator.....9
Appendix A - Acceptable Photos.....13

Underbody Insulator Presence

1. With the vehicle in NEUTRAL, position it on a hoist. Please follow Workshop Manual (WSM) procedures in Section 100-02.
2. Are either one or both of the underbody insulators present on the vehicle? See Figure 1.

Yes – Proceed to step 3.
No – This recall is complete.



NOTE: The driver side insulator is located directly above the fuel tank.

NOTE: The passenger side insulator is located directly above the exhaust.

NOTE: Insulators are highlighted for illustration purposes only.

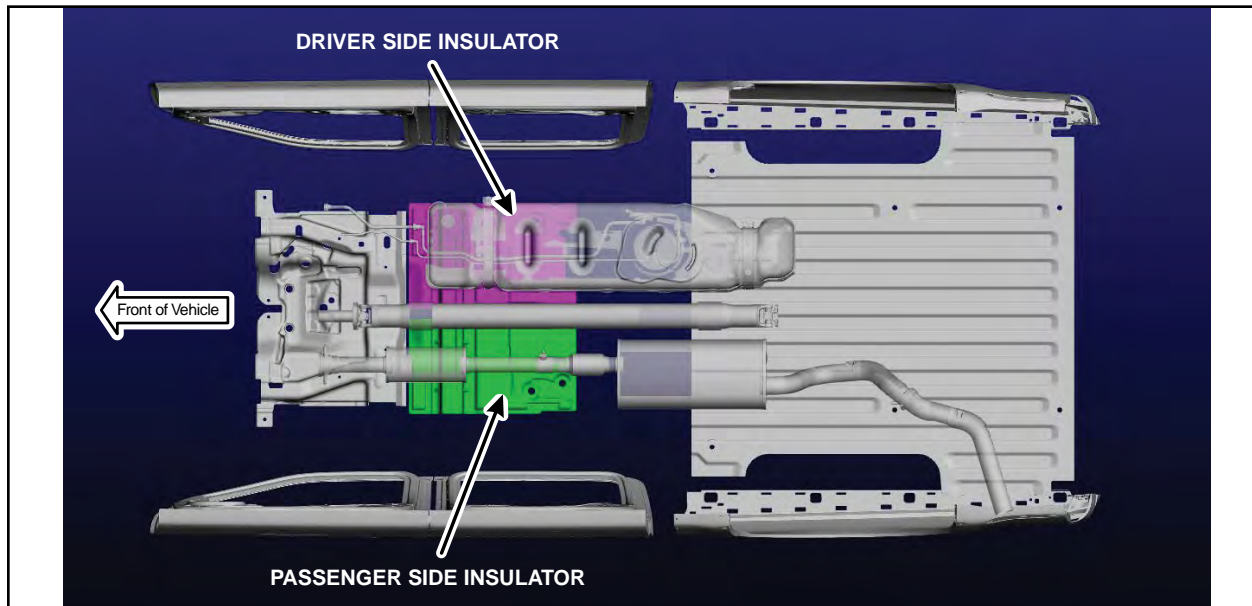

FIGURE 1

Review the video link below before starting this repair procedure:

 <https://bcove.video/3rdmqR0>

Materials List

Ruler/Scale/ Straight Edge	13 mm (1/2 in) Drill Stop	Small Brush
Drill	6.7 mm (17/64 in) Drill Bit	Marker
1/4" Rivet Gun	5.1 mm (13/64 in) Drill Bit – Rivet W719880-S417	Tape

NOTE: A 1/4" air over hydraulic rivet gun was used for the service trials for this program, however a pneumatic rivet gun or a manual rivet gun may also be used. However, it may not be possible to access and properly secure the rivets into the floor pan using a manual rivet gun. It is important to always confirm the rivet is properly secured to the floor pan of the vehicle.



Inspection

3. Remove the driveshaft. Please follow WSM procedures in Section 205-01.

NOTE: Do NOT discard the driveshaft flange to pinion flange bolts.

Zones 1, 3 and 4

4. Inspect Zones 1, 3 and 4 of the rear driveshaft for any marks caused by the front and/or rear edges of the passenger side insulator. Are there any marks present in Zones 1, 3 or 4?
See Figure 2.

Yes – Proceed to step 5.

No – Proceed to step 7.

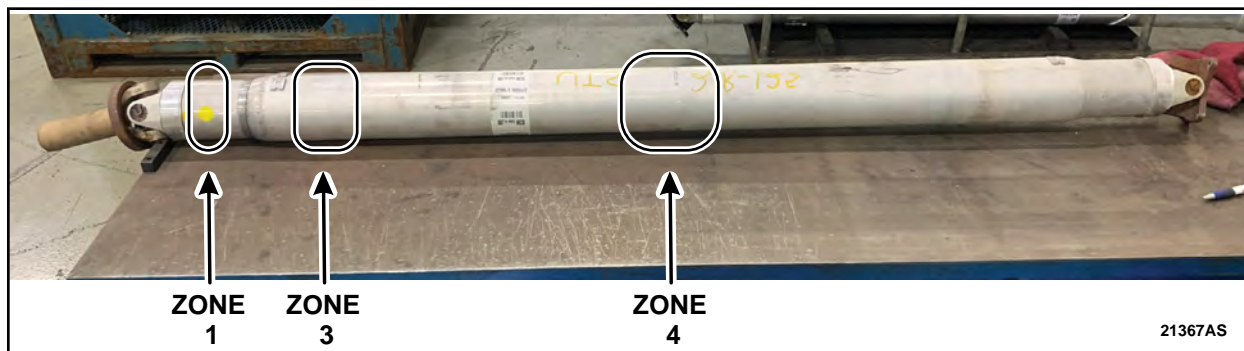

FIGURE 2

5. What is the current odometer reading?

> 2,500 miles – Proceed to step 6.

< 2,500 miles – Proceed to step 7.



6. Place a straight edge along the driveshaft over the wear mark and attempt to fit a 0.018in (0.45mm) feeler gauge between the flat edge and the wear mark. Can the feeler gauge fit between the straight edge and anywhere along the wear mark? See Figures 3 and 4.

Yes – Does not pass inspection. Contact the SSSC and provide a picture of the driveshaft with the feeler gauge fitting between the straight edge and wear mark. Once approved, rear driveshaft replacement will be required, but do not install at this time. Proceed to step 9.

No – Passes inspection. Proceed to step 7.

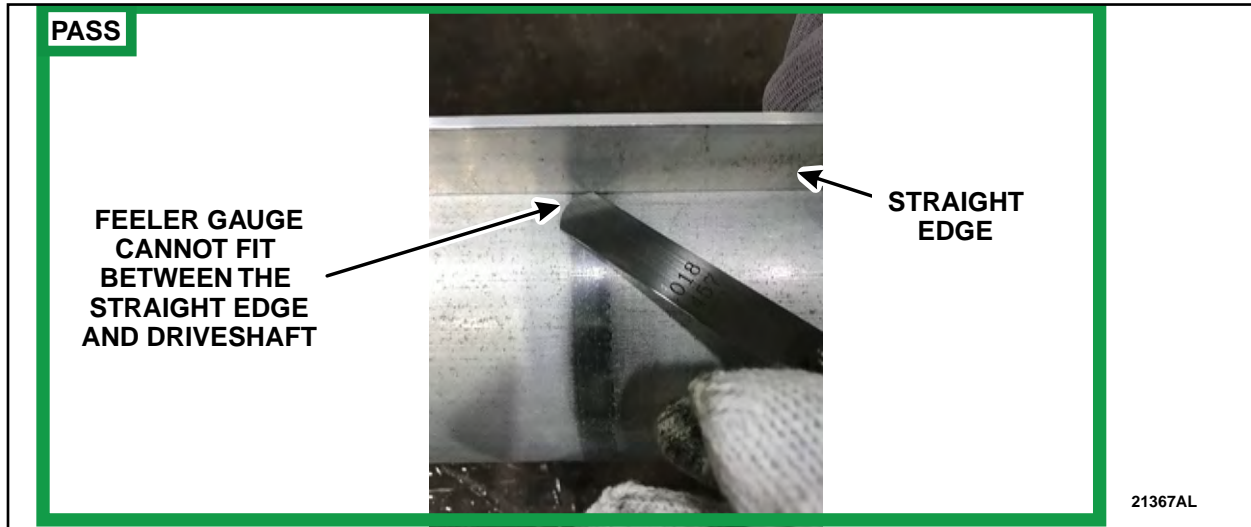

FIGURE 3

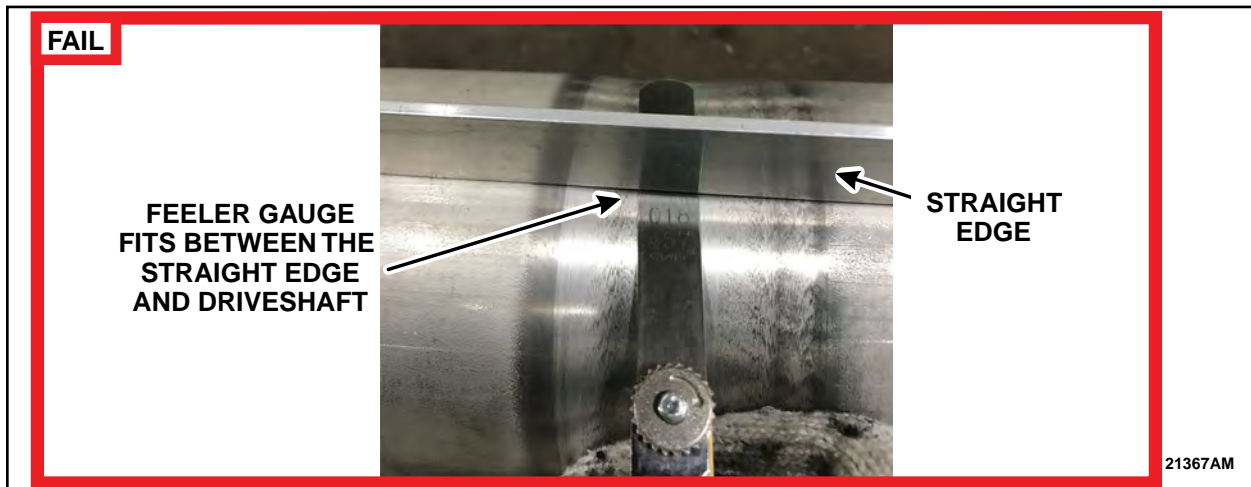

FIGURE 4



Zone 2

7. Inspect Zone 2 (transition from larger tube diameter to smaller diameter section) of the driveshaft tube for any marks caused by the front edge of the passenger side insulator. Are there any marks present? See Figure 5.

Yes – Does not pass inspection. Proceed to step 8.

No – Passes inspection. Driveshaft may be reused. Proceed to step 9.



FIGURE 5

8. Inspect the marks found on Zone 2. Is the aluminum tube surface grain pattern worn off, completely smooth, or have an appearance of necking? See Figures 6 through 9.

Yes – Does not pass inspection. Contact the SSSC and provide a picture of the driveshaft with the grain pattern worn off. Be sure to show a clear image of the grain pattern missing. Once approved, rear driveshaft replacement will be required, but do not install at this time. Proceed to step 9.

No – Passes inspection. Driveshaft may be reused. Proceed to step 9.

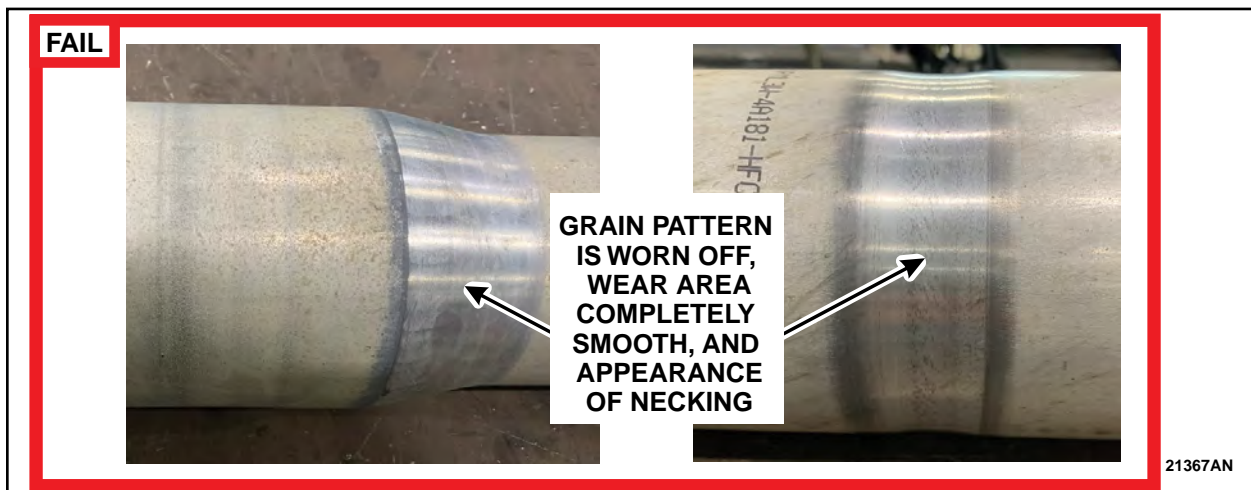

FIGURE 6



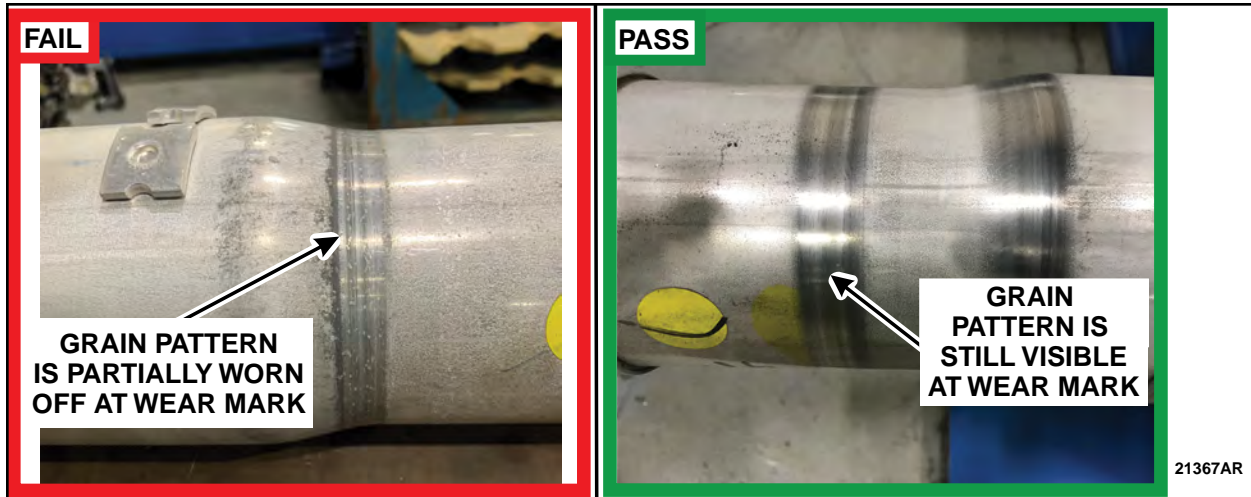

FIGURE 7

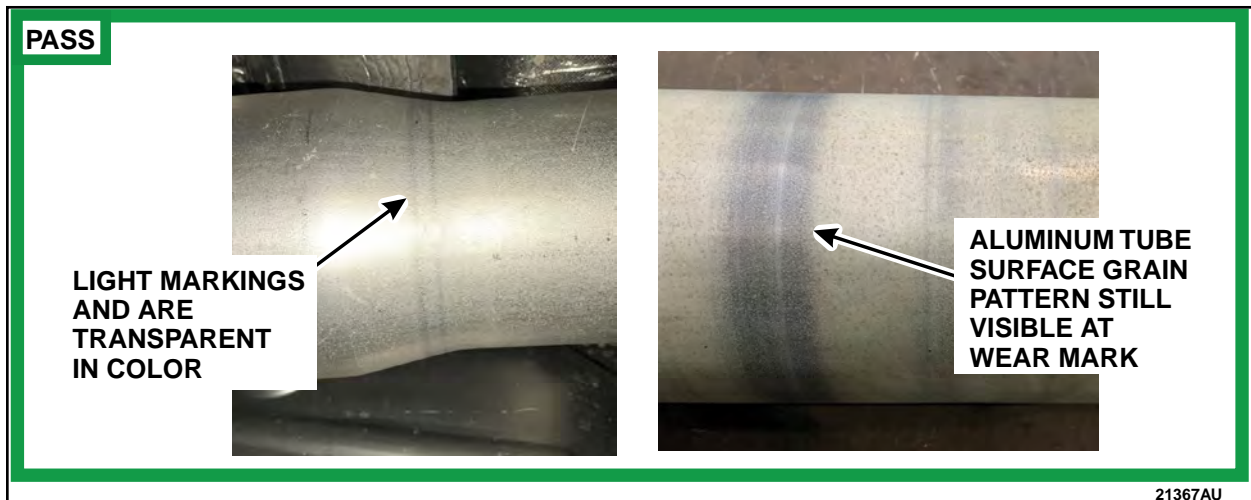

FIGURE 8



FIGURE 9



9. Inspect the front Engine Coolant Temperature (ECT) sensor connectors for any damage caused by the passenger side insulator. Is there any damage? See Figure 10.

Yes – Does not pass inspection. Contact the SSSC and provide a picture of the damage for proper technical instructions and part numbers, then proceed to step 10.

No – Proceed to step 10.

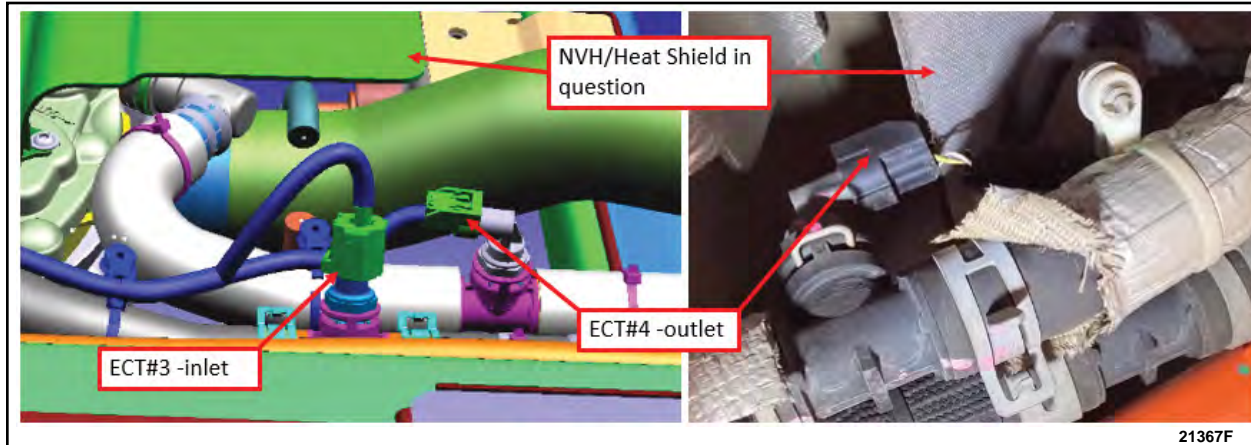

FIGURE 10



10. Is the passenger side insulator present on the vehicle?

Yes – Proceed to step 11.

No – Proceed to step 14.

Remove Passenger Side Insulator

11. Carefully remove and discard the passenger side insulator from the underside of the pickup bed. See Figure 11.

NOTE: Do NOT use metal scrapers, wire brushes, power sanding or grinding discs, or any abrasive means to clean surfaces. These tools cause scratches and gouges which make leak paths.

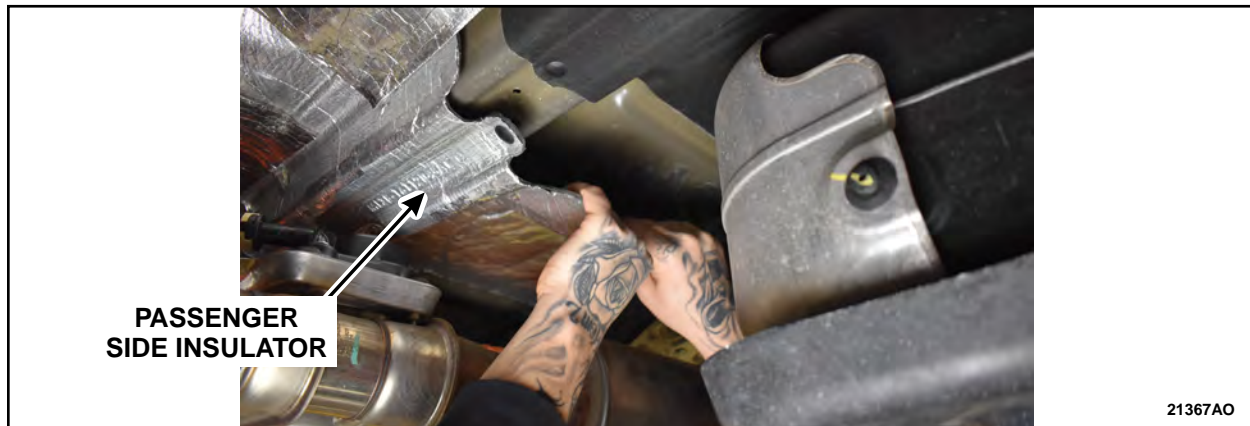

FIGURE 11

Clean Sheet Metal Surface

12. Using both hands and/or a plastic scraper, remove as much of the remaining substrate material as possible. See Figure 12.

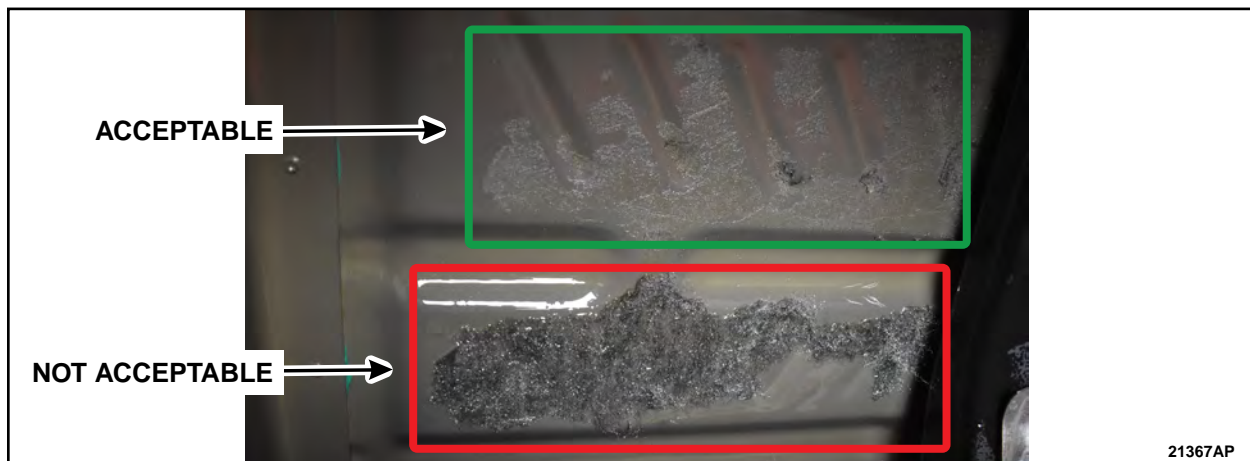

FIGURE 12

13. Using Mineral Spirits/Goo-Gone/3M Adhesive Remover/Brake Cleaner and lint-free rags or equivalent, clean the sheet metal surface.



Secure Driver Side Insulator

14 Measure and mark the one location on the driver side insulator. See Figures 13 and 14.

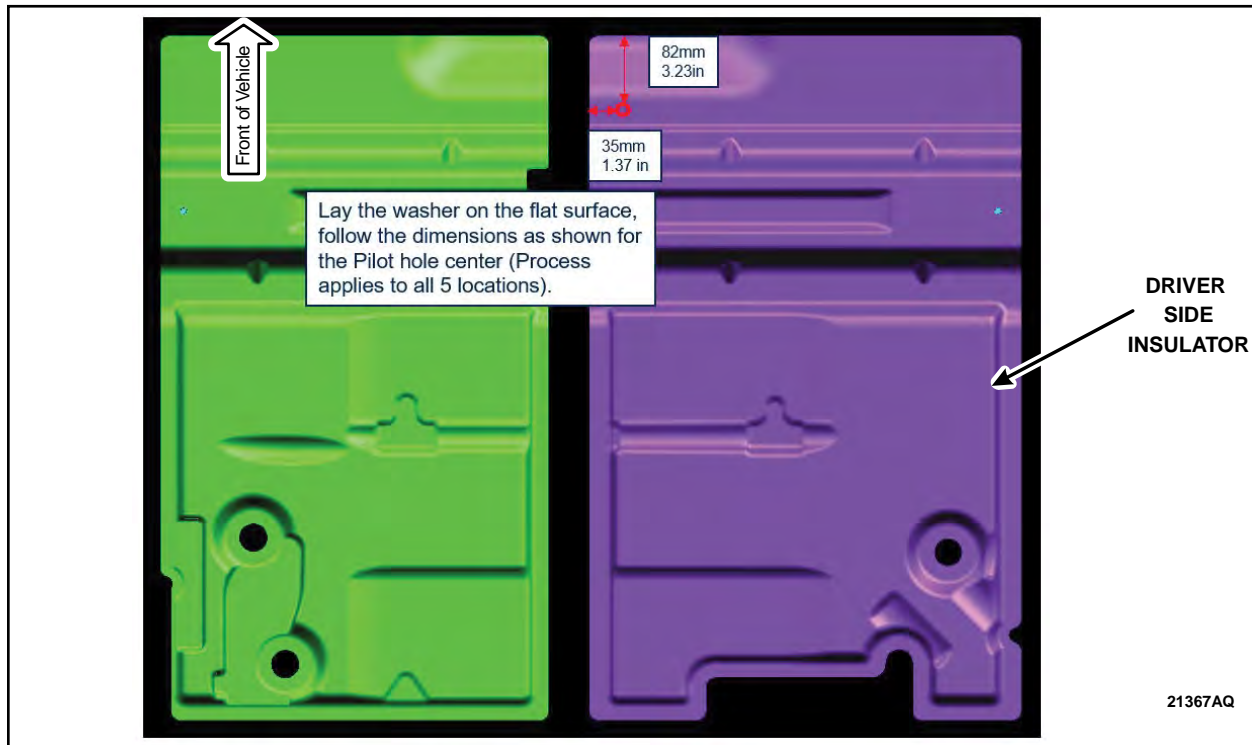

FIGURE 13

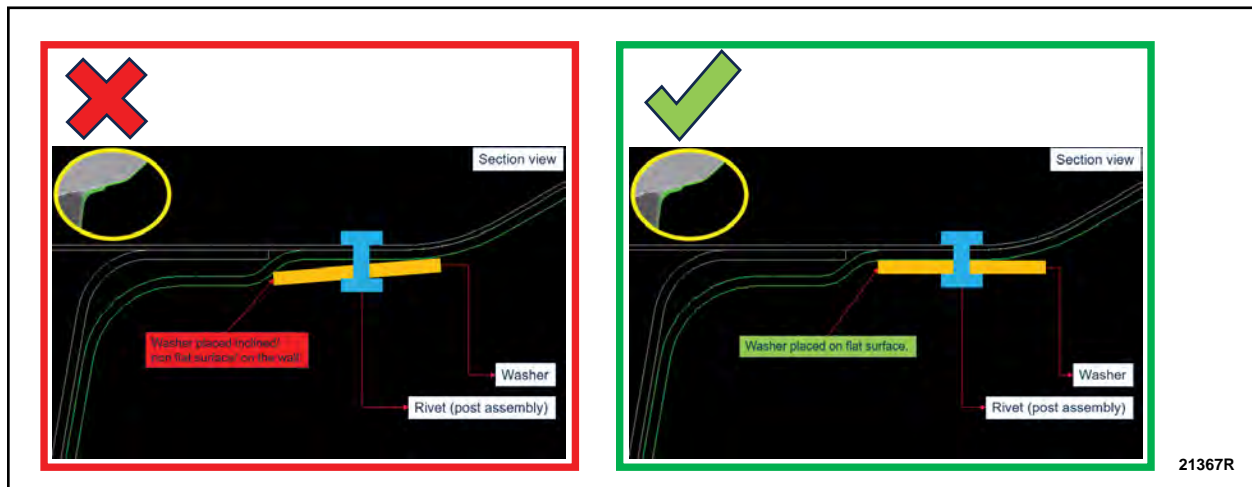

FIGURE 14



15. Use the 5.1 mm (13/64 in) drill bit for rivet part number W719880-S417 or the 6.7mm (17/64 in) drill bit for all other rivet part numbers to drill a hole through the insulator and into the floor. See Figure 15.

NOTE: Use the 13mm (1/2 in) drill stop to ensure you do not drill through the carpet.

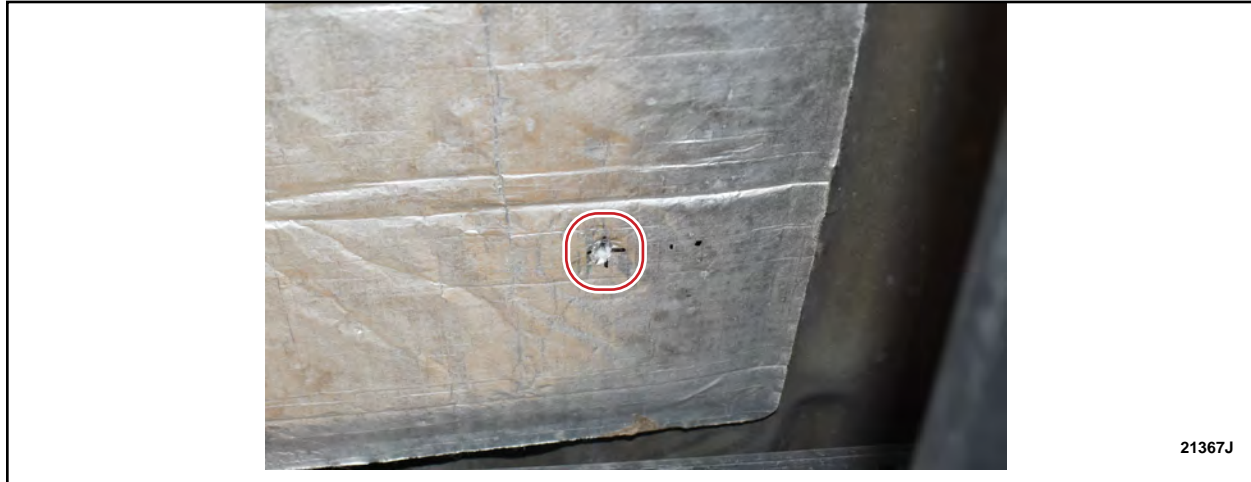

FIGURE 15

16. Using a small brush, apply a layer of the anti-corrosion coating to the edges of the newly drilled hole.
17. Install the washer onto the rivet. See Figure 16.

NOTE: All approved listed rivet part numbers may not look identical to the photos in the technical instructions.



FIGURE 16



18. Apply a thick layer of seam sealer to the rivet, and the backside of the washer. See Figure 17.



FIGURE 17

19. Using a 1/4" rivet gun, install the rivet and washer to the drilled hole. See Figure 18.

NOTE: To ensure the rivet is properly secured, apply as much force to the rivet gun as possible.

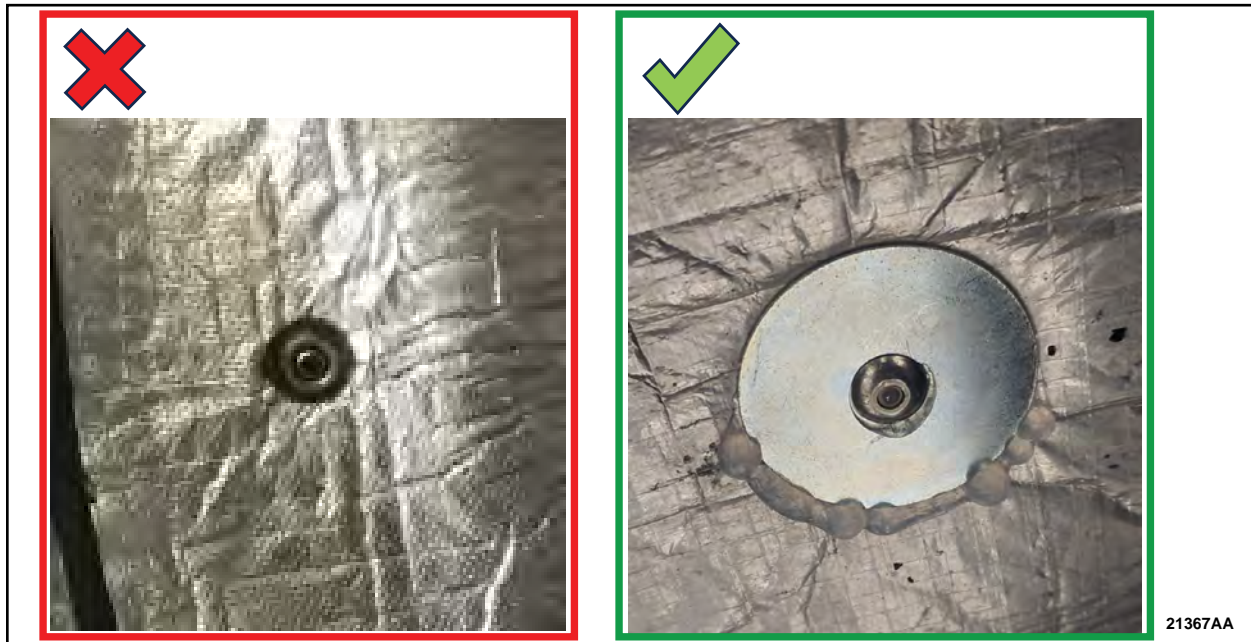

FIGURE 18

20. Attempt to move the washer/rivet to confirm it is properly secured.

21. Using a small brush, apply a layer of the anti-corrosion coating to the washer and rivet.



22. Using an air blow gun, remove any debris from threaded holes in axle flange. See Figure 19.

NOTE: Make sure that the mating faces are clean and free of foreign material.

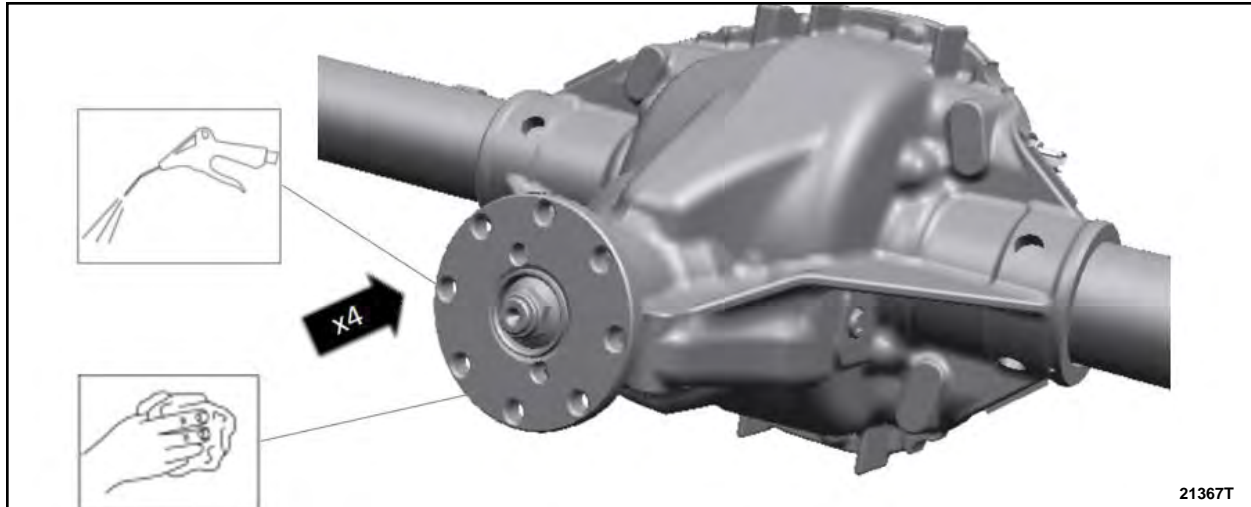

FIGURE 19

23. Inspect the original driveshaft flange to pinion flange bolts for rust in the threads and replace if rusted or damaged. Clean threads of the original driveshaft flange to pinion flange bolts with a wire brush and coat the threads with LOCTITE 243 Blue Medium Strength Threadlocker or equivalent. See Figure 20.

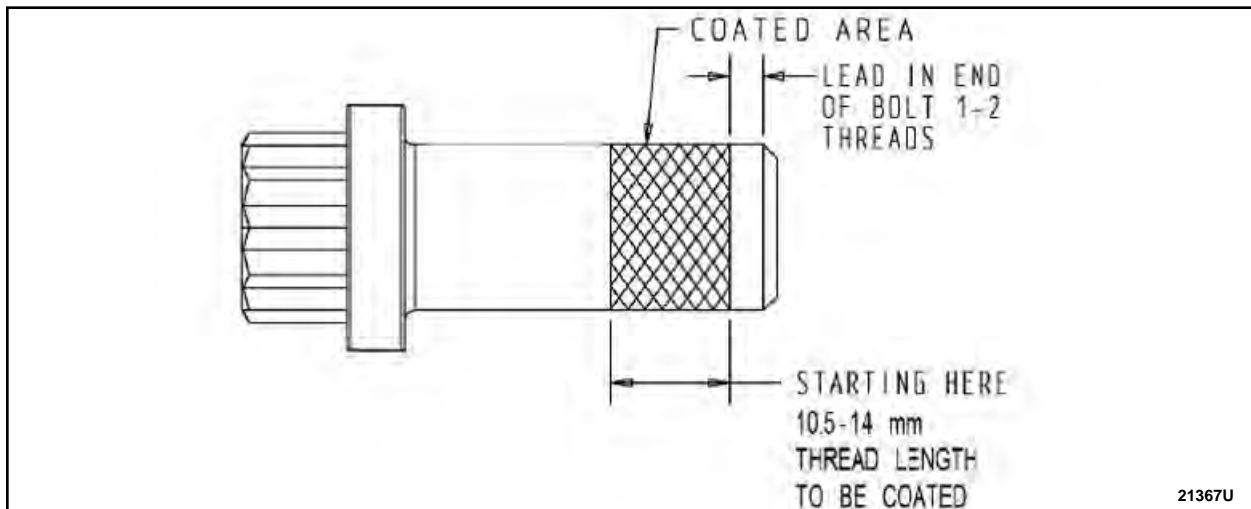

FIGURE 20

24. Install the driveshaft. Please follow WSM procedures in Section 205-01.



Appendix A – Acceptable Photos



FIGURE 21

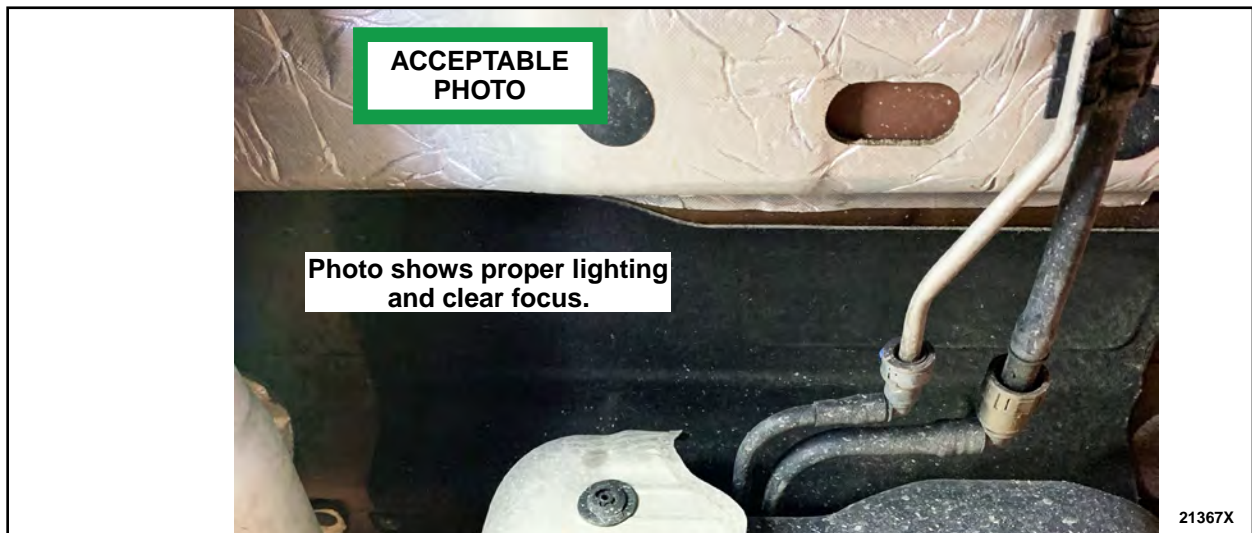

FIGURE 22



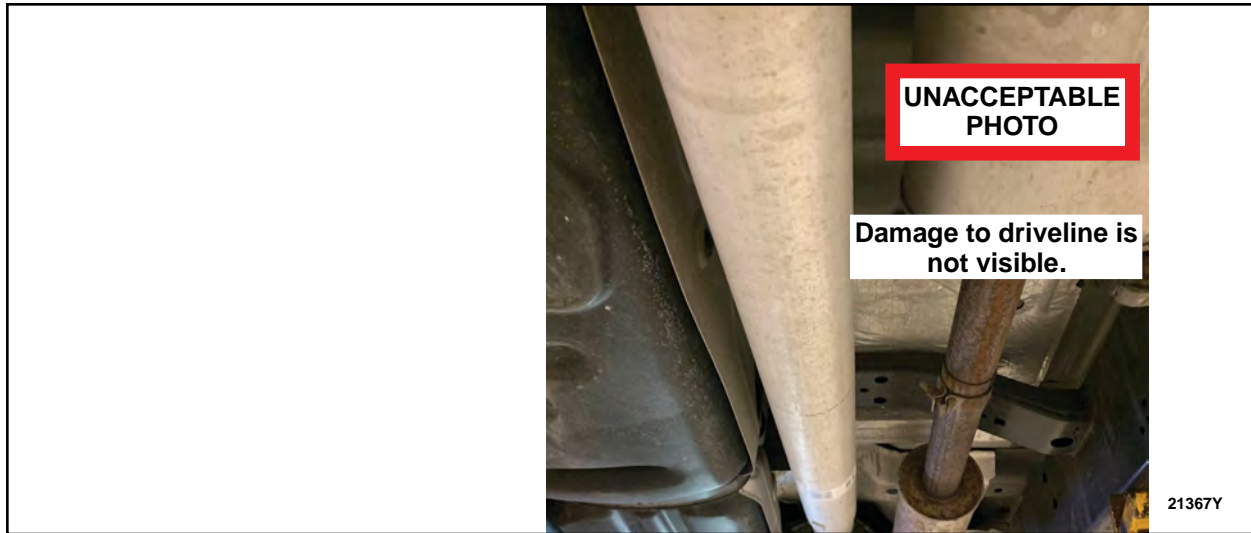

FIGURE 23



FIGURE 24



CERTAIN 2021-2022 MODEL YEAR F-150 VEHICLES EQUIPPED WITH A CREW CAB, 145" WHEELBASE, 4X4, ONE-PIECE ALUMINUM DRIVESHAFT, AND MFAL BHDA (LESS SOUND INSULATION PACKS) – LOOSE/SAGGING UNDERBODY INSULATORS

SERVICE PROCEDURE

GAS ENGINES – VEHICLES MANUFACTURED AT KANSAS CITY TRUCK ASSEMBLY PLANT

Table Of Contents

<i>Underbody Insulator Presence.....</i>	<i>1</i>
<i>Check for DTCs.....</i>	<i>3</i>
<i>Inspection.....</i>	<i>3</i>
<i>Driveshaft.....</i>	<i>3</i>
<i>Zones 1, 3 and 4.....</i>	<i>3</i>
<i>Zone 2.....</i>	<i>5</i>
<i>Secure Passenger Side Insulator.....</i>	<i>7</i>
<i>Appendix A - Acceptable Photos.....</i>	<i>11</i>

Underbody Insulator Presence

1. With the vehicle in NEUTRAL, position it on a hoist. Please follow Workshop Manual (WSM) procedures in Section 100-02.
2. Is the passenger side underbody insulator present on the vehicle? See Figure 1.

 Yes – Proceed to step 3.
 No – This recall is complete.

NOTE: If ONLY the driver side insulator is present, no action is required.



NOTE: The driver side insulator is located directly above the fuel tank.

NOTE: The passenger side insulator is located directly above the exhaust.

NOTE: Insulators are highlighted for illustration purposes only.

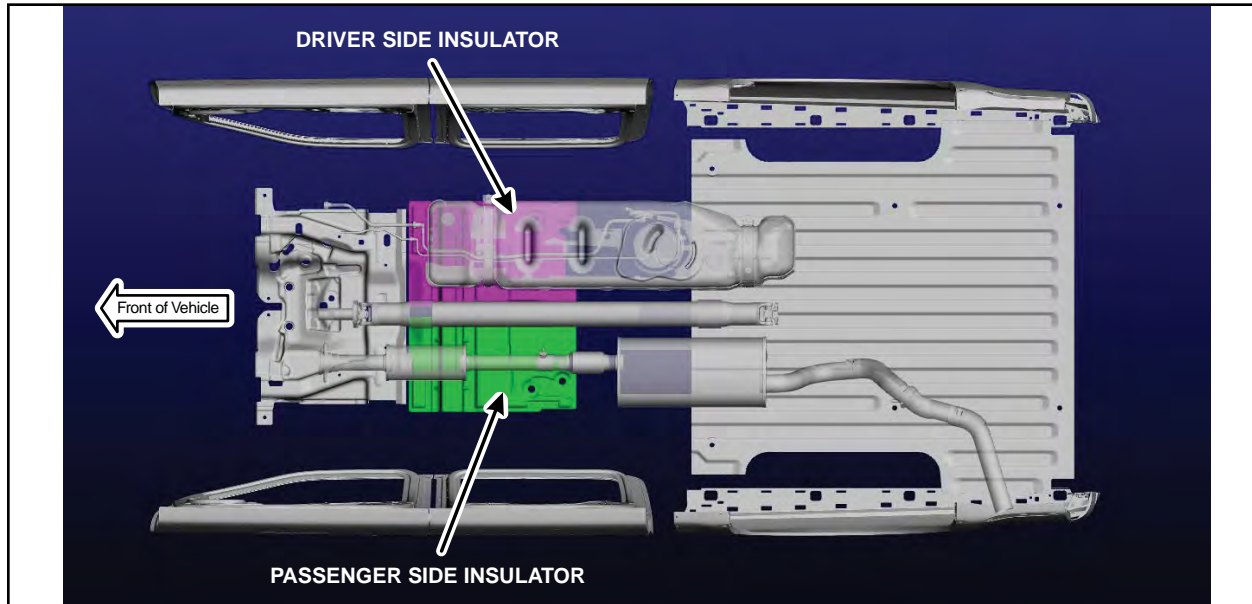

FIGURE 1

Review the video link below before starting this repair procedure:

 <https://bcove.video/3rdmqR0>

Materials List

Ruler/Scale/ Straight Edge	13 mm (1/2 in) Drill Stop	Small Brush
Drill	6.7 mm (17/64 in) Drill Bit	Marker
1/4" Rivet Gun	5.1 mm (13/64 in) Drill Bit – Rivet W719880-S417	Tape

NOTE: A 1/4" air over hydraulic rivet gun was used for the service trials for this program, however a pneumatic rivet gun or a manual rivet gun may also be used. However, it may not be possible to access and properly secure the rivets into the floor pan using a manual rivet gun. It is important to always confirm the rivet is properly secured to the floor pan of the vehicle.



Check for DTCs

- Using the Ford Diagnostic and Repair System (FDRS), check the Powertrain Control Module (PCM) for DTCs. Are either of the following DTC's present in the PCM, P0442 and/or P0456?

Yes - Please follow Workshop Manual (WSM) procedures for pinpoint test HX in Section 303-13, then proceed to step 4.
No - Proceed to step 4.

Inspection

- Remove the driveshaft. Please follow WSM procedures in Section 205-01.

NOTE: Do NOT discard the driveshaft flange to pinion flange bolts.

Zones 1, 3 and 4

- Inspect Zones 1, 3 and 4 of the rear driveshaft for any marks caused by the front and/or rear edges of the passenger side insulator. Are there any marks present in Zones 1, 3 or 4? See Figure 2.

Yes – Proceed to step 6.
No – Proceed to step 8.

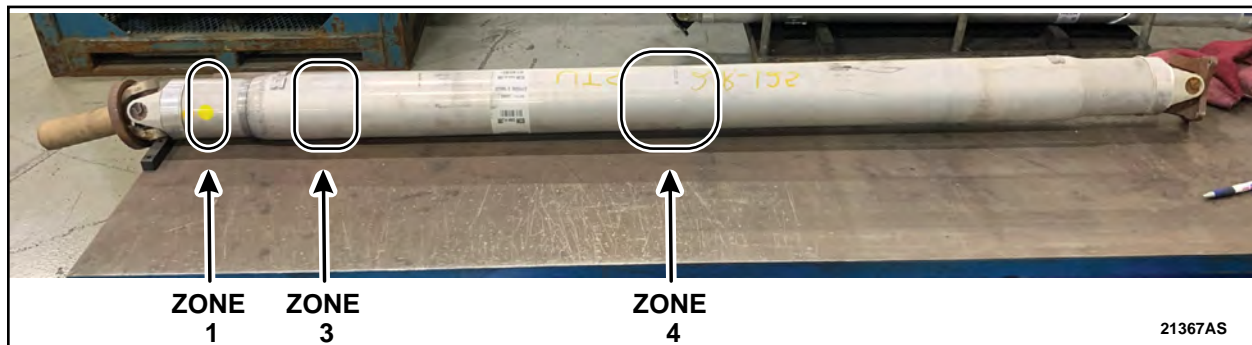

FIGURE 2

- What is the current odometer reading?

> 2,500 miles – Proceed to step 7.
< 2,500 miles – Proceed to step 8.



7. Place a straight edge along the driveshaft over the wear mark and attempt to fit a 0.018in (0.45mm) feeler gauge between the flat edge and the wear mark. Can the feeler gauge fit between the straight edge and anywhere along the wear mark? See Figures 3 and 4.

Yes – Does not pass inspection. Contact the SSSC and provide a picture of the driveshaft with the feeler gauge fitting between the straight edge and wear mark. Once approved, rear driveshaft replacement will be required, but do not install at this time. Proceed to step 10.

No – Passes inspection. Proceed to step 8.

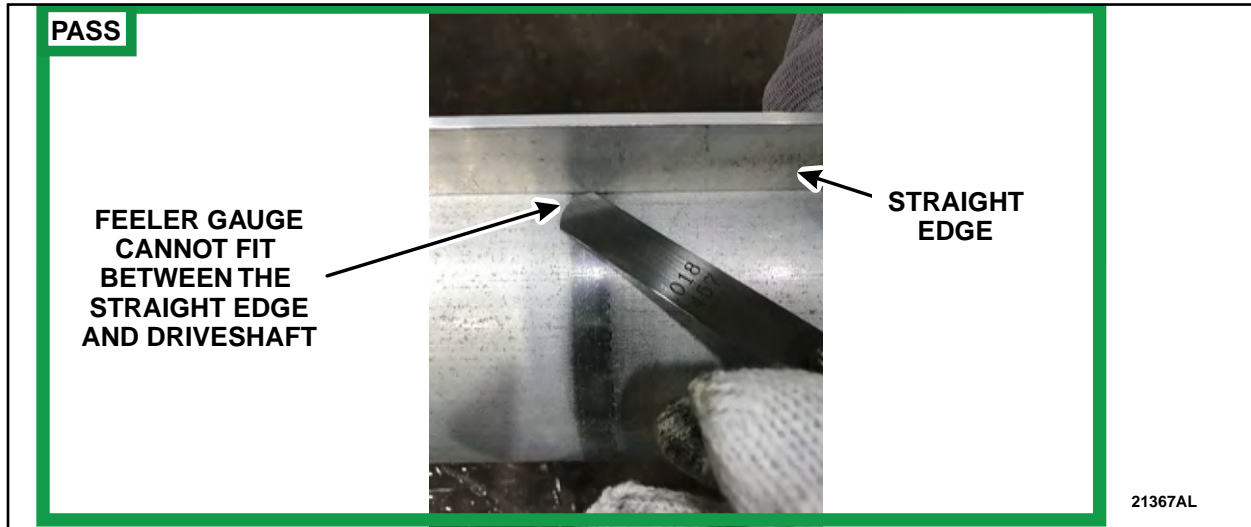

FIGURE 3

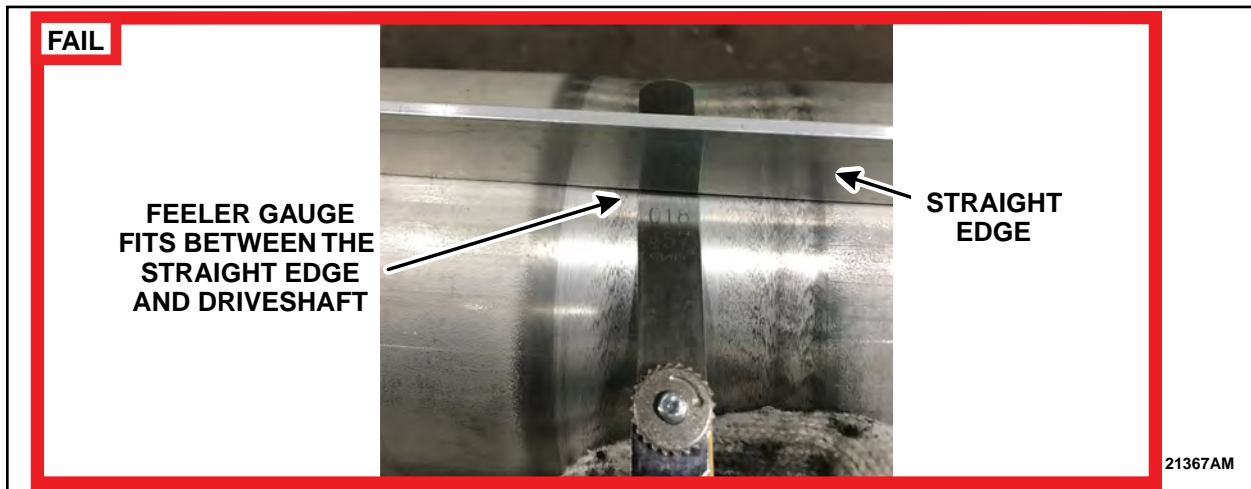

FIGURE 4



Zone 2

8. Inspect Zone 2 (transition from larger tube diameter to smaller diameter section) of the driveshaft tube for any marks caused by the front edge of the passenger side insulator. Are there any marks present? See Figure 5.

Yes – Does not pass inspection. Proceed to step 9.

No – Passes inspection. Driveshaft may be reused. Proceed to step 10.



FIGURE 5

9. Inspect the marks found on Zone 2. Is the aluminum tube surface grain pattern worn off, completely smooth, or have an appearance of necking? See Figures 6 through 9.

Yes – Does not pass inspection. Contact the SSSC and provide a picture of the driveshaft with the grain pattern worn off. Be sure to show a clear image of the grain pattern missing. Once approved, rear driveshaft replacement will be required, but do not install at this time. Proceed to step 10.

No – Passes inspection. Driveshaft may be reused. Proceed to step 10.

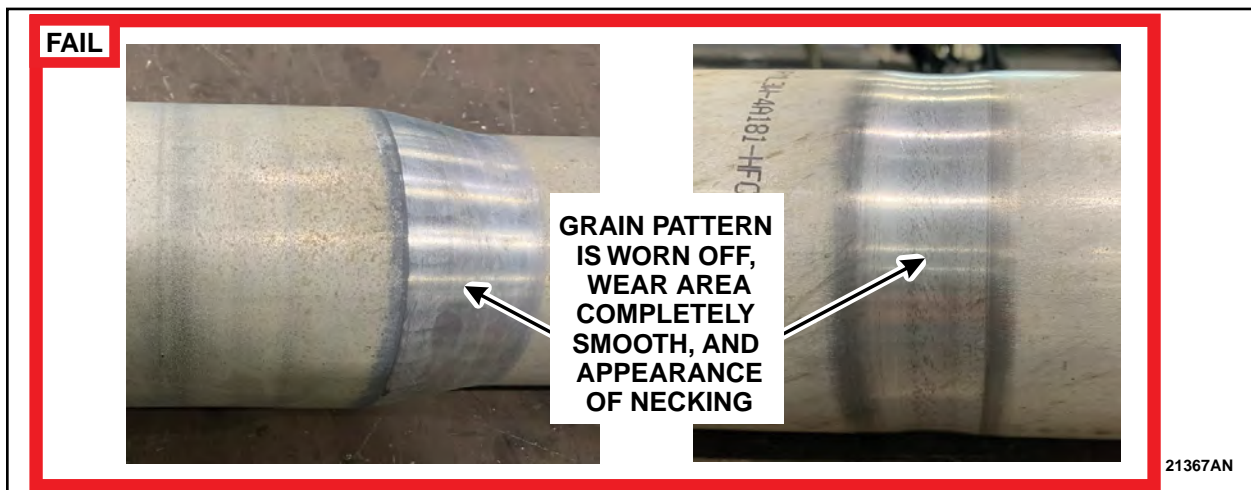

FIGURE 6



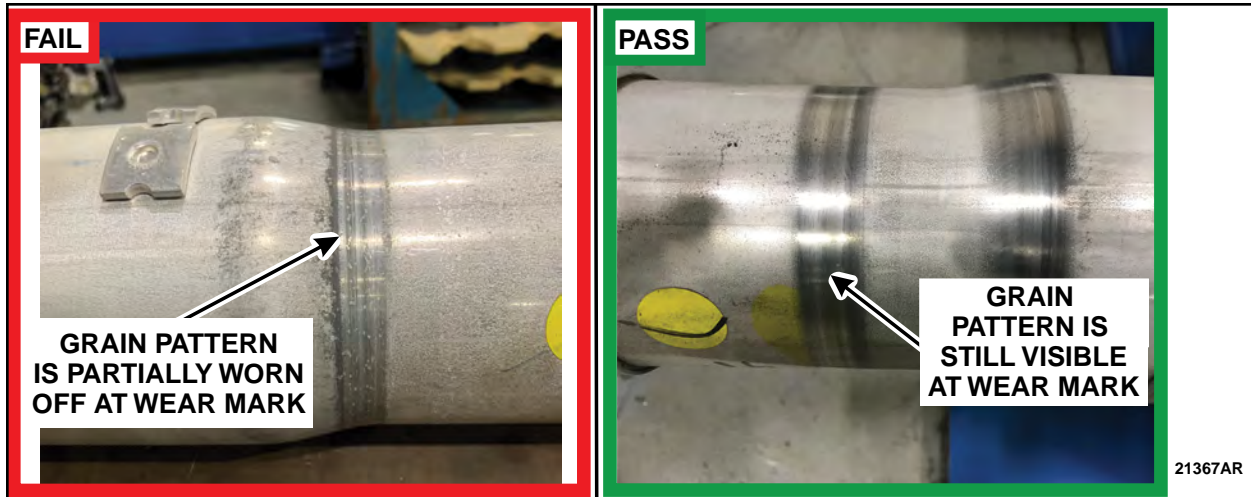

FIGURE 7

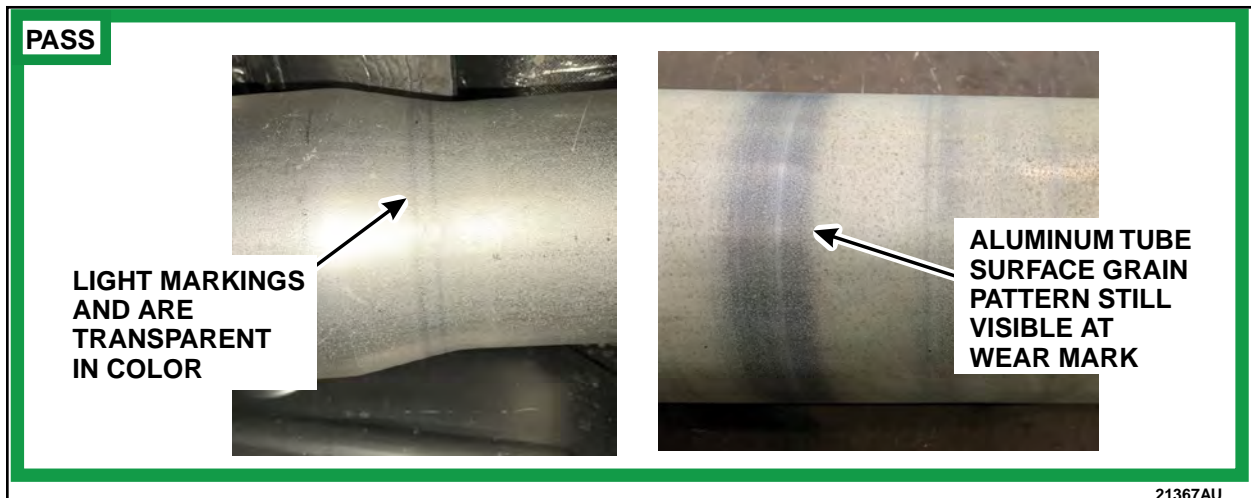

FIGURE 8



FIGURE 9



Secure Passenger Side Insulator

10. Measure and mark the two locations on the passenger side insulator. See Figure 10.

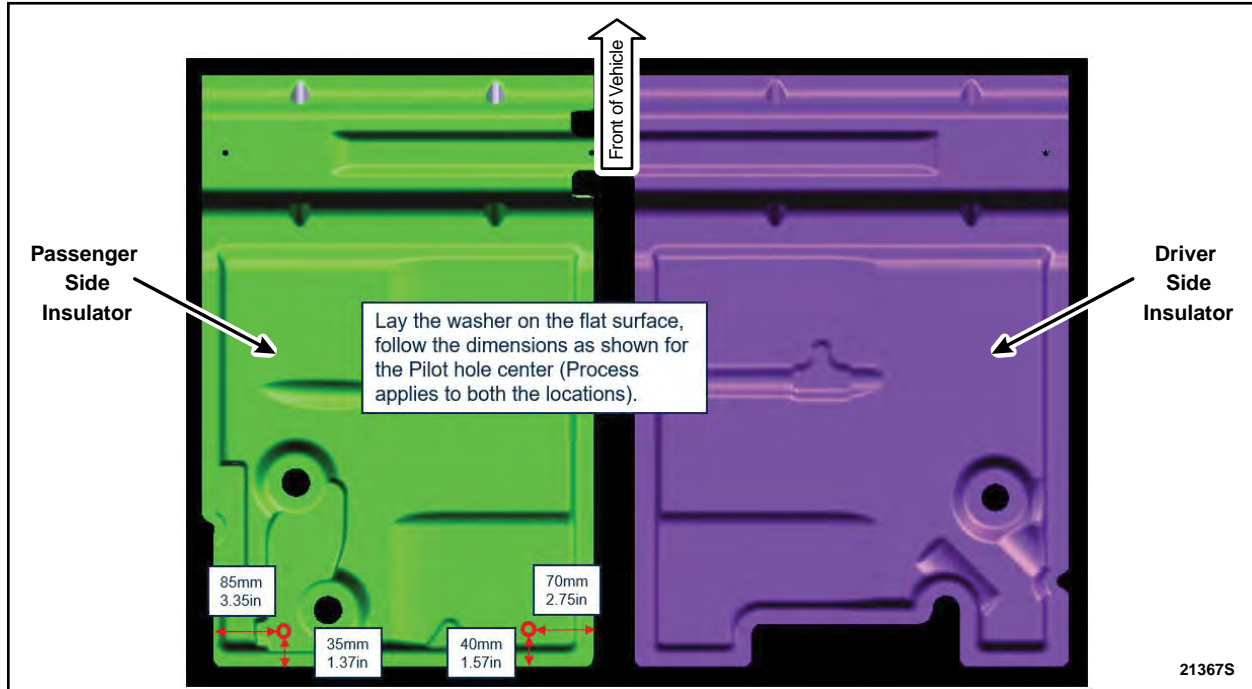

FIGURE 10

11. Use the 5.1 mm (13/64 in) drill bit for rivet part number W719880-S417 or the 6.7mm (17/64 in) drill bit for all other rivet part numbers to drill a hole through the insulator and into the floor. See Figure 11.

NOTE: Use the 13 mm (1/2 in) drill stop to ensure you do not drill through the carpet.

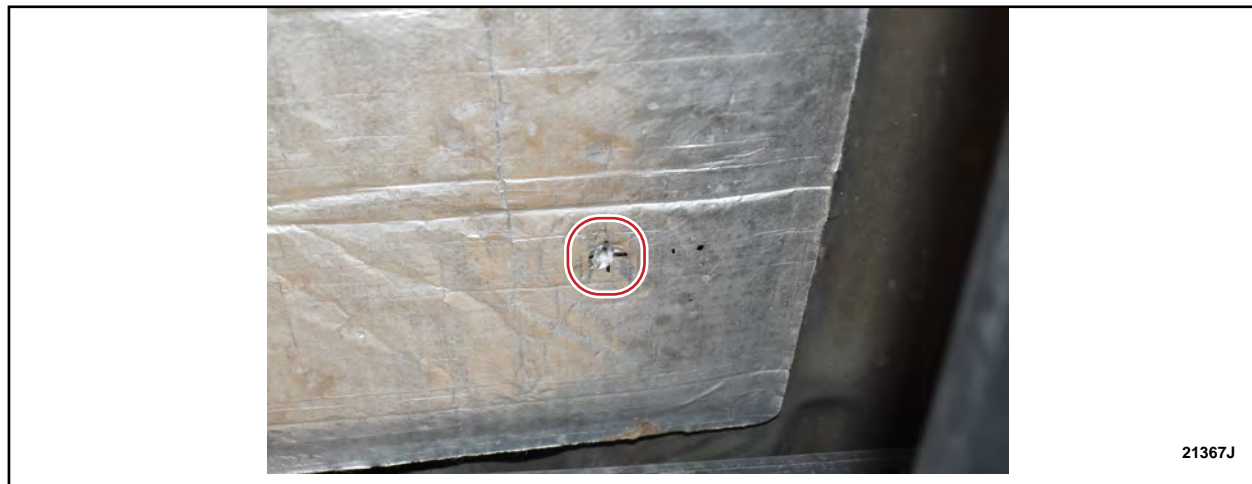

FIGURE 11



12. Repeat step 11 for the second marked location.
13. Using a small brush, apply a layer of the anti-corrosion coating to the edges of the newly drilled holes.
14. Install the washer onto the rivet. See Figure 12.

NOTE: All approved listed rivet part numbers may not look identical to the photos in the technical instructions.



FIGURE 12

15. Apply a thick layer of seam sealer to the rivet, and the backside of the washer. See Figure 13.



FIGURE 13



16. Using a 1/4" rivet gun, install the rivet and washer to the drilled hole. See Figure 14.

NOTE: To ensure the rivet is properly secured, apply as much force to the rivet gun as possible.

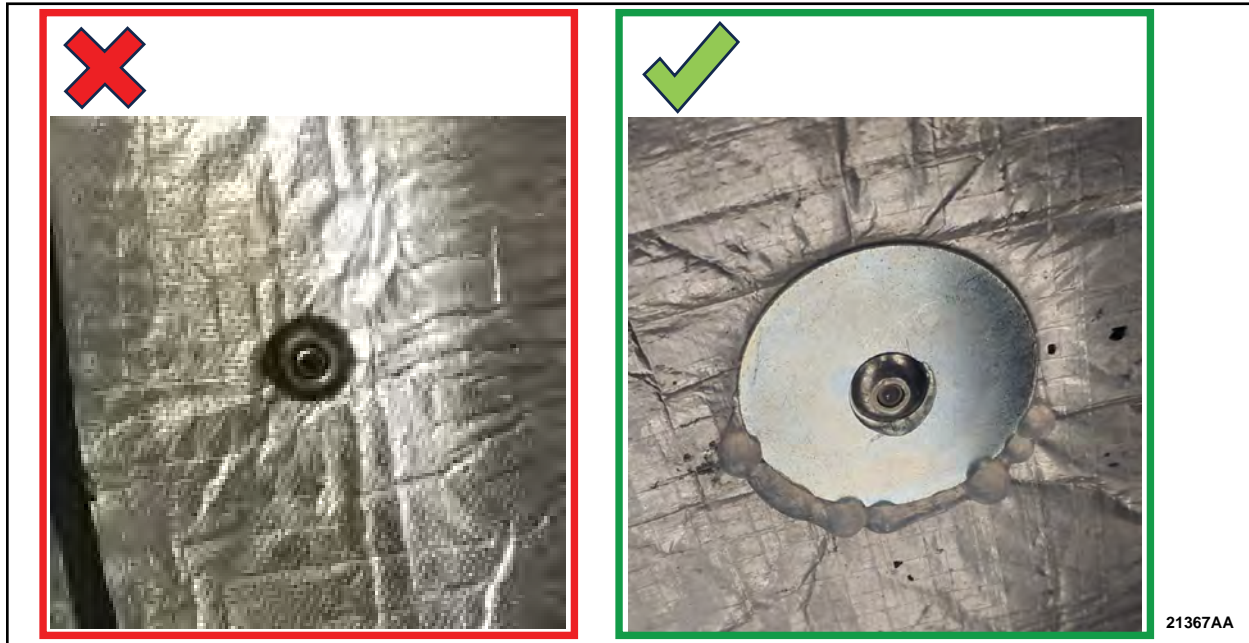

FIGURE 14

17. Attempt to move the washer/rivet to confirm it is properly secured.
18. Using a small brush, apply a layer of the anti-corrosion coating to the washer and rivet.
19. Repeat steps 14-18 for the second drilled hole.



20. Using an air blow gun, remove any debris from threaded holes in axle flange. See Figure 15.

NOTE: Make sure that the mating faces are clean and free of foreign material.

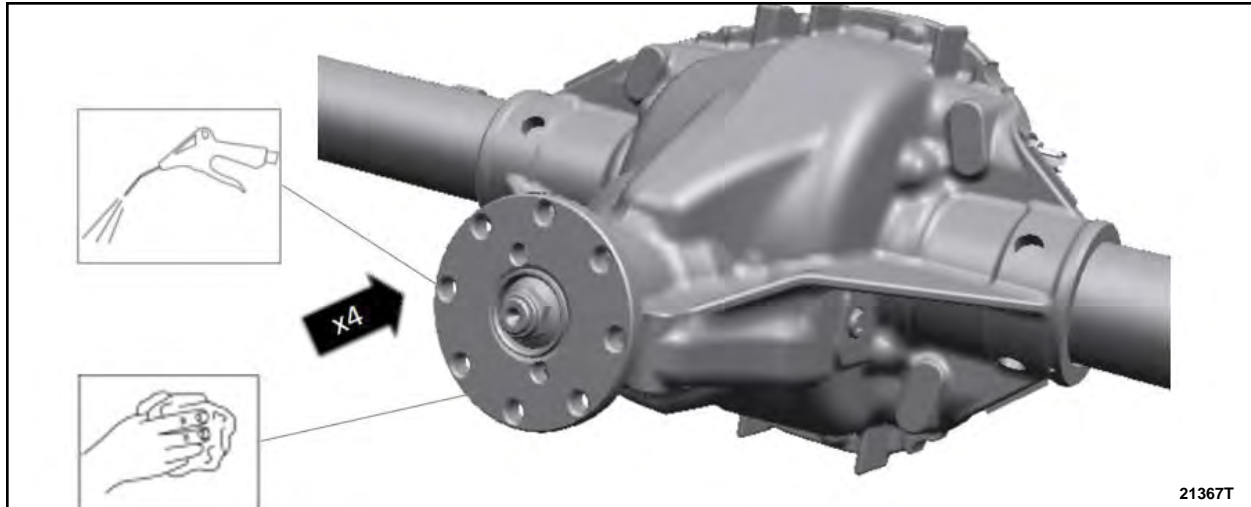

FIGURE 15

21. Inspect the original driveshaft flange to pinion flange bolts for rust in the threads and replace if rusted or damaged. Clean threads of the original driveshaft flange to pinion flange bolts with a wire brush and coat the threads with LOCTITE 243 Blue Medium Strength Threadlocker or equivalent. See Figure 16.

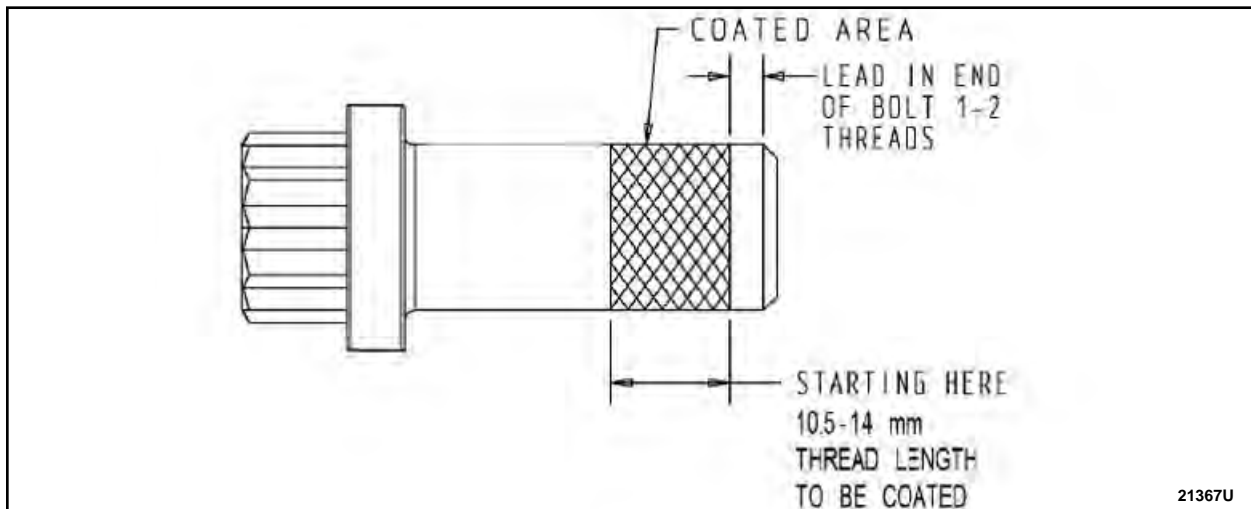

FIGURE 16

22. Install the driveshaft. Please follow WSM procedures in Section 205-01.



Appendix A – Acceptable Photos



FIGURE 17

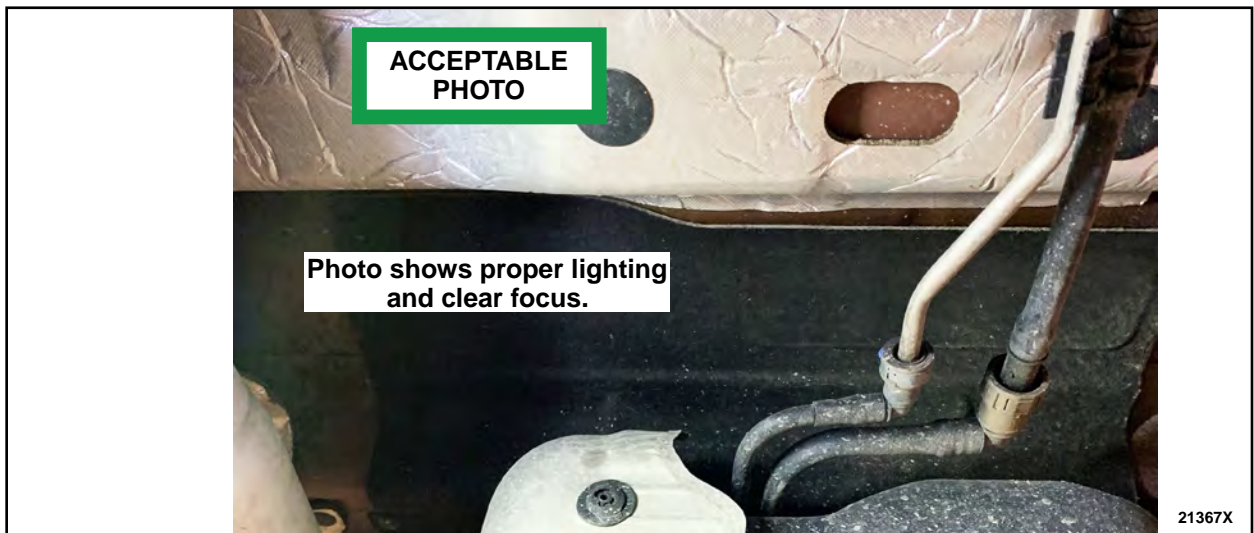

FIGURE 18



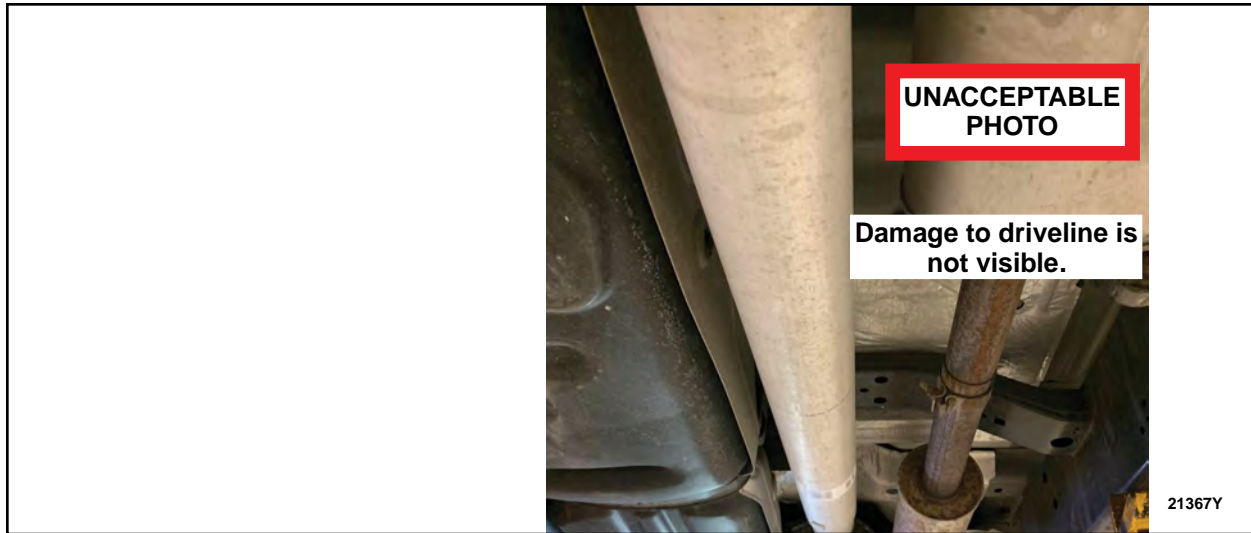

FIGURE 19



FIGURE 20



Ford Motor Company
Recall Reimbursement Plan for 22S53

Ford and Lincoln dealers are in the best position to quickly and efficiently process reimbursement requests. However, federal legislation requires all motor vehicle manufacturers to establish processes through which customers may seek recall reimbursement directly from the manufacturer or from the dealers.

Regarding the specific reimbursement plan for Recall # 22S53, owners who have paid for service to remedy the defect or noncompliance must have had that service performed prior to September 26, 2022. After this date, if repairs related to this recall are performed by a non-Ford repair facility in an emergency situation, customers must submit any refund requests through their dealership. As required by this federal regulation, Ford Motor Company submitted the details of its latest General Recall Reimbursement Plan in a letter to the National Highway Traffic Safety Administration (NHTSA) in May 2021. The following is the text of that letter and the Plan:

General Recall Reimbursement Plan
(As submitted to the NHTSA)

Pursuant to the requirements set forth in 49 CFR Part 573 and Part 577 of the Code of Federal Regulations, Ford Motor Company (Ford) is submitting required information pertaining to our general reimbursement plan for the cost of remedies paid for by vehicle owners before they are notified of a related safety recall.

Set forth below is Ford's general plan to reimburse owners and purchasers for costs incurred for remedies in advance of notification of potential safety-related defects or noncompliance's pursuant to Part 573.6 (c)(8)(i). This plan has not changed since our February 20, 2019 submission.

Reimbursement Notification

Ford's notice to a vehicle owner in accordance with 49 CFR Part 577 will indicate that Ford is offering a refund if the owner paid to have service to remedy the defect or noncompliance prior to a specified ending date. In accordance with Part 573.13 (c)(2), this ending date will be defined as a minimum of ten calendar days after the date on which Ford mailed the last of its Part 577 notifications to owners, and will be indicated in the specific reimbursement plan available to owners for an individual recall. This notice will direct owners to seek eligible reimbursement through authorized dealers or, at their option, directly through Ford at the following address:

Ford Motor Company
P.O. Box 6251
Dearborn, MI 48121-6251

Ford notes that this rule allows for the identification of a beginning date for reimbursement eligibility. Under the rule, an owner who paid to remedy the defect or noncompliance prior to the identified beginning date would not be eligible for reimbursement. Ford generally has not established such a beginning date for reimbursement eligibility and does not presently anticipate changing this general policy. However, in any case where Ford determines a beginning date is appropriate, Ford will indicate that date in the owner notice. As permitted by 577.11(e), Ford may not include a reimbursement notification when all vehicles are well within the warranty period, subject to approval by the agency.

Costs to be Reimbursed

For vehicles, reimbursement will not be less than the lesser of:

- The amount paid by the owner for the remedy that specifically addressed and was reasonably necessary to correct the defect or noncompliance that is the subject of the recall, or
- The cost of parts for the remedy (to be no more than the manufacturer's list retail price for authorized part(s), plus associated labor at local labor rates, miscellaneous fees (such as disposal of waste) and taxes.

For replacement equipment, reimbursement will be the amount paid by the owner for the replacement item (limited by the amount of the retail list price of the defective or noncompliant item that was replaced, plus taxes, where the brand or model purchased by the owner was different than the brand or model that was the subject of the recall). If the item of motor vehicle equipment was repaired, the reimbursement provisions identified above for vehicles will apply.

Ford notes that costs incurred by the owner within the period during which Ford's original or extended warranty would have provided for a free repair of the problem will not be eligible for reimbursement, as provided by Part 573.13 (d)(1).

Entities Authorized to Provide Reimbursement

Ford will continue to use authorized dealers to reimburse owners under the specific reimbursement plans for a particular recall, and will encourage owners to pursue requests for reimbursement directly through dealers to expedite reimbursement. Ford will also provide a mailing address to which customers can, at their option, send requests for reimbursement directly to Ford, as previously noted. Requests for reimbursement sent directly to Ford may take up to 60 days to process. Whether the owner chooses to pursue reimbursement requests through a dealer or directly through Ford, the owner will be directed to submit the required documentation, upon which reimbursement eligibility will be determined.

Required Documentation

The reimbursement determination will depend upon the information provided by the customer. Consistent with Part 573.13 (d)(4) the following information must be submitted:

- Claimant name and address
- Vehicle make, model, and model year
- Vehicle identification number (VIN) and, for replacement equipment, a description of such equipment or, for tires, the model, size and TIN (DOT code)
- Identification of the recall number (either the Ford recall number or the NHTSA recall number)
- Identification of the owner of the recalled vehicle at the time that the pre-notification remedy was obtained
- An original receipt for the pre-notification remedy that includes a breakdown of the amount for parts, labor, other costs and taxes, including costs for the replacement item. Where the receipt covers work other than to address the recall or noncompliance, Ford may require the claimant to separately identify costs that are eligible for reimbursement.
- If the remedy was obtained during the warranty period, documentation indicating that the warranty was not honored or the warranty repair did not correct the problem related to the recall.

Failure to submit all of the above information may result in denial of the reimbursement request.

Additional Information

The Part 577 required owner notice will provide a toll-free telephone number through which specific information about the reimbursement plan can be requested from Ford. This general reimbursement plan will be incorporated into notifications pursuant to Part 573.6 by reference. Information specific to an individual recall also may be incorporated into the Part 573.6 notification.