



Stacy L. Balzer  
 Director  
 Service Engineering Operations  
 Ford Customer Service Division

Ford Motor Company  
 P. O. Box 1904  
 Dearborn, Michigan 48121

February 6, 2024

**TO:** All U.S. Ford and Lincoln Dealers

**SUBJECT:** **NEW VEHICLE DEMONSTRATION / DELIVERY HOLD**  
**Safety Recall 22S27 - Supplement # 8**  
 Certain 2020-2022 Model Year Explorer Vehicles  
 Rear Axle Bolt Fractures

**REF:** **NEW VEHICLE DEMONSTRATION / DELIVERY HOLD**  
**Safety Recall 22S27 – Supplement # 7**  
 Dated: October 18, 2023

**New! REASON FOR THIS SUPPLEMENT**

- **Attachment VI Technical Information:** Updated torque specification values.
- **Claims Preparation:** Section added for locally obtained supplies.
- **Parts Requirements/Ordering Information:** Service parts information updated.

**AFFECTED VEHICLES**

Vehicle	Model Year	Assembly Plant	Build Dates
Explorer Police (3.3L Gas & 3.3L FHEV)	2020	Chicago Assembly /	November 10, 2018 through September 27, 2020
Explorer Police (3.3L Gas)	2021		July 24, 2020 through January 31, 2021
Explorer Police (3.3L FHEV)	2021		July 24, 2020 through October 31, 2020
Explorer	2020	Chicago SHO Center	October 22, 2018 through September 27, 2020
	2021		June 4, 2020 through November 10, 2021
	2022		July 3, 2021 through March 31, 2022

U.S. Population of affected vehicles is 224,413. Affected vehicles are identified in OASIS and FSA VIN Lists.

**REASON FOR THIS SAFETY RECALL**

In the affected vehicles, a rear axle mounting bolt may fracture during vehicle acceleration. A fractured rear axle bolt will allow the rear axle housing to move out of position, resulting in severe noise and vibration. If the rear axle bolt breaks, the driveshaft, or half shafts may become disconnected, resulting in loss of transmission torque to the rear wheels. Transmission torque is necessary to hold the vehicle in park and is also needed for the vehicle to move forward or backward. The loss of the primary park torque will allow the vehicle to roll in park if the parking brake is not applied, increasing the risk of crash and injury.

## **SERVICE ACTION**

DO NOT DEMONSTRATE OR DELIVER any new in-stock vehicles involved in this safety recall.

- **Police Units (VIN Positions 5-7 are K8A)** – Part availability:
  - **NOTE:** Police units will only have a physical part repair.
  - Parts are now available to perform all the repairs on affected Police Units.
- **Non-police Units** - Before demonstrating or delivering any new in-stock vehicles involved in this recall, dealers are to reprogram the powertrain control module (PCM) to the latest level. This PCM update will engage the electronic parking brake every time the vehicle is shifted into Park (P). An engaged parking brake will not allow the vehicle to roll. This service must be performed on all affected vehicles at no charge to the vehicle owner.
  - **NOTE:** All PCM calibrations are now available.

**IMPORTANT: Dealers should open a Repair Order (RO) only when a full dealer bulletin is published and parts/calibrations are available.**

## **OWNER NOTIFICATION MAILING SCHEDULE**

- **Police Units** –
  - Parts are now available in sufficient quantities and a new Police Owner Letter was mailed the week of June 12, 2023. Police vehicle owners can start scheduling an appointment to perform 22S27 at their dealerships, whether or not the customer has received a letter.
- **Non-Police Units** – Owner letters were mailed the week of June 6, 2022. Dealers are to check the Recall Landing page and repair any affected vehicles that arrive at their dealerships, whether, or not the customer has received a letter.

## **PLEASE NOTE:**

**Federal law requires dealers to complete this recall service before a new vehicle is delivered to the buyer or lessee. Violation of this requirement by a dealer could result in a civil penalty of up to \$27,168 per vehicle. Correct all vehicles in your new vehicle inventory before delivery.**

## **New! ATTACHMENTS**

Attachment I: Administrative Information  
*Attachment II: Labor Allowances and Parts Ordering Information*  
Attachment III: Technical Information - PCM Reprogram (Non-Police Units)  
Attachment IV: Customer Handout – PCM Reprogram  
Attachment V: Mobile Repair / Vehicle Pick-Up and Delivery Record  
*Attachment VI: Technical Information – Bushing Replacement (Police Units Only)*  
Attachment VII: Mobile Service Repair Assessment  
Owner Notification Letter  
Recall Reimbursement Plan

## **QUESTIONS & ASSISTANCE**

For questions and assistance, contact the Special Service Support Center (SSSC) via the SSSC Web Contact Site. The SSSC Web Contact Site can be accessed through the Professional Technician System (PTS) website using the SSSC link listed at the bottom of the OASIS VIN report screen or listed under the SSSC tab.

Sincerely,



Stacy L. Balzer

**NEW VEHICLE DEMONSTRATION / DELIVERY HOLD**  
**Safety Recall 22S27 - Supplement # 8**  
Certain 2020-2022 Model Year Explorer Vehicles  
Rear Axle Bolt Fractures

**MOBILE SERVICE REPAIR ASSESSMENT LEVEL**

Police vehicles have the following assessment level:

 - Not Mobile Service Capable

Non-Police vehicles have the following assessment level:

 - Mobile Reprogramming Capable

**MOBILE INSPECTION RECOMMENDATIONS**

- Mobile repair is only feasible on non-police units.
- Confirm with customer a mobile inspection is feasible.
- Check OASIS prior to going to the customer's home or business to confirm if any other outstanding FSA needs to be completed.
- Transportation – due to the simplicity of this repair, a specialty vehicle is not required.

**MOBILE INSPECTION ADDITIONAL INFORMATION**

Please ensure the technician brings the following to the mobile inspection destination:

- Printed Technical Instructions.
- Printed Customer Handout.
- Printed Mobile Repair / Vehicle Pick-Up and Delivery Record.
- Printed Repair/Work Order or any other necessary documentation as customer copy(s).
  - Documents could also be emailed to the customer.
- Charged cell phone, and laptop.
- Shirt/uniform and vehicle graphic with dealership or Ford logos are recommended.
- Recommended tools for repair: FDRS preloaded to the latest level.

**MOBILE INSPECTION QUESTIONS AND ASSISTANCE**

- For questions and assistance, contact the Special Service Support Center (SSSC) via the SSSC Web Contact Site. Work with dealership warranty administrator to create a SSSC contact ID#.
- Once an SSSC agent responds to the new contact ID#, you may opt to call the SSSC hotline: (800) 325-5621.

**MOBILE REPAIR CLAIMING QUESTIONS**

Dealers participating in the Remote Experience Program:

- Ford Dealers - refer to EFC14125, 2024 Remote Experience Program.
- Lincoln Retailers - refer to EFC14164, 2024 Remote Experience Program.

Dealers NOT participating in the 2024 Remote Experience Program:

- For questions and assistance, contact the Special Service Support Center (SSSC) via the SSSC Web Contact Site. Work with the Dealership warranty administrator to create an SSSC contact ID#.
- Once an SSSC agent responds to the new contact ID#, you may opt to call the SSSC hotline: (800) 325-5621.

**NEW VEHICLE DEMONSTRATION / DELIVERY HOLD**  
**Safety Recall 22S27 - Supplement # 8**  
Certain 2020-2022 Model Year Explorer Vehicles  
Rear Axle Bolt Fractures

**OASIS ACTIVATION**

OASIS was activated on April 19, 2022.

**FSA VIN LISTS ACTIVATION**

FSA VIN Lists have been available through <https://web.fsavinlists.dealerconnection.com> since April 19, 2022. Owner names and addresses have been available since June 24, 2022.

**NOTE:** Your FSA VIN Lists may contain owner names and addresses obtained from motor vehicle registration records. The use of such motor vehicle registration data for any purpose other than in connection with this recall is a violation of law in several states, provinces, and countries. Accordingly, you must limit the use of this listing to the follow-up necessary to complete this recall.

**SOLD VEHICLES**

- Ford has not issued instructions to stop selling/delivering or driving used vehicles under this safety recall. Owners should contact their dealer for an appointment to have their vehicles remedied as soon as practicable.
- Immediately contact any of your affected customers whose vehicles are not on your VIN list but are identified in OASIS. Give the customer a copy of the Owner Notification Letter (when available) and schedule a service date.
- Correct other affected vehicles identified in OASIS which are brought to your dealership.
- Dealers are to prioritize repairs of customer vehicles over repairs of new and used vehicle inventory.

**STOCK VEHICLES**

- Correct all affected units in your new vehicle inventory before delivery.
- Use OASIS to identify any affected vehicles in your used vehicle inventory.

**DEALER-OPERATED RENTAL VEHICLES**

The Fixing America's Surface Transportation (FAST) Act law effective June 2016 prohibits a rental company from selling, renting, or leasing vehicles subject to a safety or compliance recall. Please consult your legal counsel for legal advice.

**TITLE BRANDED / SALVAGED VEHICLES**

Affected title branded and salvaged vehicles are eligible for this recall.

**NEW VEHICLE DEMONSTRATION / DELIVERY HOLD**  
**Safety Recall 22S27 - Supplement # 8**  
Certain 2020-2022 Model Year Explorer Vehicles  
Rear Axle Bolt Fractures

**OWNER REFUNDS**

- **This safety recall must still be performed, even if the owner has paid for a previous repair. Claiming a refund will not close the recall on the vehicle.**
- Ford Motor Company is offering a refund for owner-paid repairs covered by this recall if the repair was performed prior to the date indicated in the reimbursement plan, which is posted with this bulletin. Owners are directed to seek reimbursement through authorized dealers or, at their option, directly through Ford Motor Company at P.O. Box 6251, Dearborn, MI 48121-6251.
- Dealers are also pre-approved to refund owner-paid emergency repairs that were performed away from an authorized servicing dealer after the end date specified in the reimbursement plan. Non-covered repairs, or those judged by Ford to be excessive, will not be reimbursed.
- Refunds will only be provided for the cost associated with rear axle bolt fracture repair.

**RENTAL VEHICLES**

Rental vehicles are not approved for this program.

**PICK-UP AND DELIVERY- Participating Dealers**

Dealers participating in the Remote Experience Program:

- Ford Dealers - Refer to EFC14125, 2024 Remote Experience Program, Pick-Up & Delivery Offset section for additional details.

**ADDITIONAL REPAIR (LABOR TIME AND/OR PARTS)**

Additional repairs identified as necessary to complete the FSA should be managed as follows:

- For related damage and access time requirements, refer to the Warranty and Policy Manual / Section 6 – Ford & Lincoln Program Policies / General Information & Special Circumstances for FSAs / Related Damage.
- For vehicles within new vehicle bumper-to-bumper warranty coverage, no SSSC approval is required, although related damage must be on a separate repair line with the “Related Damage” radio button checked.
  - Ford vehicles – 3 years or 36,000 miles
- For vehicles outside new vehicle bumper-to-bumper warranty coverage, submit an Approval Request to the SSSC Web Contact Site prior to completing the repair.

**CLAIMS PREPARATION AND SUBMISSION**

- **Claim Entry:** Enter claims using Dealer Management System (DMS) or One Warranty Solution (OWS) online.
  - When entering claims, select claim type 31: Field Service Action. The FSA number 22S27 is the sub code.
  - For additional claims preparation and submission information, refer to the Recall and Customer Satisfaction Program (CSP) Repairs in the OWS User Guide.

**NEW VEHICLE DEMONSTRATION / DELIVERY HOLD**  
**Safety Recall 22S27 - Supplement # 8**  
Certain 2020-2022 Model Year Explorer Vehicles  
Rear Axle Bolt Fractures

**New! CLAIMS PREPARATION AND SUBMISSION (Continued)**

- **Related Damage/Additional labor and/or parts:** Must be claimed as Related Damage on a separate repair line from the FSA with same claim type and sub code as described in Claim Entry above.  
**IMPORTANT:** Click the Related Damage Indicator radio button.
- **Refunds:** Submit refunds on a separate repair line.
  - Program Code: 22S27                      - Misc. Expense: ADMIN
  - Misc. Expense: REFUND                      - Misc. Expense: 0.2 Hrs.
  - Multiple refunds should be submitted on one repair line and the invoice details for each repair should be detailed in the comments section of the claim.
- **Pickup & Delivery:**
  - Dealers participating in the Remote Experience Program –
    - Refer to EFC14125, 2024 Remote Experience Program, Pick-Up & Delivery (PDL) Offset section for additional details.
- **Mobile Repair:**
  - Dealers participating in the Remote Experience Program –
    - Ford Dealers - refer to EFC14125, 2024 Remote Experience Program.
    - Lincoln Retailers - refer to EFC14164, 2024 Remote Experience Program.
  - Dealers NOT participating in the Remote Experience Program –
    - Mobile repair allowances can be claimed for dealer-performed mobile repairs. Dealers that are working with Ford-contracted mobile repair companies should refer to those companies for claiming instructions.
    - For dealer-performed mobile repairs, retain a copy of the Service Management signed record (see Attachment IV), with the repair order documentation.
    - Claim the mobile repair allowance Labor Operation Code 22S27MM along with the applicable Labor Operation Code for the repair (refer to the Labor Allowances table in Attachment II).
- ***Provision for Locally Obtained Supplies: Includes Loctite® 243 Blue Medium Strength Threadlocker or equivalent. Submit on the same line as the repair.***
  - *Program Code: 22S27*
  - *Misc. Expense: OTHER*
  - *Misc. Expense: Claim up to \$60*

**NEW VEHICLE DEMONSTRATION / DELIVERY HOLD**  
**Safety Recall 22S27 - Supplement # 8**  
Certain 2020-2022 Model Year Explorer Vehicles  
Rear Axle Bolt Fractures

**NEW LABOR ALLOWANCES**

Description	Labor Operation	Labor Time
Reprogram the PCM to the latest level. <b>(Non-Police units ONLY)</b>	22S27B	0.4 Hours
Mobile Service: <b>This allowance is only for non-eligible 2024 Remote Experience Program Dealers.</b> Can be used with 22S27B when repair takes place away from the dealership. If additional time is required due to travel, please submit an SSSC approval form <b>(Non-Police units ONLY)</b>	22S27MM	0.5 Hours
Replace the rear subframe bushing, mounting bolt, inspect rear differential cover. <b>(Police units ONLY)</b>	22S27C	2.5 Hours
Replace the rear subframe bushing, mounting bolt, inspect and <b>replace</b> rear differential cover. <b>(Police units ONLY)</b>	22S27D	3.1 Hours

**NOTE: Police units Only** claim only one labor operation 22S27C or 22S27D. There are no additional approved labor operations for vehicle inspection(s).

**New! PARTS REQUIREMENTS / ORDERING INFORMATION**

- NOTE:** Parts are now available to repair vehicles to support completion on all programs.

**Special Program Part Ordering:**

To place an order for the revised subframe bushing and differential axle housing cover (If required) submit a Special Program order in the DOW system. **SSSC contact is not required to order K-Coded parts on this program.** More information can be found in EFC 10642.

**NOTE:** Part numbers may change or supersede to a new service level service part number during the duration of this recall. For the latest and greatest part number, you may also refer to the parts catalog, enter vehicle specific VIN number and order the correct specific parts during the repair.

Part Number	Description	Order Quantity	Claim Quantity
L1MZ-4B425-D	Revised Rear Subframe Bushing	1	1
L1MZ-4033-C	Differential Axle Cover Housing <b>(ONLY if differential cover requires replacement)</b>	If Needed	

To guarantee the shortest delivery time, an emergency order for parts must be placed.

Dealers will be notified via a DOES II communication if circumstances warrant a change in part supply strategy and when open ordering resumes.



**NEW VEHICLE DEMONSTRATION / DELIVERY HOLD**  
**Safety Recall 22S27 - Supplement # 8**  
 Certain 2020-2022 Model Year Explorer Vehicles  
 Rear Axle Bolt Fractures

**New! PARTS REQUIREMENTS / ORDERING INFORMATION (Continued)**

Order the parts below through normal order processing channels:

Parts Required for Subframe Bushing Replacement		Order Quantity	Claim Quantity
W719362-S439	Toe Link to Knuckle Bolt (1 required – 4 in a pack)	1	1
W520516-S441	Toe Link to Knuckle Nut	1	1
W714297-S440	Lower Arm to Knuckle Nut (1 required – 2 in a pack)	1	1
W719459-S439	Upper Arm to Knuckle Bolt (1 required – 4 in a pack)	1	1
W520214-S440	Upper Arm to Knuckle Nut (1 required – 2 in a pack)	1	1
W720034-S440	Shock Absorber Lower Nut (1 required – 4 in a pack)	1	1
LB5Z-3B477-A	Wheel Hub Nut	1	1
W720988-S439	Differential Axle Rear Cover Housing Bolt to Rear Subframe (M14X118MM) (1 required – 4 in a pack)	1	1
W717822-S439	Driveshaft Center Bearing Bolts (2 required – 4 in a pack)	1	2
W719511-S439	Flexplate Coupling to Transmission Bolts (3 required – 4 in a pack)	1	3
XG-1-E1	Grease	As Required	
*-3B498-*	Rear Axle Pinion Circlip ( <b>All Applications</b> ) (Vehicle specific part number – Refer to parts catalog)	1	1
L1MZ-3B498-*	Rear - Inner Halfshaft Circlip ( <b>All Applications</b> ) (Vehicle specific part number – Refer to parts catalog)	2	2
L1MZ-3C084-A	Halfshaft Seal	2	2
W719430-S439	Brake Caliper Bolts (2 required – 4 in a pack)	1	2
VC-13-G	Motorcraft® Yellow Concentrated Antifreeze/Coolant <b>(3.3 Hybrid ONLY)</b>	As Required	
XY-75W85-QL	Differential Oil	2	2
<i>Obtain Locally</i>	<i>Loctite® 243 Blue Medium Strength Threadlocker or equivalent – Specification WSK-M2G349-A7. NOTE: If Threadlocker availability is not available in your Market, replace the required fasteners per Workshop Manual specifications.</i>	<i>1 tube will service many vehicles</i>	

Part Requirements are Continued on the next page.



**NEW VEHICLE DEMONSTRATION / DELIVERY HOLD**  
**Safety Recall 22S27 - Supplement # 8**  
 Certain 2020-2022 Model Year Explorer Vehicles  
 Rear Axle Bolt Fractures

**New! PARTS REQUIREMENTS / ORDERING INFORMATION (Continued)**

<b>Parts Required for Subframe Bushing Replacement</b>		<b>Order Quantity</b>	<b>Claim Quantity</b>
<b>TA-26</b>	Motorcraft® Red High Strength Threadlocker or equivalent – Specification WSK-M2G351-A6. <b>NOTE:</b> Check original fastener Threadlock color when removing, cleaning and re-using the fasteners. <b>NOTE:</b> If Threadlocker availability is not available in your Market, replace the required fasteners per Workshop Manual specifications.	1 tube will service many vehicles	

<b>Parts Required for Rear Differential Cover Replacement</b>		<b>Order Quantity</b>	<b>Claim Quantity</b>
TA-29	Silicone Sealant	As Required	

**DEALER PRICE**

For latest prices, refer to DOES II.

**PARTS RETENTION, RETURN, & SCRAPPING**

Follow the provisions of the Warranty and Policy Manual, Section 1 - WARRANTY PARTS RETENTION AND RETURN POLICIES. If a replaced part receives a scrap disposition, the part must be scrapped in accordance with all applicable local, state and federal environmental protection and hazardous material regulations. Federal law prohibits selling motor vehicle parts or components that are under safety, compliance, or emissions recall.

**EXCESS STOCK RETURN**

Excess stock returned for credit must have been purchased from Ford Customer Service Division in accordance with Policy Procedure Bulletin 4000.

**REPLACED FSA PARTS INSPECTION AND SIGN OFF**

Effective March 1<sup>st</sup> 2021 all parts replaced as part of an FSA repair with a repair order open date of March 1<sup>st</sup> 2021 or later must be inspected and signed off on the repair order by a member of your dealers fixed operations management team or an employee the task has been delegated to. If the task is to be delegated to a non-management employee, the employee needs to be someone other than the technician who completed the repair and needs to understand the importance of completing this task consistently and accurately.

- All parts replaced as part of an FSA repair should be returned to the parts department following the Warranty Parts Retention and Return Policies.
- Inspect the replaced parts to verify the FSA repair was completed.
- If the FSA repair is found to be complete, the designated employee signs the repair order line or parts return stamp area (electronic or hand signed) for the FSA repair indicating the parts were inspected and validated to have been replaced.

**NEW VEHICLE DEMONSTRATION / DELIVERY HOLD**  
**Safety Recall 22S27 - *Supplement # 8***  
Certain 2020-2022 Model Year Explorer Vehicles  
Rear Axle Bolt Fractures

**REPLACED FSA PARTS INSPECTION AND SIGN OFF (*Continued*)**

- After the parts have been inspected, they should be handled based on the guidance in the parts status report in the Online Warranty System (Hold, Return, CORE, Scrap, etc.). Please visit FMCDEALER > PARTS & SERVICE > WARRANTY ADMINISTRATION & WARRANTY PARTS RETURN for the latest [Immediate Scrap List](#) information.
- This process is subject to review during warranty audits for FSA repairs with a repair order open date of March 1<sup>st</sup>, 2021, or later. Any eligible FSA claims requiring parts replacement found not to have been inspected and signed off during a warranty audit will be subject to chargeback and consideration for enrollment into the Dealer Incomplete Recall Repair Process.

**Note:** Other approvals (electronic or handwritten) for add-on repair lines, dealer-owned vehicle repairs, and repeat repairs do not qualify as FSA parts inspection approvals. The post-repair FSA parts inspection process (electronic or handwritten) is independent of other warranty approval requirements. The approval by the designated employee implies that the FSA parts were found to be replaced and must be able to be identified on the Repair Order. If multiple FSAs require approval on a single Repair Order, each applicable occurrence will require individual post-repair approval by the designated employee.

## CERTAIN 2020 - 2022 MODEL YEAR EXPLORER VEHICLES — EQUIPPED WITH A 3 BOLT DIFFERENTIAL HOUSING BUSHING REPLACEMENT (POLICE UNITS ONLY)

### **NEW !** SERVICE PROCEDURE

 **IMPORTANT!** *This procedure was modified from the original Workshop Manual (WSM) procedure. For this Field Service Action (FSA), multiple bolts and nuts will be cleaned and inspected for re-use. Follow these technical instructions carefully.*

**NOTE:** *If you do not have the special tools referenced in the Workshop Manual (WSM) to perform the FSA repair, please contact 1-800 ROTUNDA and choose option 3 to place an order.*

1. Measure the distance from the center of the hub to the lip of the quarter panel with the vehicle in a level, static ground position (curb height).

2. Drain the rear differential fluid. Follow the Workshop Manual (WSM) procedures in Section 205-02.

**NOTE:** For this procedure it is not necessary to remove the wheel bearing, wheel hub, brake disc shield or lower arm vertical link.

**NOTICE:** Never pick up or hold the halfshaft by only the inner or outer CV joint. Damage to the CV joint will occur.

**NOTICE:** Never use a hammer to remove or install the halfshafts. Damage to the CV joint may occur.

**NOTICE:** Never use the halfshaft assembly as a lever to position other components. Damage to the halfshaft or CV joint may occur.

**NOTICE:** Do not allow the boots to contact sharp edges or hot exhaust components. Damage to the halfshaft boots will occur.

**NOTICE:** Do not drop assembled halfshafts. The impact may cut the boots from the inside without evidence of external damage.

**NOTICE:** Suspension fasteners are critical parts that affect the performance of vital components and systems. Failure of these fasteners may result in major service expense. Use the same or equivalent parts if replacement is necessary. Do not use a replacement part of lesser quality or substitute design. Tighten fasteners as specified.

**NOTE:** Only remove the Left Hand (LH) side halfshaft.

3. Remove the rear wheels and tires. Follow the WSM procedures, in Section 204-04A.



**NOTICE:** Do not attempt to jacking on the front control arm or rear control arm on any vehicle.  
Damage to control arms may occur.

**NOTICE:** Make sure that the insulator pads are correctly positioned to prevent direct contact with other components.

4. Use a suitable jack to raise the suspension until the distance between the center of the hub and the lip of the fender is equal to the measurement taken during removal (curb height). See Figure 1.

**NOTE:** The below procedures are only for the LH side.

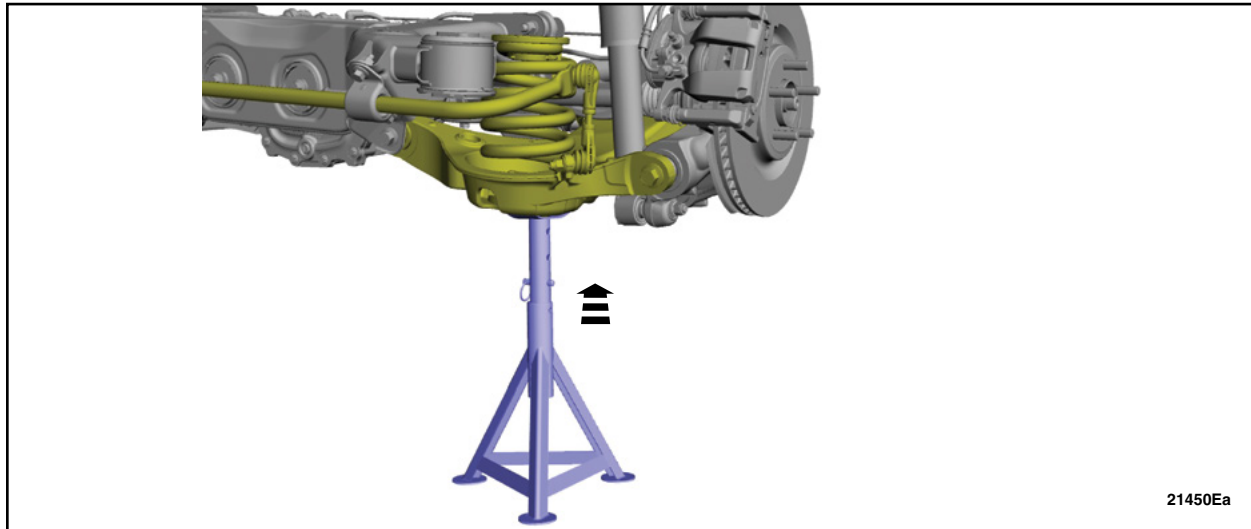

**FIGURE 1**

5. Remove and discard the wheel hub nut. See Figure 2.

• Torque: 300 Nm (221 lb.ft).

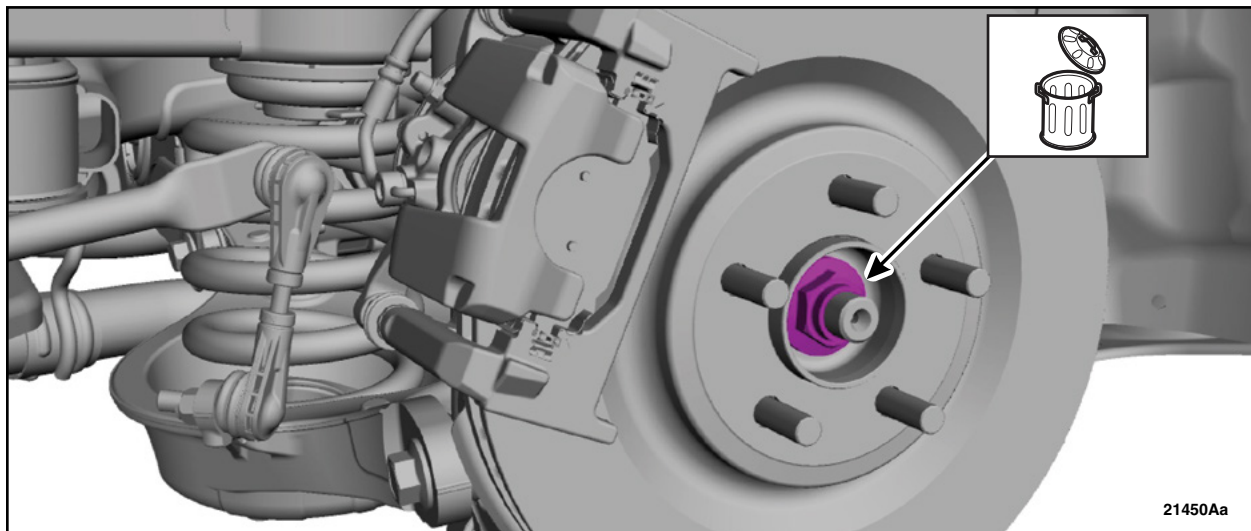

**FIGURE 2**



6. Remove the brake disc. Follow the WSM procedures in Section 206-03.

**NOTE:** Only remove the LH side brake disc.

7. Remove and discard the rear shock absorber lower nut. See Figure 3.

• Torque: 80 Nm (59 lb.ft).

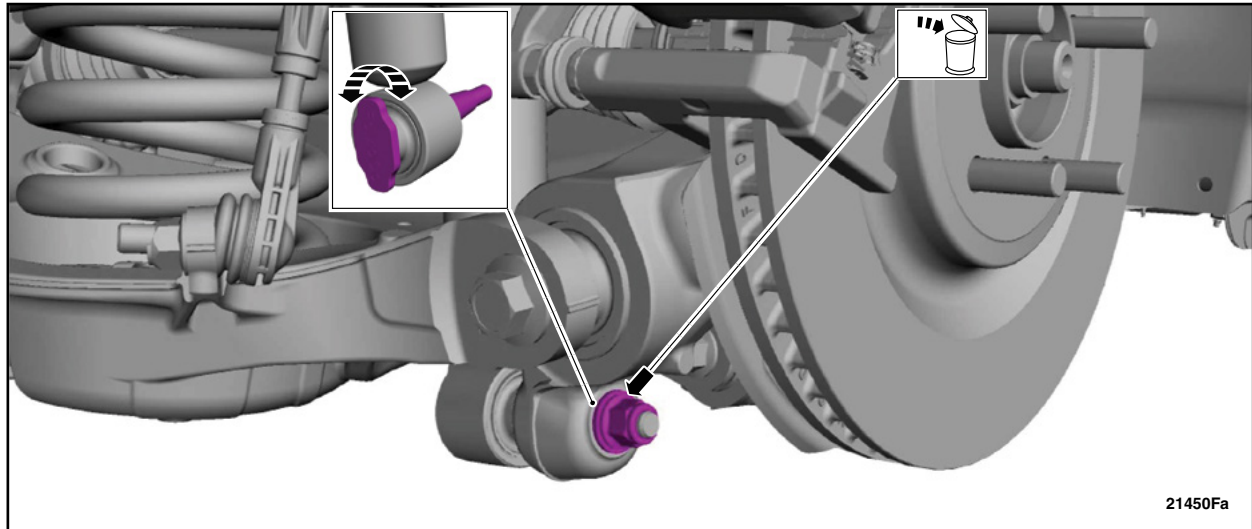

**FIGURE 3**

8. Remove the wheel speed sensor bolt and position the wheel speed sensor aside. Remove the brake hose bracket bolt and position the brake hose bracket aside. See Figure 4.

- Brake hose bracket bolt torque: 15 Nm (133 lb.in).
- Wheel speed sensor bolt torque: 15 Nm (133 lb.in).

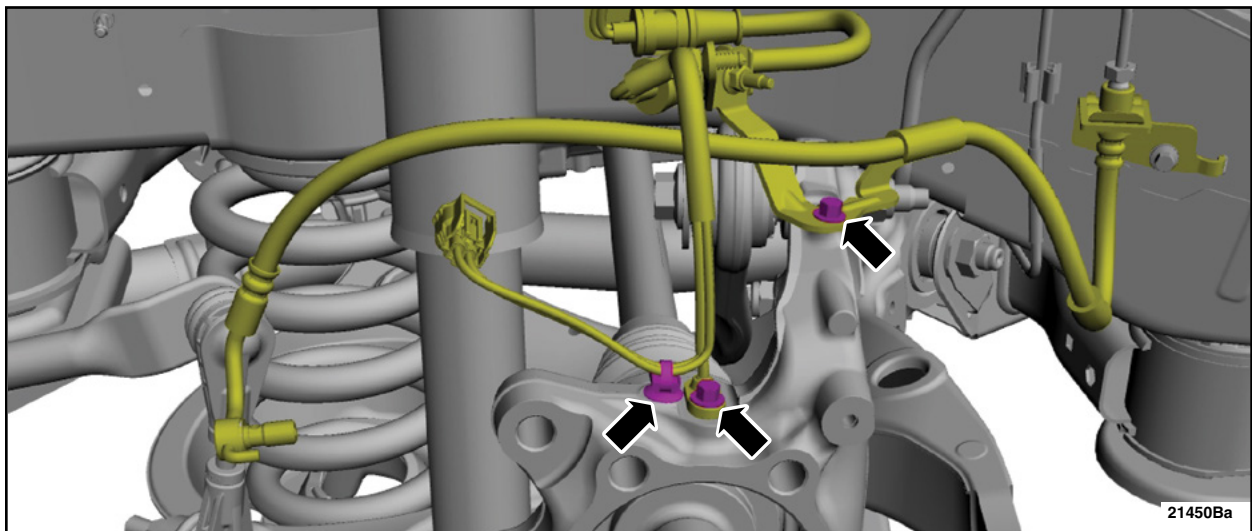

**FIGURE 4**



9. *Remove and discard the lower arm vertical link lower nut. Remove, clean and inspect the lower arm vertical link lower bolt threads. If the threads are not damaged, apply LOCTITE® 263™, or equivalent (Obtain locally), and reuse the bolt and order a new nut. If the threads are damaged order a new nut and bolt. Position the lower arm vertical link bolt aside.* See Figure 5.

• Torque: 350 Nm (258 lb.ft).

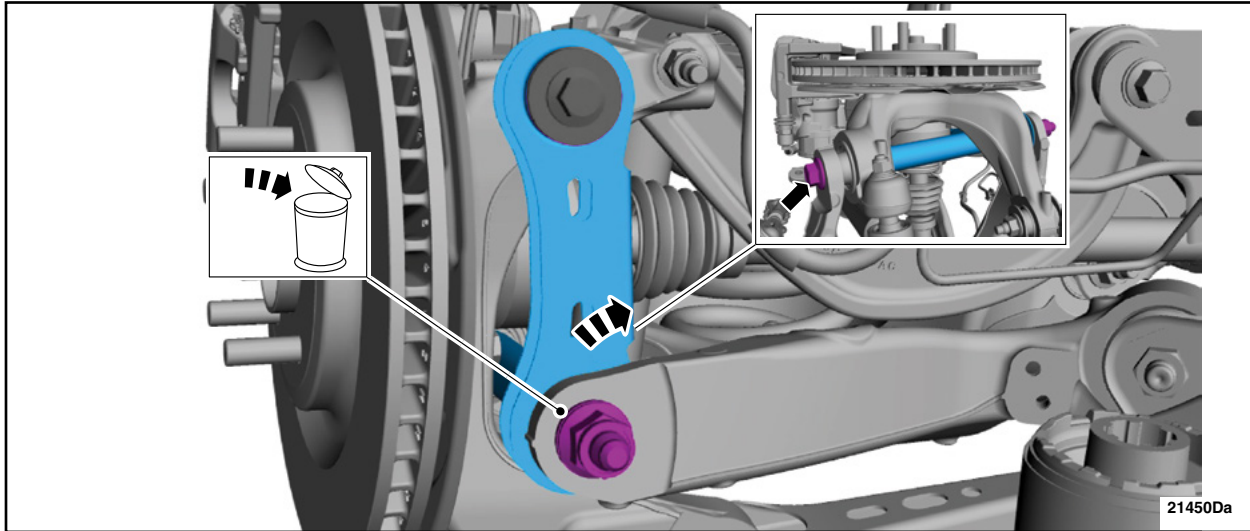

FIGURE 5

10. Remove and discard the toe link-to-wheel knuckle bolt and nut. See Figure 6.

• Torque: 175 Nm (129 lb.ft).

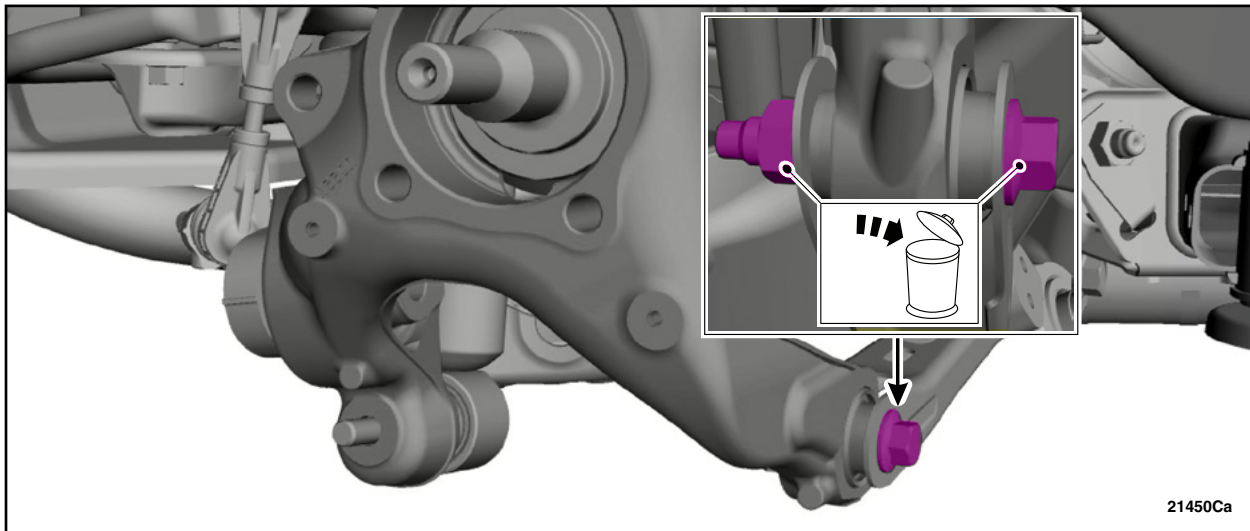

FIGURE 6

11. Position the knuckle up to remove halfshaft from the wheel knuckle.
12. Using a pry bar, remove the Left Hand (LH) halfshaft.





13. Using a pry bar, disengage the Right Hand (RH) halfshaft inner halfshaft circlip. See Figure 7.

**NOTE:** It is not necessary to remove the RH halfshaft from the vehicle.

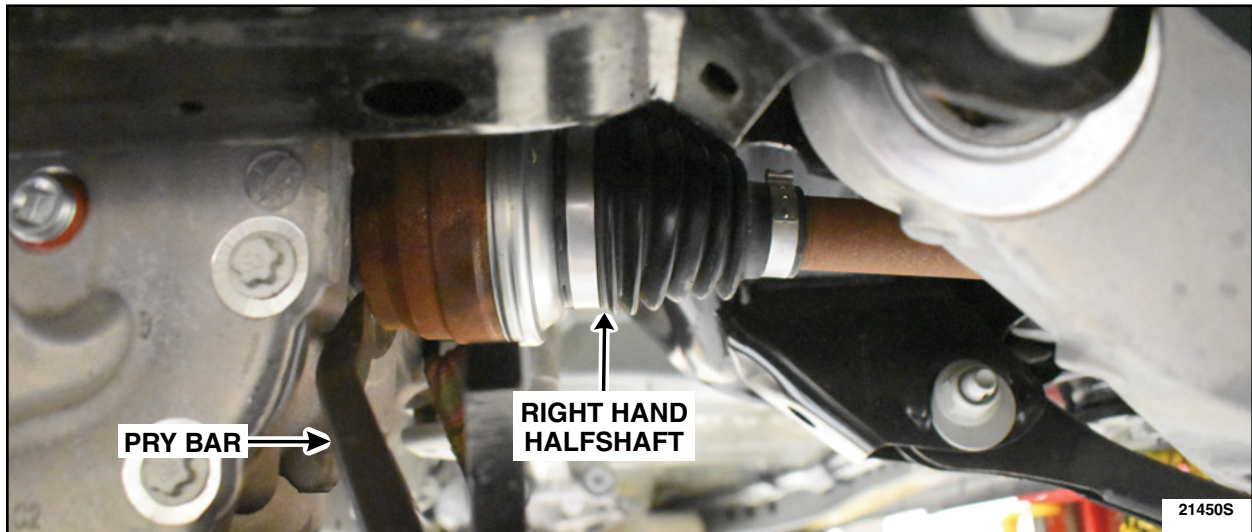

**FIGURE 7**

14. Secure the rear axle assembly to the transmission jack using a ratchet strap. See Figure 8.

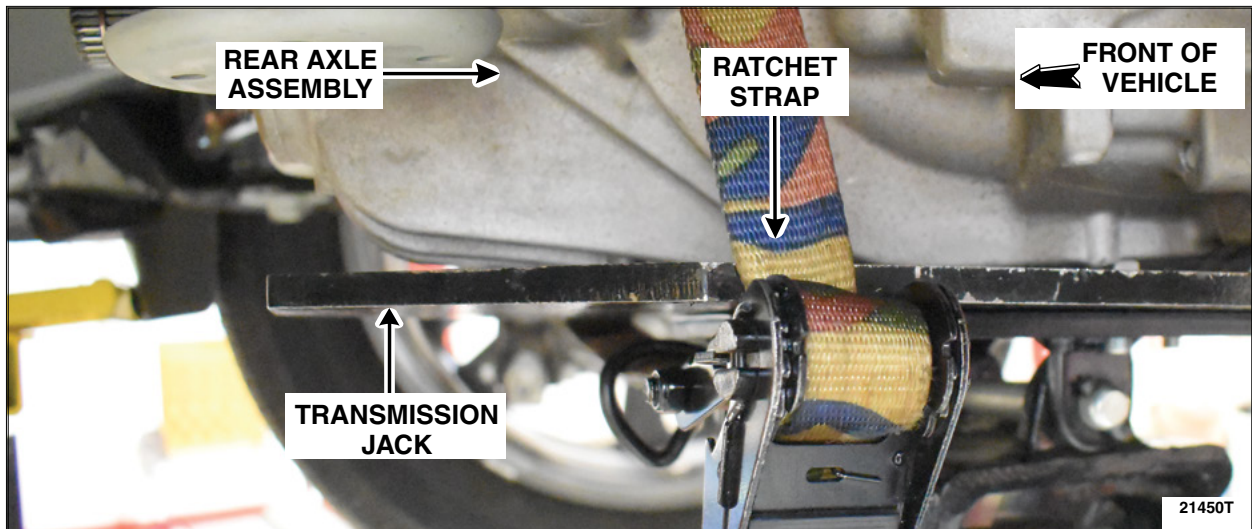

**FIGURE 8**





15. Remove the rear driveshaft. Follow WSM procedures in Section 205-01.

16. Disconnect and position the axle assembly vent hose aside. See Figure 9.

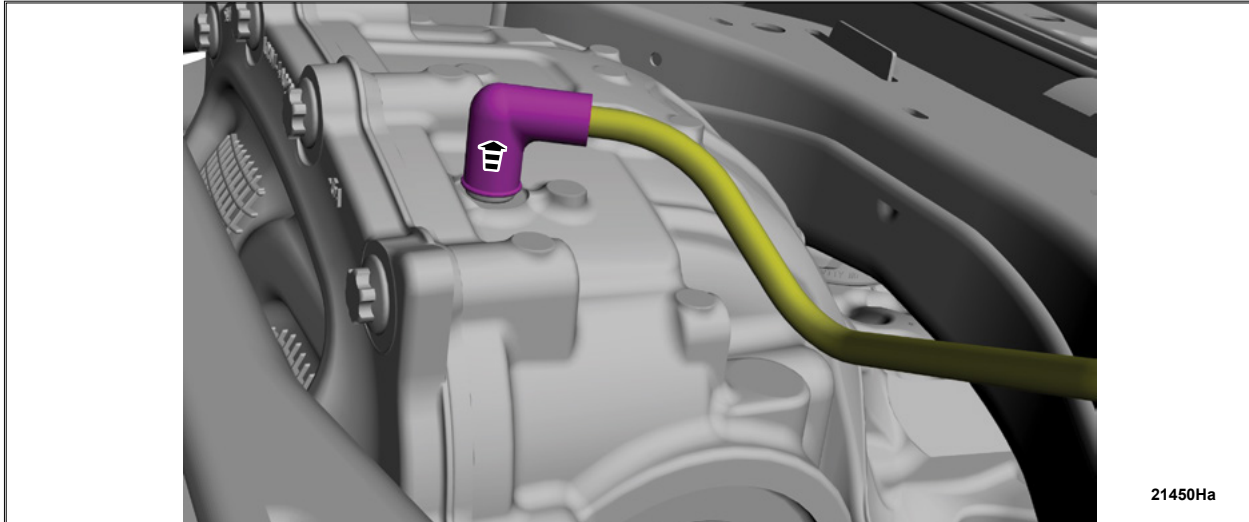
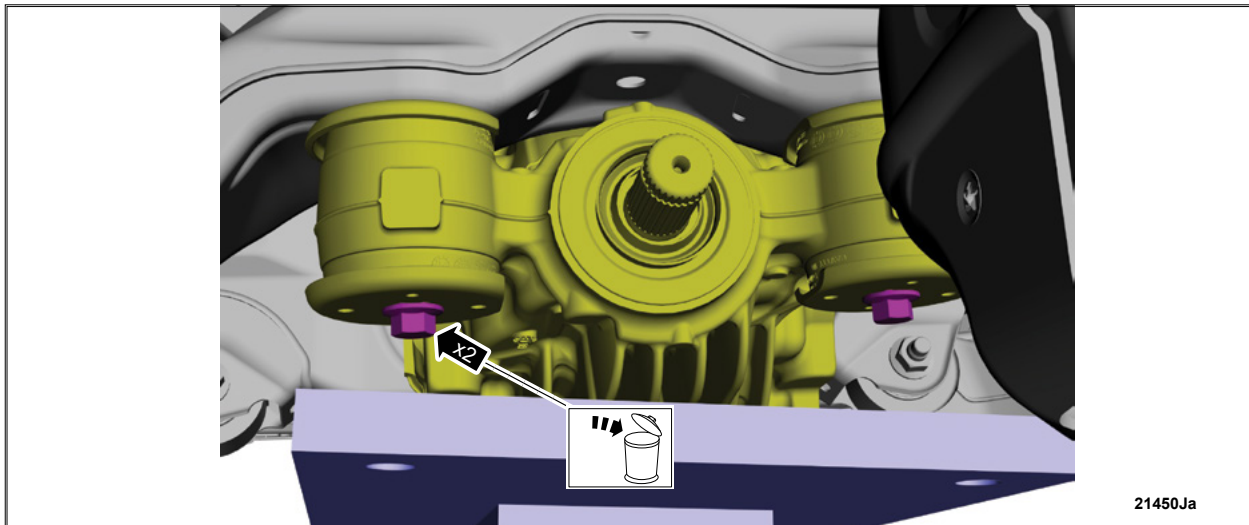

**FIGURE 9**

**NOTE:** In the next Step, clean and inspect both of the rear axle housing support bolt threads. If the threads are not damaged, apply LOCTITE®263™, or equivalent (Obtain locally), and reuse both bolts. If the threads are damaged order new bolt(s).

17. Remove and discard the rear axle housing support front bolts. See Figure 10.

- Torque: 175 Nm (129 lb.ft).



**FIGURE 10**



18. Remove and discard the rear axle housing support rear bolt. See Figure 11.

• *Follow the Torque sequence below:*

*Stage 1: Torque to: 100 Nm (74 lb.ft).*

*Stage 2: Tighten an additional: 100°.*

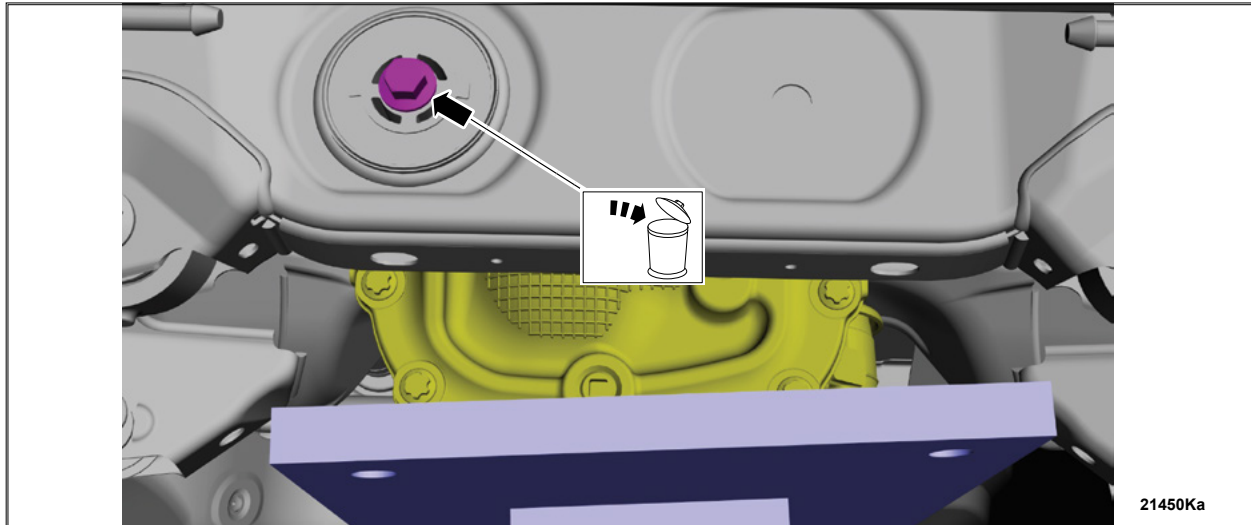

**FIGURE 11**

19. Gently let down the transmission jack and remove the rear axle assembly. See Figure 12.  
Use the General Equipment: Transmission Jack

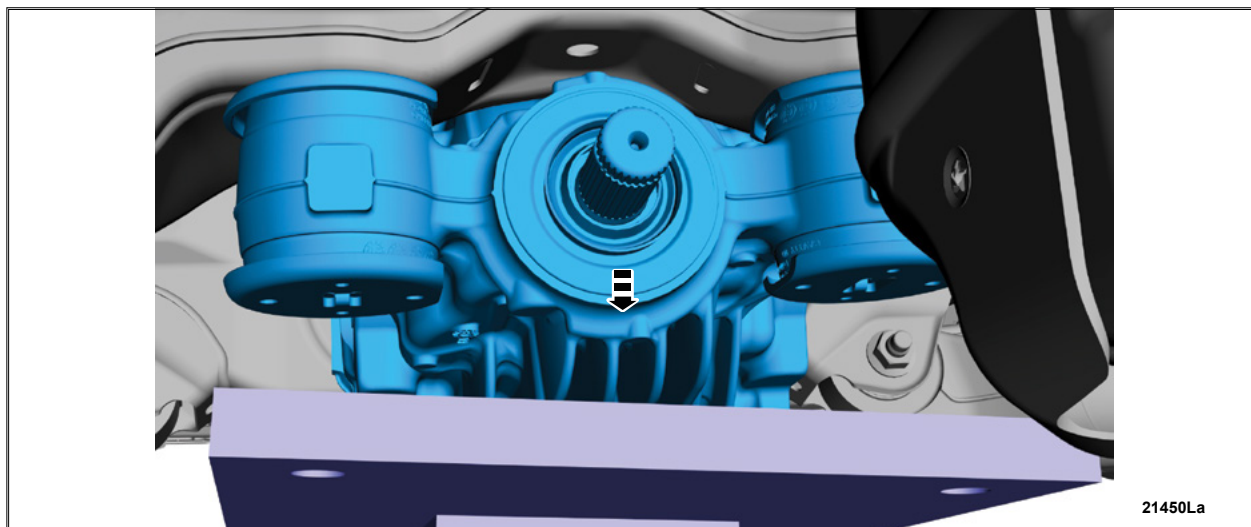

**FIGURE 12**

**NOTE:** Slowly lower the rear axle assembly while positioning it as you are removing the RH halfshaft from the rear axle assembly.



20. Visually inspect the rear differential cover bushing boss for damage (broken fastener, scoring, cracks and/or deformation and damaged threads). Is the rear differential cover bushing boss damaged?  
See Figures 13 and 14.

YES - Does not pass inspection. Install a new differential housing cover. Follow the WSM procedures, in Section 205-02. Proceed to Step 23.

NO - Passes inspection. Proceed to Step 21.

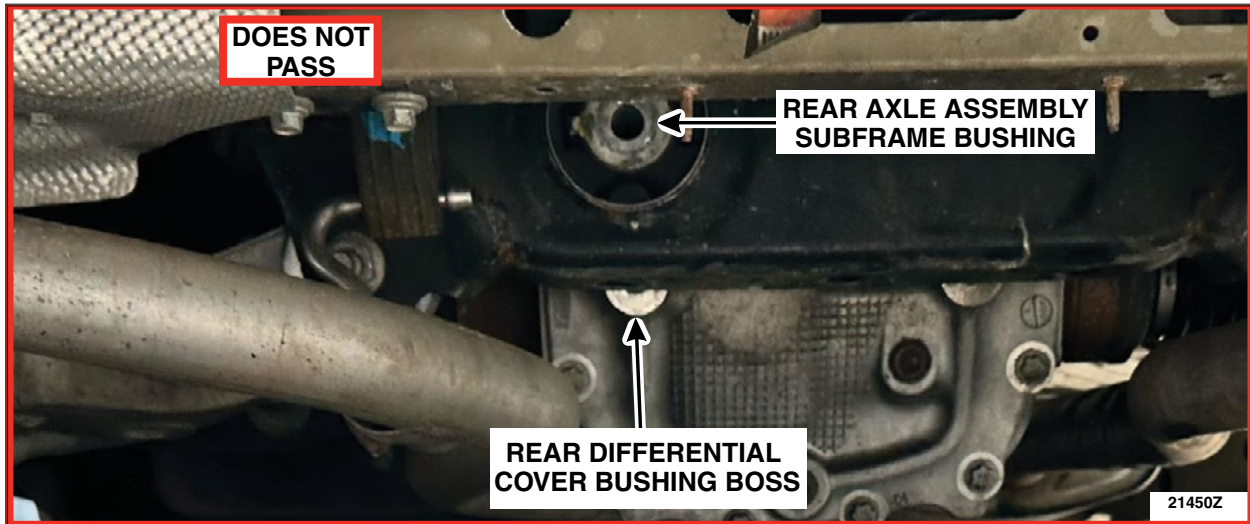

FIGURE 13

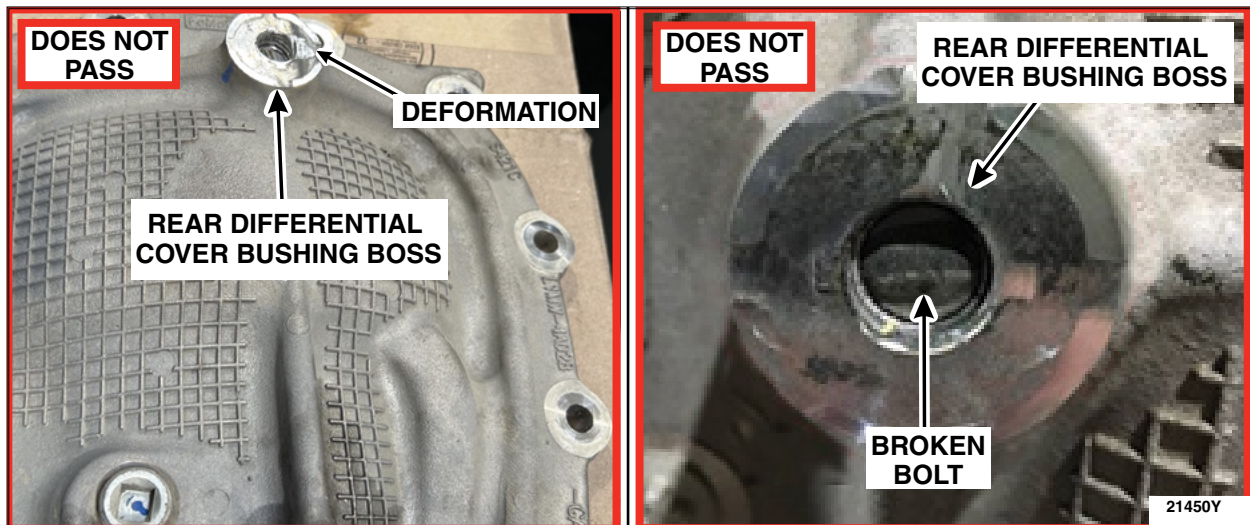

FIGURE 14



21. Using an M14 bolt ensure the threads of the rear differential cover bushing boss are not damaged. Can the M14 bolt be fully threaded in?  
YES - Passes inspection. Proceed to Step 22.  
NO - Does not pass inspection. Install a new differential housing cover. Follow WSM procedures in Section 205-02. Proceed to Step 23.
22. Using a straight edge check to ensure the rear differential cover bushing boss is flat. Is the rear differential cover bushing boss flat?  
YES - Passes inspection. Proceed to Step 23.  
NO - Does not pass inspection. Install a new differential housing cover. Follow WSM procedures in Section 205-02. Proceed to Step 23.
23. Using an 11/16th or larger drill bit drill out the rear axle assembly subframe bushing bolt hole. See Figure 15.

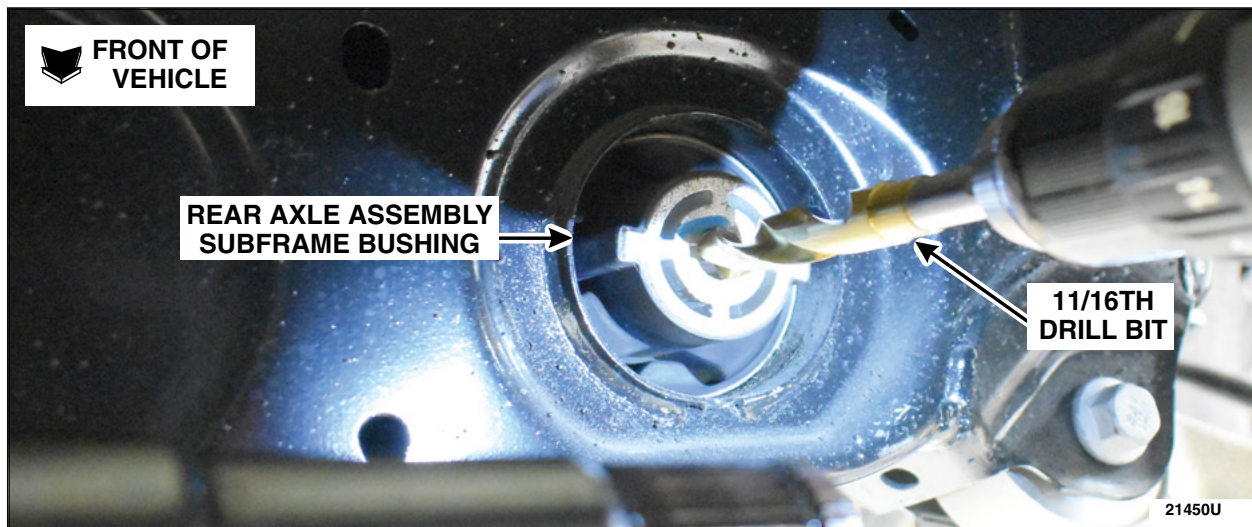

FIGURE 15





24. Using the Special Service Tool: 204-594 Forcing screw, 204-356/1 Remover/Installer, Radius Arm Axle Bushing, 204-356/2 Remover/Installer, Radius Arm Axle Bushing, 307-739 Installer, R3 Bearing, and 205-153 Adapter for 303-224 (Handle) and press out the rear axle assembly subframe bushing. See Figure 16.

**NOTE:** The bearing, 307-739 Installer, R3 Bearing and 204-356/2 Remover/Installer, Radius Arm Axle Bushing go towards the front of the vehicle.

**NOTE:** The rear axle assembly subframe bushing will be pressed out towards the rear of the vehicle.

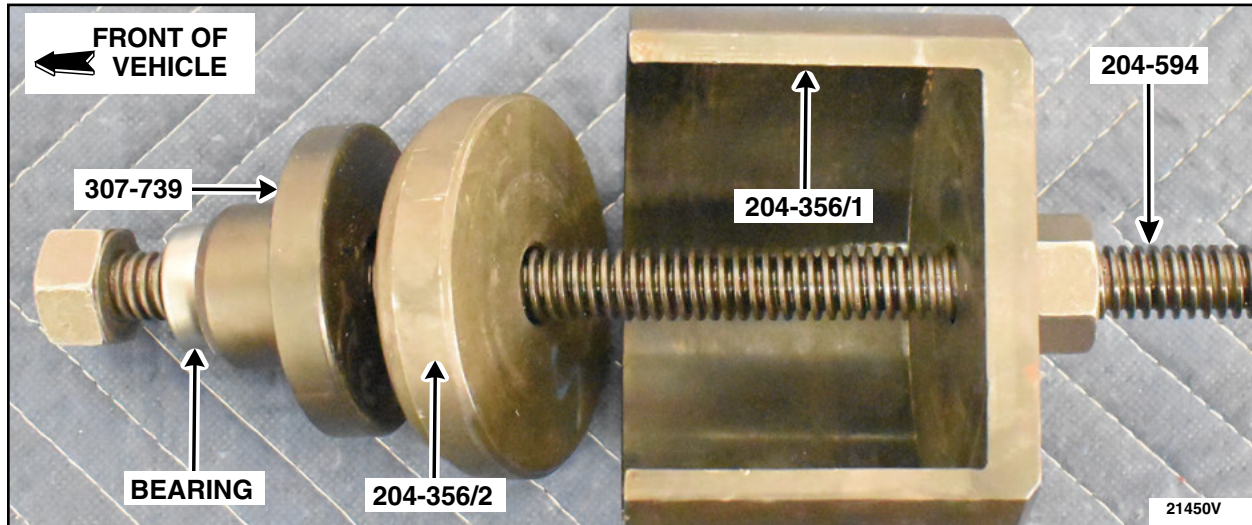

**FIGURE 16**

**NOTE:** Make sure the tabs on the *new* rear axle assembly subframe bushing are horizontal with the subframe. See Figure 17.

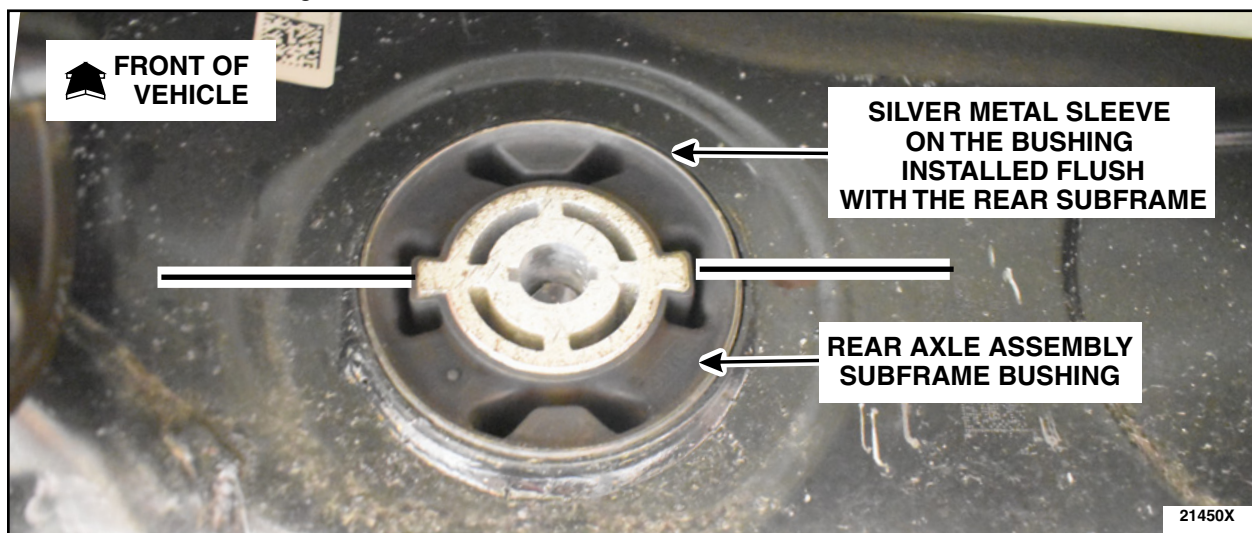

**FIGURE 17**



25. Install the *new* rear axle assembly subframe bushing using the Special Service Tool: 204-594 Forcing screw, 204-362/3 Remover/Installer, Front Subframe Bushing, and 307-819 Cup, Receiver.  
See Figure 18.

**NOTE:** The bearing, and 307-819 Cup, Receiver go towards the front of the vehicle.

**NOTE:** The *new* rear axle assembly subframe bushing will be pressed in from the rear of the vehicle.

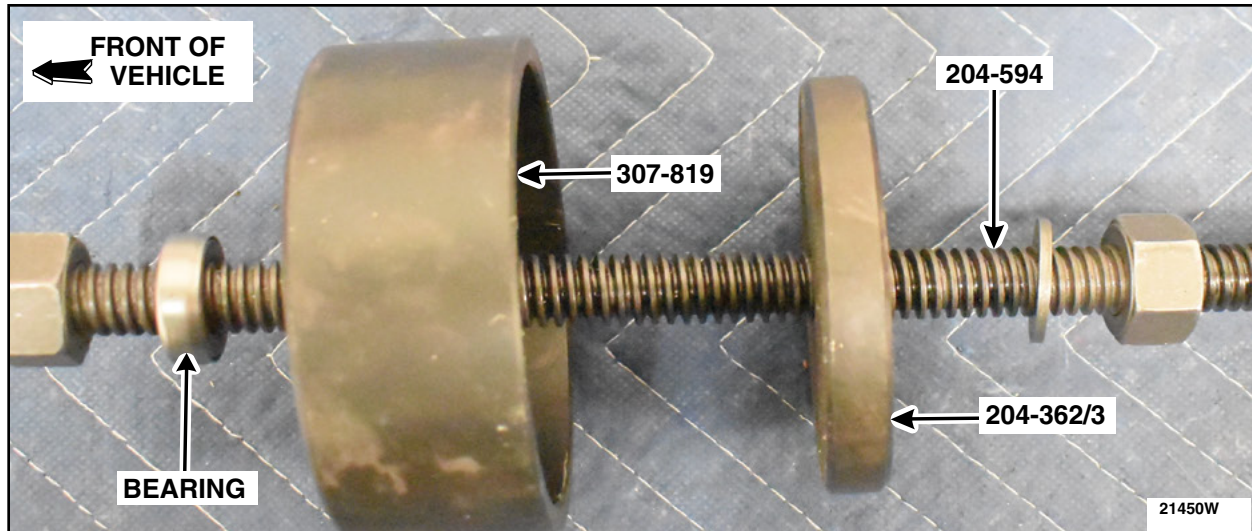

**FIGURE 18**

26. Reverse the removal steps to reinstall the rear differential housing assembly.

27. Using a jack stand set the ride high before torquing any suspension bolts.

**IMPORTANT NOTE:** Federal law prohibits selling motor vehicle parts or components that are under safety, compliance, or emissions recall. Unless a part is requested to be returned to Ford, all parts replaced under this FSA must be scrapped in accordance with all applicable local, state and federal environmental protection and hazardous material regulations. Refer to the Parts Retention, Return, & Scrapping section of the FSA dealer bulletin for further information.



**NEW VEHICLE DEMONSTRATION / DELIVERY HOLD****Safety Recall 22S27**

Certain 2020-2022 Model Year Explorer Vehicles

Rear Axle Bolt Fractures

**Please insert this page in your Owner's Manual.**

As part of Recall 22S27, your vehicle has received a Powertrain Control Module (PCM) update that affects the parking brake function.

Your vehicle will apply the electronic parking brake (EPB) when the vehicle is shifted into park (P). This will occur when the vehicle is commanded to shift to park (P) by the customer, the driver seatbelt is unbuckled and the left front door is opened, or the ignition is turned off. You may notice the parking brake lamp turns on each time park (P) is selected.

To release the EPB automatically, the following criteria need to be met:

- driver door is closed
- vehicle is shifted to reverse (R) or drive (D)
- accelerator pedal is depressed

Alternatively, the EPB can be manually released by the driver using the parking brake switch once the following criteria are met:

- ignition switch is in the "On" or "Accessory" positions
- brake pedal is depressed

**Warning:** Always make sure that the EPB is applied and that you have shifted the vehicle into park (P) before exiting the vehicle. Failure to follow this instruction could result in personal injury or death.

**Inserte esta página en el Manual del propietario.**

Como parte de la Campaña 22S27, su vehículo ha recibido una actualización del módulo de control del tren motriz (PCM) que afecta la función del freno de estacionamiento.

Su vehículo aplicará el freno de estacionamiento electrónico (EPB) cuando cambie a estacionamiento (P). Esto ocurrirá cuando el usuario ordene el cambio a estacionamiento (P), el conductor se desabroche el cinturón de seguridad y se abra la puerta delantera izquierda o se apague el encendido. Podrá observar que la luz del freno de estacionamiento se enciende cada vez que selecciona la posición de estacionamiento (P).

Para liberar automáticamente el EPB, se deben cumplir los siguientes criterios:

- la puerta del conductor está cerrada
- el vehículo se coloca en reversa (R) o manejo (D)
- se presiona el pedal del acelerador

Alternativamente, el conductor puede liberar manualmente el EPB a través del interruptor del freno de estacionamiento, siempre que se cumplan los siguientes criterios:

- el interruptor de encendido está en "Activado" o en "Accesorios"
- se presiona el pedal del freno

**Alerta:** Siempre asegúrese de que el EPB esté aplicado y que haya cambiado a la posición estacionamiento (P) antes de salir del vehículo. Si no se siguen estas instrucciones se podrían producir lesiones personales o la muerte.



NEW VEHICLE DEMONSTRATION / DELIVERY HOLD  
Safety Recall 22S27 - **Supplement # 6**  
Certain 2020-2022 Model Year Explorer Vehicles  
Rear Axle Bolt Fractures

**MOBILE REPAIR / VEHICLE PICK-UP AND DELIVERY  
RECORD**

VIN \_\_\_\_\_ received (check one):

- Mobile Repair
- Pick-up and/or delivery service

As outlined below for the 22S27 Recall program.

Mobile Repair – Date: \_\_\_\_\_

OR

Pick-up – Date: \_\_\_\_\_

Delivery – Date: \_\_\_\_\_

\_\_\_\_\_  
Repair Order #

\_\_\_\_\_  
Repair Order Date

\_\_\_\_\_  
Service Manager Signature

\_\_\_\_\_  
Date

**NEW VEHICLE DEMONSTRATION / DELIVERY HOLD**  
**Safety Recall 22S27 - Supplement # 6**  
Certain 2020-2022 Model Year Explorer Vehicles  
Rear Axle Bolt Fractures













**Mobile Service Repair Assessment**

Assessment levels have been identified to help determine the ease of performing eligible mobile service repairs for a Field Service Action (FSA) outside of the dealership service facility.

**Dealer Bulletin**



Within Attachment I of the dealer bulletin a mobile service repair assessment level(s) will be provided. These assessment levels have been determined using the amount of time, equipment and labor identified to perform the intended service action.

**Assessment Levels**

-  - Mobile Reprogramming
-   - Light Mobile Service
-    - Enhanced Mobile Service
-     - Advanced Mobile Service
-  - Wheel and Tire Mobile Service
-  - Not Mobile Service Eligible

**Description of each level that is used to determine the overall assessment.**

-  – Mobile Reprogramming
  - Module Programming or similar type services
  - Minimum tools maybe required other than an **IDS/FDRS** setup
  - FDRS programming that requires internet connection (wi-fi or mobile hotspot)
  - Make sure vehicle has a charge port to ensure battery voltage is maintained during flashing of the module(s)
  - Repairs not greater than 1 hour in length (including time to wait for programming)

*Note: The location will need a charging station or wall box to maintain the 12-volt battery.*
-   – Light Mobile Service
  - Interior repair procedures that do not require seat, dash, or headliner removal
  - Under hood repairs that do not require large component removal
  - Exterior repairs that do not require large component/panel removal
  - Repairs may require standard hand tools (Access to a Technician starter kit or similar)

**NEW VEHICLE DEMONSTRATION / DELIVERY HOLD**  
**Safety Recall 22S27 - Supplement # 6**  
Certain 2020-2022 Model Year Explorer Vehicles  
Rear Axle Bolt Fractures

   – Enhanced Mobile Service

- **A two-person process is required anytime a procedure requires work under the vehicle**
  - Brake Inspection and Brake Repair/Replacement
  - Limited Suspension Component replacement (no alignment)
  - Under Vehicle access for limited repairs (no large component removal)
  - Vehicle Check Up - VCU
  - Pre-Delivery Inspection - PDI
  - Used Car Inspection/Presale Inspection
  - May require floor jack, jack stands, and impact tools
- Note: Wheel lock may be required.*

    – Advanced Mobile Service

- Fluid Exchange/Oil Change
- Light Repairs
- Brake Hydraulic Repairs

 – Wheel and Tire Mobile Service

- Tire Removal from Wheel
- Tire Balancing
- Tire Repair

*Note: Specialized Mobile Service unit and equipment including Tire balancer and Tire Changer required.*

 – Not Mobile Service Repair Eligible

- Large component removal
- BEV Battery Replacement
- Requires a vehicle hoist – to complete the repair (more than inspection)
- Required vehicle alignment
- Requires significant vehicle disassembly
- Repairs greater than 2-3 hours
- Any repairs that require M-Time
- Includes a service procedure where the vehicle owner may be distressed about the state of their vehicle

**Ford Motor Company**  
**Recall Reimbursement Plan for 22S27**

*Ford and Lincoln dealers are in the best position to quickly and efficiently process reimbursement requests. However, federal legislation requires all motor vehicle manufacturers to establish processes through which customers may seek recall reimbursement directly from the manufacturer or from the dealers.*

*Regarding the specific reimbursement plan for Recall # 22S27, owners who have paid for service to remedy the defect or noncompliance must have had that service performed prior to June 24, 2022. After this date, if repairs related to this recall are performed by a non-Ford repair facility in an emergency situation, customers must submit any refund requests through their dealership. As required by this federal regulation, Ford Motor Company submitted the details of its latest General Recall Reimbursement Plan in a letter to the National Highway Traffic Safety Administration (NHTSA) in May 2021. The following is the text of that letter and the Plan:*

**General Recall Reimbursement Plan**  
(As submitted to the NHTSA)

Pursuant to the requirements set forth in 49 CFR Part 573 and Part 577 of the Code of Federal Regulations, Ford Motor Company (Ford) is submitting required information pertaining to our general reimbursement plan for the cost of remedies paid for by vehicle owners before they are notified of a related safety recall.

Set forth below is Ford's general plan to reimburse owners and purchasers for costs incurred for remedies in advance of notification of potential safety-related defects or noncompliances pursuant to Part 573.6 (c)(8)(i). This plan has not changed since our February 20, 2019 submission.

**Reimbursement Notification**

Ford's notice to a vehicle owner in accordance with 49 CFR Part 577 will indicate that Ford is offering a refund if the owner paid to have service to remedy the defect or noncompliance prior to a specified ending date. In accordance with Part 573.13 (c)(2), this ending date will be defined as a minimum of ten calendar days after the date on which Ford mailed the last of its Part 577 notifications to owners, and will be indicated in the specific reimbursement plan available to owners for an individual recall. This notice will direct owners to seek eligible reimbursement through authorized dealers or, at their option, directly through Ford at the following address:

Ford Motor Company  
P.O. Box 6251  
Dearborn, MI 48121-6251

Ford notes that this rule allows for the identification of a beginning date for reimbursement eligibility. Under the rule, an owner who paid to remedy the defect or noncompliance prior to the identified beginning date would not be eligible for reimbursement. Ford generally has not established such a beginning date for reimbursement eligibility and does not presently anticipate changing this general policy. However, in any case where Ford determines a beginning date is appropriate, Ford will indicate that date in the owner notice. As permitted by 577.11(e), Ford may not include a reimbursement notification when all vehicles are well within the warranty period, subject to approval by the agency.

## **Costs to be Reimbursed**

For vehicles, reimbursement will not be less than the lesser of:

- The amount paid by the owner for the remedy that specifically addressed and was reasonably necessary to correct the defect or noncompliance that is the subject of the recall, or
- The cost of parts for the remedy (to be no more than the manufacturer's list retail price for authorized part(s), plus associated labor at local labor rates, miscellaneous fees (such as disposal of waste) and taxes.

For replacement equipment, reimbursement will be the amount paid by the owner for the replacement item (limited by the amount of the retail list price of the defective or noncompliant item that was replaced, plus taxes, where the brand or model purchased by the owner was different than the brand or model that was the subject of the recall). If the item of motor vehicle equipment was repaired, the reimbursement provisions identified above for vehicles will apply.

Ford notes that costs incurred by the owner within the period during which Ford's original or extended warranty would have provided for a free repair of the problem will not be eligible for reimbursement, as provided by Part 573.13 (d)(1).

### Entities Authorized to Provide Reimbursement

Ford will continue to use authorized dealers to reimburse owners under the specific reimbursement plans for a particular recall, and will encourage owners to pursue requests for reimbursement directly through dealers to expedite reimbursement. Ford will also provide a mailing address to which customers can, at their option, send requests for reimbursement directly to Ford, as previously noted. Requests for reimbursement sent directly to Ford may take up to 60 days to process. Whether the owner chooses to pursue reimbursement requests through a dealer or directly through Ford, the owner will be directed to submit the required documentation, upon which reimbursement eligibility will be determined.

### **Required Documentation**

The reimbursement determination will depend upon the information provided by the customer. Consistent with Part 573.13 (d)(4) the following information must be submitted:

- Claimant name and address
- Vehicle make, model, and model year
- Vehicle identification number (VIN) and, for replacement equipment, a description of such equipment or, for tires, the model, size and TIN (DOT code)
- Identification of the recall number (either the Ford recall number or the NHTSA recall number)
- Identification of the owner of the recalled vehicle at the time that the pre-notification remedy was obtained
- An original receipt for the pre-notification remedy that includes a breakdown of the amount for parts, labor, other costs and taxes, including costs for the replacement item. Where the receipt covers work other than to address the recall or noncompliance, Ford may require the claimant to separately identify costs that are eligible for reimbursement.
- If the remedy was obtained during the warranty period, documentation indicating that the warranty was not honored or the warranty repair did not correct the problem related to the recall.

Failure to submit all of the above information may result in denial of the reimbursement request.

## **Additional Information**

The Part 577 required owner notice will provide a toll-free telephone number through which specific information about the reimbursement plan can be requested from Ford. This general reimbursement plan will be incorporated into notifications pursuant to Part 573.6 by reference. Information specific to an individual recall also may be incorporated into the Part 573.6 notification.