



CR214 – Rear Brake Hose Replacement

Monster 821 Model Year 2018-2020 (USA-CAN only)
Safety Recall Campaign SRV-RCL-21-007

Date: June 30, 2021
To: Dealer Principal, General Manager, Service Manager, North American Dealer Network
From: Richard Kenton, Technical Director
Eric Bradley, Technical Training and Publications Manager

Dear Dealers,

Ongoing product quality testing and field reports have identified a potential for the rear brake application to soften over time as a consequence of use. To correct in cases of this occurrence, new rear brake hoses (rear brake master cylinder to ABS control unit – yellow, and ABS control unit to rear brake caliper – blue) must be replaced for the above listed models.

To carry out the intervention it is necessary to order as a spare part the kit part no. 69929491A dedicated to Monster 821 MY 18-20, consisting of the components in the table below.

Kit part no.	Components	Quantity
69929491A	Rear brake master cylinder - ABS control unit hose	1
	ABS control unit - rear brake caliper hose	1
	Heat guard	1
	Heat reflective material for heat guard	1
	Hose grommet on vertical head	1

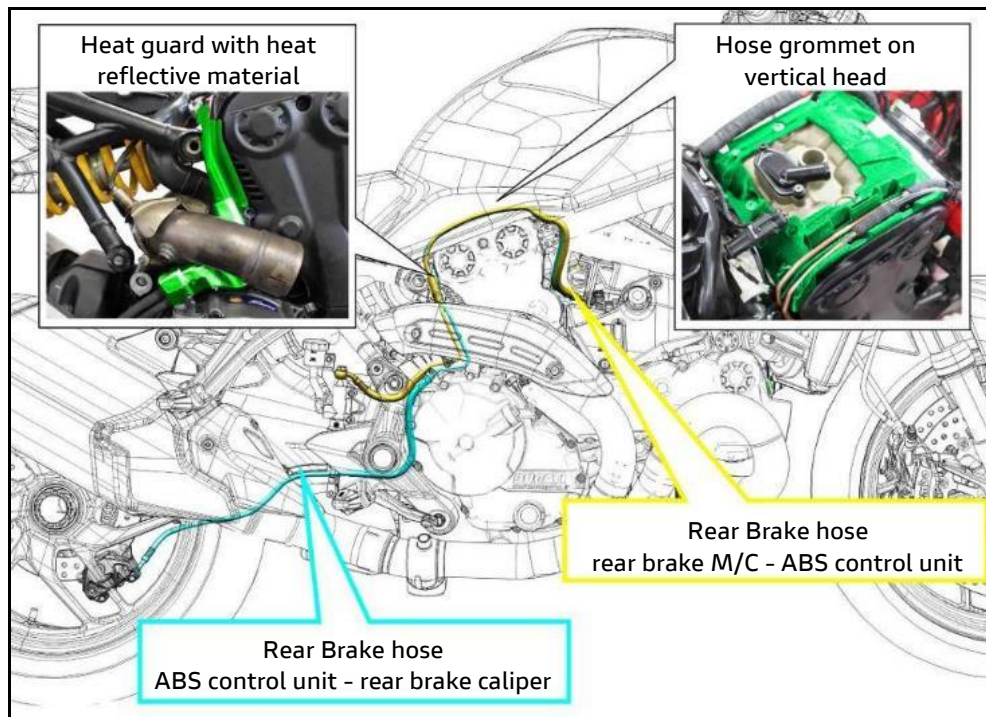



CR214 – Rear Brake Hose Replacement

Monster 821 Model Year 2018-2020 (USA-CAN only)
Safety Recall Campaign SRV-RCL-21-007

Application

You can find the precise list of VIN numbers involved in CR214 on the DCS, in sections:

VIN HISTORY		It is possible to search by individual frame number.
CAMPAIGNS		It is possible to search for all the frame numbers that you received from Ducati Motor Holding.

MONSTER 821 RED 2020 CAL DMH			
VIN #	ZDMMACLS9LB00 XXX	ENGINE #	ACLL0 XXX
END CUSTOMER	Corsa Moto Transport, Inc.	MANUFACT DATE	02/21/2020
WARRANTY TYPE	STANDARD WTY START DATE	LAST MILEAGE OPERATION	0 MI
SERVICE STATUS			

ATTENTION: YOU HAVE 1 PENDING RECALL CAMPAIGNS

N	TYPE	ID NUMBER	REPAIR DATE	DEFECT	CAUSAL PART	DEALER	MILEAGE
1	RECALL	CR214		SRV-RCL-21-007 Replace Rear Brake Hose	Rear Brake Hose	<input type="button" value="VIEW"/> <input type="button" value="APPLY"/>	

Customer Impact

All motorcycles in your inventory (to be registered or already registered) and to be delivered to final Customers must be updated during pre-delivery operations and always before delivery to the final Customer. All motorcycles already delivered to final Customers must undergo this inspection as soon as they come to your workshop.

Parts Distribution

The following components required to carry out the upgrade under this Safety Recall Campaign must be ordered for each affected frame number.

- 69929491A: Rear brake hoses KIT Monster 821 MY18-21 (1502)
- 85250241A: Copper washers (8pcs)

The required self-locking ties (small and large) are easy to find consumables and should be sourced locally.



WARNING

The Kit part no. 69929491A is NOT currently available. The kit will be available for order in August 2021. A notification will be sent to both the dealers and the affected vehicle owners once the in-stock date is confirmed.



CR214 – Rear Brake Hose Replacement

Monster 821 Model Year 2018-2020 (USA-CAN only)
Safety Recall Campaign SRV-RCL-21-007

Warranty Reimbursement Rules

Reimbursement for work associated with this Safety Recall Campaign will be made through the regular warranty claim procedure using the “**Vehicle History**” section of the DCS. The warranty claim is pre-filled and is identified as CR214.

The dealer will be reimbursed for the parts listed for the operation; copper washers (8) part no. 85250241A, Rear brake hoses KIT Monster 821 MY18-21 Part no. 69929491A, the consumable ties and DOT 4 brake fluid; and labor for **4h:00min** (40 labor units) that includes the time necessary for:

- Vehicle reception
- Rear brake hose removal (ABS control unit / brake M/C and ABS unit / brake caliper)
- Installation of new rear brake hose assembly (ABS control unit / brake M/C and ABS control unit / brake caliper) and new heat guard and hose grommet on vertical head
- Filling and bleeding procedure of the rear brake system
- Soft cleaning of the vehicle

Table of contents







	Page
Introduction	1
Application	2
Customer Impact	2
Parts Distribution	3
Warranty Reimbursement Rules	3
Spare Parts	4
Service Solution – Rear Brake Hose Replacement	5
Part 1: Vehicle Preparation	5
Part 2: Rear Brake Hoses Removal	15
Part 3: Rear Brake Hoses Installation	20
Part 4: Rear Brake System Filling and Bleeding	28
Part 5: Vehicle Refitting and Heat Guard Installation	29
Additional Requirements and Notes	41
Customer Letter Example	42



CR214 – Rear Brake Hose Replacement

Monster 821 Model Year 2018-2020 (USA-CAN only)
Safety Recall Campaign SRV-RCL-21-007

Spare Parts

Part No.	Sub Part No.	Description	Picture	Qty (pcs)
69929491A		Rear brake master cylinder - ABS control unit hose		1
		ABS control unit - rear brake caliper hose		1
		Heat guard		1
		Heat reflective material for heat guard		1
		Hose grommet on vertical head		1
85250241A		Copper washers		8



NOTE

Sub-part numbers are provided for your information in case of damaged or missing items in shipping. Only the Kit part no. 69929491A and Washers (8) part no. 85250241A should be ordered for this operation. Do NOT order the individual kit items for this operation.



WARNING

The Kit part no. 69929491A is NOT currently available. The kit will be available for order in August 2021. A notification will be sent to both the dealers and the affected vehicle owners once the in-stock date is confirmed.



CR214 – Rear Brake Hose Replacement

Monster 821 Model Year 2018-2020 (USA-CAN only)
Safety Recall Campaign SRV-RCL-21-007

Service Solution



WARNING

To ensure the correct execution of the operation within the provided labor time to carry out the updates, it is necessary to follow the sequence indicated in the following instructions

Part 1: Vehicle Preparation

1. Position the bike on the rear paddock stand.
2. Drain all the oil contained inside the rear brake system.



WARNING

Brake fluid may damage the paint or parts of the motorcycle. Wash the affected area with plenty of water in case of accidental contact. Damage due to brake fluid spillage is not a warrantable defect and is the responsibility of the repairing dealer to correct

3. Remove the seat.
4. Remove the fuel tank (See Sec.8: "Fuel/exhaust system – Fuel tank" of the Workshop Manual).
5. Working on the LH side, remove **screw M5x10 (1)** retaining **cover (2)** and pull it up to remove it.
6. Working on the RH side, remove **2 screws M5x9 (3)** and **screw M6x22 (4)** with relevant **spacer (5)** retaining coolant reservoir **cover (6)** and pull it out.

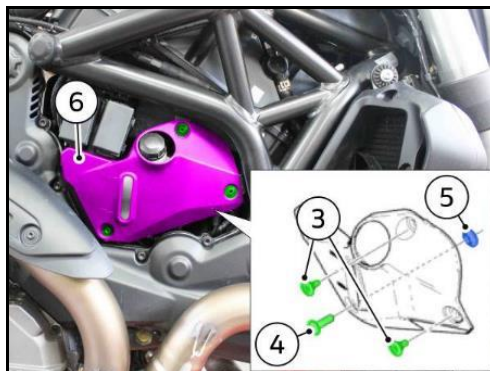
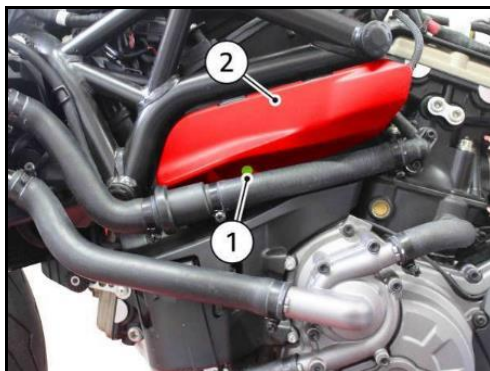



CR214 – Rear Brake Hose Replacement

Monster 821 Model Year 2018-2020 (USA-CAN only)
Safety Recall Campaign SRV-RCL-21-007

Loosen **clamp (7)** and pull out crank case breather **(8)** from the Airbox.

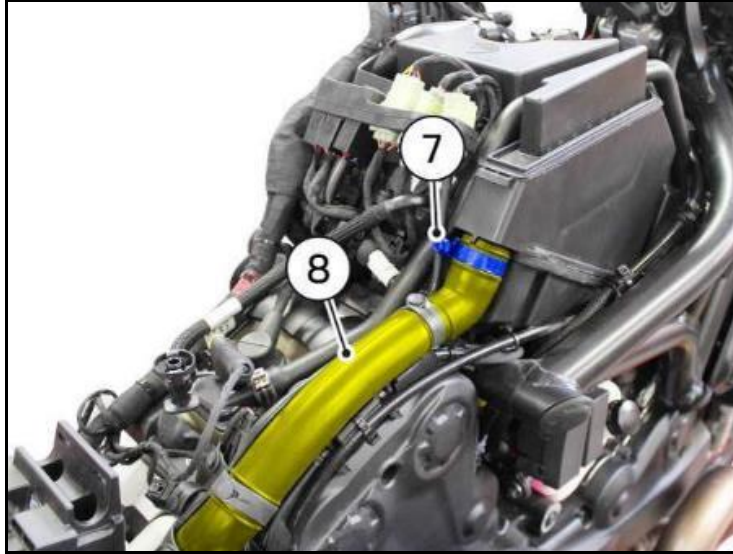

7. Disconnect injector-wiring **connector (9)**, vertical lambda sensor **connector (10)**, potentiometer wiring **connector (11)** and pull out starter **relay (12)**, injection **relay (13)** and fuel pump **relay (14)**.
8. Remove the 2 large self-locking ties **(15)**.

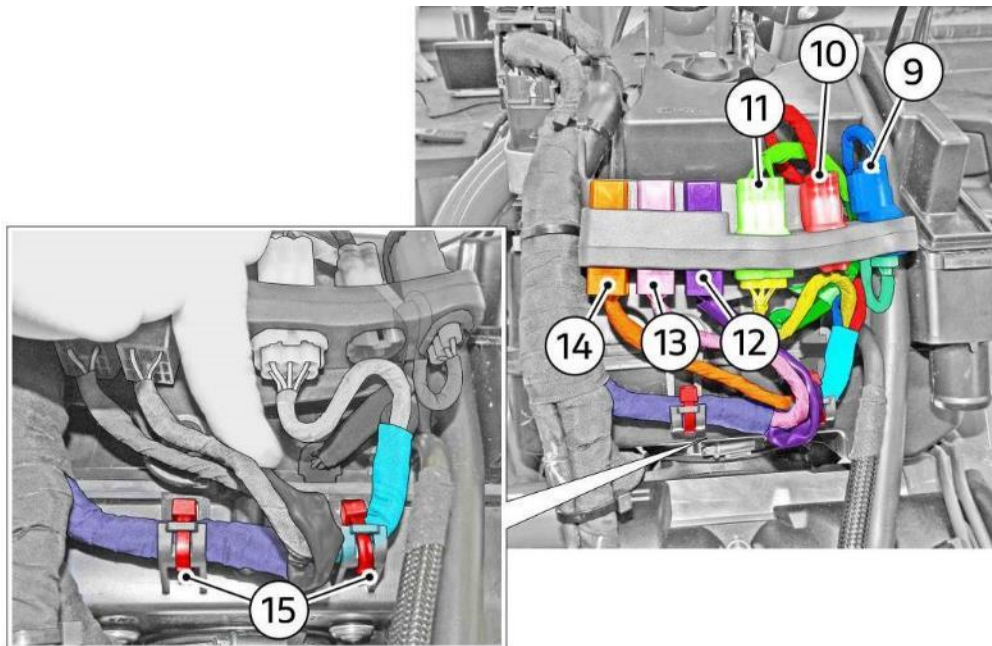



CR214 – Rear Brake Hose Replacement Monster 821 Model Year 2018-2020 (USA-CAN only) Safety Recall Campaign SRV-RCL-21-007

9. Working on vehicle RH side:

- 9 A. Remove the 2 click clamps (16) and pull out the horizontal head secondary air hose (17) and the vertical head secondary air hose (18).
- 9 B. Disconnect secondary air (AIS) connector (19).

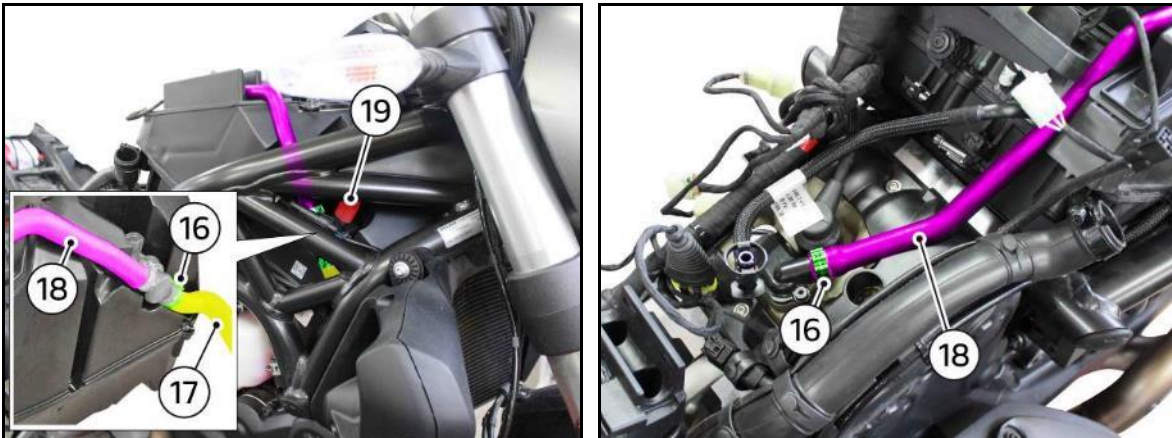

10. Working on vehicle LH side:

- 10 A. Disconnect the 2 connectors (20) of the engine ECU.
- 10 B. Remove the 4 large self-locking ties (21).

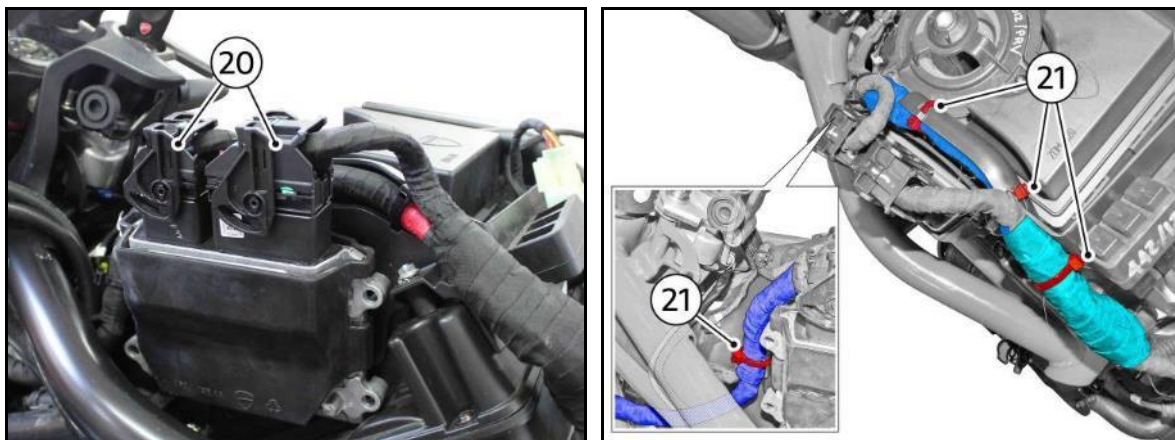



CR214 – Rear Brake Hose Replacement

Monster 821 Model Year 2018-2020 (USA-CAN only)
Safety Recall Campaign SRV-RCL-21-007

- 10 C. Remove the 3 small self-locking ties (22).
- 10 D. Disconnect the air temperature sensor connector (23).
- 10 E. Pull out ignition switch connector (24) from the relevant tab present on the Airbox.

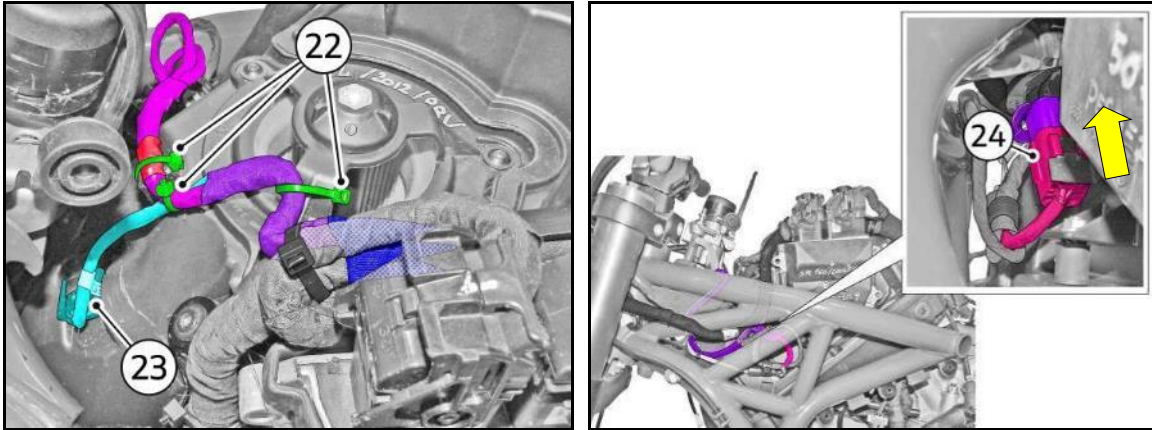

- 10 F. Remove click clamp (25) and pull out Airbox drain hose (26).
- 10 G. Remove 3 screws M5x20 (27) with relevant spacers (28) retaining coil support bracket to access the map sensor connector.

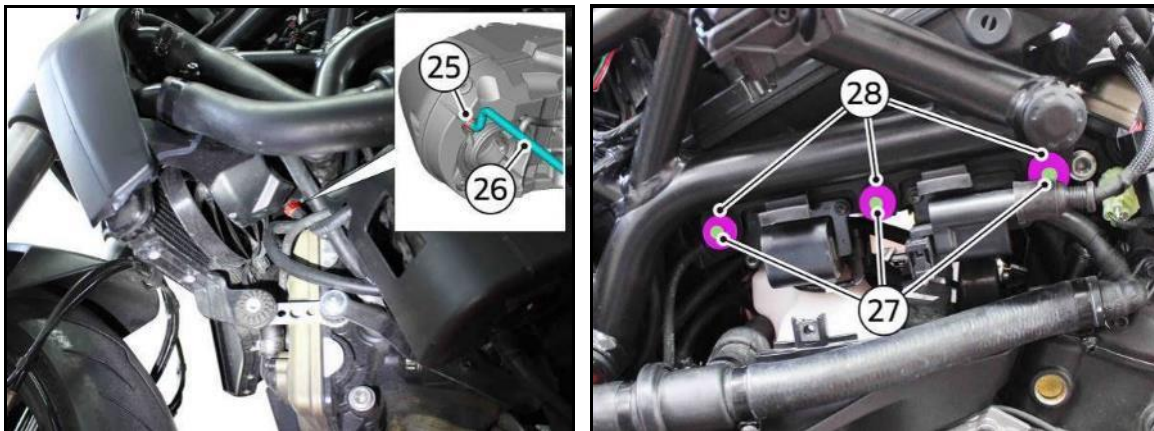



CR214 – Rear Brake Hose Replacement Monster 821 Model Year 2018-2020 (USA-CAN only) Safety Recall Campaign SRV-RCL-21-007

- 10 H. Pull out the horizontal head pressure sensor **hose (29)** and the vertical head pressure sensor **hose (30)** by removing the 2 **ties (31)**.
- 10 I. Disconnect the map sensor **connector (32)**.

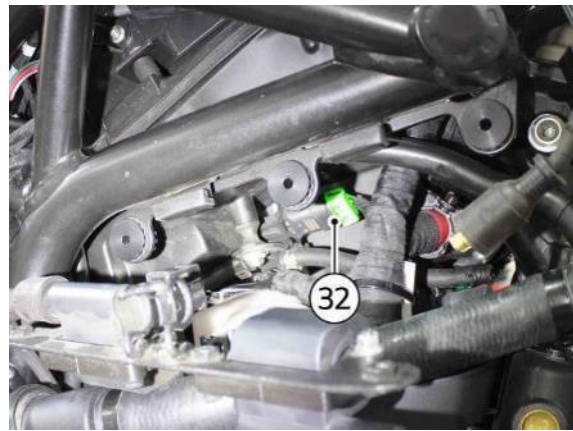
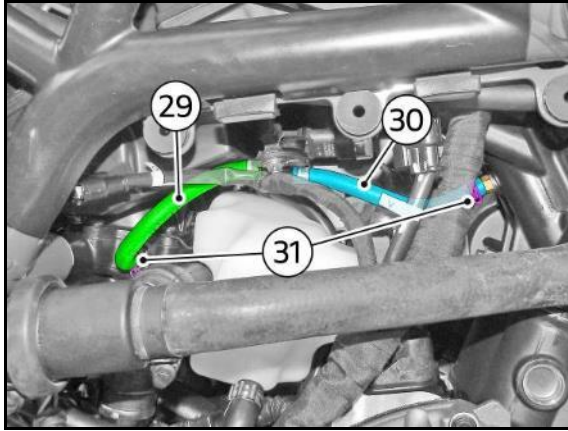

11. Working on vehicle RH side, loosen **clamp (33)** positioned on the vertical cylinder head, while on the LH side, loosen **clamp (34)** positioned on the horizontal cylinder head.
12. Remove the Airbox from the vehicle.

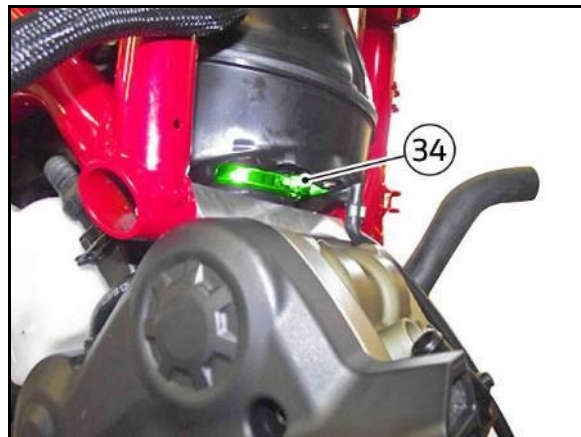



CR214 – Rear Brake Hose Replacement Monster 821 Model Year 2018-2020 (USA-CAN only) Safety Recall Campaign SRV-RCL-21-007

13. Protect the engine with a cloth near the ABS control unit, and cover the intake manifolds as shown in the figure to avoid the possible penetration of brake fluid or impurities inside the manifolds.



WARNING

Brake fluid may damage the paint or parts of the motorcycle. Wash the affected area with plenty of water in case of accidental contact. Damage to finish and components due to brake fluid contact is not covered by warranty and is the responsibility of the dealer to repair

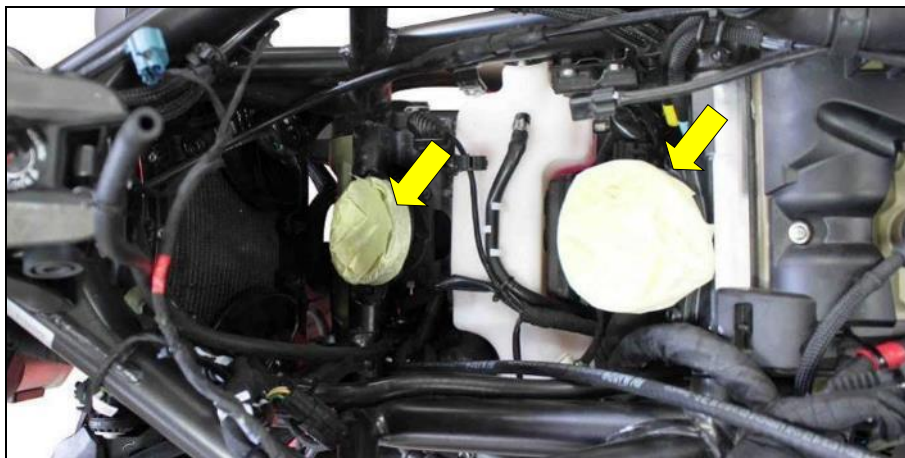

14. Remove the silencer (See Sec.8: "Fuel/exhaust system – Exhaust system" of the Workshop Manual 2.0).
15. Remove the vertical head exhaust manifold (See Sec.8: "Fuel/exhaust system – Exhaust system" of the Workshop Manual 2.0).

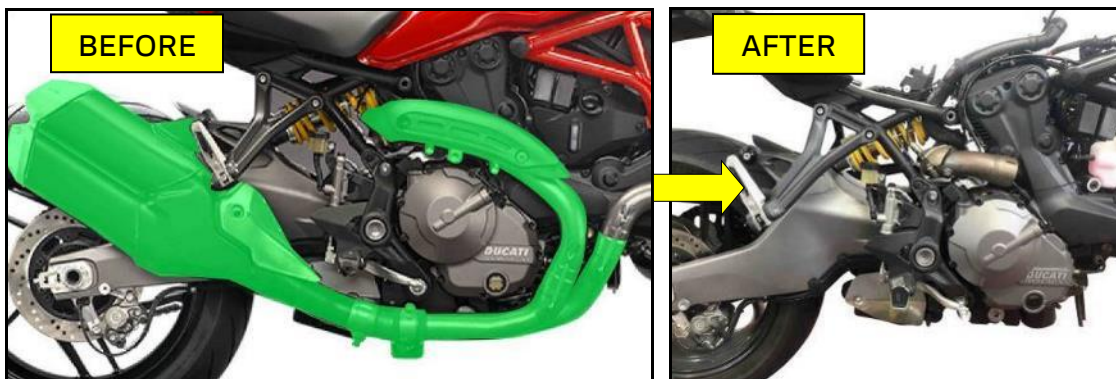



CR214 – Rear Brake Hose Replacement Monster 821 Model Year 2018-2020 (USA-CAN only) Safety Recall Campaign SRV-RCL-21-007

16. Remove the special screw (35) with the 2 copper washers (36) securing brake hose (37) to rear brake master cylinder

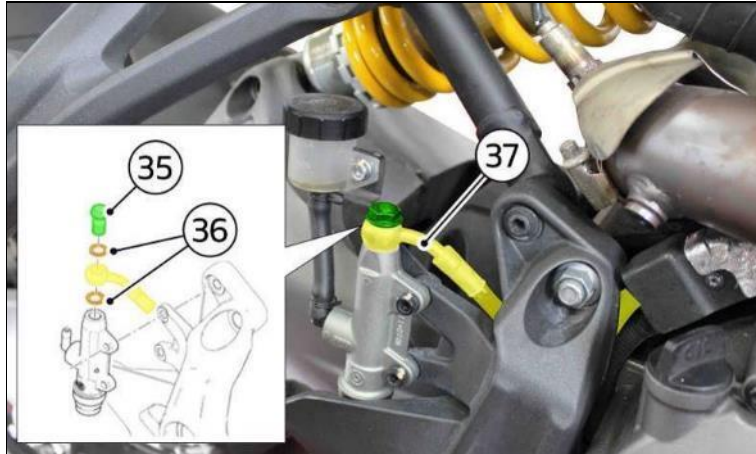

17. To pull out the RH front footpeg holder plate (38) assembly remove:

- the special screw (39) while holding nut M8 (40)
- the nut (41) while holding it on the opposite side
- the special screw (42)
- the screw M10x50 (43)

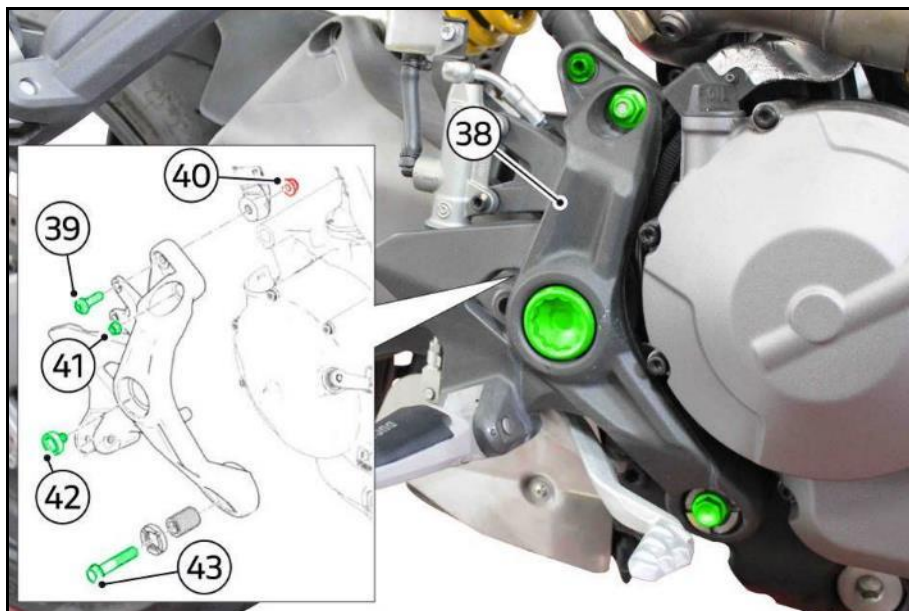



CR214 – Rear Brake Hose Replacement Monster 821 Model Year 2018-2020 (USA-CAN only) Safety Recall Campaign SRV-RCL-21-007

18. Pull out the RH front footpeg holder **plate (38)** by removing self-locking **tie (44)** and disconnect rear stop light **connector (45)**.

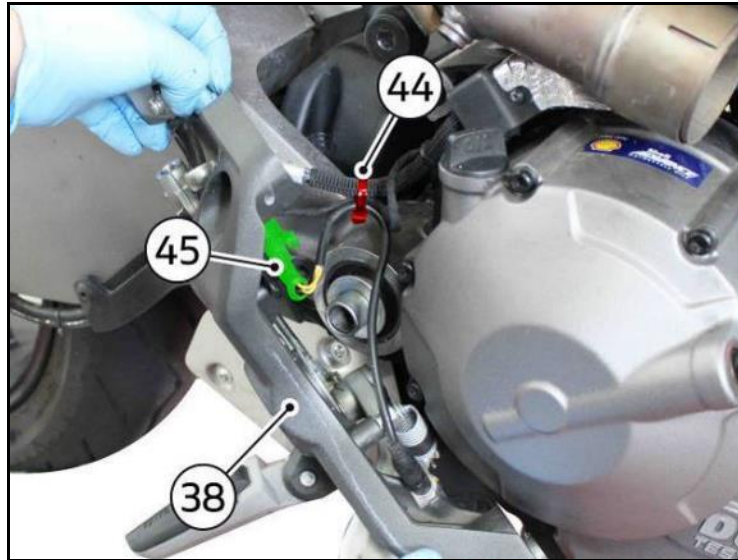

19. Release clutch cable (46) by removing:

- 1 small self-locking tie (47)
- 2 large self-locking ties (48)
- 1 screw M6x25 (49) with relevant spacer (50) and cable guide (51)

20. Slide out nipple and release clutch cable (46) from cable guide (52).

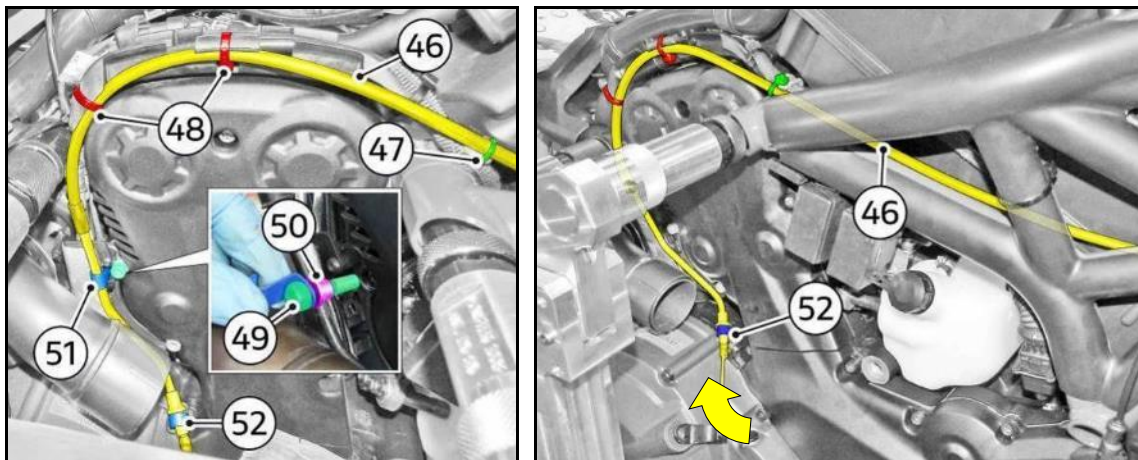



CR214 – Rear Brake Hose Replacement Monster 821 Model Year 2018-2020 (USA-CAN only) Safety Recall Campaign SRV-RCL-21-007

21. Remove the 2 self-tapping screws (53) and slide out the cover (54).

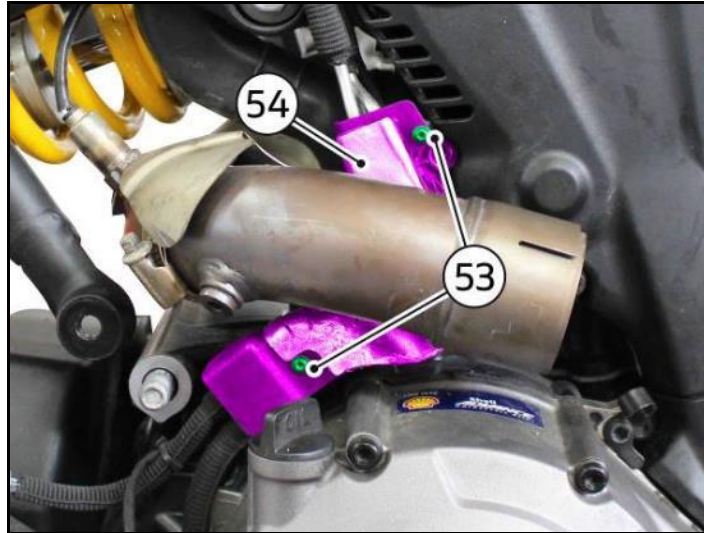

NOTE

To make **cover (54)** removal easier, follow the sequence below:

- move the cover towards motorcycle front end
- turn cover downwards to release its end from the exhaust manifold
- slide out the cover towards motorcycle front end





CR214 – Rear Brake Hose Replacement

Monster 821 Model Year 2018-2020 (USA-CAN only)
Safety Recall Campaign SRV-RCL-21-007

22. Remove the 3 screws M5x12 (55) securing cable guide (56) to swinging arm, then slide it out.

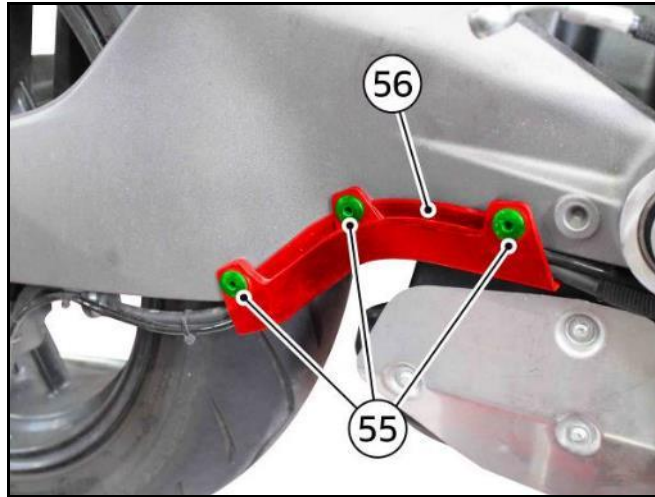

23. To remove the ABS control unit - brake master cylinder and ABS control unit - rear brake caliper hoses, proceed as follows:

24. Remove the 6 large self-locking ties (57) and the small self-locking tie (58).

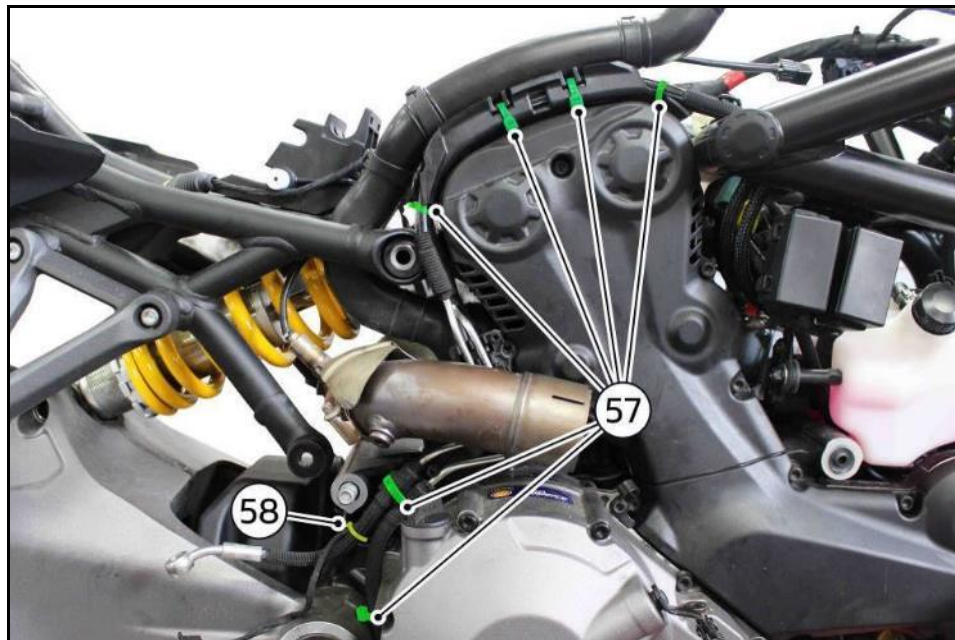



CR214 – Rear Brake Hose Replacement Monster 821 Model Year 2018-2020 (USA-CAN only) Safety Recall Campaign SRV-RCL-21-007

25. The 4 small self-locking ties (59) and the hose grommet (60) by removing the relevant retaining screw.

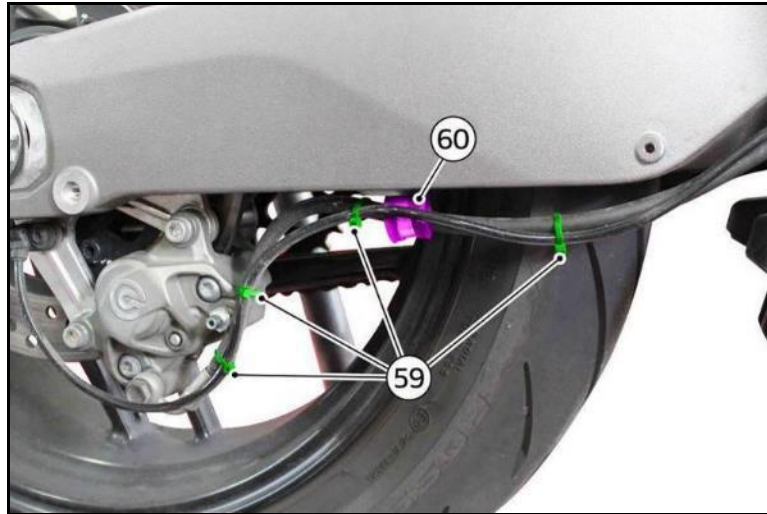

Part 2: Rear Brake Hoses Removal

1. Working on ABS control unit, remove the special screw (61) with the 2 copper washers (62).



WARNING

Brake fluid may damage the paint or parts of the motorcycle. Wash the affected area with plenty of water in case of accidental contact. Damage to finish and components due to brake fluid contact are not covered by warranty and are the responsibility of the dealer to repair

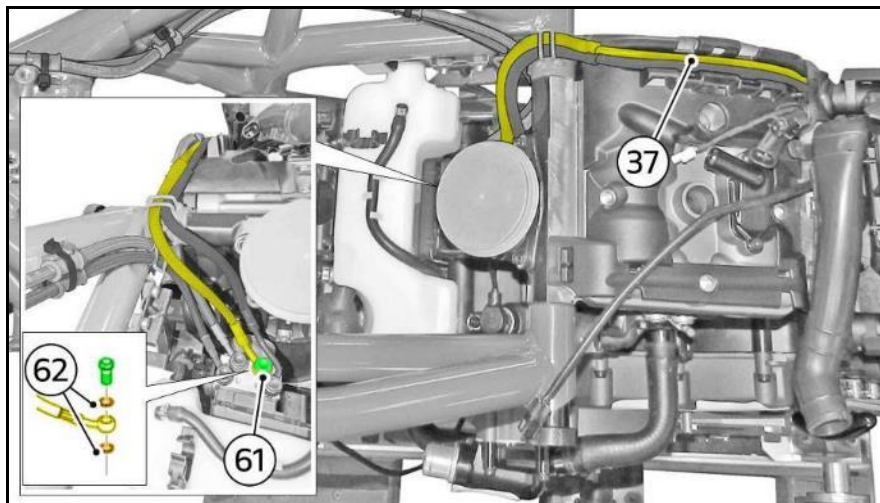



CR214 – Rear Brake Hose Replacement Monster 821 Model Year 2018-2020 (USA-CAN only) Safety Recall Campaign SRV-RCL-21-007

2. Pull out the **brake hose (37)** towards the front end following the sequence of operations indicated below:
 - Route the ABS control unit fitting below the wiring support
 - Release **brake hose (37)** from **cable guide (63)**

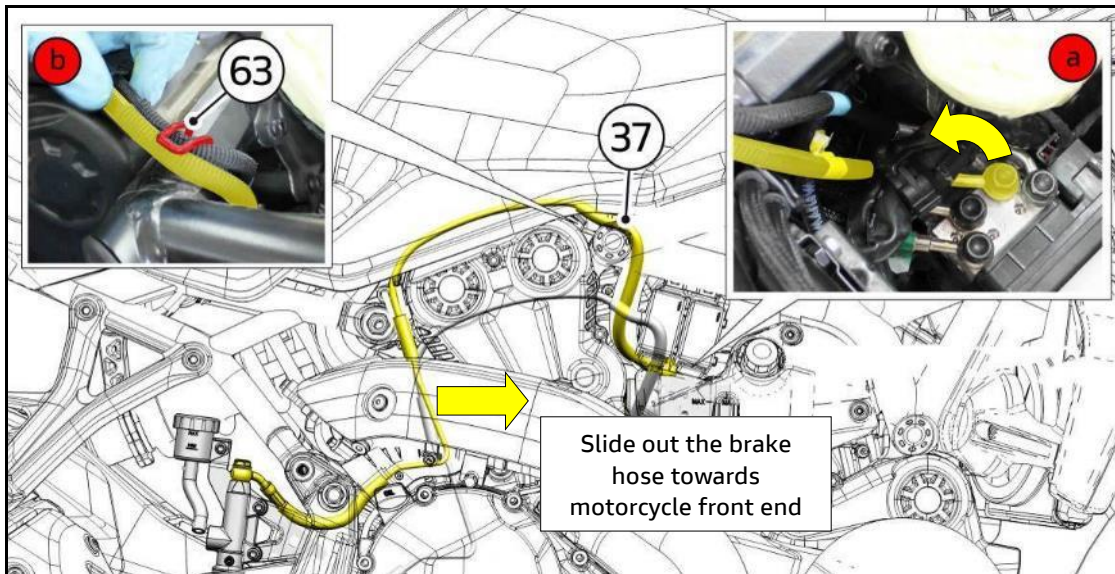

3. Working on the ABS control unit, remove the **special screw (64)** with the **2 copper washers (65)** securing **brake hose (66)** to ABS control unit.
4. Working on the rear brake caliper, remove the **special screw (67)** with the **2 copper washers (68)** securing **brake hose (66)** to rear brake master cylinder.

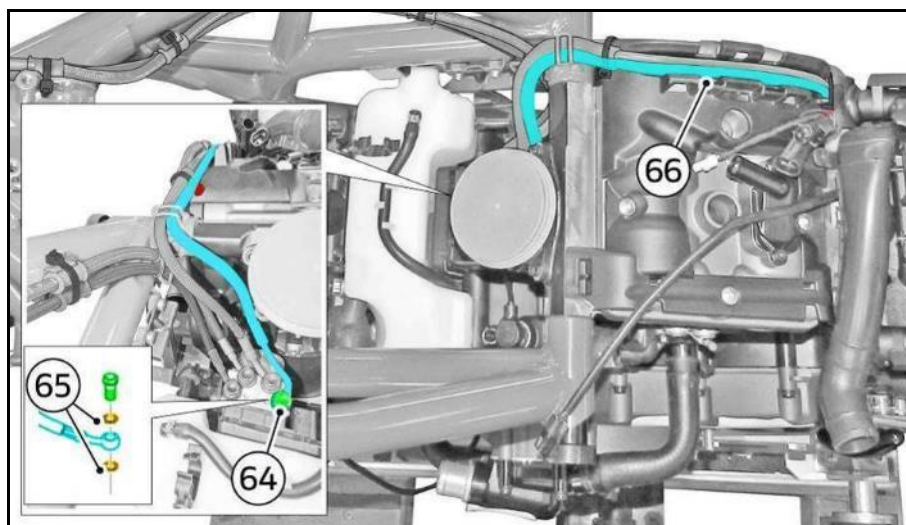



CR214 – Rear Brake Hose Replacement Monster 821 Model Year 2018-2020 (USA-CAN only) Safety Recall Campaign SRV-RCL-21-007

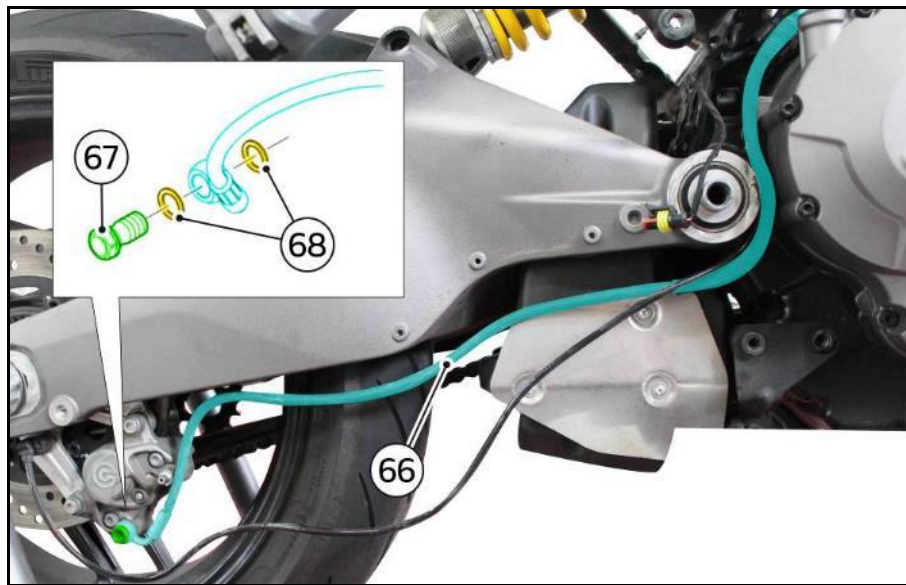

5. Pull out the brake hose (66) towards the front end following the sequence of operations indicated below:
- Route the ABS control unit fitting below the wiring support
 - Release brake hose (66) from cable guide (63)

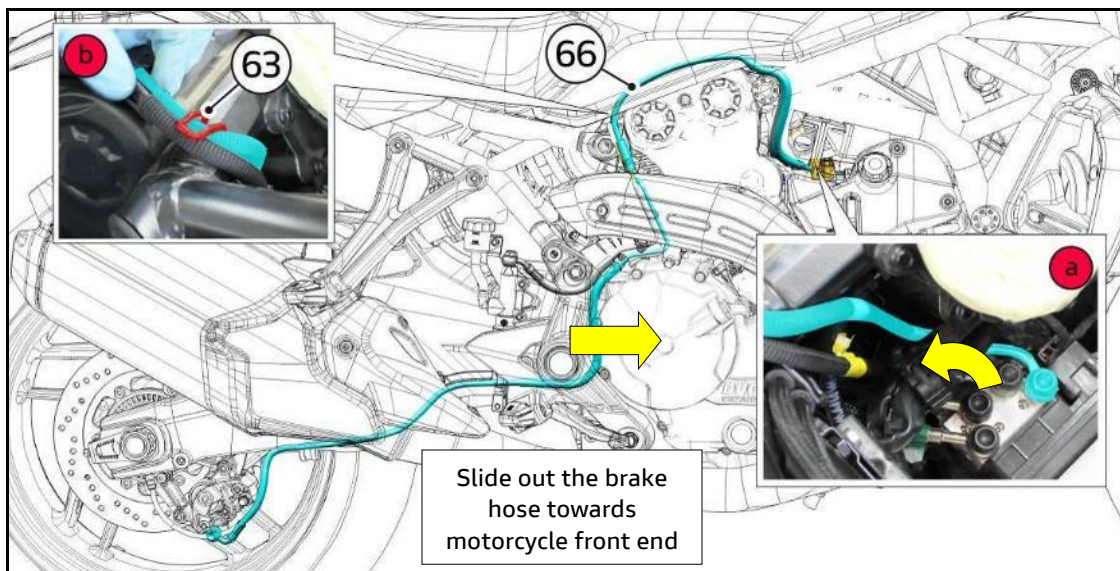



CR214 – Rear Brake Hose Replacement

Monster 821 Model Year 2018-2020 (USA-CAN only)
Safety Recall Campaign SRV-RCL-21-007

- Acting on the vertical head, release the **connector (V)** of the rear stop light sensor branch and the **connector (W)** of the rear speed sensor cable from the **2 button ties L.70 (G)**.
- Remove the **2 self-locking ties (X)** securing the main wiring harness to the **head cover (Y)**.

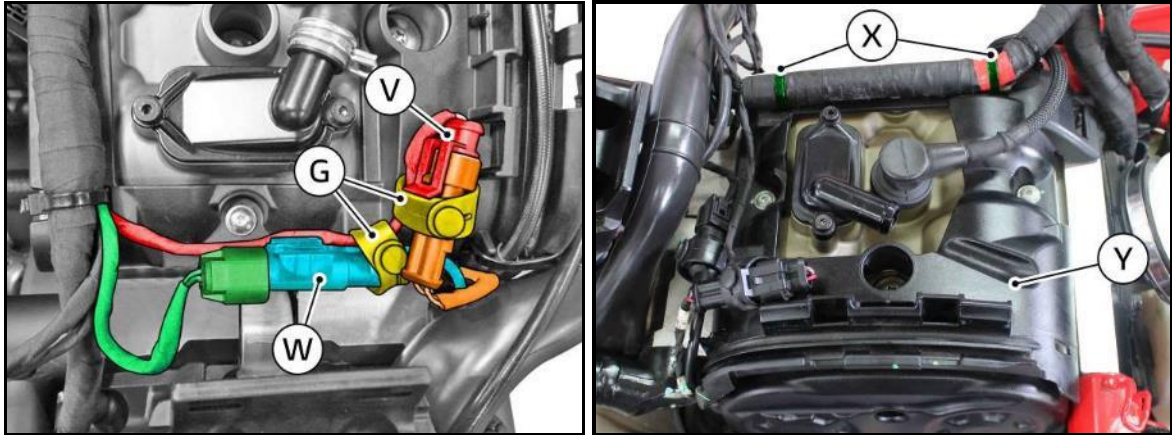

- Remove the **3 screws (Z)** securing **cover (Y)** of the vertical head and then slide it out.

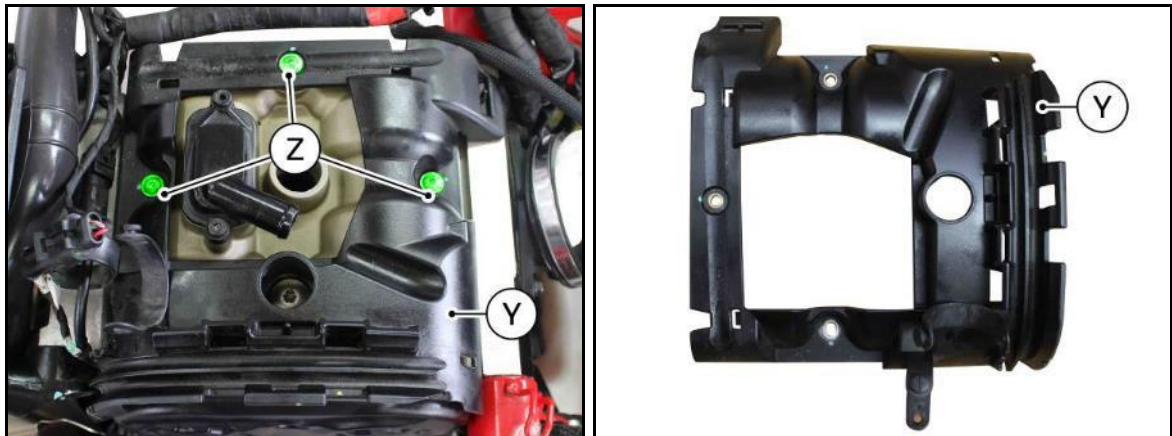

- Take the new vertical head cover included in the KIT.





CR214 – Rear Brake Hose Replacement Monster 821 Model Year 2018-2020 (USA-CAN only) Safety Recall Campaign SRV-RCL-21-007

10. Remove the 2 L.70 button ties (G) and the 2 rubber buffers (H) from the old cover and install them on the new one as shown in the figure.

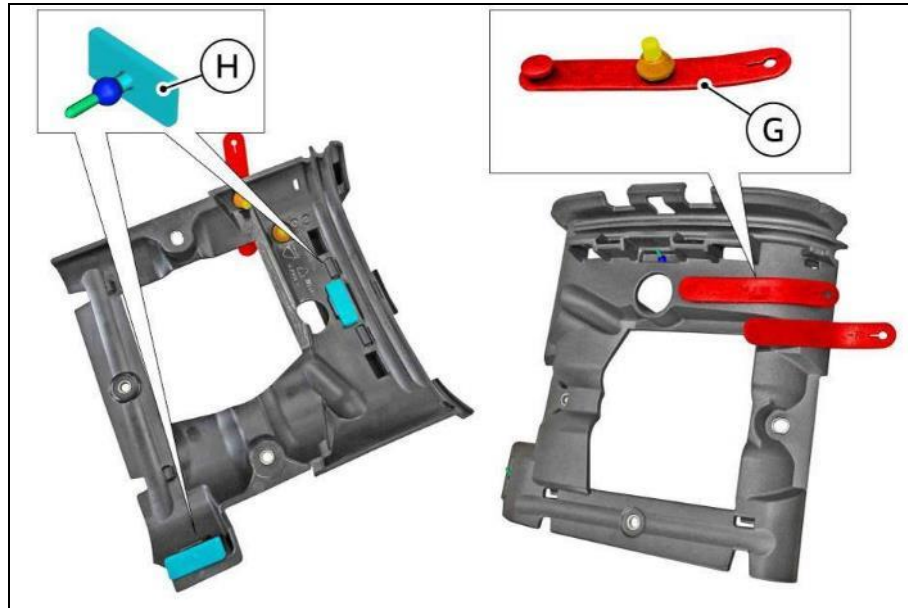

11. Fit the new vertical head cover (A) by tightening the 3 fixing screws (Z) to $5\text{ Nm} \pm 10\%$.

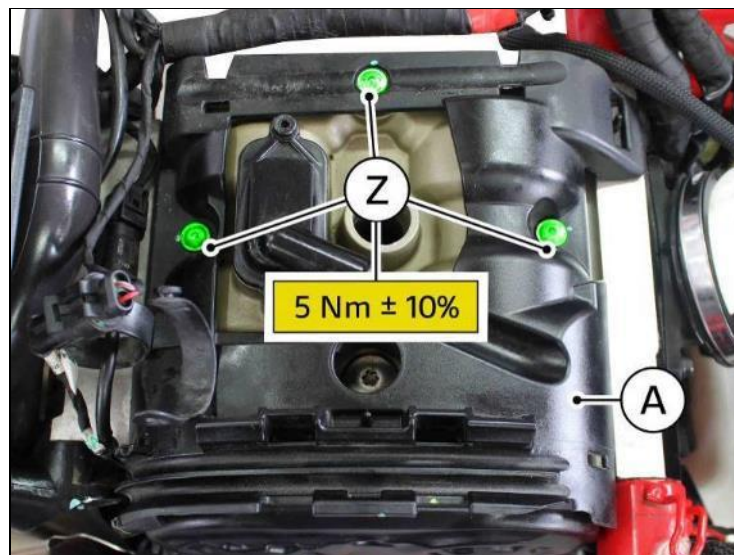



CR214 – Rear Brake Hose Replacement

Monster 821 Model Year 2018-2020 (USA-CAN only)

Safety Recall Campaign SRV-RCL-21-007

12. Fix the main wiring to the **head cover (A)** using the **2 new Velcro ties (T)** as shown in the figure.
13. Fix the **connector (V)** of the rear stop light sensor branch and the **connector (W)** of the rear speed sensor cable from the **2 button ties L.70 (G)** as shown in the figure.

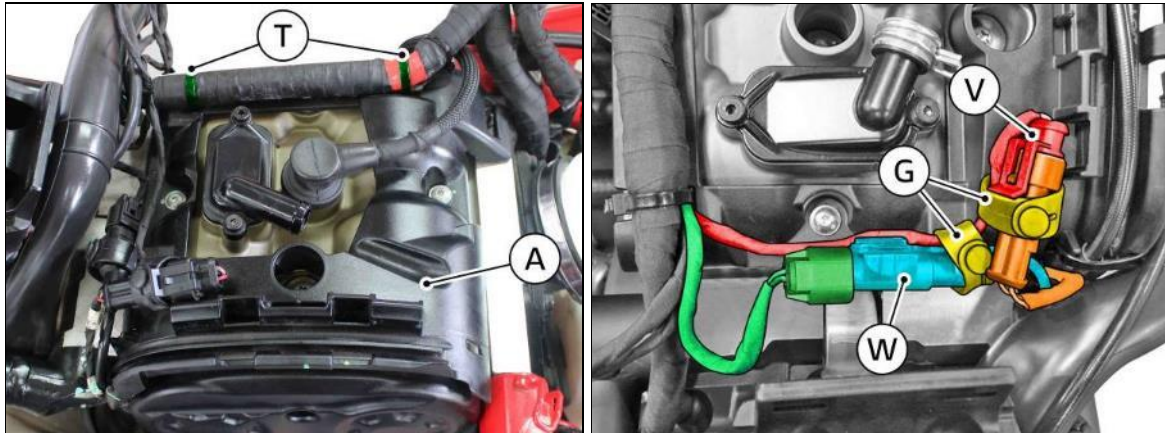

Part 3: Rear Brake Hoses Installation

ABS Control Unit to the Rear Brake Caliper Hose Installation

1. Take the new **brake hose (A)** connecting the ABS control unit to the rear brake caliper.



NOTE

The new brake hose can be recognized by the rigid section that runs along the vertical head, which is longer than the previous one.

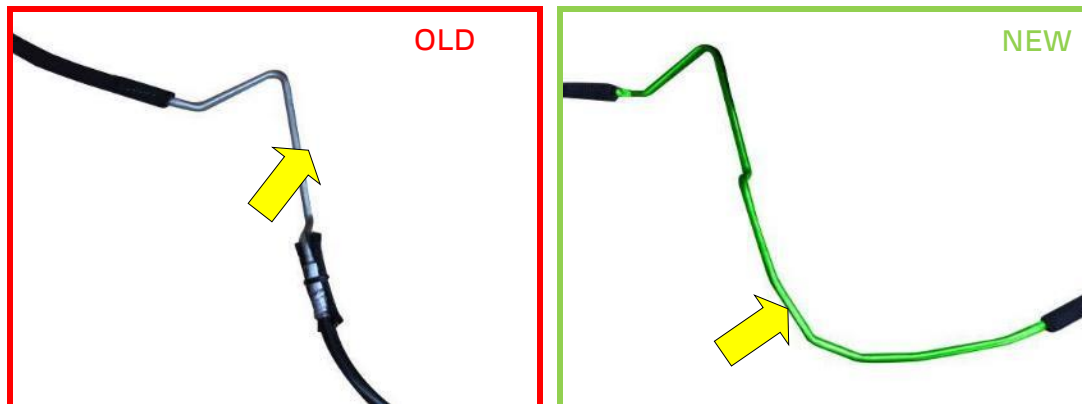



CR214 – Rear Brake Hose Replacement Monster 821 Model Year 2018-2020 (USA-CAN only) Safety Recall Campaign SRV-RCL-21-007

2. Install the new **brake hose (A)** connecting the ABS control unit to the rear brake caliper, as shown below:
- Route the ABS control unit fitting below the wiring support
 - Position **brake hose (A)** inside **cable guide (63)**
 - Position **brake hose (A)** inside **cable guide (69)**, in the position shown in the figure
 - Route **brake hose (A)** between swinging arm and generator cover

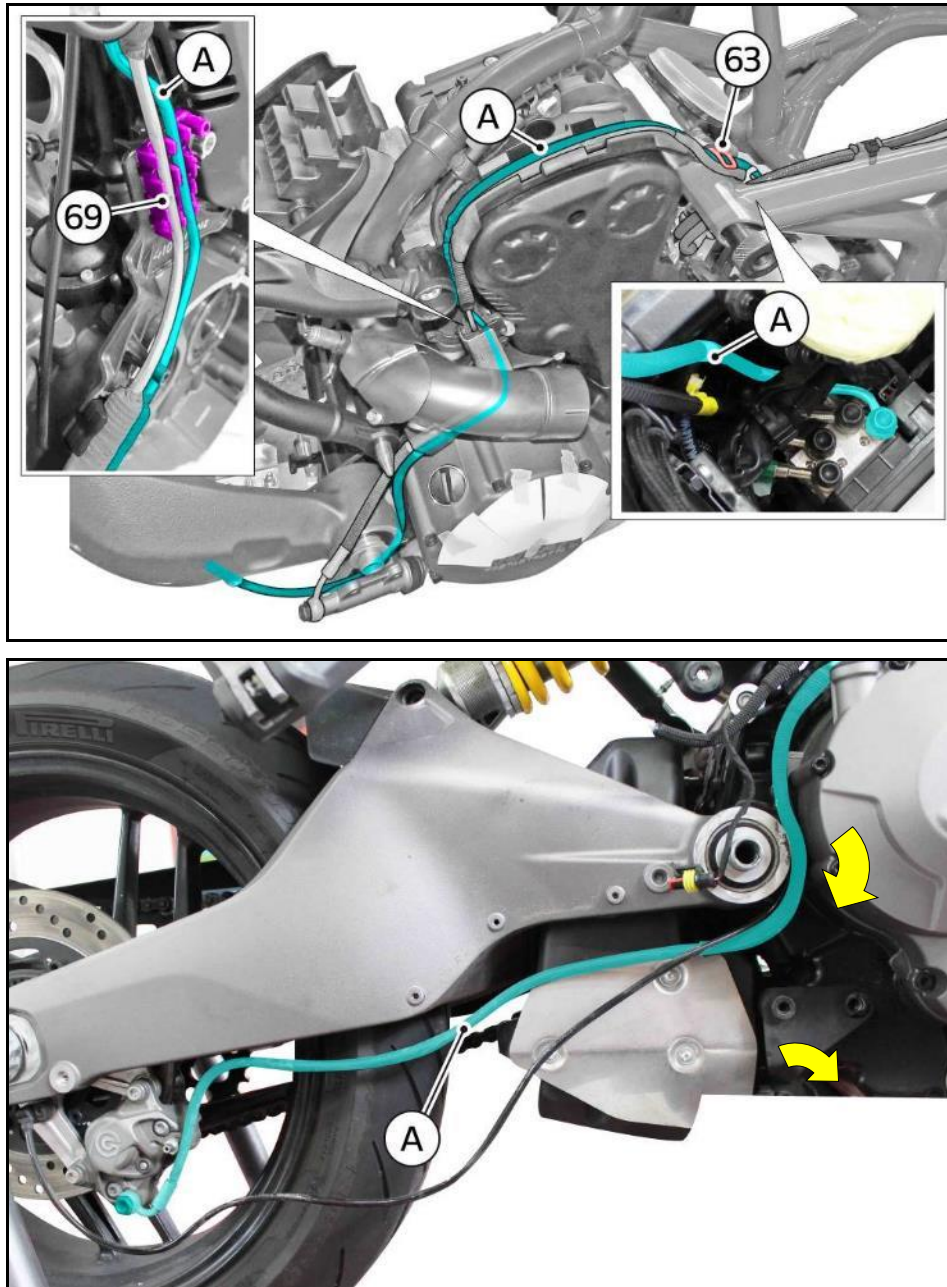



CR214 – Rear Brake Hose Replacement

Monster 821 Model Year 2018-2020 (USA-CAN only)

Safety Recall Campaign SRV-RCL-21-007

3. Fasten the ABS control unit fitting to the control unit as shown in the figure, using **2 new copper washers (B)** and tighten the **special screw (64)** to **25 Nm ± 5% with certification.**
4. Fasten the rear brake caliper fitting, aiming it as shown in the figure, using **2 new copper washers (C)** and tighten the **special screw (67)** to **25 Nm ± 5% with certification.**



NOTE

Due to the presence of the elongated rigid section, the brake hoses are not easy to handle, unlike the old ones, so tightening the fittings on the ABS control unit requires greater care to avoid damaging the threads on the ABS control unit.

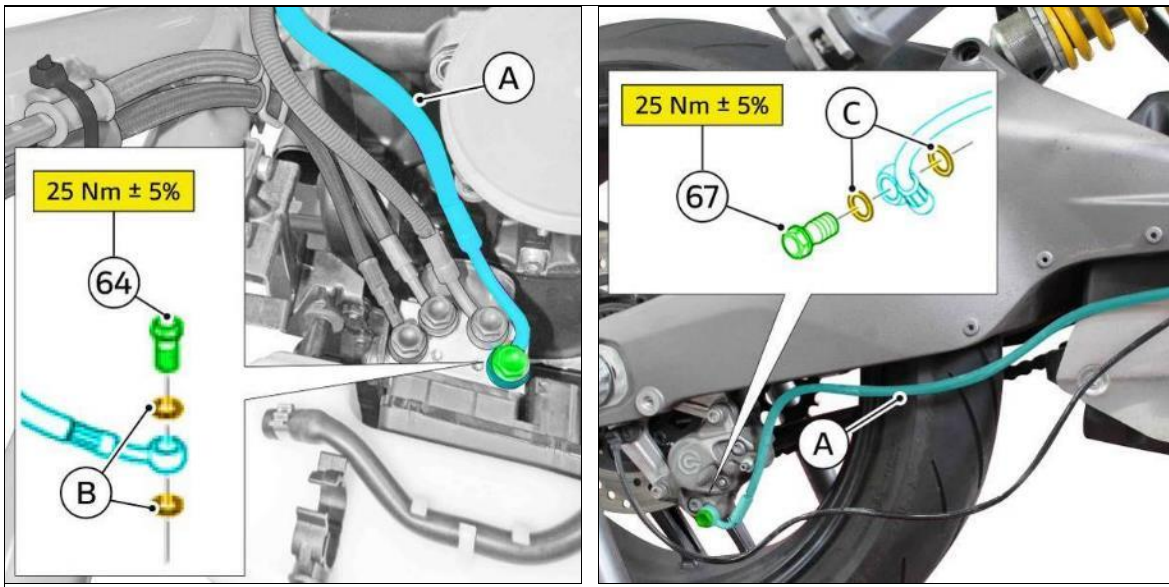



CR214 – Rear Brake Hose Replacement Monster 821 Model Year 2018-2020 (USA-CAN only) Safety Recall Campaign SRV-RCL-21-007

Rear Brake Master Cylinder to ABS Control Unit Hose Installation

1. Take the new **brake hose (D)** connecting the ABS control unit to the rear brake master cylinder.



NOTE

The new brake hose can be recognized by the rigid section that runs along the vertical head, which is longer than the previous one.

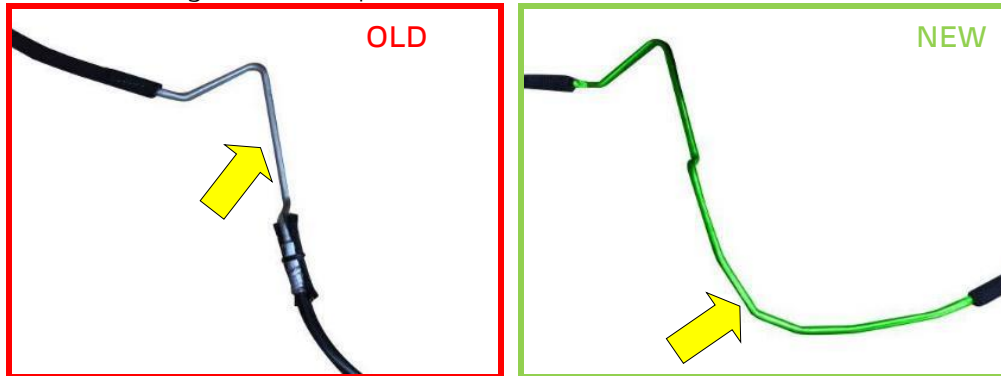

2. Install the new **brake hose (D)** connecting the ABS control unit to the rear brake master cylinder, as shown below:
 - Route the ABS control unit fitting below the wiring support.
 - Position **brake hose (D)** inside **cable guide (63)**, close to brake hose (A).
 - Position **brake hose (D)** inside **cable guide (69)**, in the position shown in the figure.

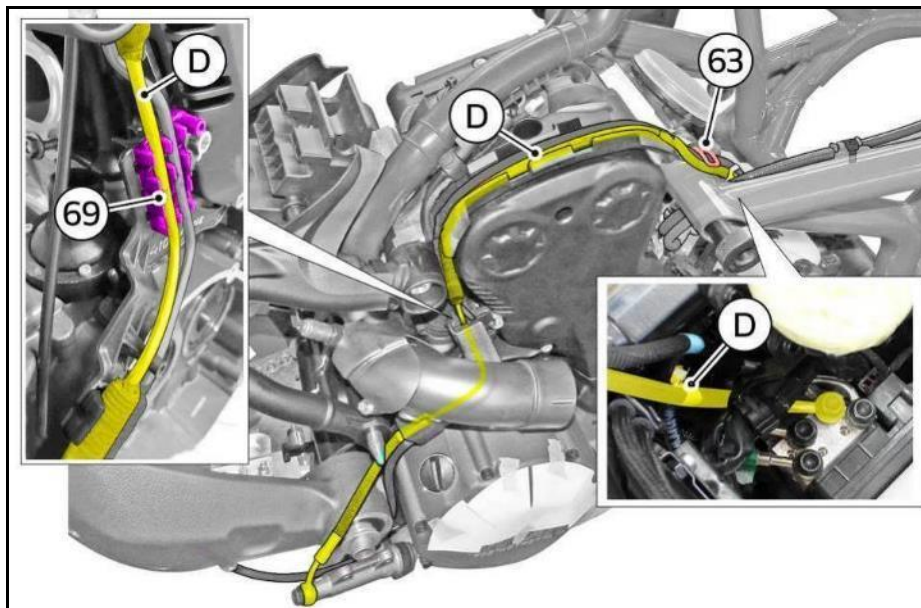



CR214 – Rear Brake Hose Replacement Monster 821 Model Year 2018-2020 (USA-CAN only) Safety Recall Campaign SRV-RCL-21-007

3. Before fastening the fittings of brake hose (D):

- Tie the brake hoses (A) and (D) to the vertical head cover using the 2 large self-locking ties (72), aiming these latter as shown in the figure
- Tie the brake hoses (A) and (D) to the hose grommet (69) using the 2 large self-locking ties (73), aiming these latter as shown in the figure
- Tie the brake hoses (A) and (D) close to the vertical head-rear subframe connector using the small self-locking tie (74), aiming this latter as shown in the figure.

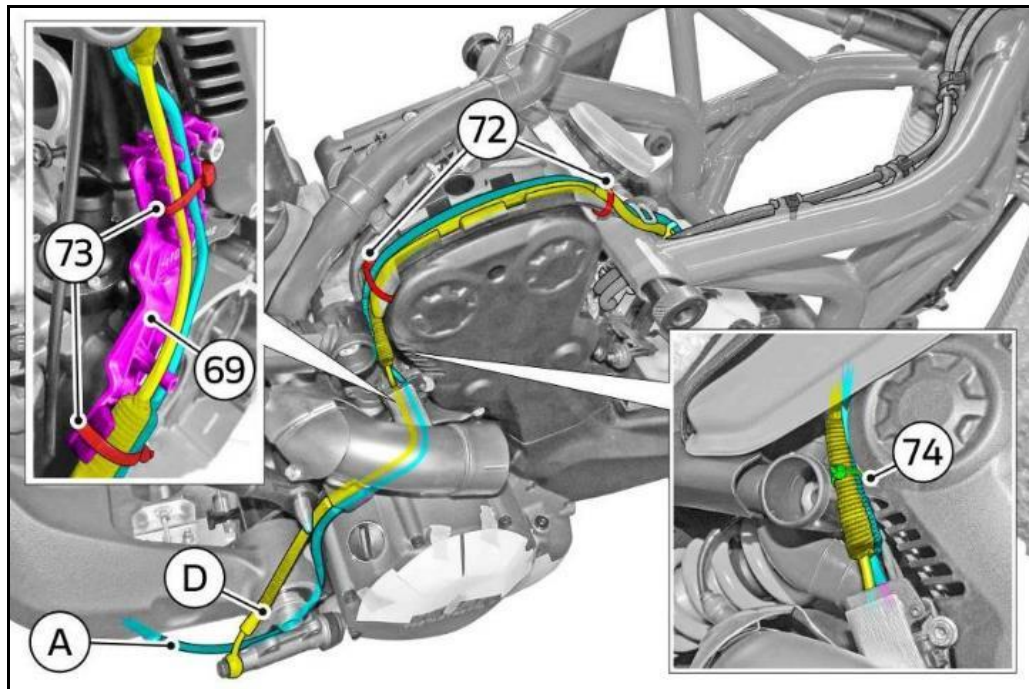

- Tie the brake hose (A) to the rear speed sensor cable using the small self-locking tie (75), aiming this latter as shown in the figure.

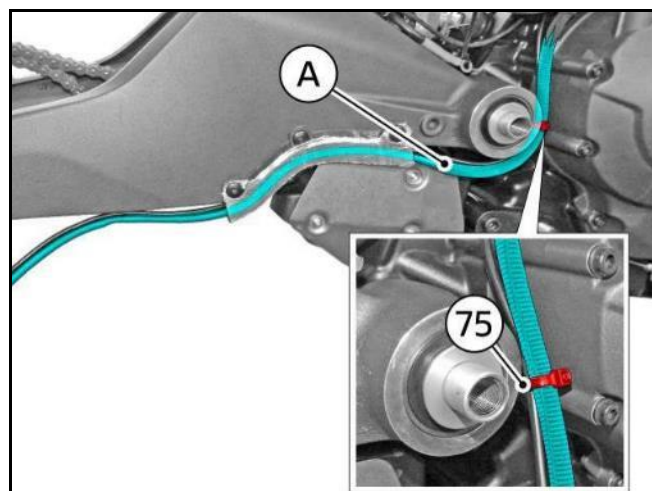



CR214 – Rear Brake Hose Replacement

Monster 821 Model Year 2018-2020 (USA-CAN only)

Safety Recall Campaign SRV-RCL-21-007

4. Take the **footpeg holder plate assembly (38)** and tie the brake hose (D) to the rear stop light sensor wiring using the small self-locking **tie (70)**, aiming this latter as shown in the figure
5. Connect the rear stop light **connector (45)**



NOTE

When fitting the RH front footpeg holder plate assembly, make sure that **bushing (71)** is present on swingarm shaft and take care not to damage the brake hose and wiring.

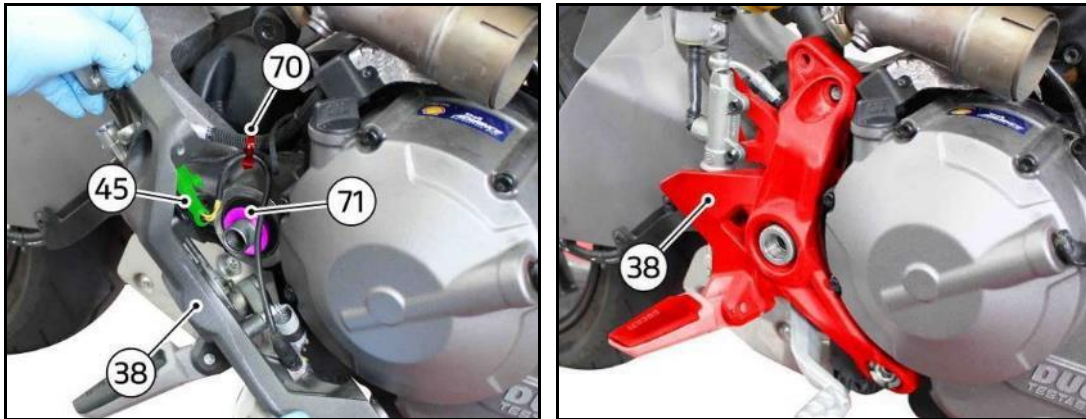

6. Fasten the RH front footpeg holder **plate (38)** assembly following the sequence below:
 - Tighten **special screw (42)** to **72 Nm \pm 5%** with grease GADUS S2 V220 AD 2 (or equivalent) + certification
 - Tighten **nut (41)** to **60 Nm \pm 5%** with grease GADUS S2 V220 AD 2 (or equivalent) + certification while holding it from the opposite side
 - Tighten **screw M10x50 (43)** to **45 Nm \pm 5%** with grease GADUS S2 V220 AD 2 (or equivalent) + certification
 - Tighten **special screw (39)** to **25 Nm \pm 5%** while holding **nut M8 (40)** and certify

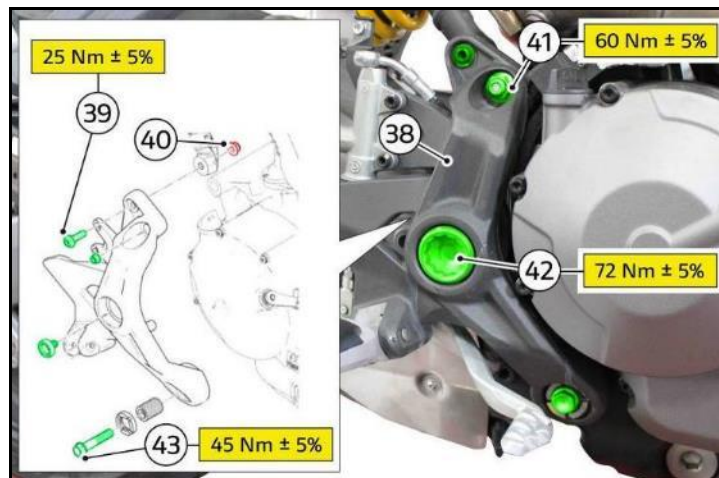



CR214 – Rear Brake Hose Replacement Monster 821 Model Year 2018-2020 (USA-CAN only) Safety Recall Campaign SRV-RCL-21-007



NOTE

Check the correct alignment between the footpeg holder plate and the swinging arm.

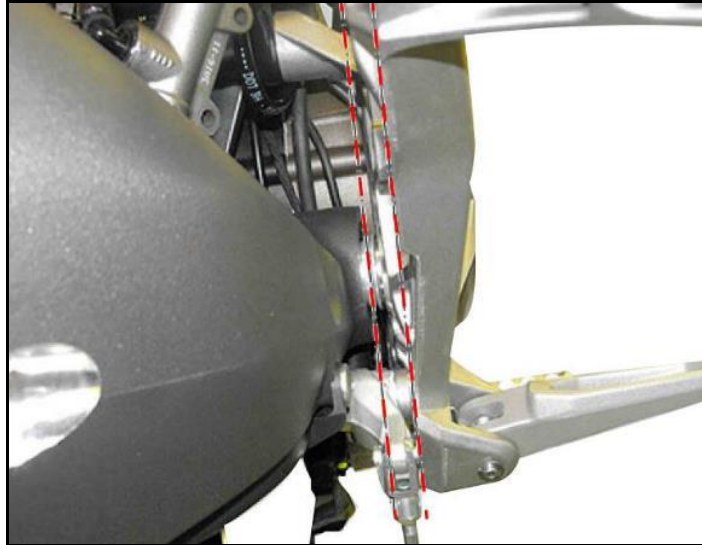

7. Fasten the fitting to the ABS control unit as shown in the figure, using **2 new copper washers (E)** and tighten the **special screw (61)** to **25 Nm ± 5% with certification.**
8. Fasten the rear brake master cylinder fitting as shown in the figure using **2 new copper washers (F)** and tighten the **special screw (63)** to **25 Nm ± 5% with certification.**



NOTE

Due to the presence of the elongated rigid section, the brake hoses are not easy to handle, unlike the old ones, so tightening the fittings on the ABS control unit requires greater care to avoid damaging the threads on the ABS control unit.

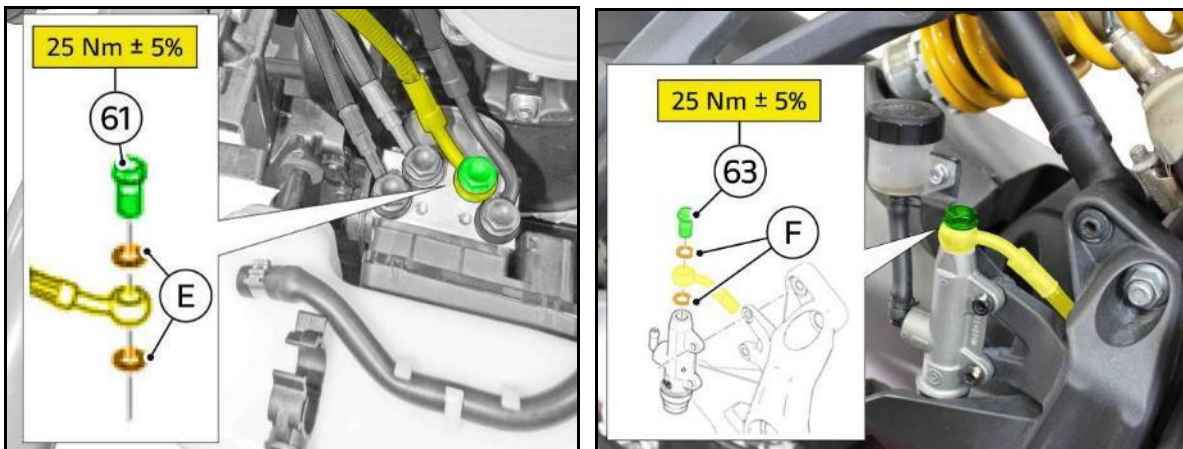



CR214 – Rear Brake Hose Replacement Monster 821 Model Year 2018-2020 (USA-CAN only) Safety Recall Campaign SRV-RCL-21-007



WARNING

Make sure that **brake hose (A)** and **brake hose (D)** fittings are aimed on the ABS control unit as shown in the figure and check also that there are no interferences.

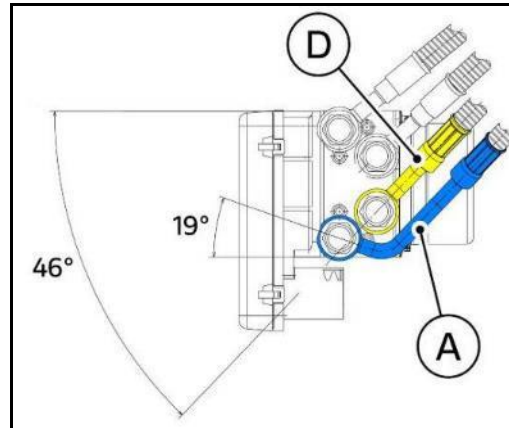

WARNING

Make sure that **brake hose (A)** and **brake hose (D)** fittings are respectively aimed on the brake caliper and brake master cylinder as shown in the figure.

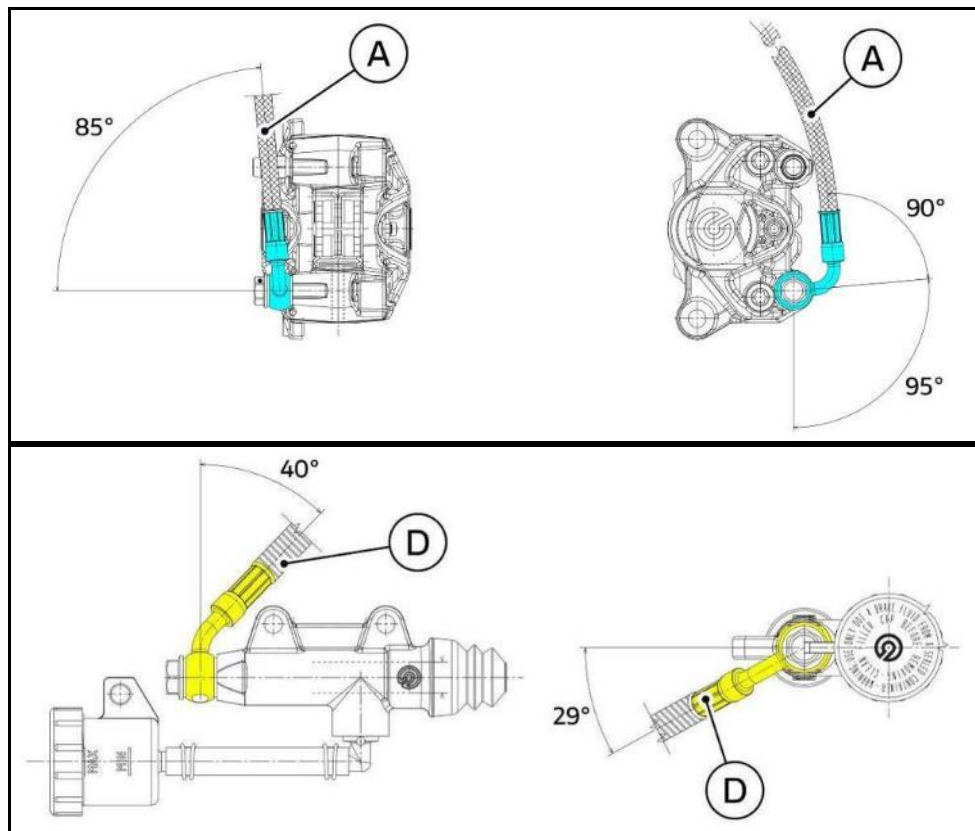



CR214 – Rear Brake Hose Replacement Monster 821 Model Year 2018-2020 (USA-CAN only) Safety Recall Campaign SRV-RCL-21-007

Part 4: Rear Brake System Filling and Bleeding

Proceed with the DOT4 fluid filling inside the rear brake system and bleed the system following the procedure indicated in the bulletin SRV-TTB-17-003 valid for the Monster 821 model.



WARNING

Brake fluid may damage the paint or parts of the motorcycle. Wash the affected area with plenty of water in case of accidental contact. Damage due to brake fluid contact with vehicle component is NOT covered by warranty and is the responsibility of the dealer to repair.

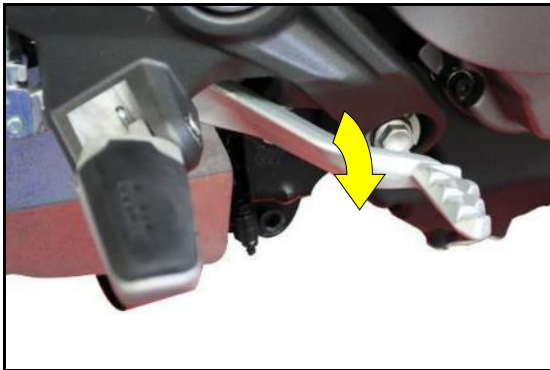

1. Fasten **brake hose (A)** to the swinging arm through **hose grommet (60)** and tighten the relevant retaining screw to **8 Nm \pm 10%**.
2. Tie the **brake hose (A)** to the rear speed sensor cable using the **4 small self-locking ties (76)**, aiming these latter as shown in the figure.

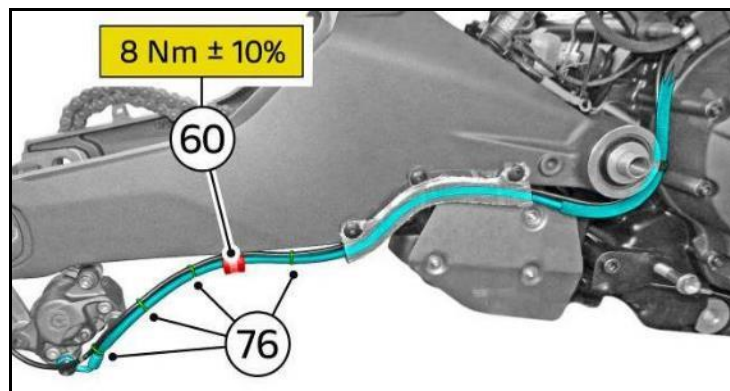



CR214 – Rear Brake Hose Replacement Monster 821 Model Year 2018-2020 (USA-CAN only) Safety Recall Campaign SRV-RCL-21-007

Part 5: Vehicle Refitting and Heat Guard Installation

1. Install **cable guide (56)** on swinging arm by tightening the **3 screws M5x12 (55)** to **5 Nm ± 10%** applying LOCTITE 243 on threads.
2. Position the crank case breather hose on vertical cylinder head and secure it to head cover using the **2 large self-locking ties (77)**, aiming these latter as shown in the figure.

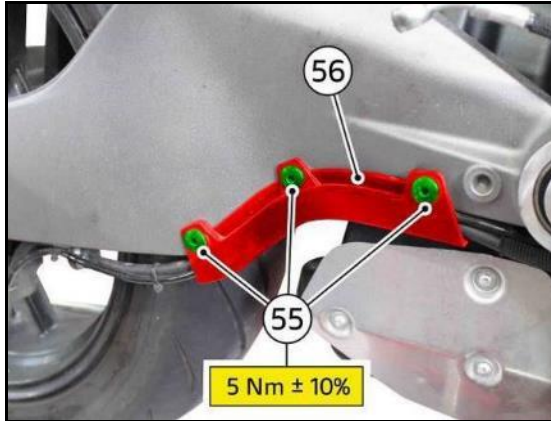

3. Take the new heat guard included in the KIT.





CR214 – Rear Brake Hose Replacement

Monster 821 Model Year 2018-2020 (USA-CAN only)

Safety Recall Campaign SRV-RCL-21-007

4. Take the new heat reflective sheath included in the KIT and remove the protective film from the back.



5. Apply the heat reflective sheath on the heat guard aiming it as shown in the figure.



NOTE

Before applying the heat reflective sheath, make sure that the whole surface on which it will be placed is clean; if it is not so, clean it using a clean cloth.

During the application pay attention to avoid any air bubbles between the heat reflective sheath and the heat guard.





CR214 – Rear Brake Hose Replacement Monster 821 Model Year 2018-2020 (USA-CAN only) Safety Recall Campaign SRV-RCL-21-007

6. Install the new heat guard following the sequence below:
- fit the heat guard by aiming it as shown in the figure;
 - turn the heat guard upwards so as to insert it between exhaust manifold and vertical head belt cover guard;
 - position the heat guard in the relevant seat.

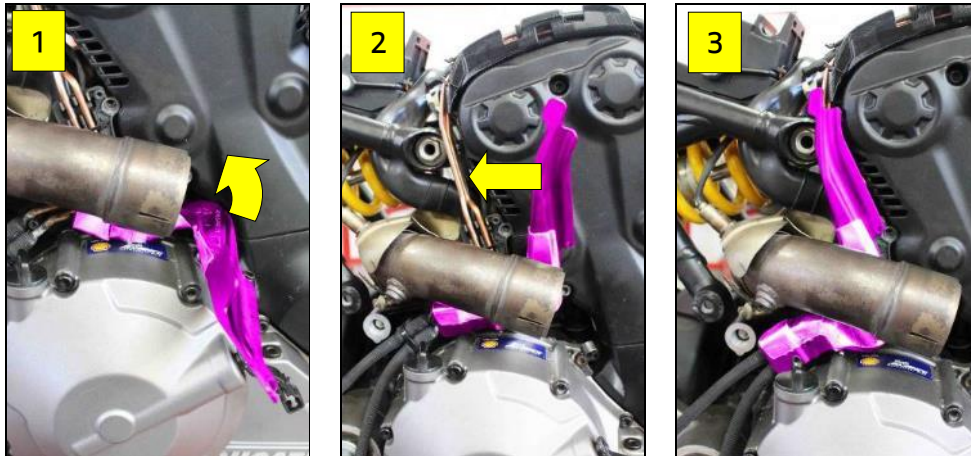

7. Tighten the **2 self-tapping screws (53)** securing the heat guard to **1.6 Nm ± 10%**.



NOTE

Before carrying on with the tightening, start the **2 self-tapping screws (53)** taking care to start them in the original thread already present.

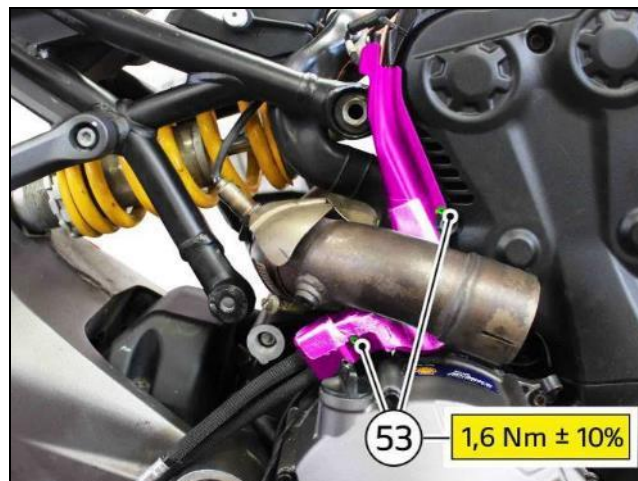



CR214 – Rear Brake Hose Replacement Monster 821 Model Year 2018-2020 (USA-CAN only) Safety Recall Campaign SRV-RCL-21-007

8. Fit clutch nipple and position **clutch cable (46)** as shown below:

- Route **clutch cable (46)** inside **cable guide (52)**
- Position **clutch cable (46)** inside **cable guide (51)**
- Install **cable guide (51)** with **spacer (50)** and tighten **screw M6x25 (49)** to = **10 Nm ± 10%** applying **LOCTITE 243** on threads
- Secure **clutch cable (46)** to wiring protection on vertical head using the **2 large self-locking ties (78)**, aiming these latter as shown in the figure
- Secure **clutch cable (46)** to frame using the small self-locking **tie (79)**, aiming this latter as shown in the figure

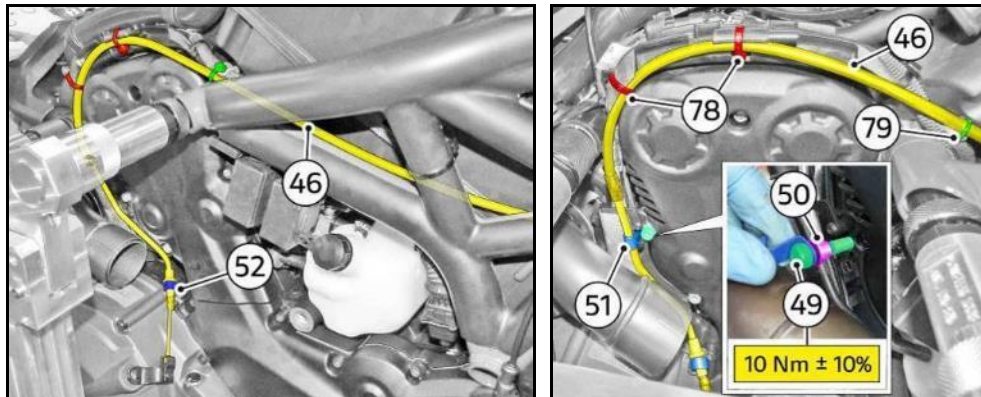

9. Fit the vertical head exhaust manifold (See Sec.8: "Fuel/exhaust system – Exhaust system" of the Workshop Manual 2.0).

10. Fit the silencer (See Sec.8: "Fuel/exhaust system – Exhaust system" of the Workshop Manual 2.0).

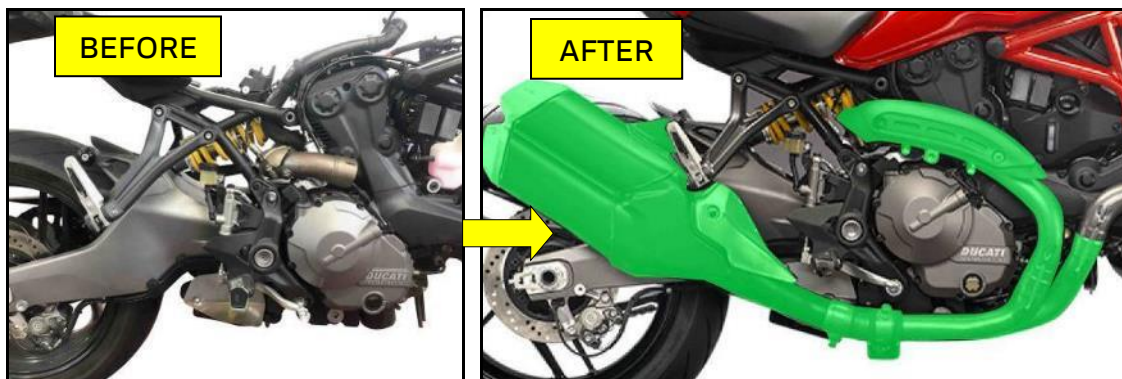



CR214 – Rear Brake Hose Replacement Monster 821 Model Year 2018-2020 (USA-CAN only) Safety Recall Campaign SRV-RCL-21-007

11. Remove the adhesive tape from the intake manifolds.
12. Install the Airbox on the vehicle making sure that the two intake manifolds are perfectly fitted inside it.
13. Working on vehicle RH side, fasten the Airbox using **clamp (34)** positioned on the horizontal cylinder head and **clamp (33)** positioned on the vertical cylinder head and tighten them to **2.5 Nm ± 10%**.

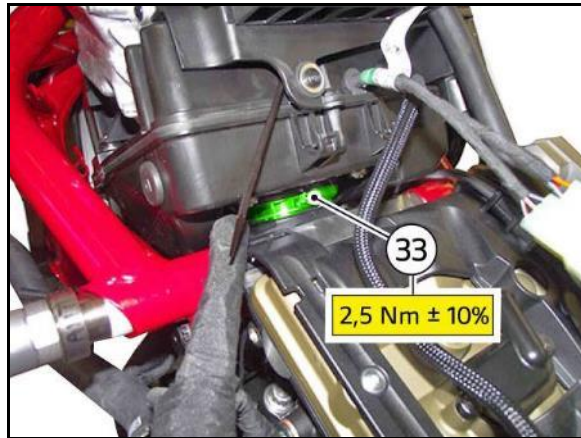
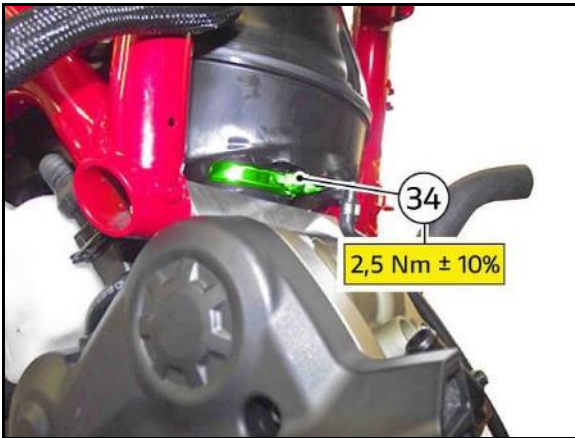

14. Working on vehicle LH side:

14 A. Connect map sensor **connector (32)**

14 B. Install horizontal head pressure sensor **hose (29)** and vertical head pressure sensor **hose (30)** by applying the **2 ties (31)**



NOTE

Position ties with cut parts side facing downwards, as shown in the figure.

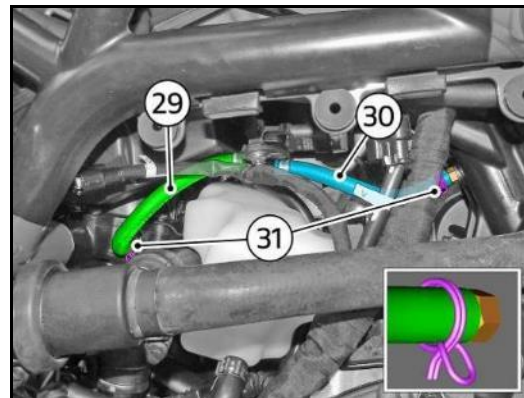



CR214 – Rear Brake Hose Replacement Monster 821 Model Year 2018-2020 (USA-CAN only) Safety Recall Campaign SRV-RCL-21-007

14 C. Install Airbox drain hose (26) and secure it with click clamp (25).

14 D. Install the coil support bracket by tightening the 3 screws M5x20 (27) with the relevant spacers (28) to **6 Nm ± 10%**.

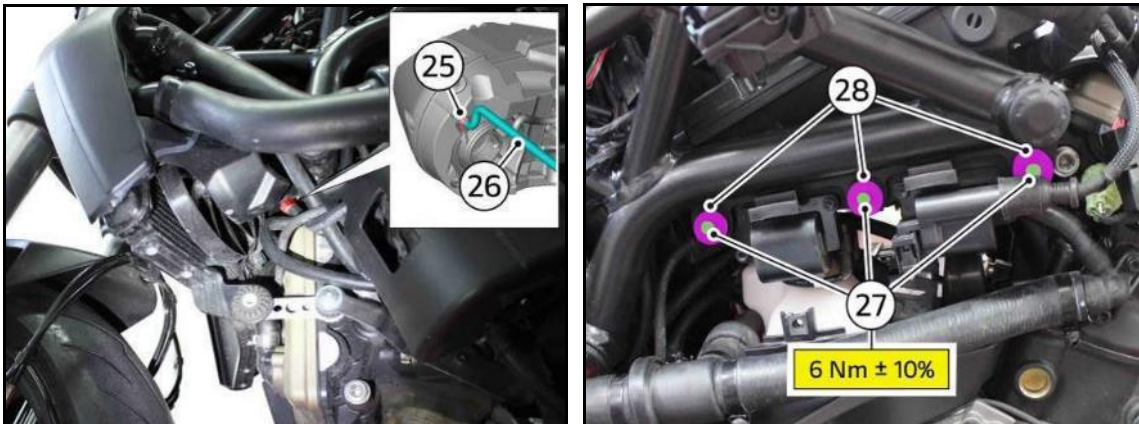

14 E. Insert ignition switch connector (24) in the relevant tab present on the Airbox.

14 F. Connect the air temperature sensor connector (23)

14 G. Using the small self-locking tie (78) join the main wiring front central branch to the airbox clip (close to the red taping and aiming it as shown in the figure).

14 H. Using the small self-locking tie (79) join the main wiring front branch to the air temperature sensor wiring branch (aim it as shown in the figure).

14 I. Using the small self-locking tie (80) join the main wiring front branch to the air filter cover (aim it as shown in the figure).

14 J. Using the large self-locking tie (81) join the ground wiring branch, the ECU wiring branch and the air main wiring front central branch to the main wiring front branch (aim it as shown in the figure).

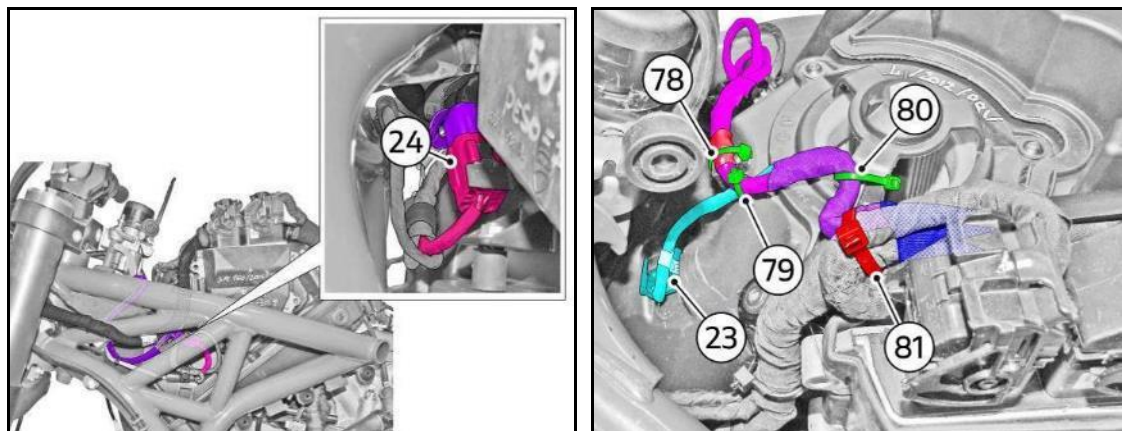



CR214 – Rear Brake Hose Replacement Monster 821 Model Year 2018-2020 (USA-CAN only) Safety Recall Campaign SRV-RCL-21-007

14 K. Connect **2 connectors (20)** of engine ECU.

14 L. Using the small self-locking **tie (82)** join the main wiring primary front branch to the ECU support (aim it as shown in the figure).



NOTE

The main wiring primary front branch must not interfere with **poppet (83)** of ECU.

14 M. Using the **2 large self-locking ties (84)** join the front branch and the ground jointing braided wiring branch to the control unit-relay support (aim them as shown in the figure).

14 N. Using the large self-locking **tie (85)** join the main branch to the control unit-relay support (aim it as shown in the figure).

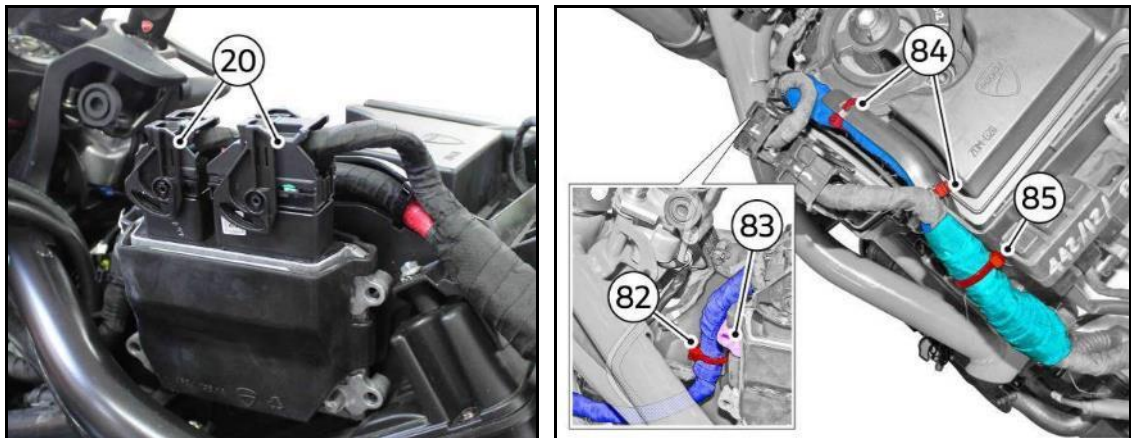

15. Working on vehicle RH side:

15 A. Connect secondary air (AIS) **connector (19)**.

15 B. Install horizontal head secondary air **hose (17)** and vertical head secondary air **hose (18)** by fastening them with the **2 click clamps (16)**.

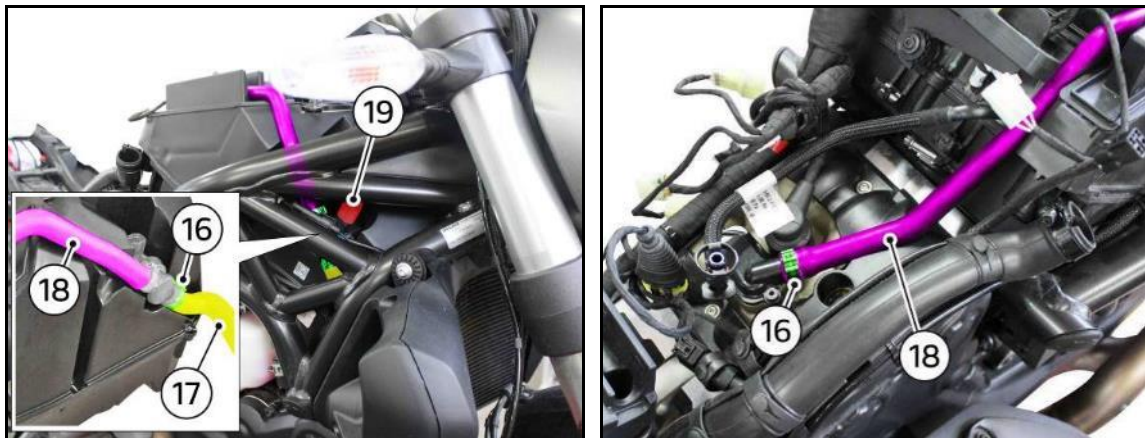



CR214 – Rear Brake Hose Replacement Monster 821 Model Year 2018-2020 (USA-CAN only) Safety Recall Campaign SRV-RCL-21-007



NOTE

Make sure that secondary air **hose (18)** is correctly positioned on the Airbox.

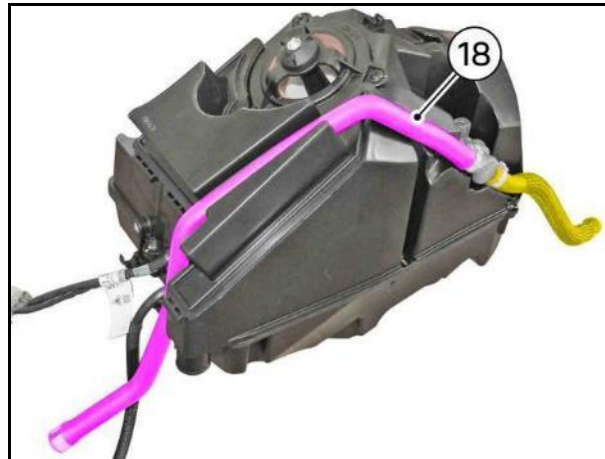

16. Connect injector wiring **connector (9)**, vertical lambda sensor **connector (10)**, potentiometer wiring **connector (11)** and insert starter **relay (12)**, injection **relay (13)** and fuel pump **relay (14)** in the relevant support as shown in the figure.
17. Using the large self-locking **tie (86)** join the main wiring primary central branch to the airbox lower cover (aim it as shown in the figure).
18. Using the large self-locking **tie (87)** join the main wiring secondary central branch to the airbox lower cover (aim it as shown in the figure).

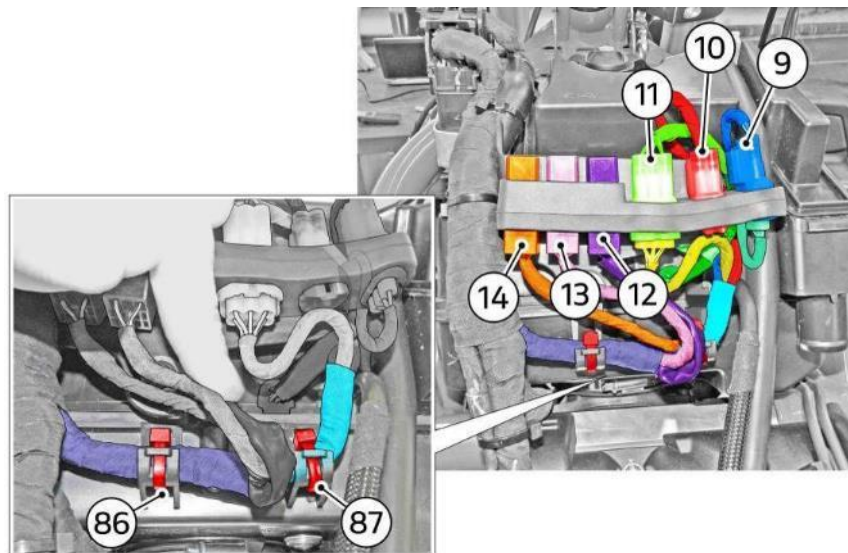



CR214 – Rear Brake Hose Replacement

Monster 821 Model Year 2018-2020 (USA-CAN only)
Safety Recall Campaign SRV-RCL-21-007

19. Fit the crank case breather hose (8) on the Airbox and tighten clamp (7) to 1.5 Nm ± 10%.

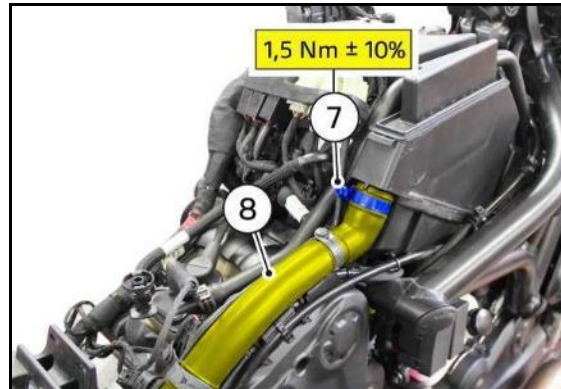

20. Working on the LH side, install cover (2) tightening screw M5x10 (1) to 3 Nm ± 10%.
21. Working on the RH side, install the coolant reservoir cover (6) and tighten the 2 screws M5x9 (3) to 3 Nm ± 10% and screw M6x22 (4) with relevant spacer (5) to 10 Nm ± 10%.

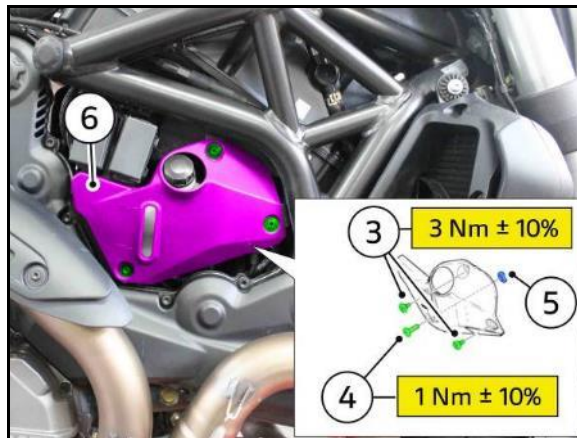
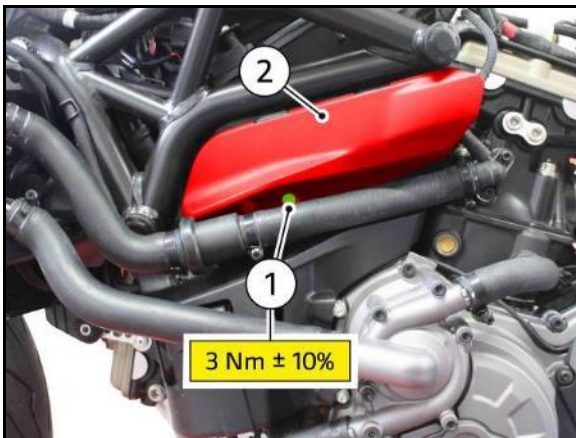

22. Fit the fuel tank (See Sec.8: “Fuel/exhaust system – Fuel tank” of the Workshop Manual 2.0).
23. Start the engine and keep it at idle until reaching the fan activation condition.
24. Connect the DDS 2.0 diagnosis instrument and run a Global Scan.
25. Mount the seat.



CR214 – Rear Brake Hose Replacement

Monster 821 Model Year 2018-2020 (USA-CAN only)

Safety Recall Campaign SRV-RCL-21-007



WARNING

Before measuring the heights (A) and (B) for the brake pedal travel check, always check that the free play travel of the rear brake lever is correct (between 2 mm to 5 mm)

Remember that the idle stroke refers to the stroke performed by the brake cylinder control rod before operating the pump. If the idle stroke is outside the specified values, it must be adjusted again using the adjustment screw on the control rod

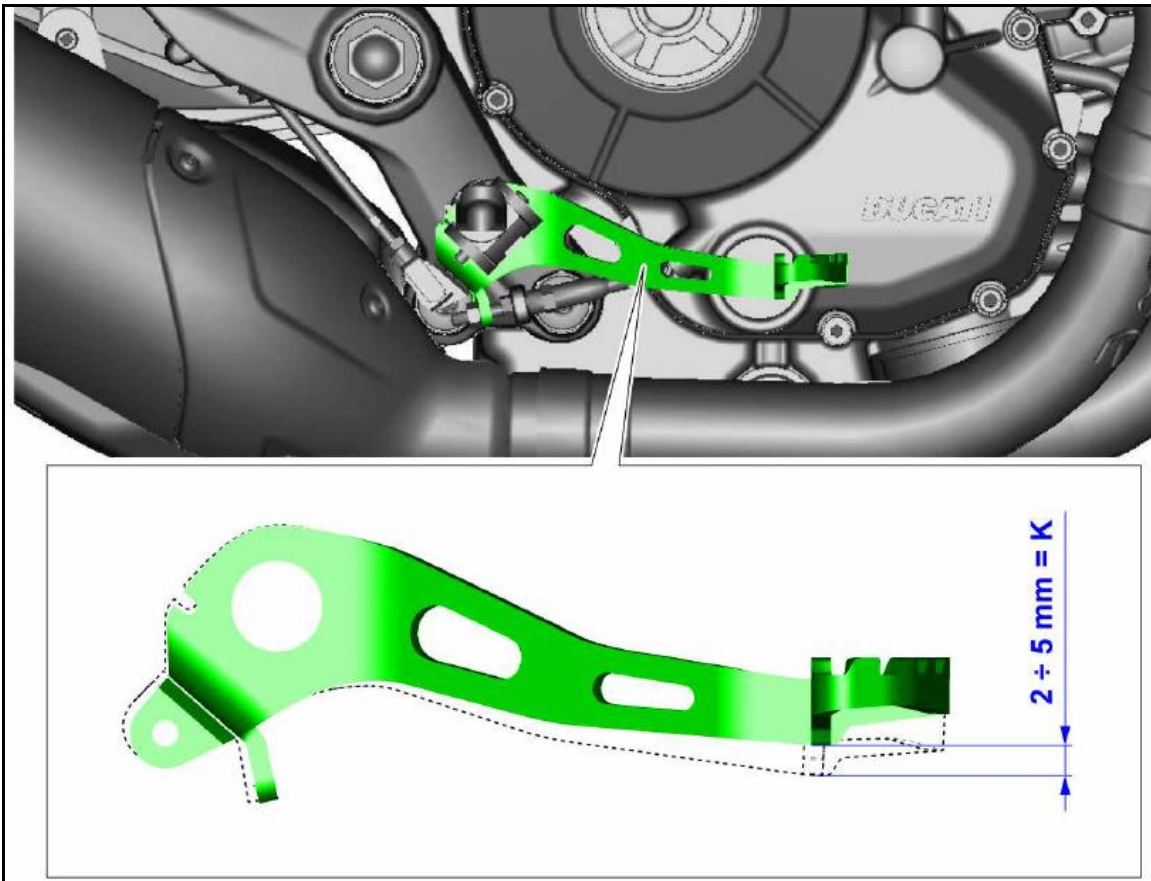



CR214 – Rear Brake Hose Replacement Monster 821 Model Year 2018-2020 (USA-CAN only) Safety Recall Campaign SRV-RCL-21-007

26. Measure height **(A1)** between rear brake lever lower end and load-bearing surface; brake lever must be in rest position (upper limit stop)
27. Slowly position the 8 kg weight onto rear brake lever; then measure height **(B1)** between rear brake lever lower end and load-bearing surface

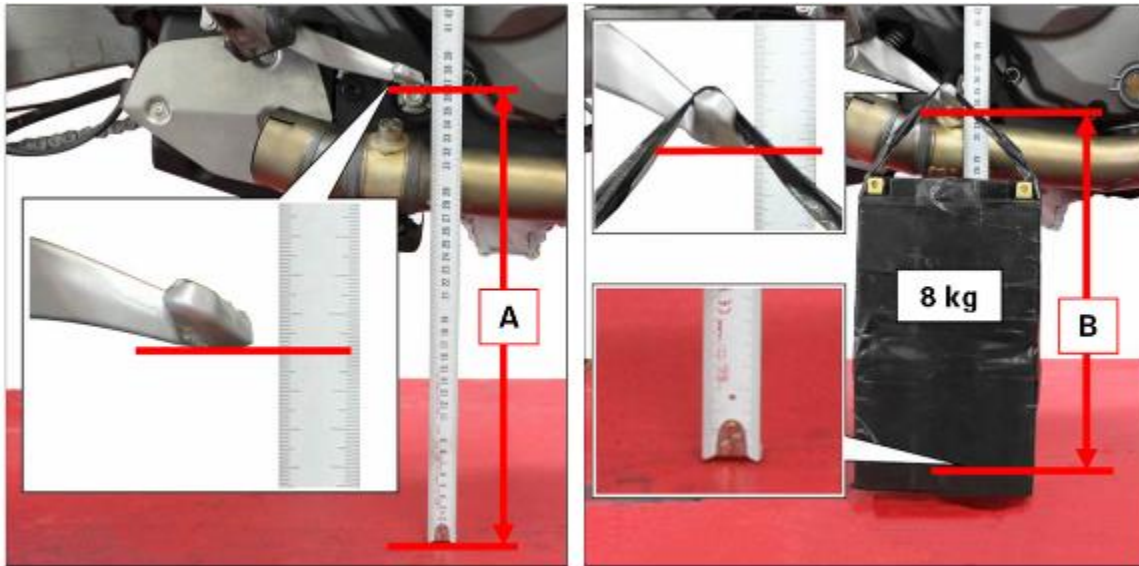

28. Note the difference between the measured heights **(A1)** and **(B1)**

$$\text{Rear brake lever stroke 1} = (A1) - (B1)$$

29. Road test the vehicle on the road at a speed of about 30 mph (50 Km/h) and, by operating only the rear brake, brake until the **ABS is engaged at least 10 times**
30. Measure again the rear brake lever stroke as referred to in steps 26 and 27



WARNING

The measurement of the rear brake lever stroke required must be taken with the same temperature conditions as the previous measurement. Therefore, if the measurement was taken with cold engine it will be necessary to wait for 2 hours before proceeding.

31. Note the difference between the measured heights **(A2)** and **(B2)**.

$$\text{Rear brake lever stroke 2} = (A2) - (B2)$$



CR214 – Rear Brake Hose Replacement

Monster 821 Model Year 2018-2020 (USA-CAN only)
Safety Recall Campaign SRV-RCL-21-007

32. Compare the 2 stroke values of the rear brake lever.
 - If a stroke increase of the rear brake lever is detected, repeat the complete bleed procedure.
 - Once the new bleeding procedure is completed, check that the stroke of the rear brake lever has not increased.
33. Remove the motorcycle from the rear paddock stand
34. Perform a soft cleaning of the motorcycle before delivering it to the Customer



CR214 – Rear Brake Hose Replacement

Monster 821 Model Year 2018-2020 (USA-CAN only)
Safety Recall Campaign SRV-RCL-21-007

Campaign Authorization

Ducati North America, Inc. will mail a notification letter to all known owners. If a customer does not present this notification letter, it is important that you confirm the eligibility for recall status on the DCS before you commence work. Reimbursement requests for duplicate recall campaign repairs will not be accepted.

Dealer Obligation

This program is designed to complete the necessary repairs and to achieve owner satisfaction. Therefore, we ask that you to take prompt and courteous action in accordance with these directives. Please provide a copy of this communication to every person in your dealership who has recall-related responsibilities. Please direct any questions or concerns to your Service Area Manager.

Thank you for your cooperation.

Service Department
Ducati North America, Inc.

For questions on this Workshop Campaign,
please contact your Service Area Manager.



CR214 – Rear Brake Hose Replacement
Monster 821 Model Year 2018-2020 (USA-CAN only)
Safety Recall Campaign SRV-RCL-21-007

IMPORTANT SAFETY RECALL

This notice applies to your vehicle: VIN XXXXXXXXXXXXXXXXXXXX

[NHTSA Recall No. 21V-315](#)

June 30, 2021

Customer Name
Customer Address
City, St, Zip Code

Subject:

Ducati Motorcycle: Monster 821 MY 2018-2020 all versions (USA-CAN only)

NHTSA Campaign I.D. Number: 21V-315

Dealer Bulletin: SRV-RCL-21-007

Dear Ducati Owner,

This notice is sent to you in accordance with the requirements of the U.S. National Traffic and Motor Vehicle Safety Act. Ducati Motor Holding S.P.A. has decided that a defect which relates to motor vehicle safety exists in certain Monster 821 MY 2018-2020 all versions (USA and CAN only). Our records indicate that you are the owner of a Ducati motorcycle affected by this safety recall campaign. Please take the time to read this letter and help us take the appropriate steps to ensure that your vehicle is operating properly.

What is wrong?

It has been determined that due to brake system architecture, there is a potential for greater susceptibility for air permeation through the rear brake hoses into the rear brake system, reducing rear brake effectiveness. If this issue develops during normal use, it develops gradually, providing sufficient warning to the operator that rear braking performance may be degrading. If this issue develops after long periods of time without using the motorcycle, the rider during the pre-ride check (as recommended in the Owner's manual) would be warned by an increase of the rear brake pedal stroke. If this condition remains undetected, a rider who relies on rear braking may experience extended stopping distances, increasing the risk of a crash.

The front and rear brake system for this motorcycle are hydraulically independent; therefore, performance of the front brake, which provides full stopping ability, is NOT affected by the rear brake system.



CR214 – Rear Brake Hose Replacement

Monster 821 Model Year 2018-2020 (USA-CAN only)
Safety Recall Campaign SRV-RCL-21-007

What will Ducati do?

We are informing you of this Non-Compliance Recall on your Ducati motorcycle although we are not able to perform the remedy currently. We will notify you with a follow-up letter as soon as the part is available. When the part is available (estimate date is early Aug 2021), the rear brake lines will be replaced for free and should take about 4 hours. Service time will vary depending on dealer scheduling.

Please contact your local Ducati Service center to schedule an appointment for the repair. You may continue to operate your motorcycle to reach your Ducati authorized dealer. If your rear brake system is inoperable, or if you feel uncomfortable riding the motorcycle, please discontinue operating the vehicle, then contact our roadside assistance provider at 800-234-1353 to facilitate a tow service to your nearest Ducati dealer.

To locate your nearest authorized Ducati dealer, please go to www.ducati.com, and select the “dealer locator” or you may call toll free from the U.S. 1-888-391-5446.

Federal regulations require that any lessor receiving this recall notice must forward a copy of this notice to the lessee within ten days.

Service Problem Help:

If you believe that your dealer has failed or is unable to remedy the defect without charge, or within a reasonable period of time, please contact Ducati North America Customer Care at 1 (888) 391-5446.

If you cannot obtain satisfaction, please use the following options:

For USA Customers:

If you are still having difficulty getting your vehicle repaired in a reasonable time or without charge, you may write the Administrator, National Highway Traffic Safety Administration, 1200 New Jersey Ave. S.E., Washington, D.C. 20590

Or call the toll-free Vehicle Safety Hotline at 1-888-327-4236 (TTY 1- 800-424-9153), or go to www.nhtsa.gov.

For Canadian Customers:

Please contact Ducati customer service at 1-888-391-5446 or for additional information about the recall you, can contact Transport Canada at 1-800-333-0510.



CR214 – Rear Brake Hose Replacement
Monster 821 Model Year 2018-2020 (USA-CAN only)
Safety Recall Campaign SRV-RCL-21-007

TREAD ACT CUSTOMER REIMBURSEMENT PLAN

If you have paid for the repair described in the attached letter, and you would like to be considered for reimbursement, please contact your authorized Ducati dealer. Expenses from repair facilities outside of the authorized Ducati dealer network will be considered; however, the procedure must meet Ducati North America's standards.

Your authorized Ducati retailer will request a copy of your owner notification letter, as well as, a copy of your previously paid invoice. They will inspect the vehicle, if still in your possession, prior to submitting a claim on your behalf to Ducati North America, Inc. for reimbursement. Only a repair involving this safety recall campaign is reimbursable. Ducati North America, Inc will not reimburse consequential expenses such as towing, rental, and accommodations.

We recommend that your authorized Ducati dealer be your primary contact on this issue. We anticipate that your authorized Ducati dealer will be able to answer any questions that you may have regarding your qualifications for reimbursement of a previous repair; additionally, our Customer Relations Dept. may be contacted at 888-391-5446 for any special assistance required.

What if you no longer own the vehicle?

If you no longer own the vehicle, please e-mail your change of ownership information to ContactUs@ducati.com or contact Ducati North America Customer Care at 1 (888) 391-5446.

We regret any inconvenience to you from this action; however, your safety and satisfaction are important to us.

Sincerely,

Richard Kenton
Technical Director – Ducati North America

35.