

Product Safety Recall

N212328800 Front Passenger Airbag Takata Inflator

- Priority Group 10



Release Date: June 2021

Revision: 02

Revision Description: This bulletin has been updated in the parts, warranty, and service procedure sections. This update includes new labor codes for both LD and HD vehicles and a new part number for the HD Pickup Front Passenger Airbag Inflator Kit and bracket. The new requirement information for recording the replacement air bag inflator serial number under the Warranty Information section has also been added to this bulletin. Please discard all previous copies of N212328800.

Attention: It is a violation of Federal law for a dealer to deliver a new motor vehicle or any new or used item of motor vehicle equipment (including a tire) covered by this notification under a sale or lease until the defect or noncompliance is remedied.

All involved vehicles that are in dealer inventory must be held and not delivered to customers, dealer traded, or used for demonstration purposes until the repair contained in this bulletin has been performed on the vehicle.

NHTSA defined priority groups are determined by vehicle location and model year. Vehicles involved in this recall were originally part of bulletin N202324210. This bulletin will be closed 2/5/21 and affected vehicles will now show under this safety recall.

Due to age and environmental exposure, some vehicles may display warping or cracking around the passenger airbag opening in the upper instrument panel area. Inspect this area with the customer at the time of the vehicle repair order write up. If warping or cracking is found, inform the customer that the condition is not covered by this recall, nor is it caused by the airbag service procedure. This warping or cracking condition will not affect the passenger side airbag deployment.

Dealers are to refer to the General Motors Service Policies and Procedures Manual, Regional Product Field Actions, for guidelines on handling vehicles that are not involved in this safety recall but may be displaying the same condition.

Make	Model	Model Year		RPO	Description
		From	To		
Cadillac	Escalade EXT	2010	2013		
	Escalade, Escalade ESV	2010	2014		
Chevrolet	Avalanche	2010	2013		
	Silverado 1500	2010	2013		
	Silverado 2500/3500	2010	2014		
	Suburban	2010	2014		
	Tahoe	2010	2014		
GMC	Sierra 1500	2010	2013		
	Sierra 2500/3500	2010	2014		
	Yukon, Yukon XL	2010	2014		

Involved vehicles are marked "Incomplete-Limited or No Parts" on the Investigate Vehicle History screen in GM Global Warranty Management system. This site should always be checked to confirm vehicle involvement prior to beginning any required inspections and/or repairs.

Condition	TK Holdings Inc. ("Takata") has decided that a defect which relates to motor vehicle safety exists in the passenger-side frontal airbag inflators installed as original equipment in certain 2010 -2013 model year Cadillac Escalade EXT vehicles; certain Chevrolet Avalanche, Silverado 1500; certain GMC Sierra 1500 vehicles; and certain 2010-2014 model year Cadillac Escalade, Escalade ESV vehicles; certain Silverado 2500/3500, Suburban, and Tahoe vehicles; and certain GMC Sierra 2500/3500, Yukon, and Yukon XL vehicles. The determination was made that the propellant in these inflators may degrade after long-term exposure to high humidity and temperature cycling, which could cause the inflator to rupture during a deployment. An inflator rupture may cause metal fragments to pass through the airbag and into the vehicle interior at high speed, which may result in injury or death to vehicle occupants.
Correction	Dealers will replace the passenger-side frontal airbag inflator.

Product Safety Recall

N212328800 Front Passenger Airbag Takata Inflator

- Priority Group 10



Parts

Quantity	Part Name	Part No.
1	Front Passenger Airbag Inflator Kit (Dual Stage - LD pickup and all SUV Vehicles)	84304240
1	Front Passenger Airbag Inflator Kit (Single Stage – HD pickup Only)	84594241*
1	Bracket (Required for Single Stage – HD Pickup Only)	84594242*

Parts required to complete this recall are to be obtained from General Motors Customer Care and Aftersales (GMCCA). Please refer to your “involved vehicles listing” before ordering parts. Order parts on a CSO = Customer Special Order only. DRO’s may be cancelled. All orders may be reviewed prior to being filled. Parts may have quantity limiters in effect. Orders may write to backorder until reviewed. Orders are reviewed and released daily. DO NOT SPAC.

Important: Due to flight restrictions for hazardous goods shipments, dealer orders may arrive via FedEx or with your normal PDC delivery. Therefore, dealers should order CSO = Customer Special Order as DRO’s may be cancelled. Please do not place orders as SPAC it will delay shipment of the order. Please note, parts will not be shipped overnight. Plan accordingly for transit time to reach your facility.

Note: * The new HD part numbers 84594241 (air bag kit) and 84594242 (bracket) must ONLY be submitted with the new labor code (9105717) AND with job card date of June 28, 2021 or later to avoid claim rejection. Vehicles repaired with the new part number 84594241 MUST have the serial number recorded when submitting the claim. Dealers submitting for the previous HD part number 84255088 with a job card date PRIOR to June 28, 2021 must use the previous labor code (9105361). Vehicles repaired with the previous part number 84255088 do not require recording of the serial number when submitting the claim.

Used Inflator Return Instructions

Note: Do not discard or destroy the box containing the new passenger airbag inflator, it will be needed to return the used airbag inflator. Refer to the instructions enclosed in the service kit box for return instructions. The US return instructions packaged in the box refer to the original recall involving these parts (49151 and 49152). Disregard this reference, these are the correct return instructions for the current recall.

Note: Return instructions are only applicable to the United States and Canada at this time. International dealers should disregard the instructions enclosed with the replacement airbag inflator. Dealers outside these markets should securely store used airbag inflators until final return instructions are provided in the future.

Caution: DO NOT deploy any airbag inflator.

Undeployed airbag inflators are regulated as dangerous goods and all service agents must follow all applicable International, Federal, State, Provincial, and/or Local laws when preparing dangerous goods shipments including but not limited to classification, packaging, marking, labeling, and shipping dangerous goods.

Warranty Information

Labor Operation	Description	Labor Time	Trans. Type	Net Item
9105803**	Replace Dual Stage Front Passenger Airbag Inflator	0.7	ZFAT	*
	Cadillac Escalade, Escalade ESV, Escalade EXT; Chevrolet	-		
	Avalanche, Silverado 1500, Suburban, Tahoe; GMC Sierra 1500,	-		
	Yukon, Yukon XL	-		
	Add: SLT Trim Level – GMC Only	0.1		
9105717**	Add: LTZ Trim Level – Chevrolet Only	0.1	ZFAT	*
	Add: Avalanche, Suburban, Tahoe, Yukon	0.1		
	Replace Single Stage (Heavy-Duty Pickup Truck Only) Front	0.7		
	Passenger Airbag Inflator	-		
Chevrolet Silverado and GMC Sierra 2500/3500 HD		-		
	Add: SLT Trim Level – GMC Only	0.1		
	Add: LTZ Trim Level – Chevrolet Only	0.1		

Product Safety Recall

N212328800 Front Passenger Airbag Takata Inflator - Priority Group 10



Serial Number Recording for All Airbag Inflator Replacements:

Labour Time [\[Top\]](#)

Labour Operation Code:

Module Replacement

Additional labour op code information:

Base Labour Time:

Set Up Time: Additional Time: Paint Mix Time:

Administration Time: Diagnosis Time:

Other Labor Operation Code Other Labour Time

5844317

IMPORTANT: (TECHNICIAN and WARRANTY ADMINISTRATOR) REQUIREMENT FOR THE REPLACEMENT AIRBAG INFLATOR. The replacement airbag inflator serial number must be captured by the technician and recorded on the job card beginning June 28, 2021. The Warranty Administrator MUST enter the replacement airbag inflator serial number in GWM (Global Warranty Management) or in DMS (Dealer Management System). Enter the serial number of the replacement airbag inflator in the 'Labor Operation Dependency Code' field (1) per the screen above. Failure to enter this serial number will cause the claim to reject.

- * Submit a \$20.00 administrative allowance for return of the used front passenger airbag inflator assembly (document preparation and packaging). Add this amount in the Administrative Allowance Net Item field when submitting the repair transaction.
For Export Only – Submit an administrative allowance for return of the used front passenger airbag inflator assembly (document preparation and packaging). Add 0.2 in the labor time field when submitting the repair transaction.
- ** Involved vehicle owners are eligible for courtesy transportation while their vehicle is being repaired. If courtesy transportation is required, add the actual cost in the appropriate Net Item field when submitting the repair transaction. Refer to GM Warranty Administration Bulletin 18-NA-094 for Courtesy Transportation Program guidelines.

Special Tools

Dealers must use the airbag mounting bracket, shown below, to replace the front passenger airbag inflator. As of December 31, 2015, all U.S. dealers have been shipped the airbag mounting bracket at no charge through Bosch Automotive Service Solutions. The Bosch tool number is EL-51377. If your dealership does not have the airbag mounting bracket, do not attempt to perform this service procedure and immediately contact **1-800-GM-TOOLS** for assistance. Attempting to replace the front passenger airbag inflator without using the bracket may pose a safety risk for the technician and anyone else in the area.

Product Safety Recall

N212328800 Front Passenger Airbag Takata Inflator

- Priority Group 10

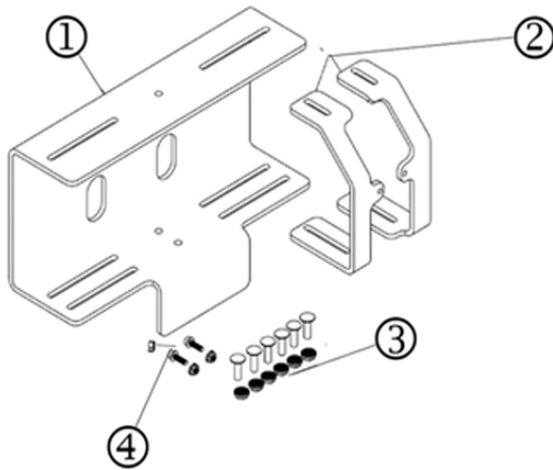

4006668

(1) Mounting Bracket (2) Support Bars (3) Support Bar Hardware (4) Airbag Mounting Hardware.

Service Procedure

Important: Dealers are required to use the airbag mounting bracket to perform the front passenger airbag inflator replacement procedure. If this special tool is not available, do not proceed with this repair.

Warning: If an airbag system is not handled using proper procedures and methods, it may be activated accidentally during work resulting in a life-threatening serious accident. If the service procedure is not performed correctly, the system may fail to activate when needed. Be sure to perform the proper work safely and according to the instructions provided below:

1. Eliminate Static Electricity. Before start of work, touch a metallic portion of the vehicle with a bare hand to discharge static electricity charged on your body.
2. DO NOT Measure Resistance. DO NOT measure resistance of airbag components. Measuring current of a circuit tester may cause accidental activation.
3. Handle the airbag properly. If an inflator is dropped, replace it with a NEW inflator.
4. DO NOT allow foreign objects near the airbag. Collect and account for all removed nuts/bolts to prevent them from landing in the airbag assembly. Any foreign objects in the airbag assembly may cause damage or injury if the airbag is activated.
5. Wear protective equipment. Always wear appropriate protective equipment when working on the airbag.

Remove the instrument panel passenger airbag assembly from the vehicle and place on bench. Refer to *Airbag Instrument Panel Module Replacement* in SI.

Product Safety Recall

N212328800 Front Passenger Airbag Takata Inflator

- Priority Group 10

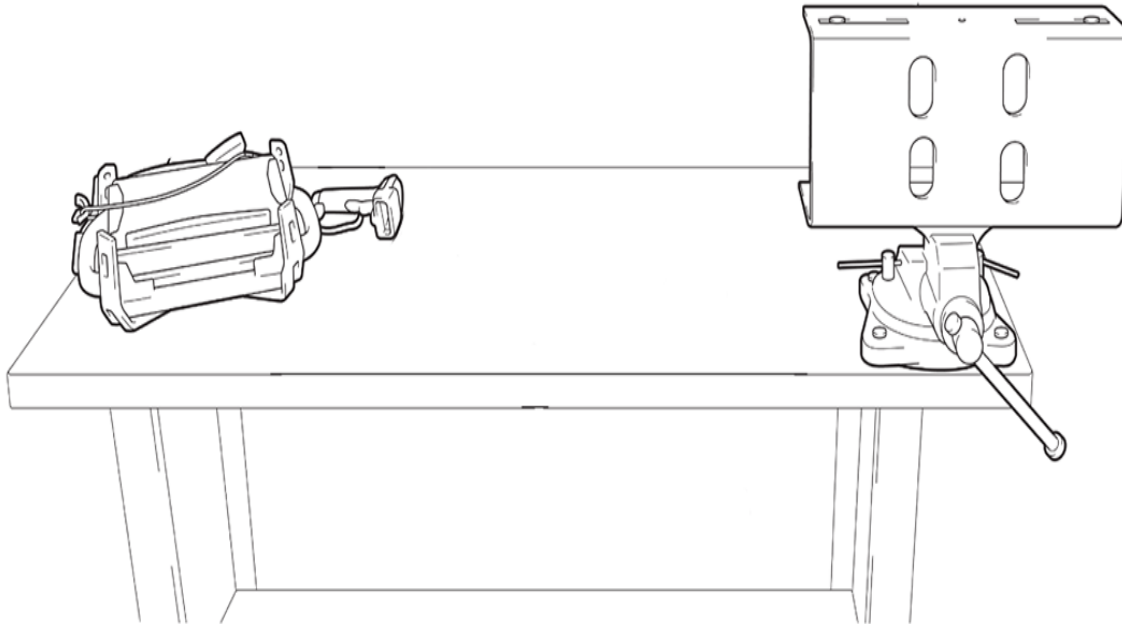

3607819

Danger: To avoid personal injury or death, it is critical to use an airbag module bracket when replacing an inflator module. Carefully read and follow the instructions below:

1. Confirm the bracket assembly is installed securely in the vise.
2. Confirm there are no loose objects or people exposed to the back side of the bracket for safety in the unlikely event of airbag deployment due to improper work procedures. The airbag is NOT being replaced due to an inadvertent deployment concern.
3. Confirm that no objects, tools or people are within 3 feet (1 meter) of the back side of the bracket.
4. Confirm that no objects, tools or people are within 2 feet (0.6 meters) of the sides of the bracket.
5. BEFORE starting work and periodically while working on the airbag module, touch a metallic part of the work bench to discharge static electricity in the body.

Airbag Removal from Vehicle and Installing in Mounting Bracket (Use with All Vehicles)

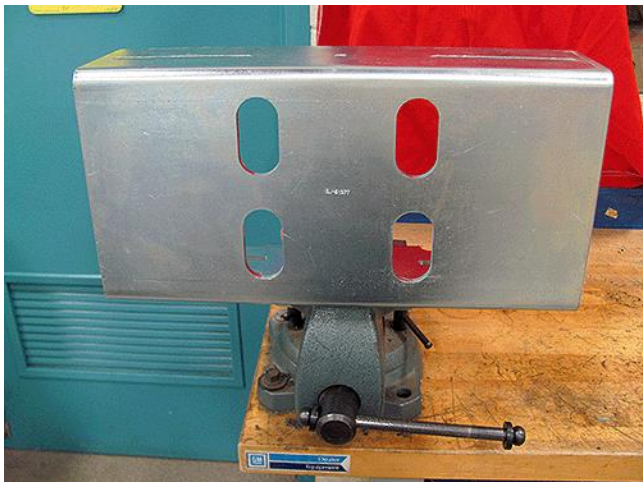

4664047

1. Mount the airbag module bracket securely in a vise.

Product Safety Recall

N212328800 Front Passenger Airbag Takata Inflator

- Priority Group 10

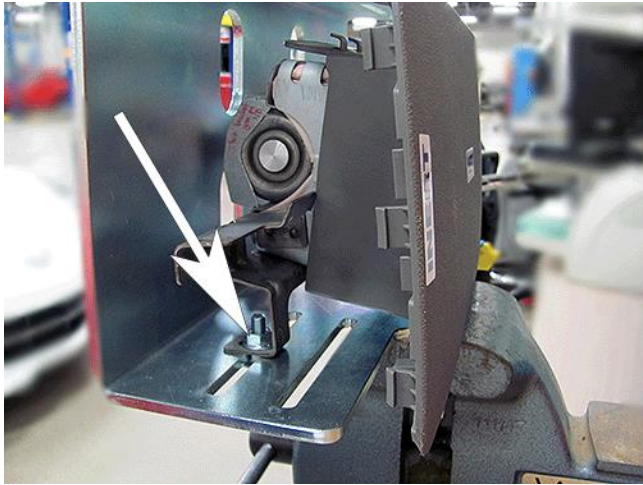

4664048

- Using the hardware kit supplied with the module bracket, loosely mount the airbag assembly to the bracket using two nuts and bolts.

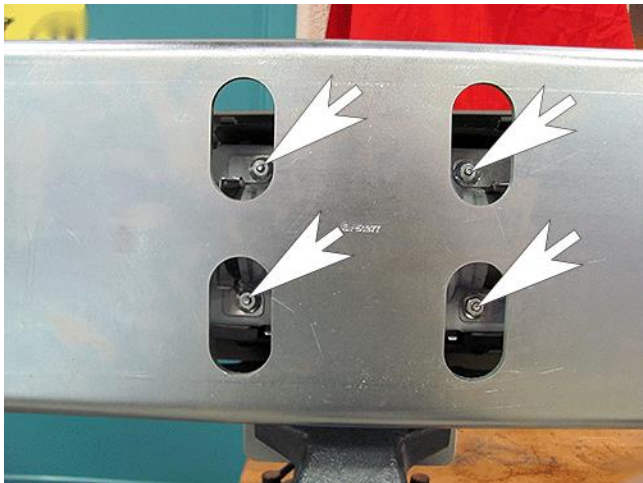

4664049

- Position the airbag assembly so that all four stopper plate nuts can be removed through the access holes.

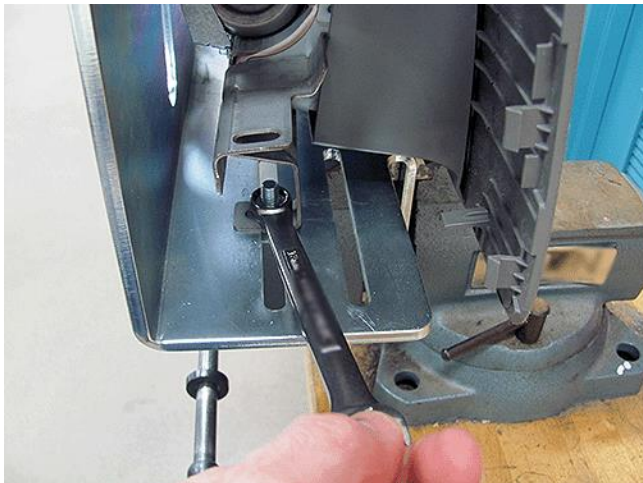

4664050

- Tighten the two fasteners that attach the airbag assembly to the module bracket.
- Confirm the following steps have been completed BEFORE proceeding to the next step:
 - The mounting bracket is secure in the vise.

Product Safety Recall

N212328800 Front Passenger Airbag Takata Inflator

- Priority Group 10



- The airbag assembly is secured to the bracket.



3607909

Danger: To avoid personal injury, *ALWAYS* keep as much of your body as possible in front of the bracket when working on the airbag assembly. Remember to periodically touch a metallic part of the vehicle or work bench to discharge static electricity in the body. **DO NOT** use power tools when performing the inflator removal/reinstallation steps.

Dual Stage Front Passenger Airbag (All Light Duty Pickup Trucks and LD/HD Utility Models)

Create a short circuit before disconnecting the inflator wires.



5680363

1. Peel the yellow tape off of the wire harness near the connector. **DO NOT** use a knife or sharp tool to remove the yellow tape.

Product Safety Recall

N212328800 Front Passenger Airbag Takata Inflator
- Priority Group 10

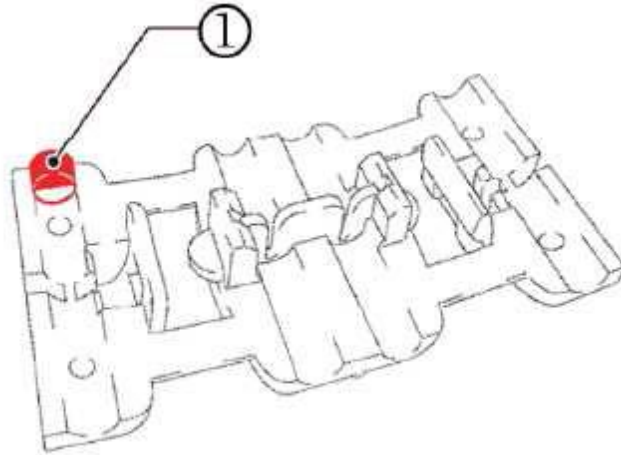

5680722

2. Locate the red plastic “Electro Tap” from the service kit. If required, remove the small tab from the electro tap as shown (1).

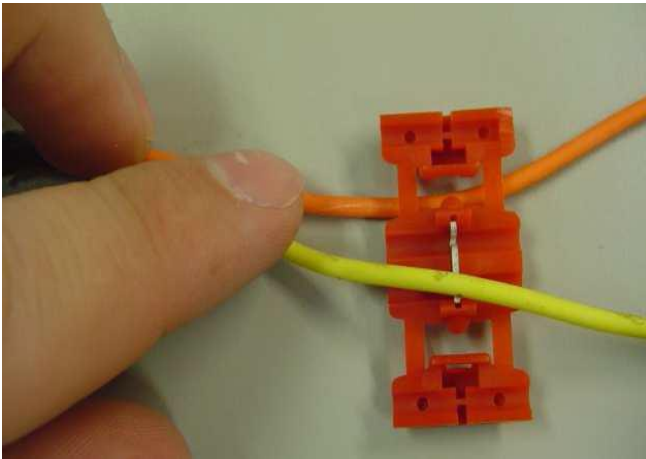

5680660

3. Locate the yellow wire and place it in the electro tap.

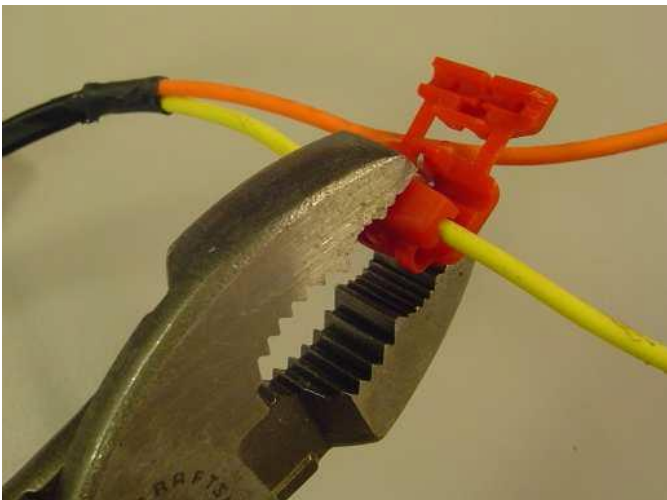

5680663

4. Use pliers to firmly close the electro tap on the **yellow wire** until an audible “click” is heard confirming the installation.

Product Safety Recall

N212328800 Front Passenger Airbag Takata Inflator
- Priority Group 10

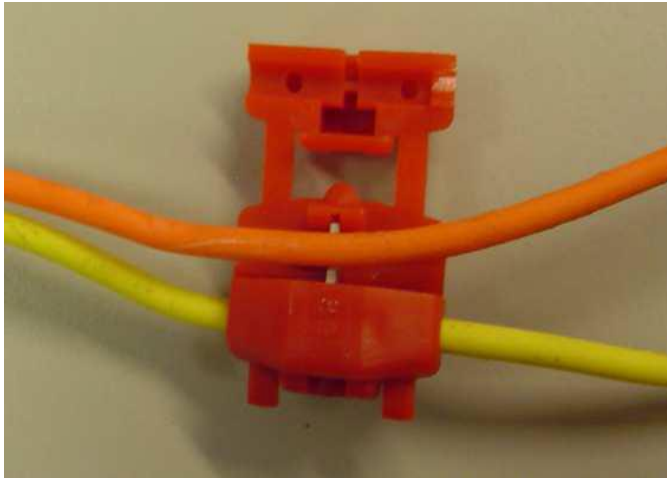

5680664

5. Locate the orange wire and place it in the electro tap.
6. Use pliers to firmly close the electro tap on the **orange wire** until an audible “click” is heard confirming the installation.

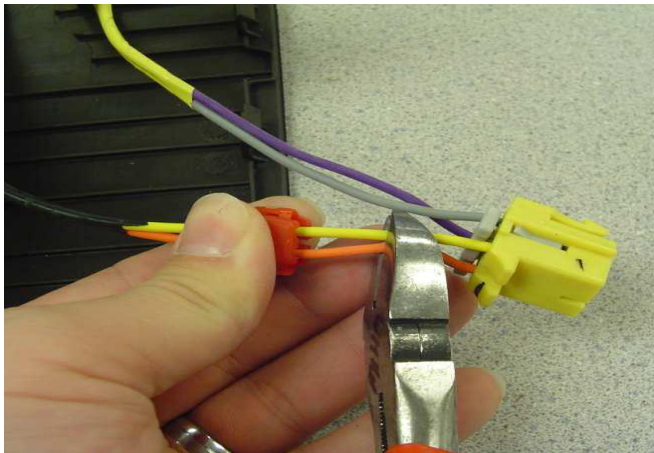

5680666

7. Place wire cutters on the connector side of the electro tap and cut the wires as shown.



4664052

8. Use the access holes in the bracket to loosen and remove the four self-locking nuts, **do not use power tools to remove the nuts**. Discard the nuts, they will not be reused.

Product Safety Recall

N212328800 Front Passenger Airbag Takata Inflator
- Priority Group 10

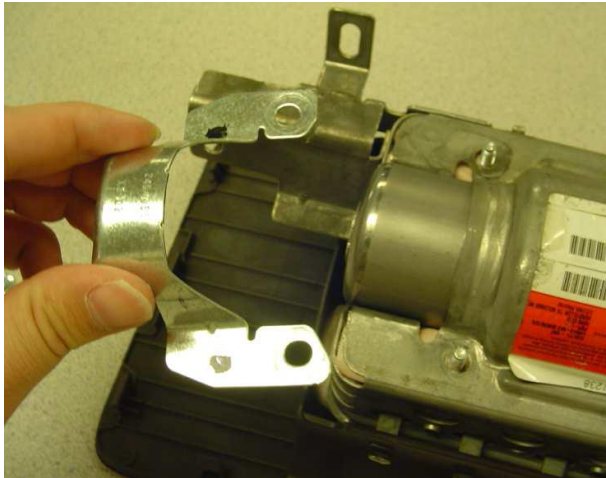

5680667

9. Remove the stopper plate (bracket).

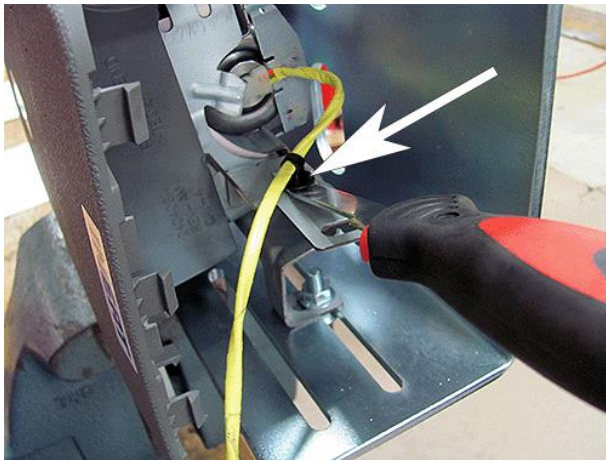

4664053

10. Disengage the wire harness locator from the housing.

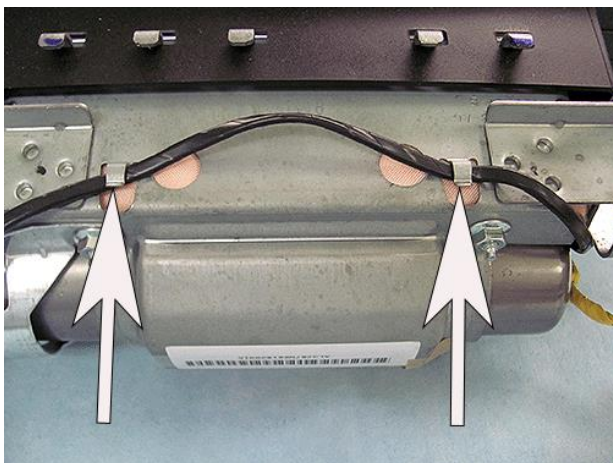

5680364

11. Remove the black taped wire from the housing tabs. The wire harness is now fully disconnected from the housing.

Product Safety Recall

N212328800 Front Passenger Airbag Takata Inflator
- Priority Group 10

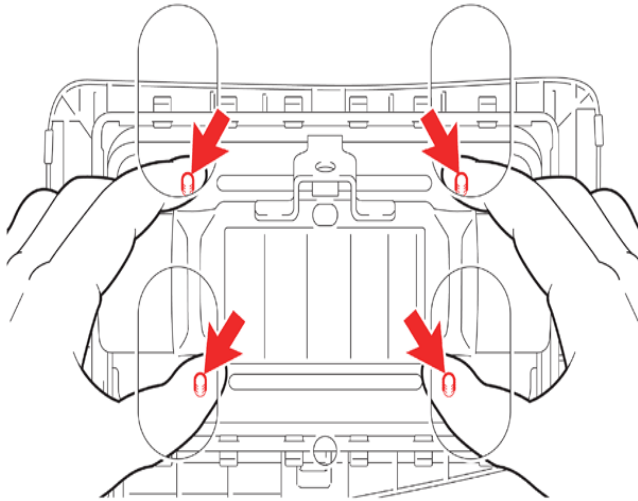

3607857

12. Gently push in the 4 studs to loosen the inflator for removal.

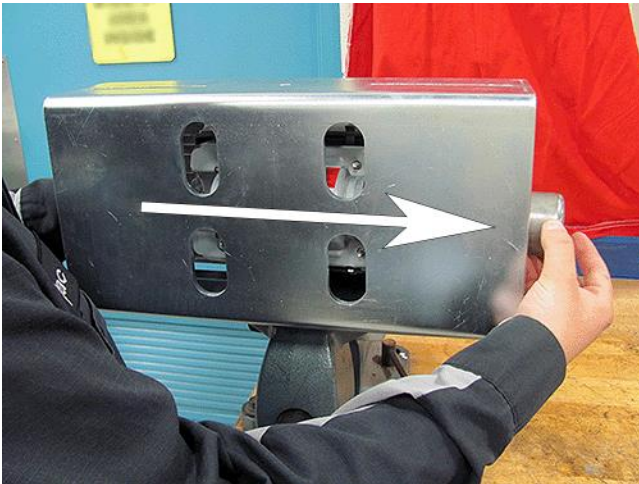

4664060

13. Remove the inflator from the housing, slide the inflator to the right.



4664063

14. Put a mark on the removed inflator and store it in the provided replacement part box. Refer to the instructions that were included with the new inflator module kit.

Product Safety Recall

N212328800 Front Passenger Airbag Takata Inflator
- Priority Group 10



5845761

15. Record the serial number of the new (replacement) inflator from the service kit on the job card.



5844318

16. Record the serial number of the used inflator that is being returned on the job card.
17. Inspect the new inflator for the following two conditions:

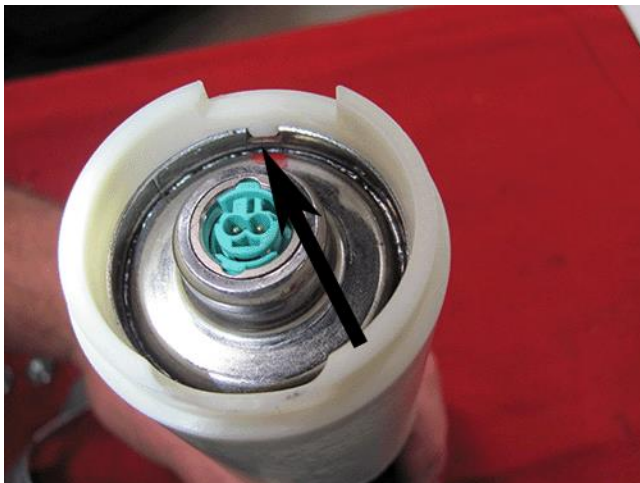

5680402

- Ensure the tab on the white end cap is aligned with the notch in the inflator.

Product Safety Recall

N212328800 Front Passenger Airbag Takata Inflator

- Priority Group 10

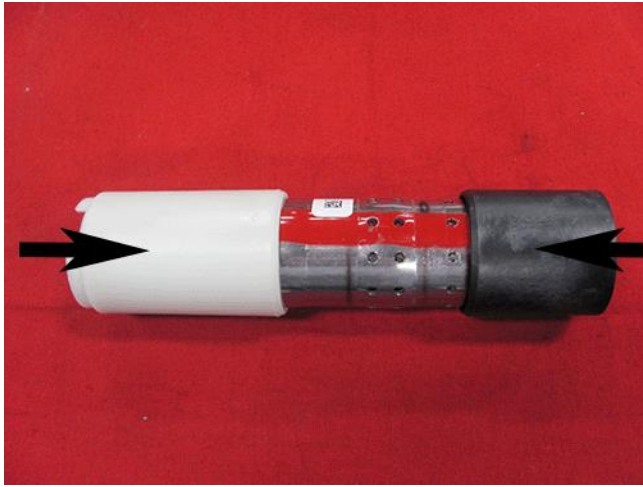

5680403

- Ensure both end caps are fully seated onto the inflator.

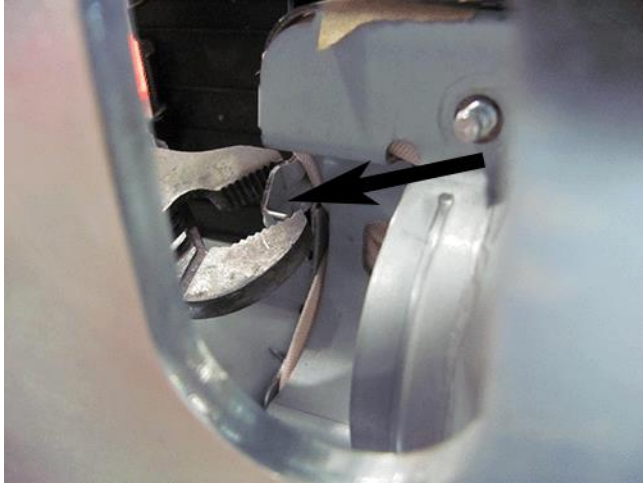

5680405

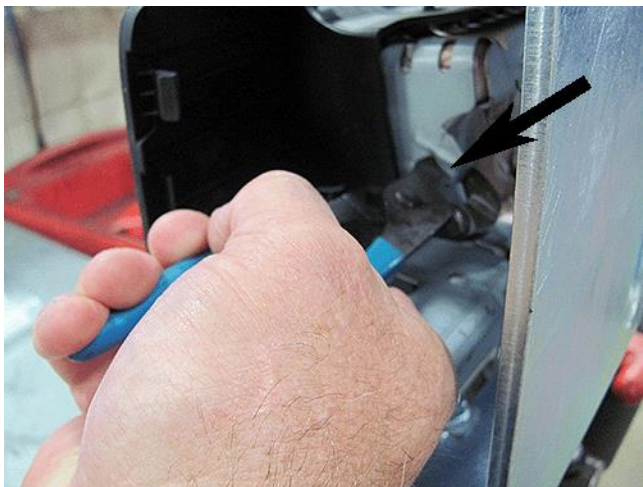

5680406

Product Safety Recall

N212328800 Front Passenger Airbag Takata Inflator
- Priority Group 10

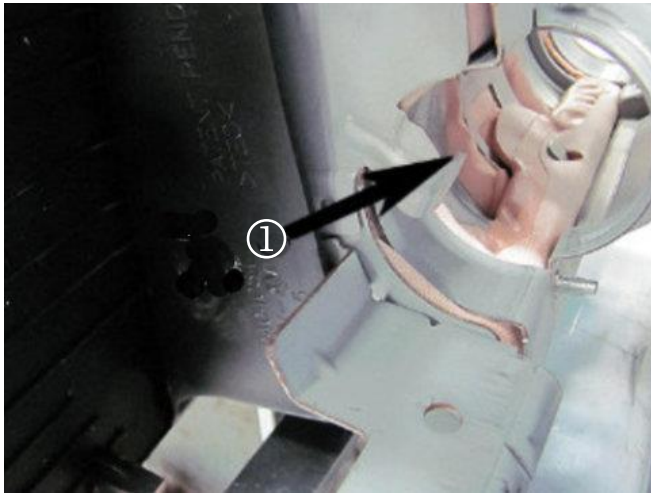

5845805

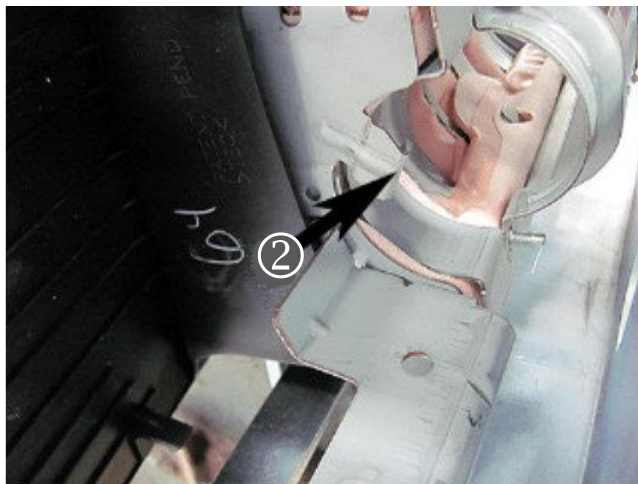

5845806

18. Using a small pair of slip joint pliers, bend the alignment tab on the airbag inward from a 90 Deg. angle (1) to a 45 Deg. angle (2).

Note: Only the small return tab should be bent. Take care to not bend any other portion of the orientation tab.

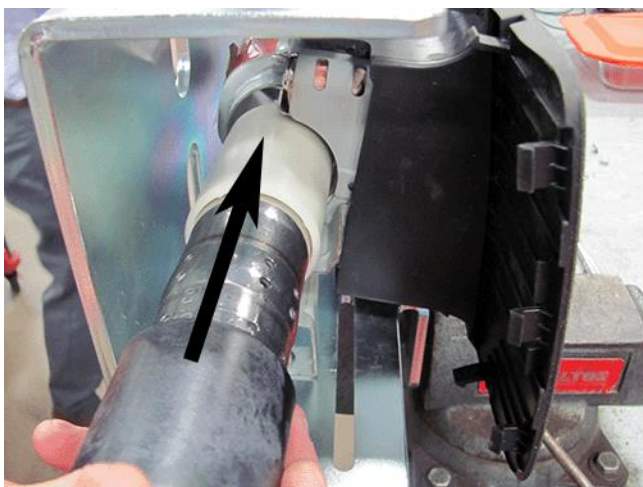

5680409

19. Slide the new inflator into the housing with the white end cap first.

Product Safety Recall

N212328800 Front Passenger Airbag Takata Inflator

- Priority Group 10

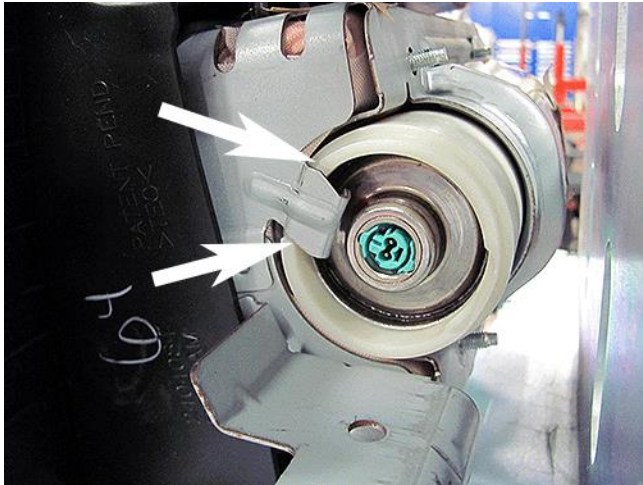

5680411

20. Rotate the inflator until the notch in the white end cap aligns with the alignment tab.



5680668

21. Place the stopper plate onto the studs as shown.

22. Loosely hand start the 4 new nuts on the studs.

Product Safety Recall

N212328800 Front Passenger Airbag Takata Inflator

- Priority Group 10

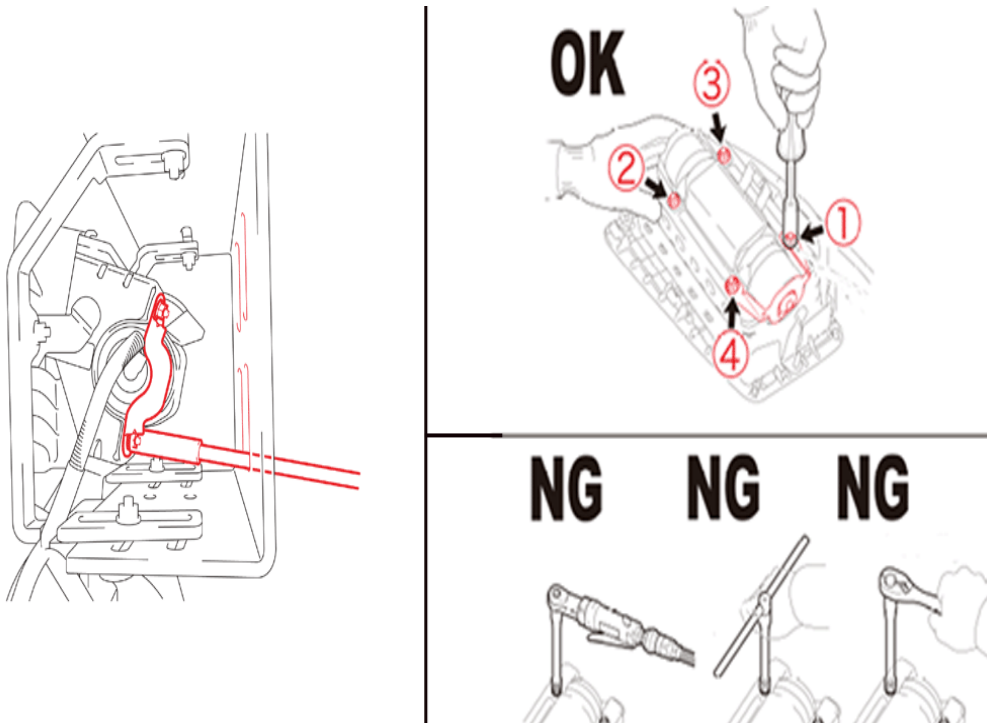

3610416

23. Tighten four (4) *NEW* plate nuts evenly in several increments in the order shown in the illustration using a 10-mm socket driver while pushing on the inflator against the alignment tab.

Note: The inflator should be netted out against the alignment tab prior to tightening the nuts. You will encounter some resistance during tightening because these nuts are self-locking nuts. **Torque Specification: 6.5 Nm (57 in-lb).**

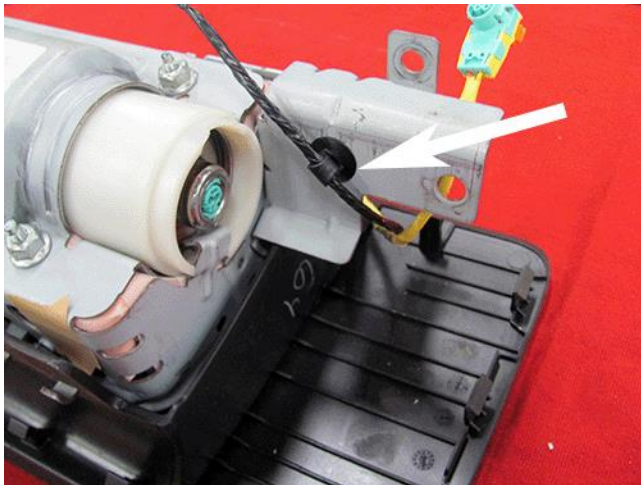

5680514

24. Install the wire harness locator to the housing.

Product Safety Recall

N212328800 Front Passenger Airbag Takata Inflator

- Priority Group 10

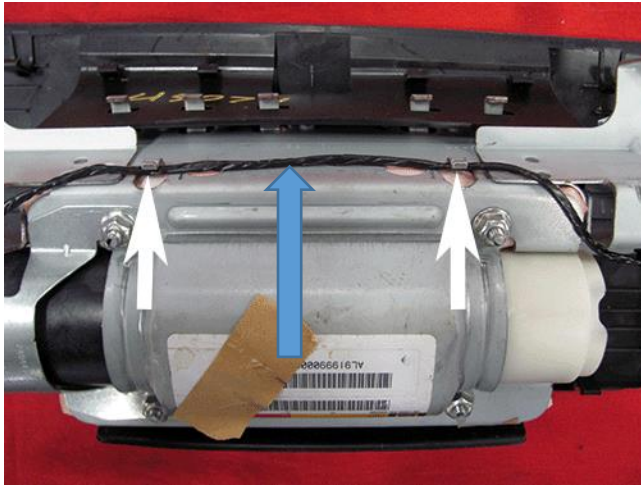

5845760

25. Press the black taped wire into the housing tabs as shown. Tape the wire harness to the metal housing in between the tabs (in the area of the blue arrow).

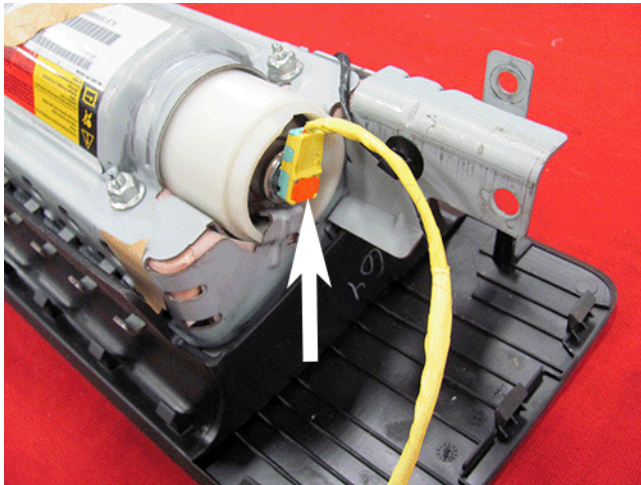

5680520

26. Install the yellow taped wire into the inflator (white cap end). Ensure the CPA is engaged.

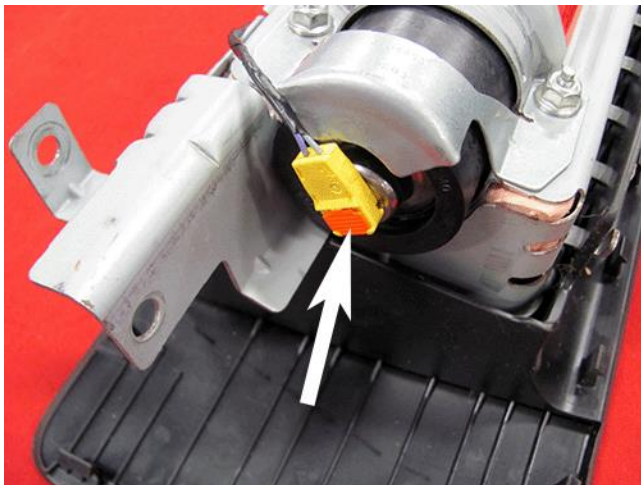

5680522

27. Install the black taped wire into the inflator (black cap end). Ensure the CPA is engaged.

Product Safety Recall

N212328800 Front Passenger Airbag Takata Inflator - Priority Group 10

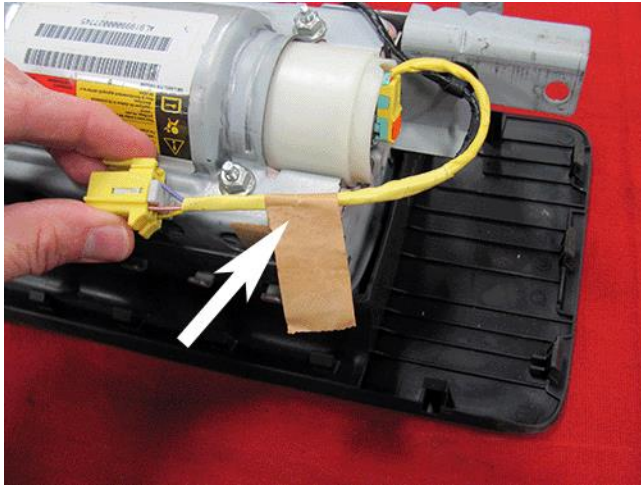

5680523

28. Apply a masking tape strip to the wire harness in the location shown below.

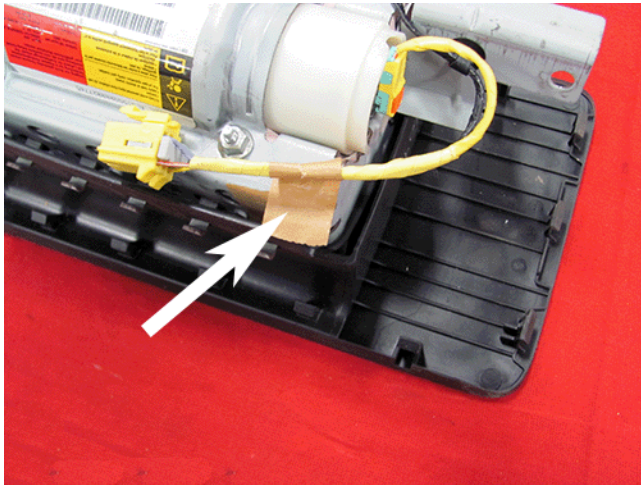

5680525

29. Adhere the tape strip and wire harness to the metal housing as shown.
30. Confirm the wire harness is in the correct orientation after taping.
31. Remove the airbag assembly from the bracket by removing the two bolts and the airbag assembly.
32. Reinstall the instrument panel passenger airbag assembly. Refer to *Airbag Instrument Panel Module Replacement* in SI.

Product Safety Recall

N212328800 Front Passenger Airbag Takata Inflator - Priority Group 10



Single Stage Takata Front Passenger Airbag (HD Pickup Only)



4664052

1. Use the access holes in the bracket to loosen and remove the four self-locking nuts, **do not use power tools to remove the nuts**. Discard the nuts, they will not be reused.

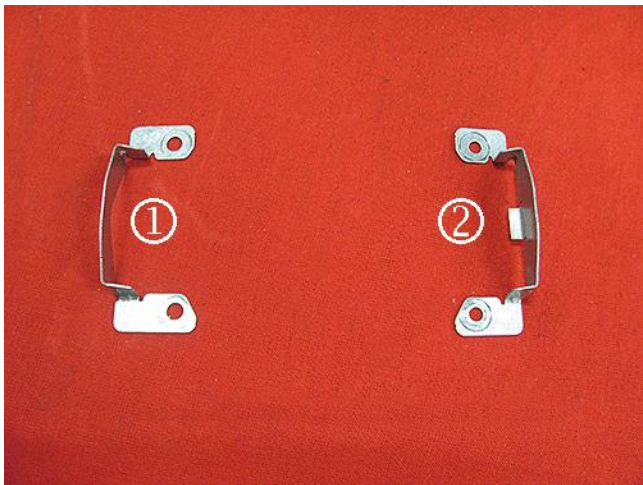

4664065

2. Remove the two stopper plates (1 and 2). Discard the stopper plates, they will not be reused.

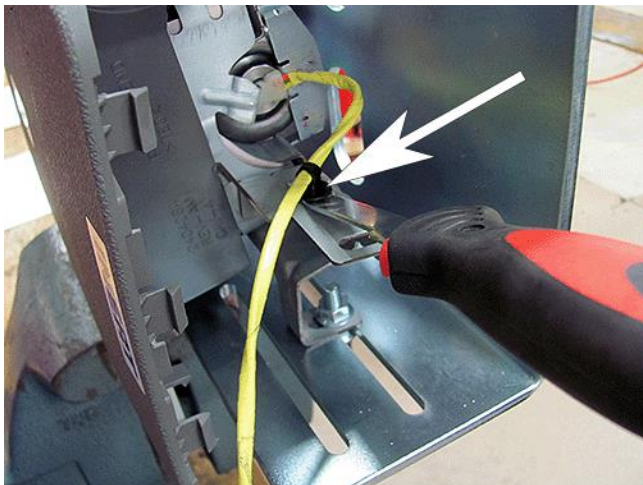

4664053

3. Disengage the wire harness locator from the housing.

Product Safety Recall

N212328800 Front Passenger Airbag Takata Inflator
- Priority Group 10

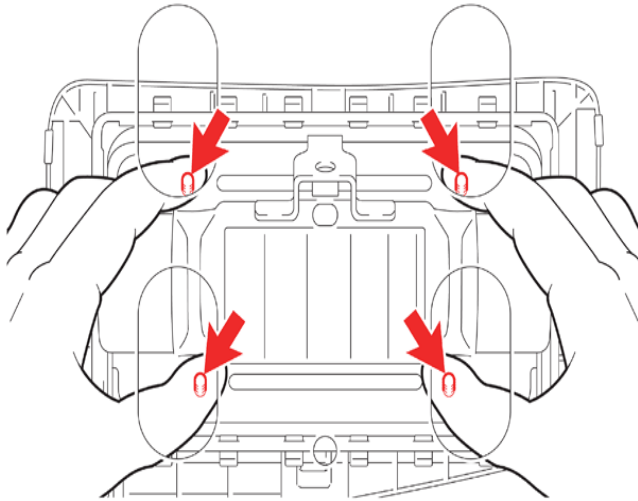

3607857

4. Gently push in the 4 studs to loosen the inflator for removal.

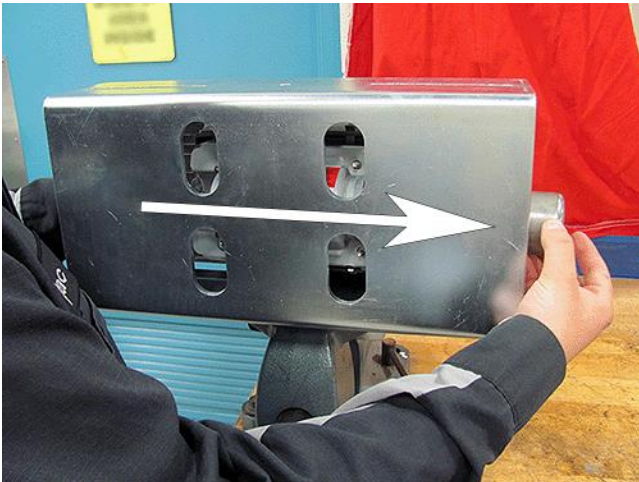

4664060

5. Remove the inflator from the housing, slide the inflator away from the harness side.



4664063

6. Put a mark on the removed inflator and store it in the replacement part box.

Product Safety Recall

N212328800 Front Passenger Airbag Takata Inflator

- Priority Group 10



5845761

7. Record the serial number of the new (replacement) inflator from the service kit on the job card.



5844318

8. Record the serial number of the used inflator that is being returned on the job card.
9. Inspect the new inflator for the following two conditions:



5680402

- Ensure the tab on the white end cap is aligned with the notch in the inflator.

Product Safety Recall

N212328800 Front Passenger Airbag Takata Inflator

- Priority Group 10

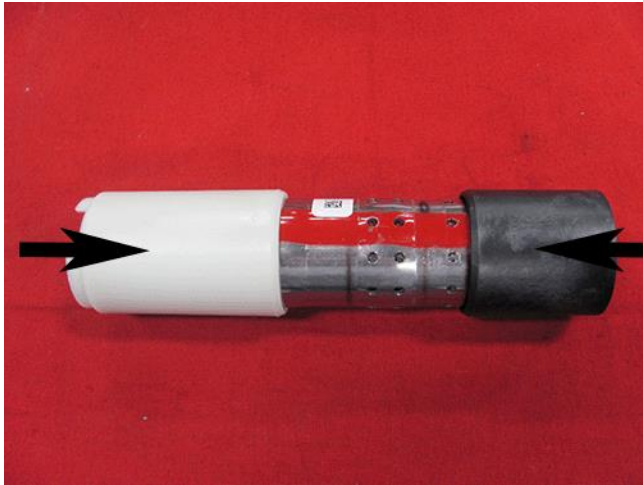

5680403

- Ensure both end caps are fully seated onto the inflator.

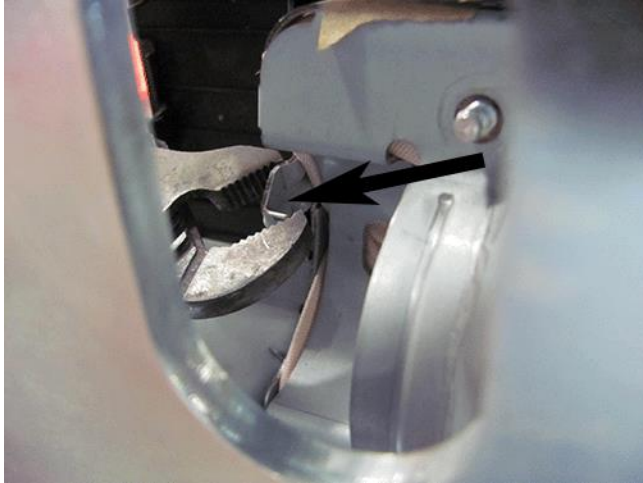

5680405

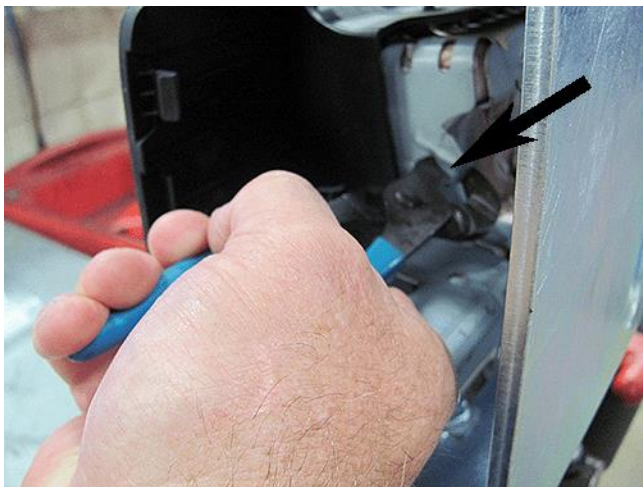

5680406

Product Safety Recall

N212328800 Front Passenger Airbag Takata Inflator

- Priority Group 10

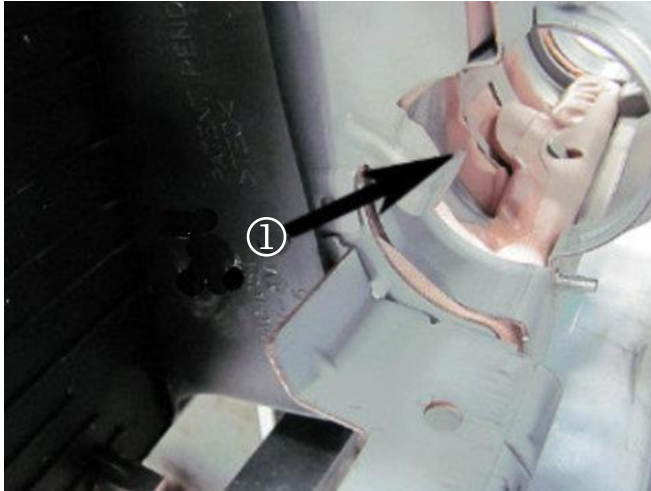

5845805

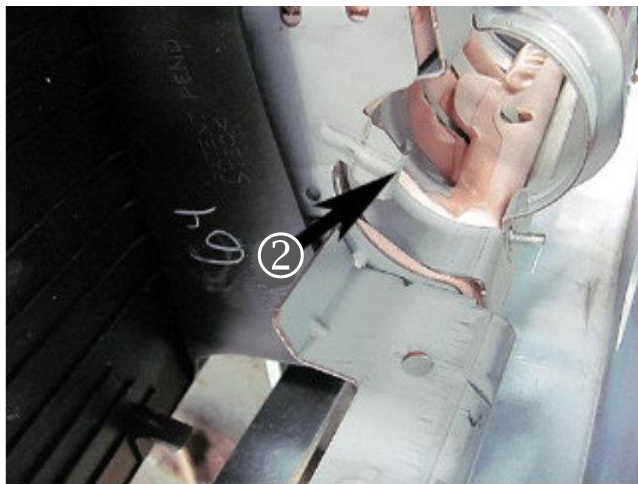

5845806

10. Using a small pair of slip joint pliers, bend the alignment tab on the airbag inward from a 90 Deg. angle (1) to a 45 Deg. angle (2).

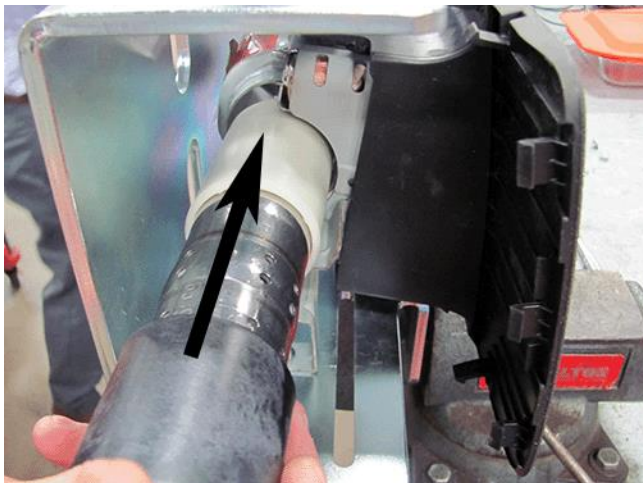

5680409

11. Carefully slide the new inflator into the airbag assembly. Ensure the inflator is installed with the harness (white end cap) end first.

Product Safety Recall

N212328800 Front Passenger Airbag Takata Inflator

- Priority Group 10

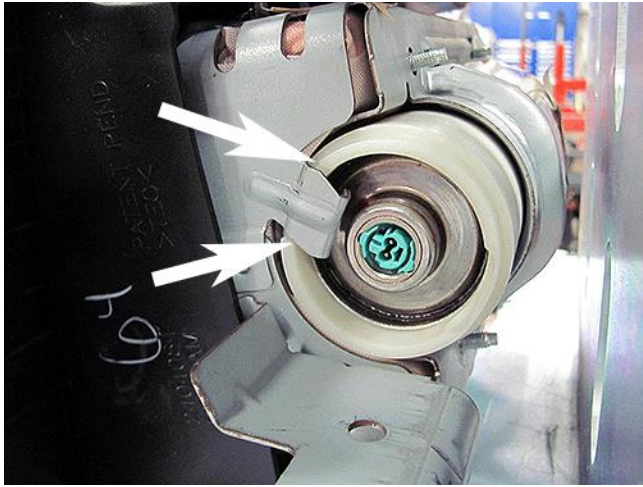

5680411

12. Rotate the inflator until the notch in the white end cap aligns with the alignment tab.

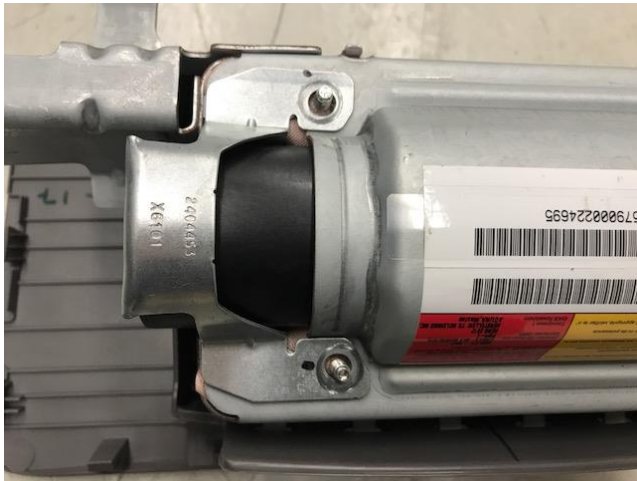

5680668

13. Place the new stopper plate (bracket) onto the studs as shown.
14. Loosely hand start the 4 new nuts onto the studs.

Product Safety Recall

N212328800 Front Passenger Airbag Takata Inflator

- Priority Group 10

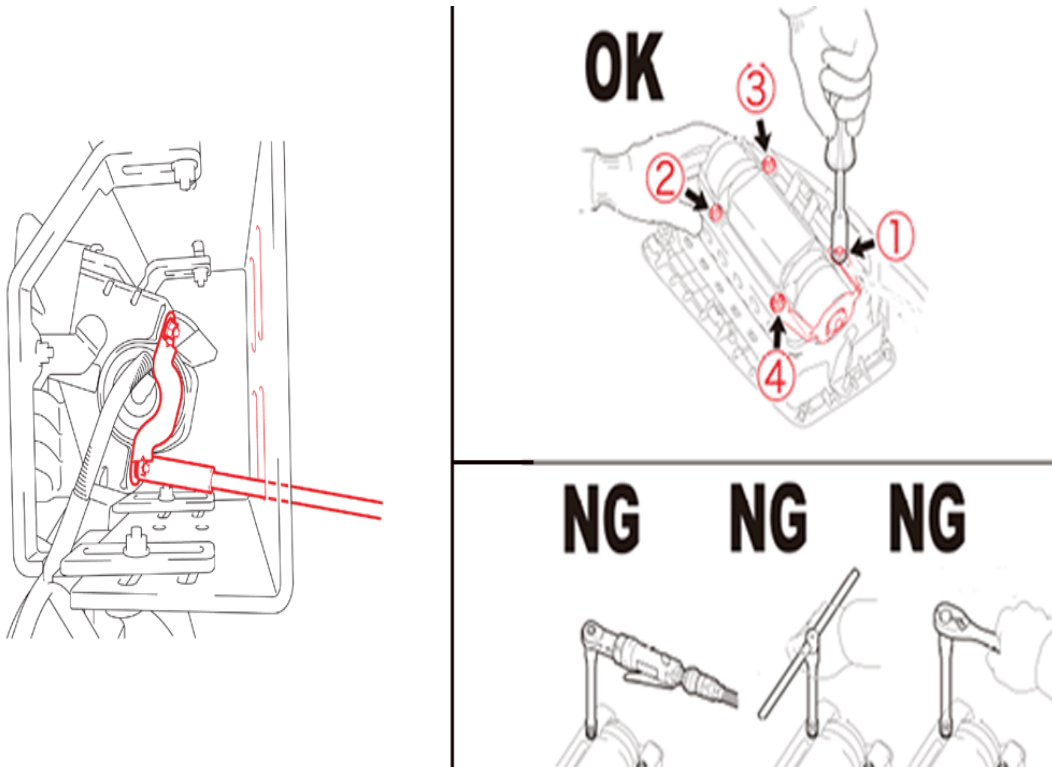

3610416

15. Tighten four (4) **NEW** plate nuts evenly in several increments in the order shown in the illustration using a 10-mm socket driver while pushing the inflator. You will encounter some resistance during tightening because these nuts are self-locking nuts. **Torque Specification: 6.5 Nm (57 in-lb).**

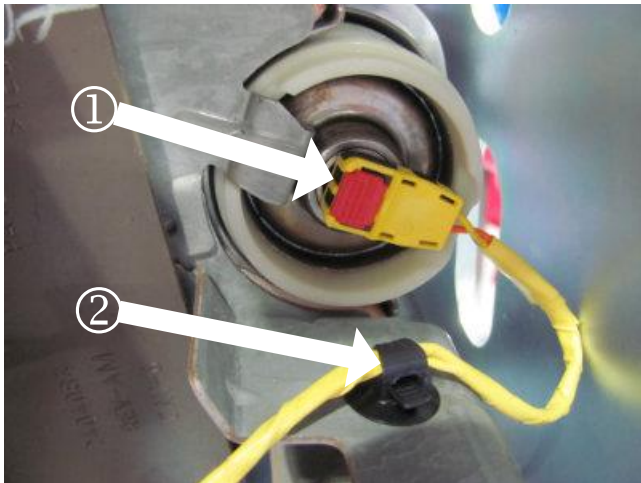

5845807

16. Connect the new yellow wiring harness to the airbag inflator, fully engage the CPA (1).
17. Install the wire harness locator to the housing (2).
18. Remove the airbag assembly from the bracket by removing the two bolts and the airbag assembly.
19. Reinstall the instrument panel passenger airbag assembly. Refer to *Airbag Instrument Panel Module Replacement* in SI.

Dealer Responsibility – For USA & Export (USA States, Territories, and Possessions)

It is a violation of Federal law for a dealer to deliver a new motor vehicle or any new or used item of motor vehicle equipment (including a tire) covered by this notification under a sale or lease until the defect or noncompliance is remedied.

Product Safety Recall

N212328800 Front Passenger Airbag Takata Inflator

- Priority Group 10



The US National Traffic and Motor Vehicle Safety Act provides that each vehicle that is subject to a recall of this type must be adequately repaired within a reasonable time after the customer has tendered it for repair. A failure to repair within sixty days after tender of a vehicle is prima facie evidence of failure to repair within a reasonable time. If the condition is not adequately repaired within a reasonable time, the customer may be entitled to an identical or reasonably equivalent vehicle at no charge or to a refund of the purchase price less a reasonable allowance for depreciation. To avoid having to provide these burdensome remedies, every effort must be made to promptly schedule an appointment with each customer and to repair their vehicle as soon as possible. In the recall notification letters, customers are told how to contact the US National Highway Traffic Safety Administration if the recall is not completed within a reasonable time.

Dealer Responsibility – All

All new, used, GM Certified Used, courtesy transportation vehicles, dealer shuttle vehicles, etc. in dealers' possession and subject to this recall must be held and inspected/repared per the service procedure of this bulletin before customers take possession of these vehicles. Involved vehicles must be held and not delivered to customers, dealer-traded, released to auction, used for demonstration, or any other purpose.

All GM Certified Used vehicles currently in the dealers' inventory within the Certified Pre-Owned Inventory System (CPOIS) will be de-certified and must be held and remedied per the service procedure in this bulletin. Upon submitting an accepted/paid warranty transaction in the Global Warranty Management (GWM) system, the vehicle can be re-certified for sale within the CPOIS system, or once again be used in the CTP program.

Dealers are to service all vehicles subject to this recall at no charge to customers, regardless of mileage, age of vehicle, or ownership, from this time forward.

Customers who have recently purchased vehicles sold from your vehicle inventory, and for which there is no customer information indicated on the dealer listing, are to be contacted by the dealer. Arrangements are to be made to make the required correction according to the instructions contained in this bulletin. Recall follow-up cards should not be used for this purpose, since the customer may not as yet have received the notification letter.

In summary, whenever a vehicle subject to this field action enters your vehicle inventory you must take the steps necessary to ensure the program correction has been made before selling the vehicle. In addition, for vehicles entering your facility for service, you are required to ensure the customer is aware of the open field action and make every reasonable effort to implement the program correction as set forth in this bulletin prior to releasing the vehicle.

Dealer Reports

For dealers with involved vehicles, a listing has been prepared and will be available through GM GlobalConnect Maxis Field Action Reports or sent directly to export dealers. The Inventory tab of the dealer reports will contain VINs that apply to this recall. This information is intended to assist dealers with the **PROMPT COMPLETION** of these vehicles. The Customer In-Service tab will contain customer names and addresses from Motor Vehicle Registration Records. The use of such motor vehicle registration data for any purpose other than follow-up necessary to complete this recall may be a violation of law in several states.

Courtesy Transportation

In conjunction with the Takata Air Bag Completion Rate Improvement Program, dealers are authorized to provide alternate transportation to affected vehicle owners while their vehicle is at a GM dealership for performance of this recall. Refer to GM Service Information Bulletin #18-NA-094 for program guidelines.

Customer Notification

USA & Canada - General Motors will notify customers of this recall on their vehicle.

Export - Letters will be sent to known owners of record located within areas covered by the US National Traffic and Motor Vehicle Safety Act.

GM bulletins are intended for use by professional technicians, NOT a "do-it-yourselfer". They are written to inform these technicians of conditions that may occur on some vehicles, or to provide information that could assist in the proper service of a vehicle. Properly trained technicians have the tools, equipment, safety instructions, and know-how to do a job properly and safely. If a condition is described, **DO NOT** assume that the bulletin applies to your vehicle, or that your vehicle will have that condition. See your dealer for information on whether your vehicle may benefit from the information.



We Support
Voluntary Technician
Certification