

Repair Procedure

Safety Recall 5321K – Multi-Model Fuel Pump May Fail – MX-5 ONLY

A. VEHICLE INSPECTION PROCEDURE

1. Verify that the vehicle is within the following ranges:

Model	Subject VIN range	Subject production date range
2018-2019MY MX-5 (ND)	JM1ND**** J0 205791 – 206202 JM1ND**** K0 300011 – 303267	From April 5, 2018 through October 29, 2018

The asterisk symbol “*” can be any letter or number.

- If the vehicle is one of the above listed, proceed to Step 2.
- If the vehicle is not within the above ranges, return vehicle to the customer or inventory.

2. Perform a Warranty Vehicle Inquiry using your eMDCS System and inspect vehicle for Campaign Labels **Recall 5321K** attached to the vehicle’s hood. Refer to eMDCS System - Warranty Vehicle Inquiry Results table below.

NOTE: Be sure to verify Recall number as the vehicle may have multiple Recall labels.

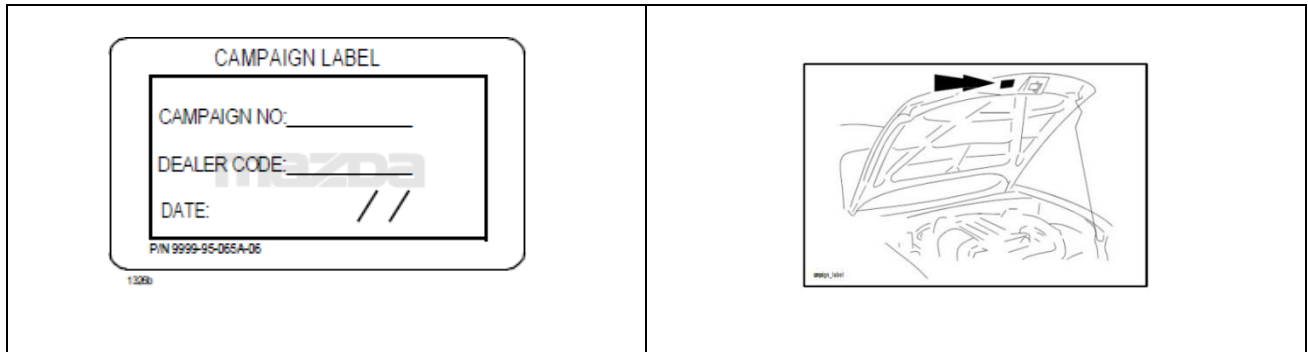

eMDCS System - Warranty Vehicle Inquiry Results:

If eMDCS displays:	Campaign Label is:	Action to perform:
If no repair date is displayed on the line with RECALL 5321K, it has not been completed on this vehicle	Present	Contact the Mazda Warranty Department at (800) 727-6626, Option 3.
	Not present	--Proceed to “REPAIR PROCEDURE”.
If repair date is displayed on the line with RECALL 5321K, it has been completed on this vehicle	Present	Return vehicle to inventory or customer.
	Not present	Complete a label and apply to vehicle's hood.
RECALL 5321K is not displayed	Does not apply	Recall does not apply to this vehicle. Return vehicle to customer.

B. Repair Procedure

Please watch the video prior to repairing:

[MX-5 Repair Video Link](#)

This repair method explains the removal of the fuel pump unit safely and most efficient way.

1. Remove the fuel pump unit from fuel tank refer to Workshop manual.
2. Pull up the fuel pump unit carefully until sender unit is appeared

Image for the part 'Sender unit' with float. Be careful the float may damage and bend easily.

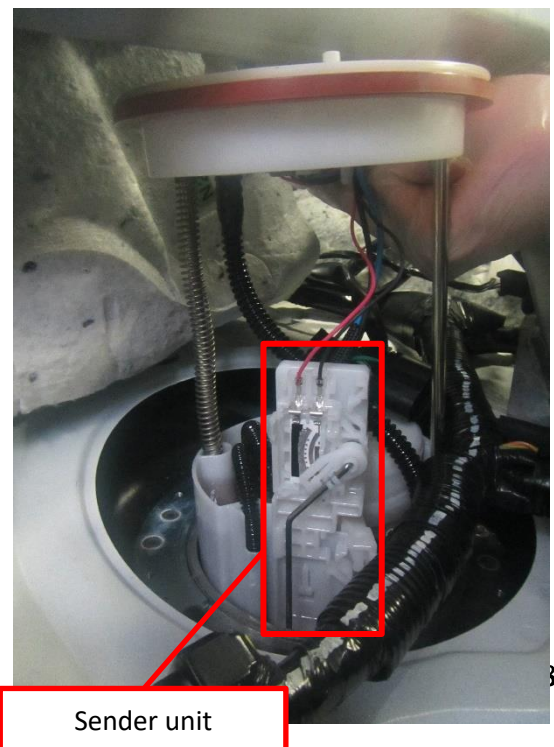
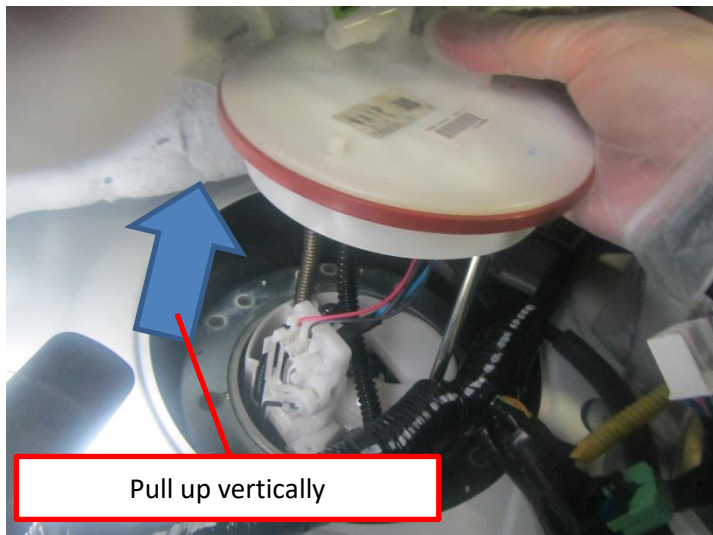
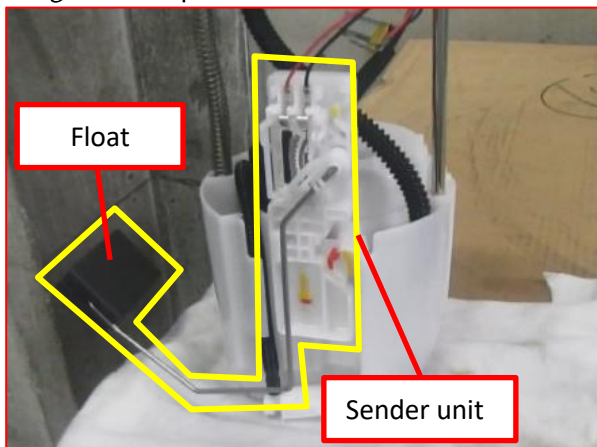

3. Remove the sender unit - refer to VIDEO on MGSS.

1, Remove the connector and harness from clamp.

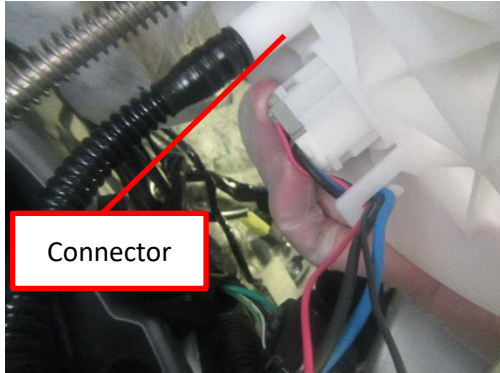

※Image for the harness with clamp.

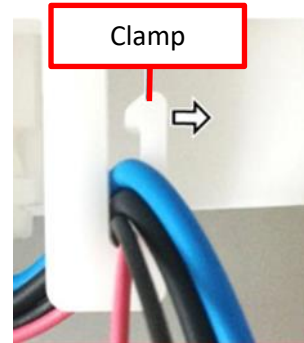

2, Release the 'Lock' then pull up the sender unit vertically.

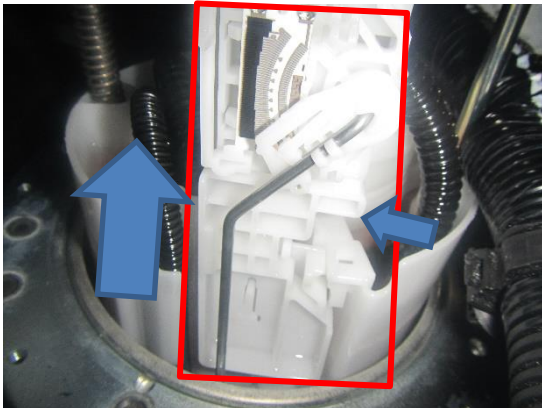

※Image for the 'Lock' position.

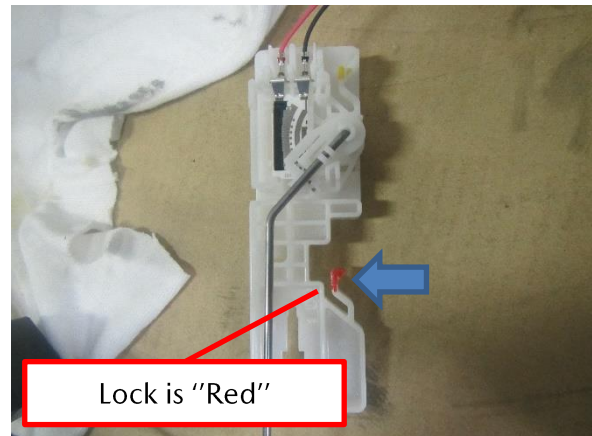

3, Hold the sender unit with harness up and go down the fuel pump unit vertically.

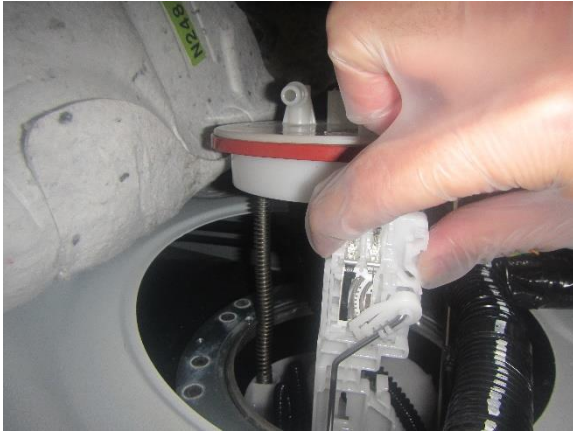

※Do not touch the sensor.

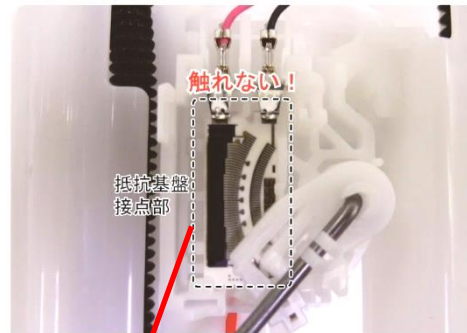

E119486

Do not touch terminals.

4, Be sure that the float part of the sender unit does not contact the fuel tank.

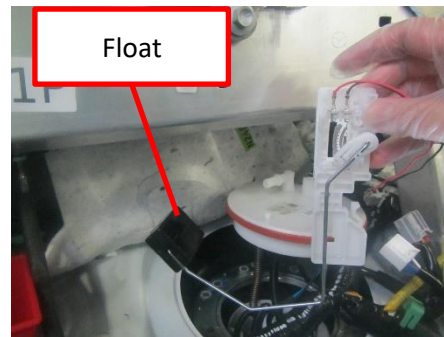

4. Remove the fuel remaining in the unit's reservoir cup with a dropper.

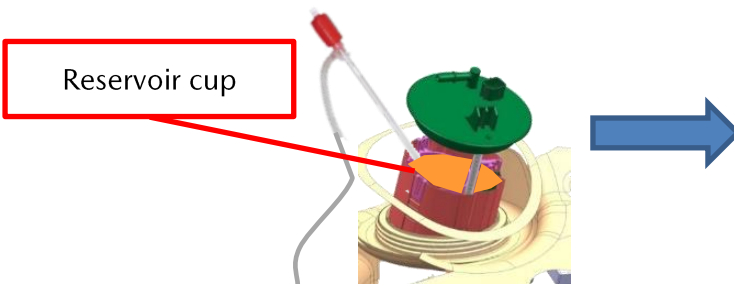

5. Remove the fuel pump unit refer to VIDEO on MGSS.

1, Lift the unit to the limit of the frame.

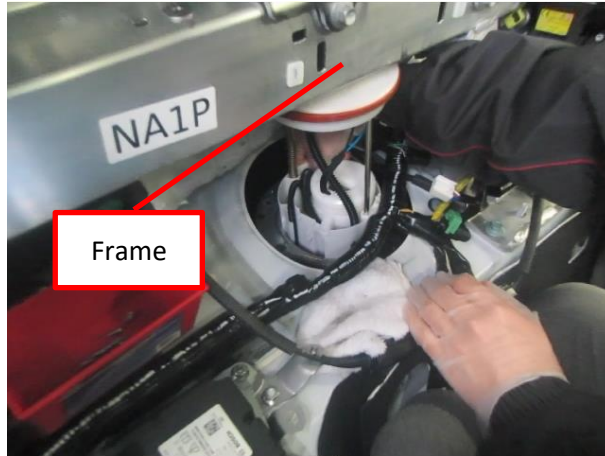

2, Apply the upper part of the unit to the frame and compress.



※Image of compression.



3, Slide the fuel pump unit as shown by the arrow to remove it from the fuel tank.

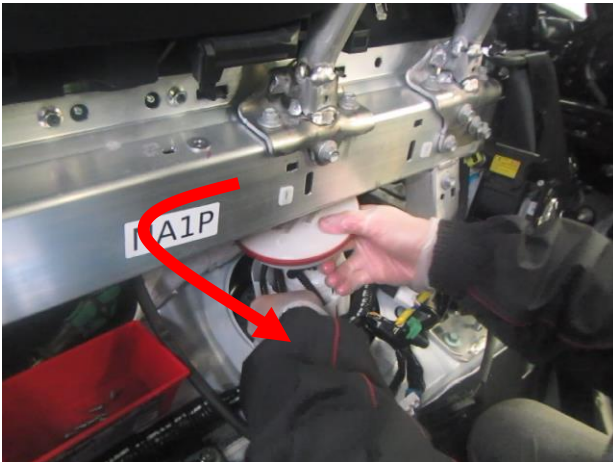

6. Proceed the removal of the fuel pump - refer to Workshop manual.
7. Install the fuel pump unit with the sender unit removed.

1, Compress the unit.



2, While compressed, push under the frame and rotate the fuel pump unit in the direction of the arrow to install the unit into the fuel tank.

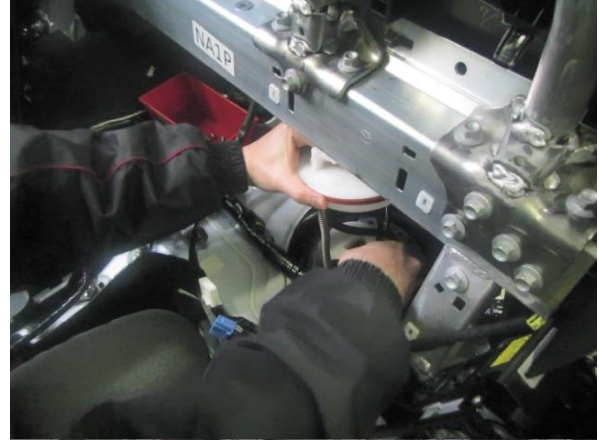
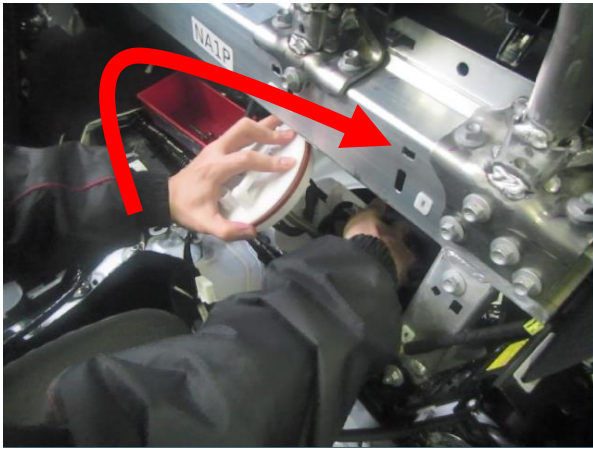

8. Install the sender unit.

1, Reinstall the sender unit inside. Make sure that the floating part does not contact the fuel tank.

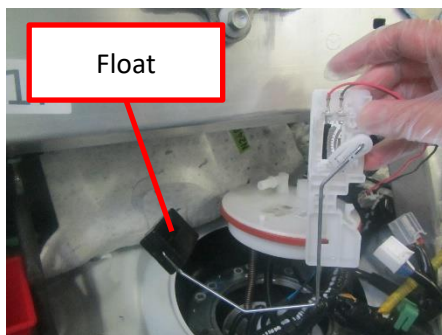

2, Hold the sender unit in your hand and slowly lower the fuel pump unit.

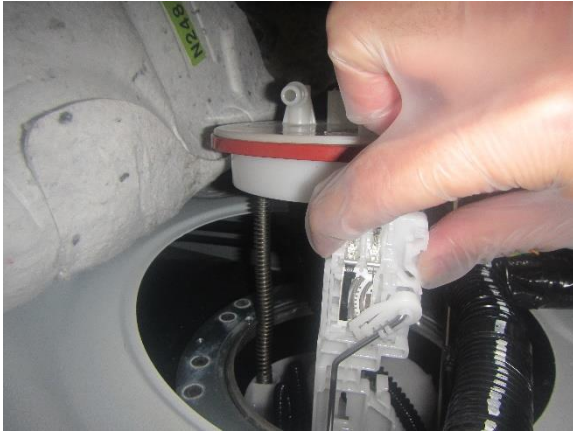

※Do not touch the sensor.

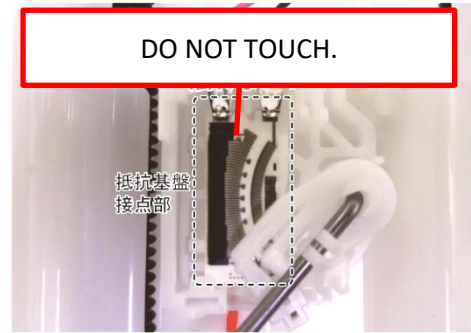

E119486

3, Push down the sender unit vertically and check the following below.

- Make sure its inserted in the groove.
- There is the clicking sound from the 'Lock'

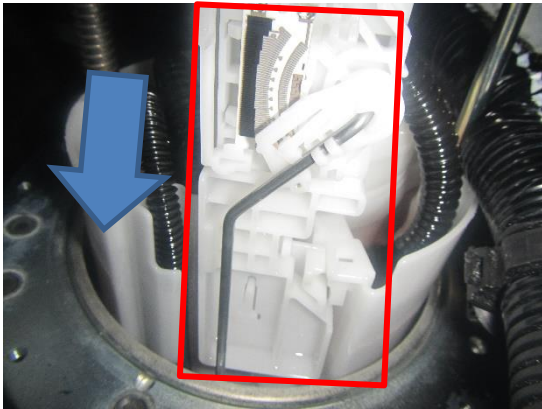

※Image of the groove and lock

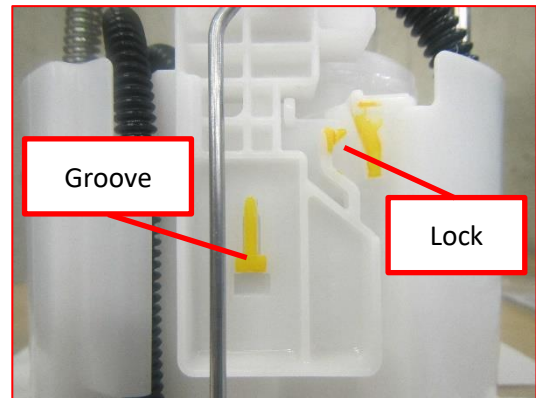

4, Install the connector and harness from clamp.

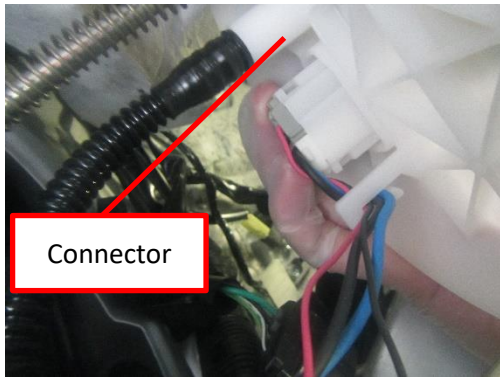

※Image for the harness with clamp.

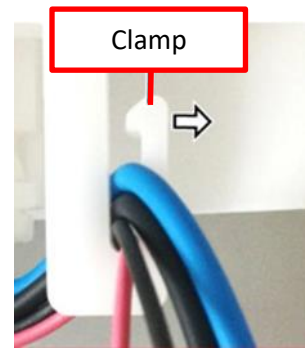

9. Install in the reverse of order of removal.

C. CAMPAIGN LABEL INSTALLATION

1. Fill out a yellow "Campaign Label" (9999-95-055A-06) with Campaign No: "5321K", your dealer code, today's date.

CAMPAIGN LABEL	
CAMPAIGN NO:	_____
DEALER CODE:	_____
DATE:	//

PIN 9999-95-055A-06

1329b

2. Affix it to the hood as shown:

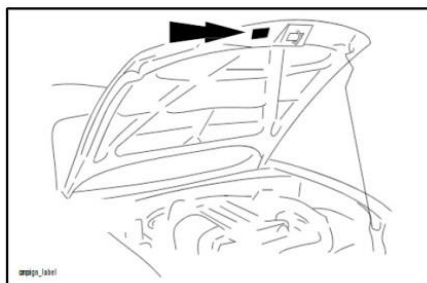

END OF REPAIR PROCEDURE