



Revision 5 March 2022

Dealer Service Instructions for:

# Safety Recall Y26 / NHTSA 21V-398

## Wheel Studs

---

**NOTE: Updated Axle Flange bolt part number chart on page 16 figure 18.**

### Remedy Available

- 2012 - 2021 (D2) Ram 3500 Pickup
- (DD) Ram 3500 Cab Chassis
- (DP) Ram 4500/5500 Cab Chassis

*NOTE: Some vehicles above may have been identified as not involved in this recall and therefore have been excluded from this recall.*

**IMPORTANT:** Some of the involved vehicles may be in dealer new vehicle inventory. Federal law requires you to complete this recall service on these vehicles before retail delivery. Dealers should also consider this requirement to apply to used vehicle inventory and should perform this recall on vehicles in for service. Involved vehicles can be determined by using the VIP inquiry process.

### Subject

The flanged wheel lug nuts on about 435,580 of the above vehicles may have been over-torqued during service to an incorrect torque specification in the Service & Owner's manuals. A yielded wheel stud may eventually break, which could lead to a wheel separating from the vehicle during operation. A wheel separating from the vehicle could cause a vehicle crash without prior warning and/or the wheel/tire could pose a risk to other vehicles or pedestrians.

**Repair**

1. Remove all four wheel and tire assemblies and inspect all wheel studs - reference section **A. Wheel Stud Inspection Procedure**.
  - a. **One (1) “Mopar Essential Tool #2077700030 - Go/No-Go Gauge” was shipped to every dealer the week of November 1, 2021.** Please ensure the gauge is kept in a secure location to be utilized for the duration of this campaign.
  - b. If there are any questions regarding delivery of the “Mopar Essential Tool #2077700030 - Go/No-Go Gauge”, contact the Mopar Essential Tool Call Center ( 1-855-298-2687 / www.moparesentialtools.com ).
  - c. Additional tools are available in limited quantities, if required. Utilize the above Mopar Essential Tool Call Center or website to submit a request.
2. If any of the wheel studs do not pass inspection – reference sections **B. Front Axle Stud Removal and Installation Procedure** or section **C. Rear Axle Stud Removal and Installation Procedure**. If all studs pass inspection, proceed to item #3.
3. Dealers are required to locate the lug nut torque specification page in the owner’s manual/user’s manual and attach a label over the existing lug nut torque specifications information page. Also insert and staple the addendum card to the same page - reference section **D. Owner’s Manual Update**.
  - a. **Process Steps to obtain Addendum Card(s) and/or Adhesive Label(s):**
    - i. Access the “**DealerCONNECT**” website.
    - ii. Select the “**Marketing**” link in the header of DealerCONNECT.
    - iii. Locate the “**Product Information**” section heading on the Marketing page.
    - iv. Select the “**Literature and Merchandising Materials**” link in the product information section.
    - v. Locate the “**Mopar**” section heading on the Literature and Merchandising Materials page.
    - vi. Select the “**Recall Labels /Cards**” link listed in the MOPAR section.
    - vii. **Select Item>Update Cart>Submit Order.**
  - b. Reference: Y26 or Y36 Addendum and Label/Sticker – they are the same.

- c. Dealers can order a minimum of 10 pieces (both labels and addendum cards) at a time and a maximum of 50 pieces. Note that labels and addendum cards should be ordered in **sets**.

Note: due to the nature of this repair, fleet certified dealers should be utilized for trucks with upfits (flat beds, etc.).

### **Parts Information**

Due to the significant quantity of vehicles and parts involved in this campaign, a STAR Case must be submitted in order to request parts.

Please access Cherwell via the Service Library link to create a STAR Case.

Please provide the VIN, Model Year and Family, Mileage, Dealer Code and failed stud location(s) and quantities (i.e. Driver Front – 2, Passenger Rear – 4). Due to the complexity of the rear stud replacement, also confirm and provide the part numbers (CSZMYXXXAA - 1) appropriately corresponding to the vehicle. Review the parts lists below and provide an accurate list of the parts required in STAR Case.

Important – When submitting a STAR Case-On the Repair Information Screen when selecting the “Next Step” – be sure to select “Y26 Wheel Stud Recall” from the list of options. This will route your ticket to the appropriate agent. **DO NOT** select “I will wait for STAR Response, or any other available option.

**NOTE:** Parts are packaged in kits. Most kits contain material to repair one or more wheels depending on the number of failed studs per truck. It is expected that the unused parts are maintained for future vehicles requiring repair. **PLEASE CHECK YOUR DEALER INVENTORY PRIOR TO PROVIDING REQUIRED PARTS LIST TO STAR.**

STAR will then verify that all of the required information is accurate, and will place the order for the appropriate parts.

Dealers must place their own axle fluid orders, if fluid is needed.

#	MY	Vehicle	Axle Sales Code	Required	Part Description	C-Kit P/N	Qty per C-Kit	Qty.
1	2012-2021	D2 DD DP	-	Failed Inspection	M14x1.50x70.00 Wheel Stud - Front	CSZMY261AA	10	<u>ONLY quantity failing inspection is needed</u> ; note: DP - 10 per wheel, Others - 8 per wheel; x 2 rear wheels
2	2012-2021	DP	-	Failed Inspection	M14x1.50x88.00 Wheel stud - Rear	CSZMY262AA	8	<u>ONLY quantity failing inspection is needed</u> ; note: DP - 10 per wheel x 2 rear wheels
3	2012-2021	D2 DD	-	Failed Inspection	M14x1.50x80.00 Wheel Stud - Rear	CSZMY263AA	5	<u>ONLY quantity failing inspection is needed</u> ; note: 8 per wheel x 2 rear wheels
4	2012-2021	D2 DD DP	-	ONLY if needed	Flanged Lug Nut	CSZMY264AA	8	<u>ONLY if needed</u> ; note: DP - 10 per wheel, Others - 8 per wheel; x 4 front/rear wheels
5A	2012-2021	D2 DD	DRX	Required for Rear Stud Replacement	BOLT, Rear Hub - Hex Flange Head, 7/16-14x35.00	CSZMY266AA	8	<u>required when any REAR studs fail inspection</u> ; note: 8 per wheel; x2 rear wheels
5B	2019-2021	DD	DRC	Required for Rear Stud Replacement	BOLT, Rear Hub - Hex Flange Head, 7/16-14x35.00	CSZMY266AA	8	<u>required when any REAR studs fail inspection</u> ; note: 8 per wheel; x2 rear wheels
5C	2012-2018	D2	DRS	Required w/ Rear Stud Replacement	BOLT, Rear Hub - Hex Flange Head, 7/16-14x35.00	CSZMY266AA	8	<u>required when any REAR studs fail inspection</u> ; note: 8 per wheel; x2 rear wheels
6A	2019-2020	D2	DRC	Required for Rear Stud Replacement	Bolt, M12 Rear hub	CSZMY267AA	8	<u>required when any REAR studs fail inspection</u> ; note: 8 per wheel; x2 rear wheels
6B	2021	D2	DRC	Required for Rear Stud Replacement	BOLT, M12 Rear Hub	CSZMY267AA	8	<u>required when any REAR studs fail inspection</u> ; note: 12 per wheel; x2 rear wheels
6C	2019-2021	DP	DRY	Required for Rear Stud Replacement	BOLT, M12 Rear Hub	CSZMY267AA	8	<u>required when any REAR studs fail inspection</u> ; note: 8 per wheel; x2 rear wheels
7	2012-2018	DP	DRT	Required w/ Rear Stud Replacement	BOLT, M12 Rear Hub	CSZMY26JAA	8	<u>required when any REAR studs fail inspection</u> ; note: 8 per wheel; x2 rear wheels
8	2012-2018	D2 DD	DRX / DRS	Required w/ Rear Stud Replacement	Seal, Wheel Bearing	CSZMY269AA	5	<u>required when any REAR studs fail inspection</u> ; note: 1 per wheel; x2 rear wheels
9A	2019-2021	D2 DD	DRX	Required for Rear Stud Replacement	Seal, Wheel Bearing	CSZMY26BAA	2	<u>required when any REAR studs fail inspection</u> ; note: 1 per wheel; x2 rear wheels
9B	2019-2021	DD	DRC	Required for Rear Stud Replacement	Seal, Wheel Bearing	CSZMY26BAA	2	<u>required when any REAR studs fail inspection</u> ; note: 1 per wheel; x2 rear wheels
10	2012-2018	DP	DRT	Required w/ Rear Stud Replacement	Seal, Wheel Bearing	CSZMY26KAA	4	<u>required when any REAR studs fail inspection</u> ; note: 1 per wheel; x2 rear wheels
11A	2019-2021	D2	DRC	Required for Rear Stud Replacement	Seal, Wheel Bearing	CSZMY26DAA	5	<u>required when any REAR studs fail inspection</u> ; note: 1 per wheel; x2 rear wheels
11B	2019-2021	DP	DRY	Required for Rear Stud Replacement	Seal, Wheel Bearing	CSZMY26DAA	5	<u>required when any REAR studs fail inspection</u> ; note: 1 per wheel; x2 rear wheels
12A	2019-2021	D2 DD	DRX	Required for Rear Stud Replacement	O-Ring, Axle Shaft	CSZMY26CAA	10	<u>required when any REAR studs fail inspection</u> ; note: 1 per wheel; x2 rear wheels
12B	2019-2021	DD	DRC	Required for Rear Stud Replacement	O-Ring, Axle Shaft	CSZMY26CAA	10	<u>required when any REAR studs fail inspection</u> ; note: 1 per wheel; x2 rear wheels
13	2019-2021	D2	DRC	Required for Rear Stud Replacement	O-Ring, Axle Shaft	CSZMY26EAA	10	<u>required when any REAR studs fail inspection</u> ; note: 1 per wheel; x2 rear wheels
14	2012-2018	D2 DD	DRX / DRS	Required w/ Rear Stud Replacement	O-Ring, Axle Shaft	CSZMY26AAA	8	<u>required when any REAR studs fail inspection</u> ; note: 1 per wheel; x2 rear wheels
15	2012-2018	DP	DRT	Required w/ Rear Stud Replacement	O-Ring, Axle Shaft	CSZMY268AA	4	<u>required when any REAR studs fail inspection</u> ; note: 1 per wheel; x2 rear wheels
16	2019-2021	DP	DRY	Required for Rear Stud Replacement	O-Ring, Axle Shaft	CSZMY26FAA	10	<u>required when any REAR studs fail inspection</u> ; note: 1 per wheel; x2 rear wheels
17	2012-2021	DP	-	Required for Rear Stud Replacement	Bolt, Rear Rotor to hub	CSZMY26GA A	10	<u>required when any REAR studs fail inspection</u> ; note: 10 per wheel; x2 rear wheels
18	2012-2021	D2 DD	-	Required for Rear Stud Replacement	Bolt, Rear Rotor to hub	CSZMY26HAA	8	<u>required when any REAR studs fail inspection</u> ; note: 8 per wheel; x2 rear wheels
19	2012-2021	DP	-	Required for Rear Stud Replacement	Bolt, Tone Ring	CSZMY265AA	5	<u>required when any REAR studs fail inspection</u> ; note: 5 per wheel; x2 rear wheels

**Parts Information [Continued]**

**Axle Fluid Part Numbers**

MY	Vehicle	Sales Code	Axle Fluid PN
2012-2018	D2,DD, DX	DRX	68210057AB
2012-2018	D2	DRS	
2012-2018	DP	DRT	68218655AA MS-9763
2019-2021	DP	DRY	68449546AA MS-A0759
2019-2021	D2,DD	DRX	
2019-2021	D2	DRC	68449547AA MS-8985

**Parts Return**

Parts returns are not required for this campaign.

**Special Tools**

**The following special tools are required to perform this repair:**

- 8677 Remover, Ball Joint
- 2067700030 Guide, Hub
- 8954A Socket, Hub Nut 6 Pin
- 2029500030 Socket, Hub Nut 9 Pin
- 2066600030 Socket, Hub Nut 12 Pin
- 2066700030 Installer, Hub Seal (12.0” Ring Gear)
- 8693 Installer, Hub Seal (11.5” Ring Gear)
- C-4171 Handle
- 2077700030 Stud Inspection Tool

## Service Procedure

### A. Wheel Stud Inspection Procedure

1. Remove the front and rear wheel and tire assemblies.
2. Using a wire brush clean the threads on all of the wheel studs.
3. Measure approximately 25mm from the axle flange surface up the stud and place a mark (Figure 3). If no measurement tool is available, use the color of the stud to identify the measurement area (Figure 2).

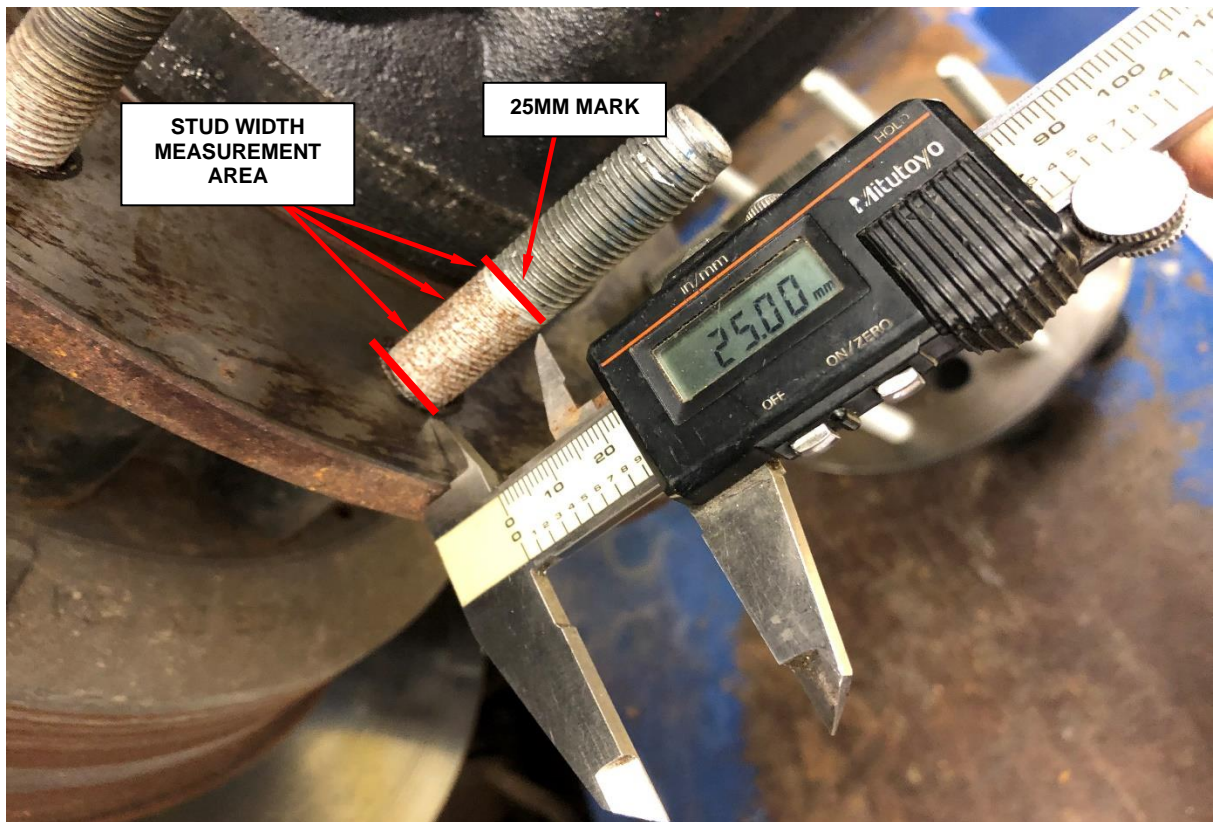
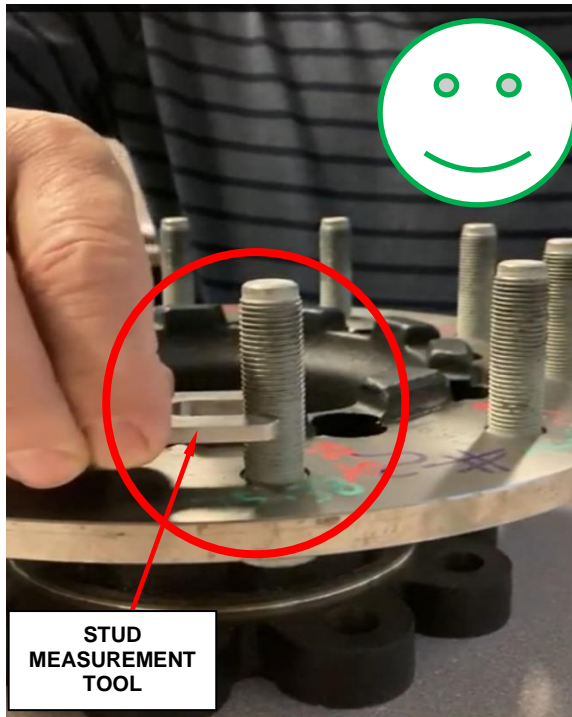
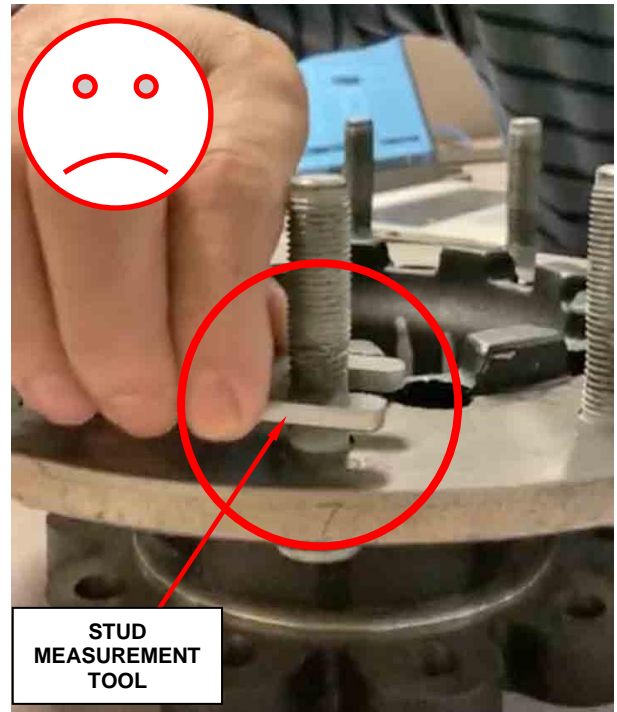

**Figure 2 Stud Measurement Area**

4. Attempt to insert the stud measurement tool in the following locations of the stud at different angles: (Figure 2).
  - a) At the base of the wheel stud.
  - b) At the center of the 25mm measurement area.
  - c) Near the 25mm mark.

**Service Procedure [Continued]**

5. Did the measurement tool insert fully into ANY of the wheel studs at all three locations? See sample illustrations below (Figure 3 and Figure 4).

**FIGURE 3 – Good Stud****Figure 4 – Bad Stud**

- If **YES** (aka. any **Bad Studs**), continue to section **B. Front Axle Stud Removal and Installation Procedure** or section **C. Rear Axle Stud Removal and Installation**, depending on failed stud wheel location.
- If **NO** (aka. **All Good Studs**), reinstall the wheel and tire assemblies by tightening all of the lug nuts to 175N·m (129ft. lbs.) and continue to section **D. Owner's Manual Update**.

**Service Procedure [Continued]****B. Front Axle Stud Removal and Installation Procedure**

1. Raise and support the vehicle.
2. Remove the front tires and wheel assemblies.
3. Attach special tool **8677** onto the front hub and press the wheel stud out of the wheel hub (Figure 5).
4. Install the **NEW** wheel stud into the flange.
5. Install three proper sized washers onto the stud, then install a lug nut with the flat side of the nut against the washer.

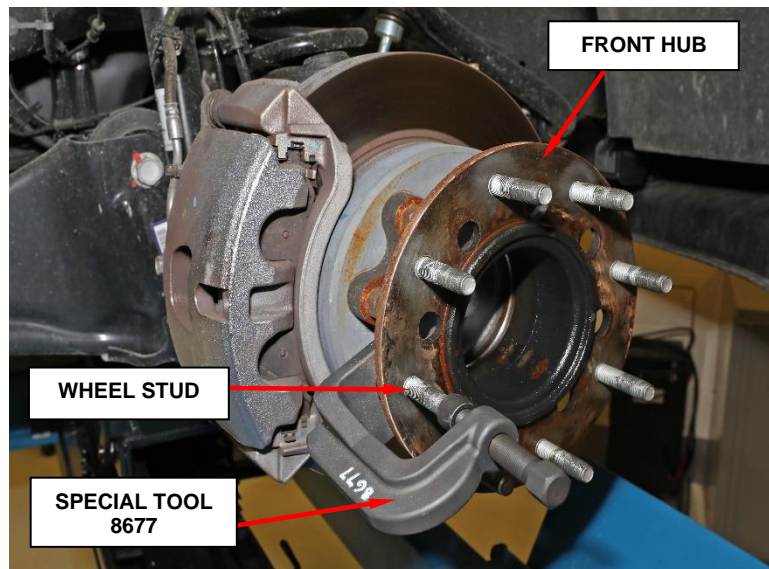
**Figure 5 – Wheel Stud Removal**

6. Tighten the lug nut until the stud is pulled into the hub flange. **Verify that the stud is properly seated into the flange and no gap is present** (Figure 6).

**NOTE: Do not use an air impact tool to install the stud.**

**NOTE: Do Not Exceed 175 N·m (129ft. lbs.) of torque on the lug nut.**

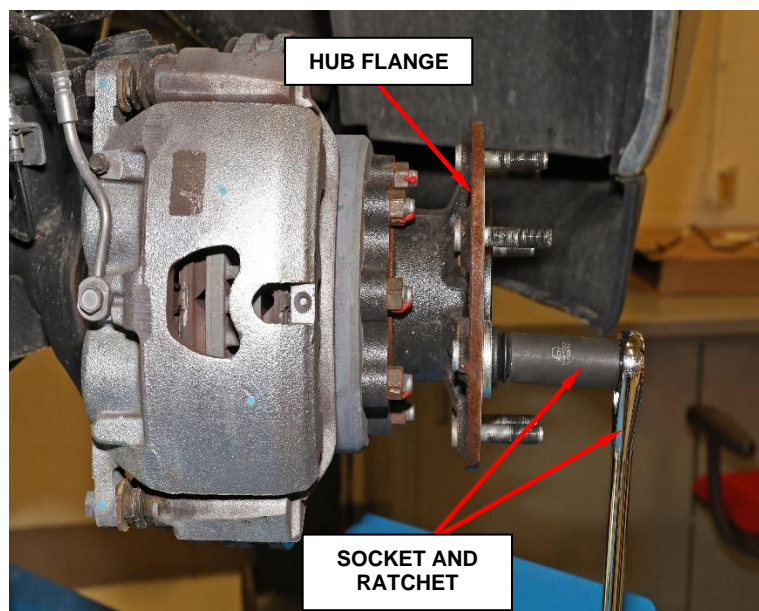
**Figure 6 – Wheel Stud Installation**



**Service Procedure [Continued]**

7. Remove the lug nut and washers.
8. Install the wheel and tire assemblies.
9. Tighten the lug nuts to 175 N·m (129ft. lbs.).

**NOTE: Lug Nut torque specification is a NEW revised specification.**

10. Lower the vehicle.
11. If required, proceed to section **C. Rear Axle Stud Removal and Installation Procedure.**
12. If rear studs do not require replacement, proceed to section **D. Owner's Manual Update.**

**Service Procedure [Continued]**

**C. Rear Axle Stud Removal and Installation Procedure**

1. Raise and support the vehicle.
2. Remove the rear tire and wheel assemblies.
3. Remove the brake caliper adaptor bolts and brake caliper as an assembly and support the caliper (Figure 8).
4. Remove the axle flange bolts (Figure 9).
5. Slide the axle shaft out of the axle tube.

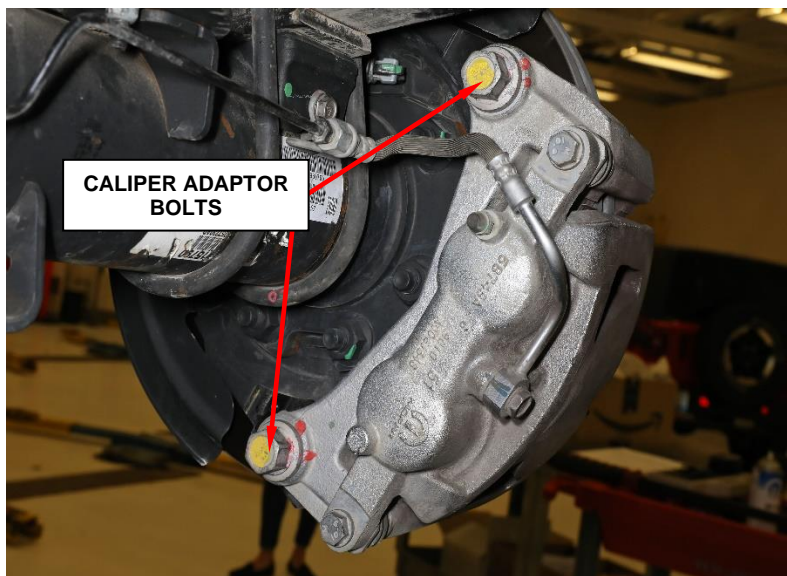

**Figure 8 – Caliper Assembly**

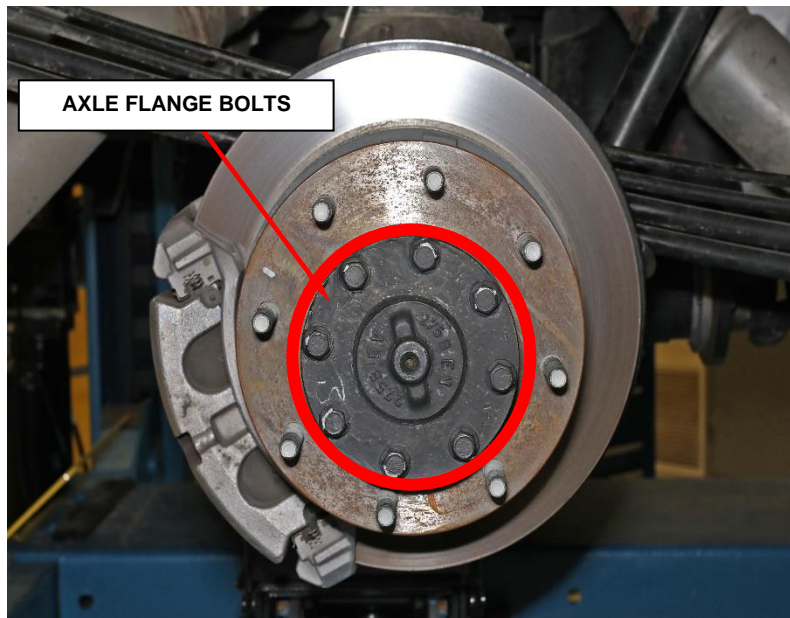

**Figure 9 – Flange Bolts**

**Service Procedure [Continued]**

6. Remove the retaining clip from the hub. **Note the direction it is installed** (Figure 10).

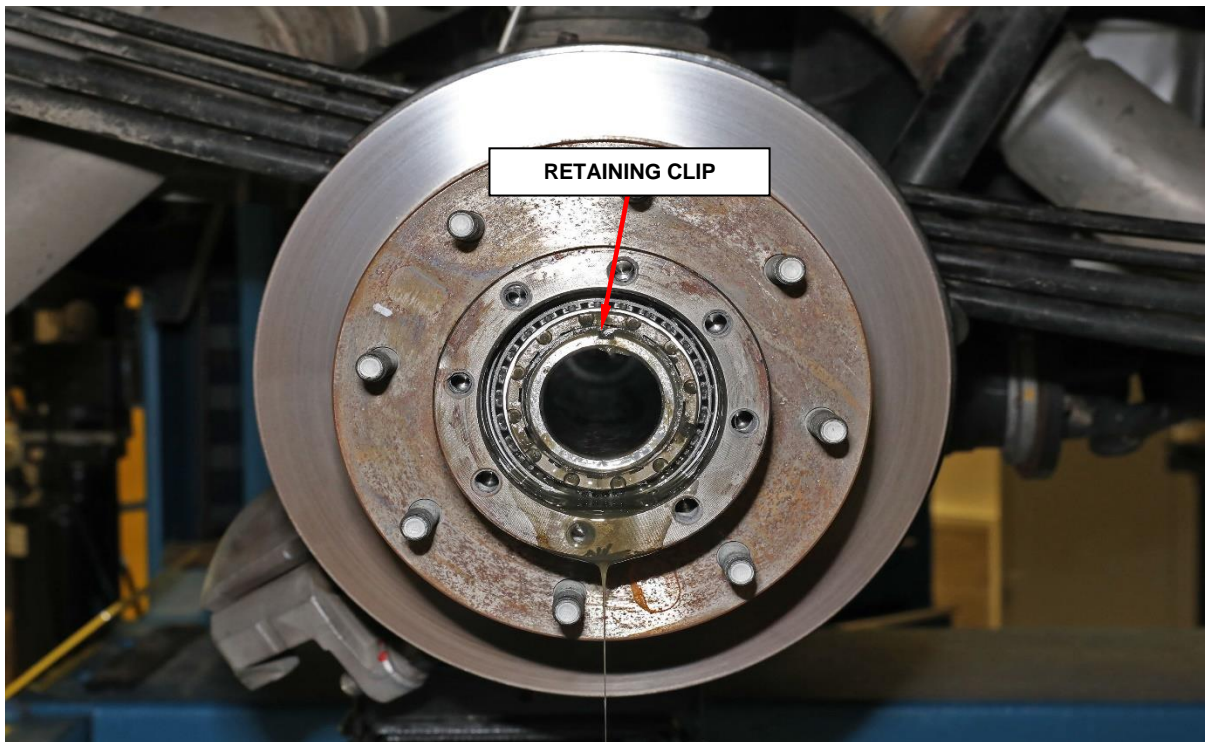
**Figure 10 – Retaining Clip**

7. Remove the hub nut key (Figure 11).

**NOTE:** If hub nut key will not remove freely, loosen or tighten hub nut to free the key.

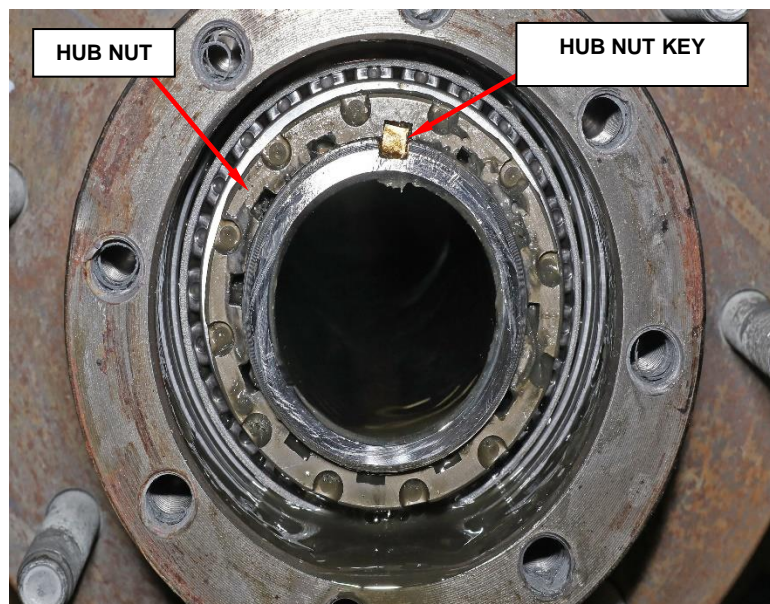
**Figure 11 – Hub Nut Key**

**Service Procedure [Continued]**

8. Using **Socket, Hub Nut 6 Pin 8954A, or Socket, Hub Nut 9 Pin 2029500030, or Socket, Hub Nut 12 Pin 2066600030** remove the hub nut (Figure 12).

9. Remove the hub assembly from the vehicle and set on a clean surface.

10. **If equipped:** Remove the tone ring bolts.

11. **If equipped:** Remove the tone ring.

12. Place a mark on the hub and rotor for re-assembly.

13. Remove the rotor bolts (Figure 13).



**Figure 12 – Hub Nut**

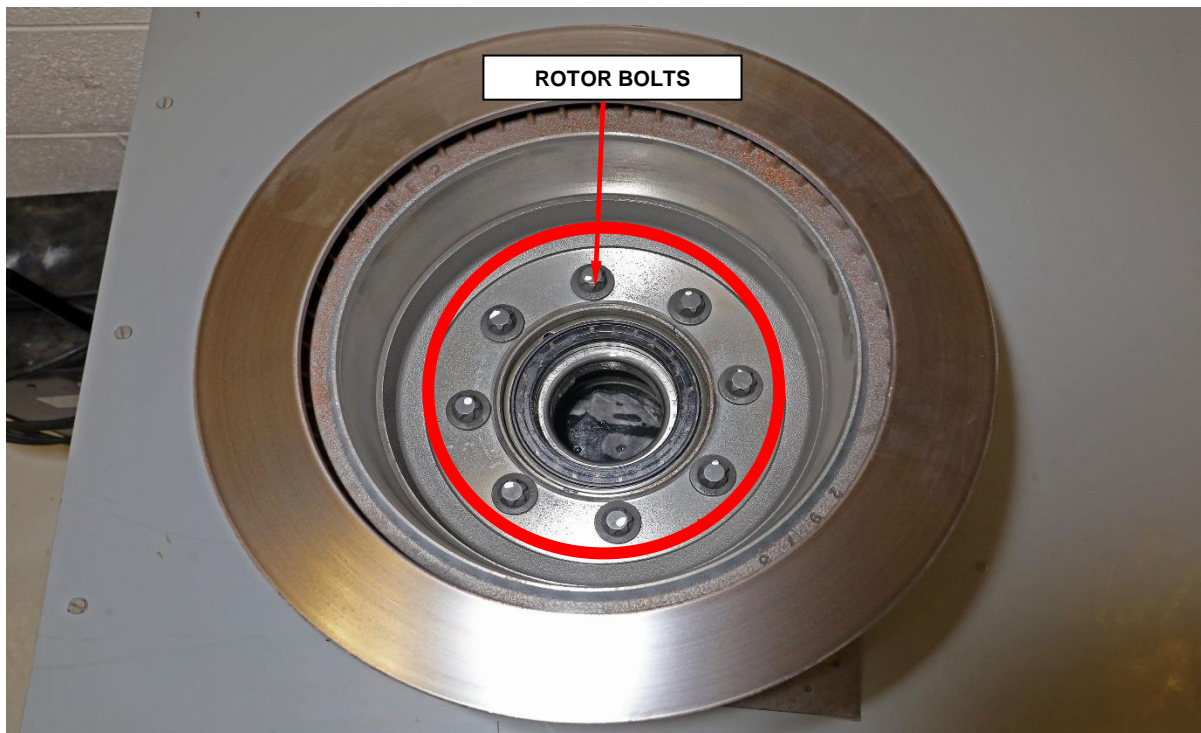

**Figure 13 - Hub Assembly**

**Service Procedure [Continued]**

14. Separate the brake rotor from the wheel hub.
15. Attach special **8677** tool to hub and extract the wheel stud(s) (Figure 14).

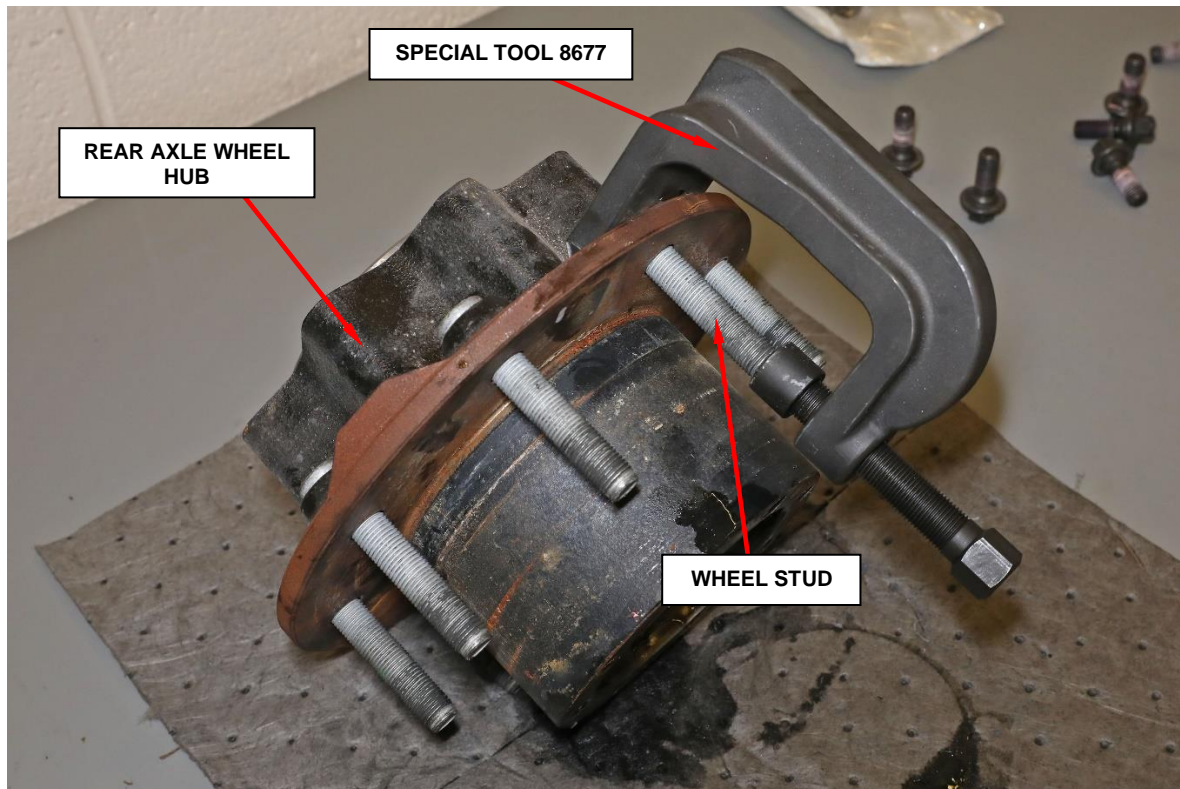

**Figure 14 – Rear Hub Stud Removal**

16. Install the **NEW** stud into the flange, install three proper sized washers onto the **NEW** stud, then install a lug nut.
17. Tighten the lug nut until the stud is pulled into the hub flange. **Verify that the stud is properly seated into the flange and no gap is present.**

**NOTE: Do not use an air impact tool to install the stud.**

**NOTE: Do Not Exceed 175 N·m (129ft. lbs.) of torque on the lug nut.**

18. Remove the lug nut and washers.

**Service Procedure [Continued]**

19. Pry out the hub bearing seal from the back of the hub.
20. Wipe the inner hub clean and repack the inner and out bearings with grease.
21. Install the rear hub bearing.
22. Install **NEW** grease seal with **Installer, Hub Seal 2066700030** and **Handle C-4171** for 12.0” Ring Gear or **Installer, Hub Seal 8693** for 11.5” Ring Gear (Sales Code DRC = 12.0”) (Sales Code DRX=11.5”) (Figure 15).

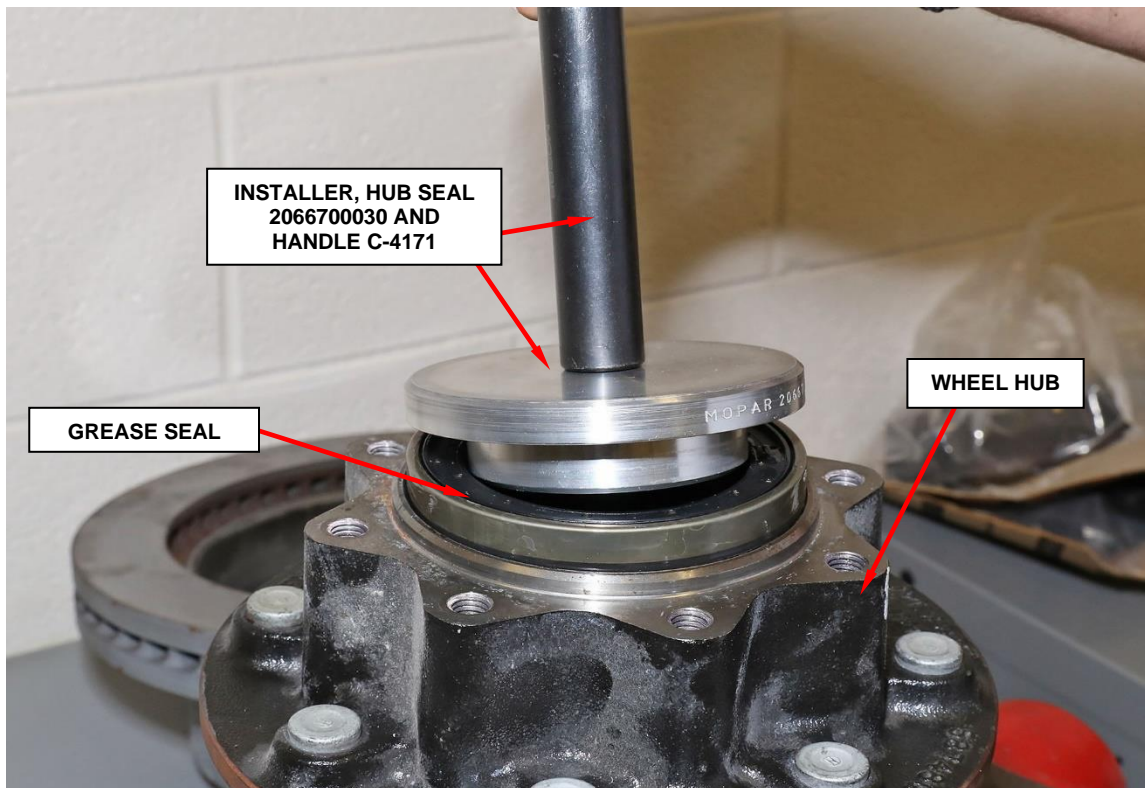
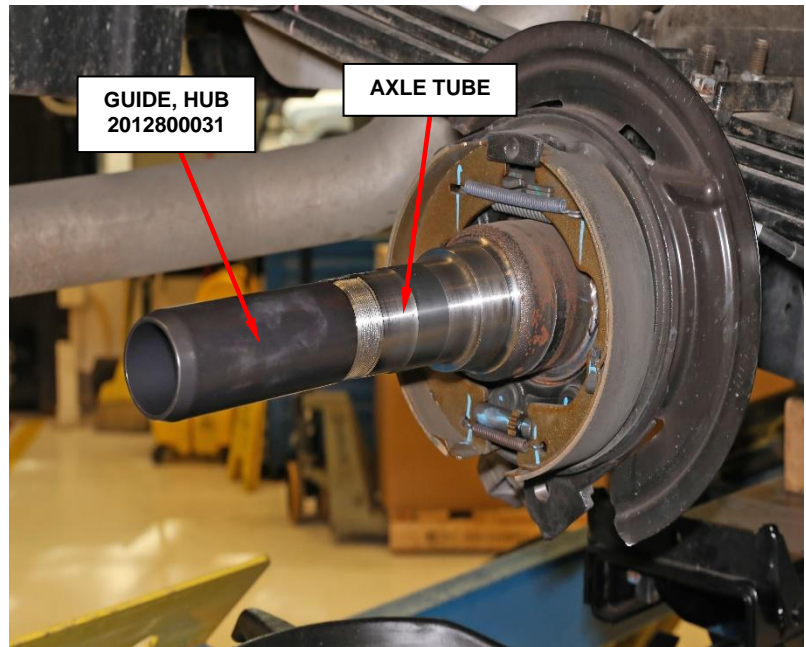

**Figure 15 – Grease Seal Installation**

23. Align the hub and rotor marks previously marked, and position the brake rotor to the wheel hub.
24. Install the **NEW** rotor to hub bolts and tighten to 155N·m (114ft. lbs.).
25. **If equipped:** Position the tone ring to the rotor.
26. **If equipped:** Install the tone ring bolts and tighten to 26 N·m (17ft. lbs.).

**Service Procedure [Continued]**

27. Install the **Guide, Hub 2012800031** hub guide onto the axle tube and slide the hub over the guide and onto the axle tube and install front bearing into the hub (Figure 16).



**Figure – 16 Hub Installation**

28. Install the hub bearing nut **Socket, Hub Nut 2029500030** and tighten the hub bearing nut to 95 N·m (70 ft. lbs.) then reverse the nut 30° and align to the nearest notch (Figure 11).

29. Install the hub nut locking key (Figure 11).

30. Install the retainer ring (Figure 10).

**NOTE: Retaining ring follows threads, with the hook side on the closest thread to the key.**

31. Clean the axle flange and hub.

32. Install a **NEW** Axle Shaft O-ring or gasket (Figure 17).

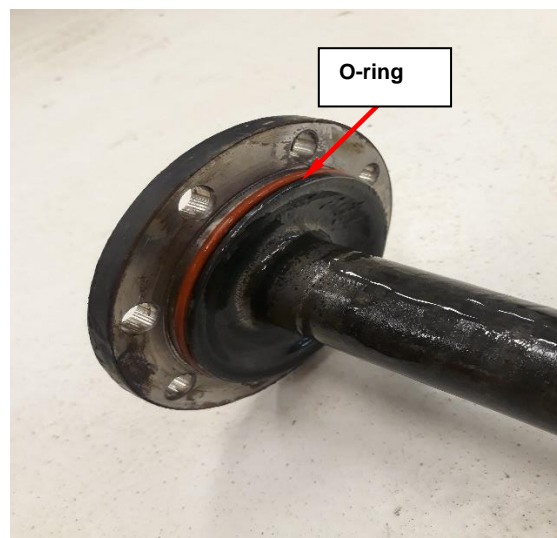

**Figure 17 – Axle Shaft**

**Service Procedure [Continued]**

- 33. Slide axle shaft into the axle tube.
- 34. Install **NEW** axle shaft flange bolts and tighten the bolts to your specific vehicle family, model, year and sales code, and bolt part number, see chart below (Figure 18).

Family	Model Years	Sales Code	Bolt PN	Torque Spec
D2	2012 - Current	DRX	05086770AB	41N·m + 37° (30ft. lbs. + 37°)
	2012-2018	DRS	05086770AB	41N·m + 37° (30ft. lbs. + 37°)
	2019 - Current	DRC	68454743AA 68455377AA	80 N·m + 30° (59ft. lbs. + 30°)
DD	2012- Current	DRX	05086770AB	41N·m + 37° (30ft. lbs. + 37°)
	2019 - Current	DRC	05086770AB	41N·m + 37° (30ft. lbs. + 37°)
DX	2012- Current	DRX	05086770AB	41N·m + 37° (30ft. lbs. + 37°)
DP	2012 -2018	DRT	68036475AA	133 N·m (98 ft. lbs.)
	2019 - Current	DRY	68454743AA 68455377AA	80 N·m + 30° (59ft. lbs. + 30°)

**Figure 18 – Axle Flange Bolt Torque**

- 35. Position the caliper adapter and caliper to the mounting bracket (Figure 8).
- 36. Install the two rear caliper adapter bolts and tighten to:
  - 2012 - 2018 D2, DD** 300N·m (221ft. lbs.) (Figure 8).
  - 2019 - 2021 D2, DD** 353N·m (260ft. lbs.) (Figure 8).
  - 2012 - 2021 DP** 545N·m (402ft. lbs.) (Figure 8).



**Service Procedure [Continued]**

37. Remove the rear differential oil fill plug (Figure 19).

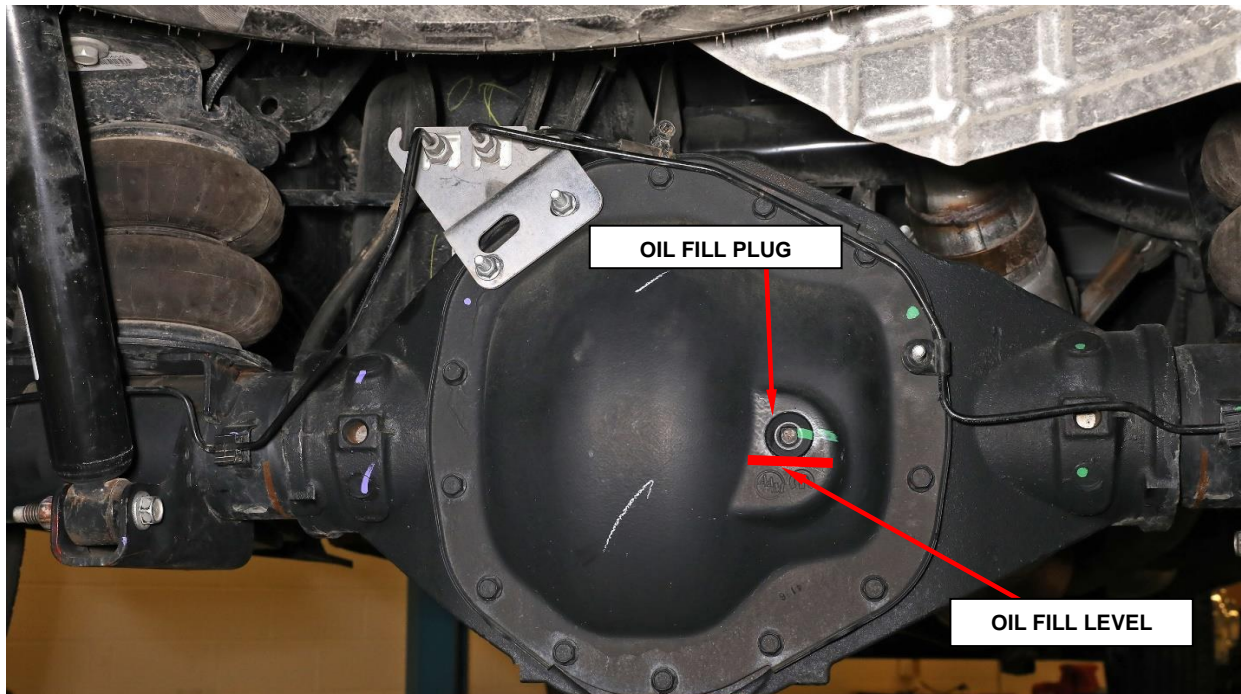

**Figure 19 – Oil Fill Plug**

38. Verify the oil level is within 0.25” of the fill plug, add as needed (Figure 19).
39. Install the fill plug and tighten to 32N·m (24ft. lbs.)
40. Install the tire and wheel assemblies.
41. Tighten the lug nuts to 175 N·m (129ft. lbs.).  
**NOTE: Lug Nut torque specification is a NEW revised specification.**
42. Lower the vehicle and proceed to Section **D. Owner’s Manual Update.**

**Service Procedure [Continued]**

**D. Owner's Manual Update**

1. Obtain the owner's/user's manual from the vehicle's glove box, and attach the adhesive label over the existing wheel lug nut torque specifications section. Staple the addendum card onto the same page of the manual and reinstall owner's/user's manual into the glove box (Figure 20).

**NOTE: If the owner's manual is not available, provide the addendum/label to the customer and advise them to attach the label and the addendum card in the lug nuts torque section of the manual.**

**INFORMATION LOCATION MAY VARY FROM VEHICLE FAMILY AND MODEL YEAR.** Please ensure the label is placed over the existing incorrect torque information. The following two examples are variances in location of the lug nut torque specification:

**Service Procedure [Continued]**

ADHERE THE NEW INFORMATION LABEL TO THIS SECTION  
 PAY SPECIAL ATTENTION TO COVERING THE FLANGED LUG NUT TORQUE 140 FT-LB / 190 N-m.

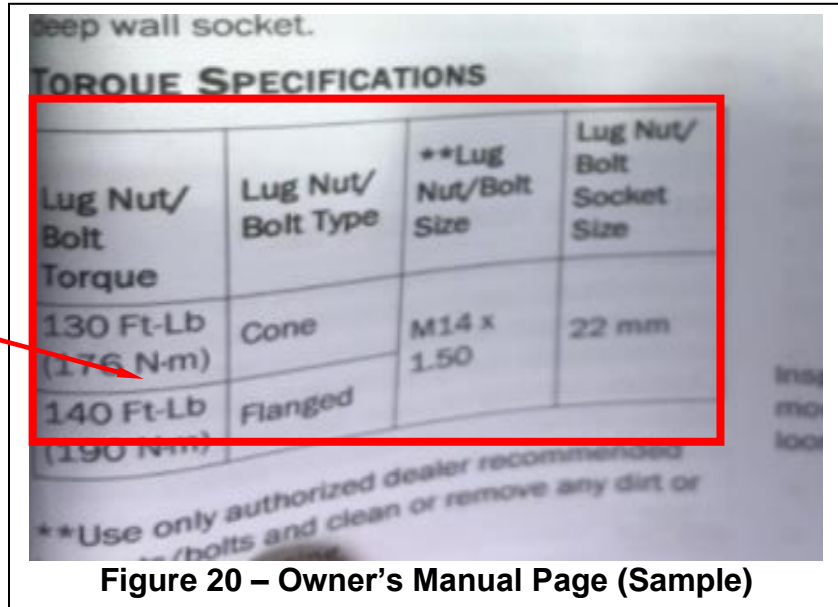

Figure 20 – Owner’s Manual Page (Sample)

ADHERE THE NEW INFORMATION LABEL TO THIS SECTION  
 PAY SPECIAL ATTENTION TO COVERING THE FLANGED LUG NUT TORQUE 140 FT-LB / 190 N-m.

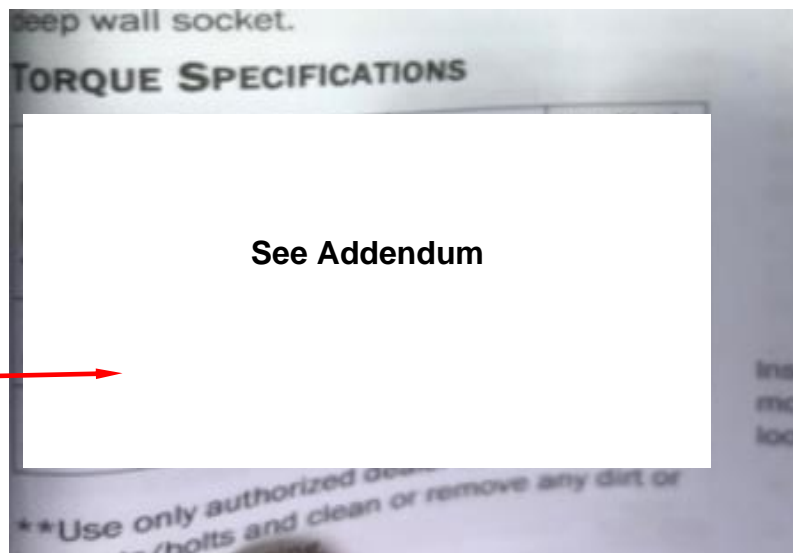

Figure 21 – Owner’s Manual Page

**THIS ADDENDUM UPDATES INFORMATION ON “TORQUE SPECIFICATIONS” IN THE “TECHNICAL SPECIFICATIONS” SECTION OF YOUR OWNER’S MANUAL**

Lug Nut/Bolt Torque	Lug Nut/Bolt Type	Lug Nut/Bolt Size	Lug Nut/Bolt Socket Size
130 Ft-Lb (176 Nm)	Cone	M14 x 1.50	22 mm
129 Ft-Lb (175 Nm)	Flanged		

**NOTE:**  
 Dual wheels are flat mounted, center piloted. The lug nuts are a two-piece assembly. When the tires are being rotated or replaced, clean these lug nuts at the interface between the lug nut/bolt and the washer. **Do not oil wheel studs.**

Figure 22 – New Addendum Card

**Service Procedure [Continued]**

### WHAT TO DO IN EMERGENCIES

8. Lower the jack to its fully closed position. If the bottle jack will not lower by turning the dial (thumbwheel) by hand, it may be necessary to use the jack drive tube in order to lower the jack. Stow the replaced tire, jack, and tools as previously described.

9. Adjust the tire pressure when possible.

**NOTE:** Do not oil wheel studs. For chrome wheels, do not substitute with chrome plated wheel nuts.

**Hub Caps/Wheel Covers**

- The hub caps must be removed before raising the vehicle off the ground.
- For 2500/3500 single rear-wheel (SRW) models, use the blade on the end of the lug wrench to pry the hub cap off. Insert the blade end into the pry-off notch and carefully pop off the hub cap with a back-and-forth motion.
- On 3500 models with dual rear wheels (DRW), you must first remove the hub caps. The jack handle driver has a hook at one end that will fit in the pry off notch of the rear hub caps. Position the hook and pull out on the ratchet firmly. The hub cap should pop off. The wheel skins can now be removed. For the front hub cap on 3500 models use the blade on the end of the lug wrench to pry the caps off. The wheel skin can now be removed.
- You must use the flat end of the lug wrench to pry off the wheel skins. Insert the flat tip completely and using a back-and-forth motion, loosen the wheel skin. Repeat this procedure around the tire until the skin pops off.
- Replace the wheel skins first using a rubber mallet. When replacing the hub caps, tilt the cap retainer over the lug nut bolt circle and strike the high side down with a rubber mallet. Be sure that the hub caps and wheel skins are firmly seated around the wheel.

**Wheel Nuts**

- All wheel nuts should be tightened occasionally to eliminate the possibility of wheel studs being sheared or the bolt holes in the wheels becoming elongated. This is especially important during the first few hundred miles/kilometers of operation to allow the wheel nuts to become properly set. All wheel nuts should first be firmly seated against the wheel. The wheel nuts should then be tightened to recommended torque. Tighten the wheel nuts to final torque in increments. Progress around the bolt circle, tightening the wheel nut opposite to the wheel nut just previously tightened until final torque is achieved. Recommended torques are shown in the following chart.

Disc Wheels	Type Nut	Stud Size	Hex Size	Torque Ft Lbs	Torque Newton Meters
	Cone	M14 x 1.5	22 mm	120-150	160-200
	Flanged	M14 x 1.5	22 mm	130-160	190-220

**ADHERE THE NEW INFORMATION LABEL TO THIS SECTION  
PAY SPECIAL ATTENTION TO COVERING THE FLANGED LUG NUT TORQUE 140 FT-LB / 190 N-m.**

**Figure 23 – User’s Guide**

**Service Procedure [Continued]**

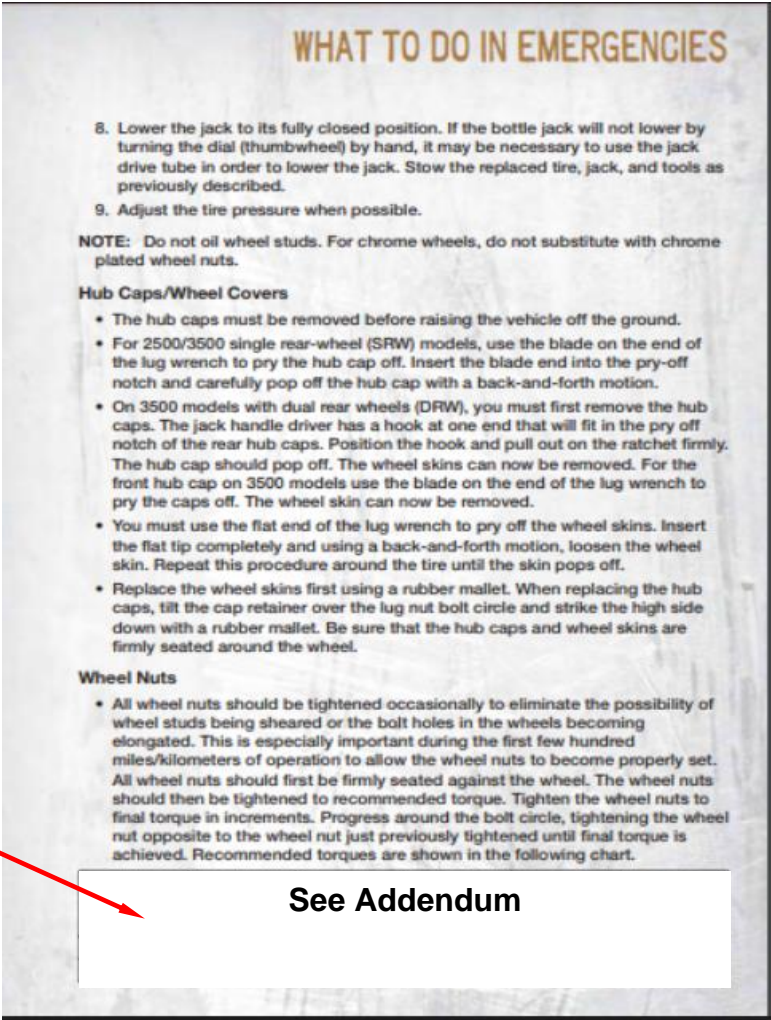

ADHERE THE NEW INFORMATION LABEL TO THIS SECTION  
 PAY SPECIAL ATTENTION TO COVERING THE FLANGED LUG NUT TORQUE 140 FT-LB / 190 N-m.

Figure 24 – User’s Guide

**THIS ADDENDUM UPDATES INFORMATION ON “TORQUE SPECIFICATIONS” IN THE “TECHNICAL SPECIFICATIONS” SECTION OF YOUR OWNER’S MANUAL**

Lug Nut/Bolt Torque	Lug Nut/Bolt Type	Lug Nut/Bolt Size	Lug Nut/Bolt Socket Size
130 Ft-Lb (176 Nm)	Cone	M14 x 1.50	22 mm
129 Ft-Lb (175 Nm)	Flanged		

**NOTE:**  
 Dual wheels are flat mounted, center piloted. The lug nuts are a two-piece assembly. When the tires are being rotated or replaced, clean these lug nuts at the interface between the lug nut/bolt and the washer. **Do not oil wheel studs.**

Figure 25 – New Addendum Card

**Completion Reporting and Reimbursement**

Claims for vehicles that have been serviced must be submitted on the DealerCONNECT Claim Entry Screen located on the Service tab. Claims paid will be used by FCA to record recall service completions and provide dealer payments.

Use the following labor operation numbers and time allowances:

The main LOP’s are based on ONE wheel stud being replaced per axle. For additional wheel studs, claim the related LOP as appropriate.

	<b>Labor Operation Number</b>	<b>Time Allowance</b>
Inspect Wheel Studs If pass, insert addendum card/label and close recall.	22-Y2-61-81	0.6 hours
Inspect and Replace Wheel Studs - Front (One Side or Both Sides)	22-Y2-61-82	0.7 hours
Inspect and Replace Wheel Studs - Rear (One Side)	22-Y2-61-83	1.6 hours
Inspect and Replace Rear Wheel Studs - Rear (Both Sides)	22-Y2-61-84	2.5 hours
Inspect and Replace Wheel Studs - Front (One Side or Both Sides) and Rear (One Side)	22-Y2-61-85	1.6 hours
Inspect and Replace Wheel Studs - Front (One or Both Sides) and Rear (Both Sides)	22-Y2-61-86	2.5 hours

**Related Operations**

Replacement of up to 2 additional studs (Can be claimed multiple times as required)	22-Y2-61-50	0.1 hours
10 Lug Equipped	22-Y2-61-60	0.1 hours
Antilock Brakes Equipped (Tone Wheel)	22-Y2-61-61	0.2 hours

**Floor Plan Reimbursement**

Floor Plan Reimbursement 95-95-95-97 Calculate See Below

Floor Plan Reimbursement represents the vehicle’s average daily allowance (see table below) multiplied by the number of days the vehicle was in dealer inventory and not available for sale. This reimbursement is limited to the number of days from the date of the stop sale to the date that the remedy was made available. Note: If the vehicle was received by your dealership (KZX date) AFTER the stop sale date, you will use the KZX date instead of the stop sale date. For this Recall, the stop sale was initiated on **06/08/2021**.

The remedy was made available for 2019 – 2021 models on **11/23/2021**, therefore, the number of days cannot exceed **169** days.

The remedy was made available for 2015 – 2018 models on **12/21/2021**, therefore, the number of days cannot exceed **196** days.

Vehicle	Average Daily Allowance
2015 – 2021 D2	██████
2015 – 2021 DD	██████
2015 – 2021 DP	██████

**NOTE: See the Warranty Administration Manual, Recall Claim Processing Section, for complete recall claim processing instructions.**

**Dealer Notification**

To view this notification on DealerCONNECT, select “Global Recall System” on the Service tab, then click on the description of this notification.

**Owner Notification and Service Scheduling**

All involved vehicle owners known to FCA are being notified of the service requirement by first class mail. They are requested to schedule appointments for this service with their dealers. A generic copy of the owner letter is attached.

**Vehicle Lists, Global Recall System, VIP and Dealer Follow Up**

All involved vehicles have been entered into the DealerCONNECT Global Recall System (GRS) and Vehicle Information Plus (VIP) for dealer inquiry as needed.

GRS provides involved dealers with an updated VIN list of their incomplete vehicles. The owner's name, address and phone number are listed if known. Completed vehicles are removed from GRS within several days of repair claim submission.

To use this system, click on the “**Service**” tab and then click on “**Global Recall System.**” Your dealer's VIN list for each recall displayed can be sorted by: those vehicles that were unsold at recall launch, those with a phone number, city, zip code, or VIN sequence.

**Dealers must perform this repair on all unsold vehicles before retail delivery.** Dealers should also use the VIN list to follow up with all owners to schedule appointments for this repair.

*Recall VIN lists may contain confidential, restricted owner name and address information that was obtained from the Department of Motor Vehicles of various states. Use of this information is permitted for this recall only and is strictly prohibited from all other use.*

**Additional Information**

If you have any questions or need assistance in completing this action, please contact your Service and Parts District Manager.

Customer Services / Field Operations  
FCA US LLC



This notice applies to your vehicle,

[Model Year and Model]

VIN XXXXXXXXXXXXXXXXXXXX

Y26/NHTSA 21V-398

LOGO

VEHICLE PICTURE

#### YOUR SCHEDULING OPTIONS

**1. RECOMMENDED OPTION**

Call your authorized Chrysler / Dodge / Jeep® / RAM BusinessLink / Dealership.

**2. Call the FCA Recall Assistance Center at 1-800-853-1403. An agent can confirm part availability and help schedule an appointment**

**3. Visit recalls.mopar.com, scan the QR code below, or download the Mopar Owner's Companion App.**

QR Code

Get access to recall notifications, locate your nearest dealer, and more through this website or Mopar Owner's Companion App. You will be asked to provide your Vehicle Identification Number (VIN) to protect and verify your identity. The last eight characters of your VIN are provided above.

#### DEALERSHIP INSTRUCTIONS

Please reference Safety Recall Y26.

# IMPORTANT SAFETY RECALL

## Wheel Studs

Dear [Name],

This notice is sent to you in accordance with the National Traffic and Motor Vehicle Safety Act.

FCA US has decided that a defect, which relates to motor vehicle safety, exists in certain [2012 – 2020 Model Year (D2) Ram 3500 Pickup, (DD) Ram 3500 Cab Chassis, and (DP) Ram 4500/5500 Cab Chassis] trucks.

It is extremely important to take steps now to repair your vehicle to ensure the safety of you and your passengers.

#### WHY DOES MY VEHICLE NEED REPAIRS?

The flanged wheel lug nuts on your vehicle <sup>[1]</sup> may have been over-torqued during service to an incorrect torque specification in the Service & Owner's manual, which can yield a wheel stud. **A yielded wheel stud may eventually break, which could lead to a wheel separating from the vehicle during operation. A wheel separating from the vehicle could cause a vehicle crash without prior warning and/or the wheel/tire could pose a risk to other vehicles or pedestrians.**

#### HOW DO I RESOLVE THIS IMPORTANT SAFETY ISSUE?

FCA US will repair your vehicle <sup>[2]</sup> free of charge (parts and labor). To do this, your dealer will inspect all the wheel studs and update the torque specification in the owner's information. If any wheel stud is found that has potentially yielded, it will be replaced and the lug nuts will be tightened to the updated torque specification. The estimated repair time is about 2 hours. In addition, your dealer will require your vehicle for proper check-in, preparation, and check-out during your visit, which may require more time. Your time is important to us, so we recommend that you schedule a service appointment to minimize your inconvenience. Please bring this letter with you to your dealership.

Please note that your vehicle might have been sold under a second stage manufacturer brand name and is different than the model indicated above. However, your vehicle has to be serviced at an authorized **Chrysler / Dodge / Jeep® / RAM / BusinessLink** Dealership for all FCA recalls.

**TO SCHEDULE YOUR FREE REPAIR,  
CALL YOUR CHRYSLER, DODGE, JEEP, RAM OR BUSINESSLINK DEALER  
TODAY**

#### WHAT IF I ALREADY PAID TO HAVE THIS REPAIR COMPLETED?

If you have already experienced this specific condition and have paid to have it repaired, you may visit [www.fcarecallreimbursement.com](http://www.fcarecallreimbursement.com) to submit your reimbursement request online. <sup>[3]</sup> Once we receive and verify the required documents, reimbursement will be sent to you within 60 days. If you have had previous repairs performed and/or already received reimbursement, you may still need to have the recall repair performed.

We apologize for any inconvenience, but are sincerely concerned about your safety. Thank you for your attention to this important matter.

Customer Assistance/Field Operations  
FCA US LLC



**Mr. Mrs. Customer**  
**1234 Main Street**  
**Hometown, MI 48371**

[1] If you no longer own this vehicle, please help us update our records. Call the FCA Recall Assistance Center at 1-800-853-1403 to update your information.

[2] If your dealer fails or is unable to remedy this defect without charge and within a reasonable time, you may submit a written complaint to the Administrator, National Highway Traffic Safety Administration, 1200 New Jersey Ave., S.E., Washington, DC 20590, or you can call the toll-free Vehicle Safety Hotline at 1-888-327-4236 (TTY 1-800-424-9153), or go to [safercar.gov](http://safercar.gov).

[3] You can also mail in your original receipts and proof of payment to the following address for reimbursement consideration: FCA Customer Assistance, P.O. Box 21-8004, Auburn Hills, MI 48321-8007, Attention: Recall Reimbursement.

Note to lessors receiving this recall notice: Federal regulation requires that you forward this recall notice to the lessee within 10 days.