



April 2021

Dealer Service Instructions for:

Safety Recall Y15 / NHTSA 21V-221

Side Curtain Air Bag

Remedy Available

2021 (GU) Alfa Romeo Stelvio

NOTE: Some vehicles above may have been identified as not involved in this recall and therefore have been excluded from this recall.

IMPORTANT: Some of the involved vehicles may be in dealer new vehicle inventory. Federal law requires you to complete this recall service on these vehicles before retail delivery. Dealers should also consider this requirement to apply to used vehicle inventory and should perform this recall on vehicles in for service. Involved vehicles can be determined by using the VIP inquiry process.

Subject

The Side Air Bag Inflatable Curtain (SABIC) assembly on about 1,200 of the above vehicles may have been built with an improperly crimped clamp. A damaged SABIC clamp may allow the cushion and inflator to separate during a SABIC deployment. An incomplete deployment or non-deployment of the side curtain air bag increases the risk of injury in the event of a crash.

Repair

Replace both side curtain air bags.

Service Procedure

A. Side Curtain Air Bag Removal

1. Move both front seats to the forward end of travel position, fully recline both front seat backs, lower the rear seat backrests down, and ensure the lift gate is open before disconnecting the battery.
2. Disconnect and isolate the negative battery cable. Wait two minutes for the system capacitor to discharge before further service.

WARNING: To avoid serious or fatal injury on vehicles equipped with air bags, disable the Supplemental Restraint System (SRS) before attempting any side curtain air bag service. Disconnect the Intelligent Battery Sensor (IBS)/negative battery cable assembly from the negative battery post, then wait two minutes for the system capacitor to discharge before performing further diagnosis or service. This is the only sure way to disable the SRS. Failure to take the proper precautions could result in accidental air bag deployment.

WARNING: To avoid serious or fatal injury, use extreme care to prevent any foreign material from entering the side curtain air bag, or becoming entrapped between the side curtain air bag cushion and the headliner. Failure to observe this warning could result in occupant injuries upon air bag deployment.

NOTE: The left (or right) side is illustrated for some operations. Perform the same operations on the other side as well.

3. Raise the headrest (1) to end of travel position (Figure 1).
4. Press the retainers (2a) and (2b) together and extract the headrest (1) (Figure 1).

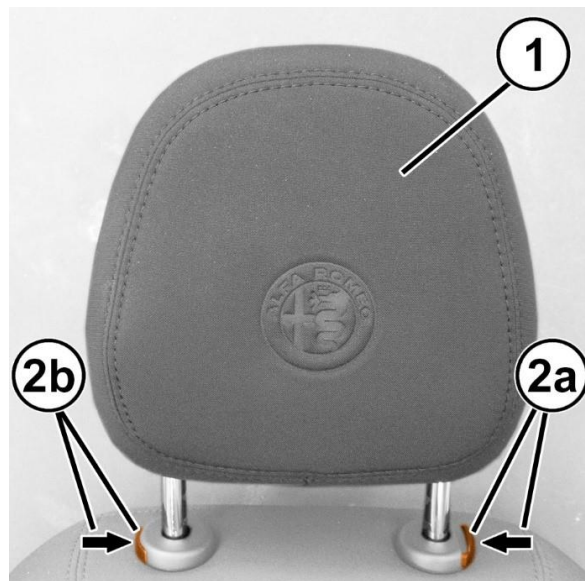

Figure 1 – Headrest

Service Procedure [Continued]

5. Remove the seat belt bezel (1a) by releasing its retainers (1b) then guide the seat belt (1c) out through the slot (1d) (Figure 2).



6. Release the retainers (2b) of the rear seat bolster (2a) (Figure 2).

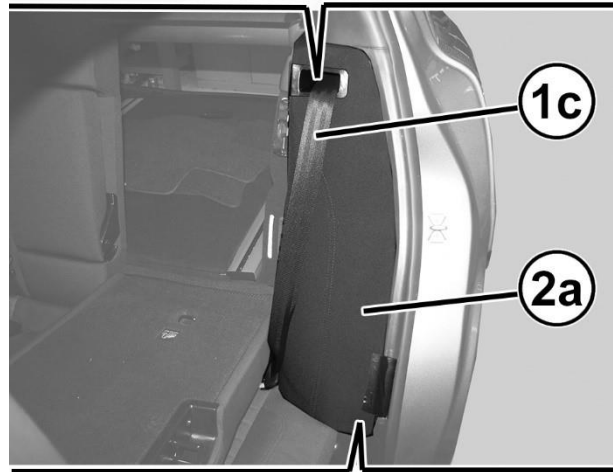

7. Remove the rear seat bolster (2a) by guiding the seat belt (1c) out through the slot (3a) (Figure 2).

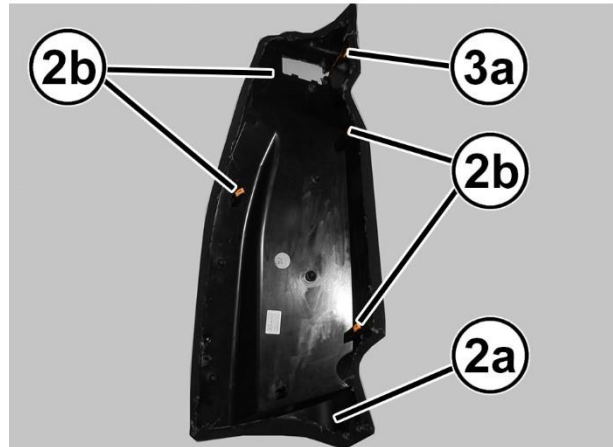

Figure 2 – Rear Seat Bolster

Service Procedure [Continued]

8. If equipped, release the cargo cover (1a) and roll it back (Figure 3).

9. If equipped, retract the movable ends (2a) then remove the cargo cover (1a) from the cargo area attachment locations (Figure 3).

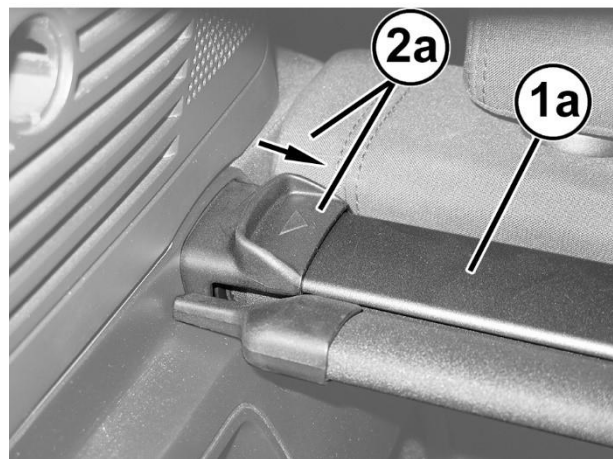
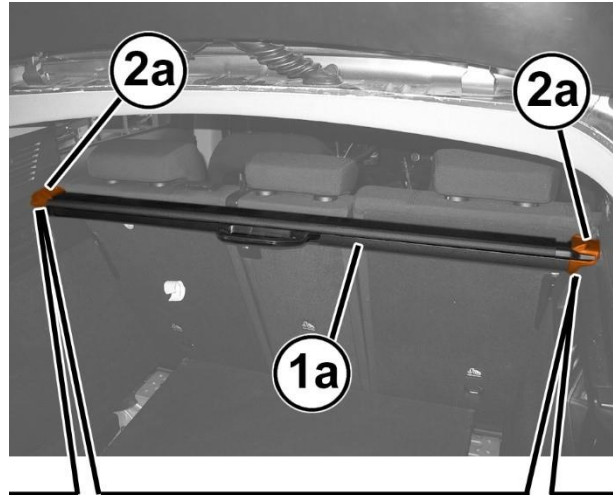

Figure 3 – Cargo Cover

10. Extract the roof lamp (1a), releasing the flexible retainer (1b) and rigid retainer (1c) (Figure 4).

11. Disconnect the electrical connection (2) and retrieve the roof lamp (3) (Figure 4).

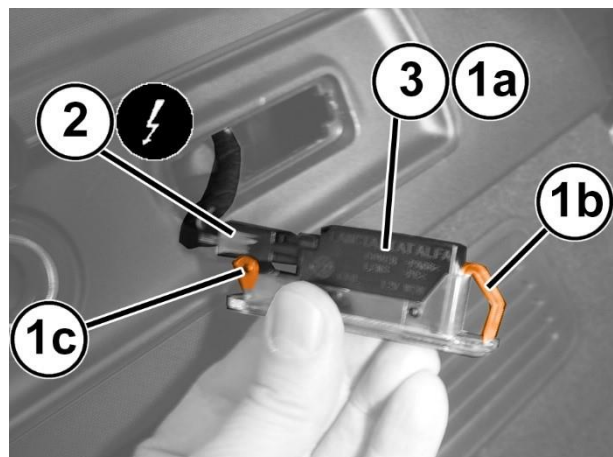
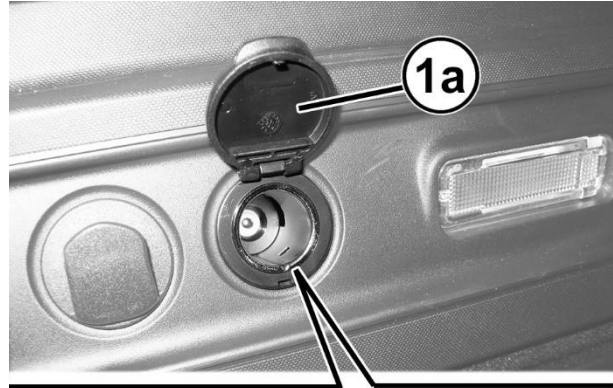

Figure 4 – Roof Lamp

Service Procedure [Continued]

12. Open the cover (1a) of the power socket (Figure 5).



13. Engage the power outlet remover tool 9857 (2a) in the recesses (2b) of the power socket and carefully extract the power socket (2c). During the removal of the power socket (2c), its ridges (2d) must slide in the housing (2e) (Figure 5).

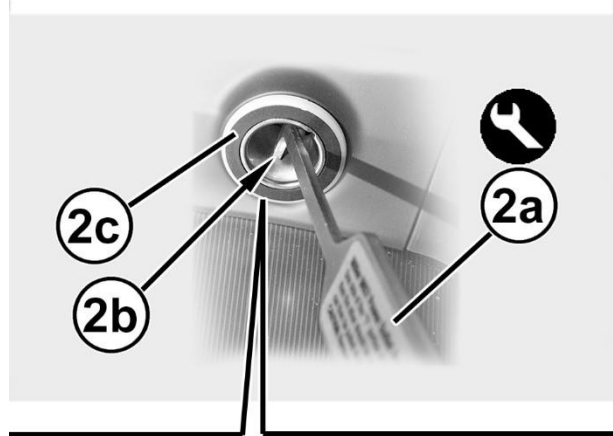

14. Disconnect the electrical connection (3a) and remove the power socket (2c) without removing the ring (4a) (Figure 5).

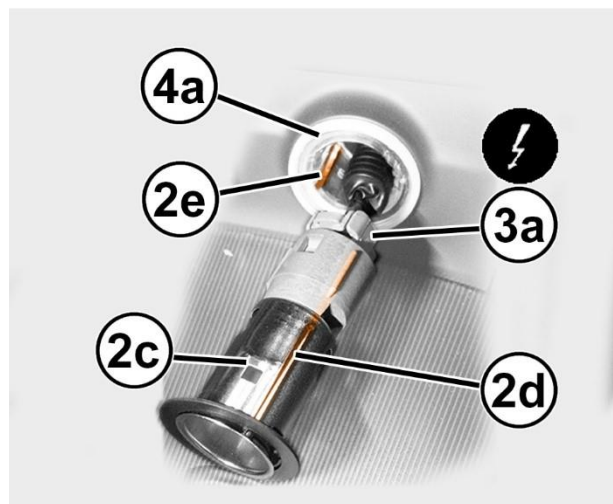

Figure 5 – Power Socket

Service Procedure [Continued]

15. Release the tailgate frame weather strip (1a) in the C-pillar trim area (1b) (Figure 6).

16. Release the cover and remove the screw (2a) (Figure 6).

17. Remove the C-pillar trim panel (1b) releasing the inner retainers (3a) using a trim stick C-4755 (1878077000) or equivalent (Figure 6).

18. Unclip the cable ferrule (4a) and remove the cable end (4b) of the rear seat backrest release handle cable (4c) (Figure 6).

19. Remove the C-pillar trim panel (1b) (Figure 6).

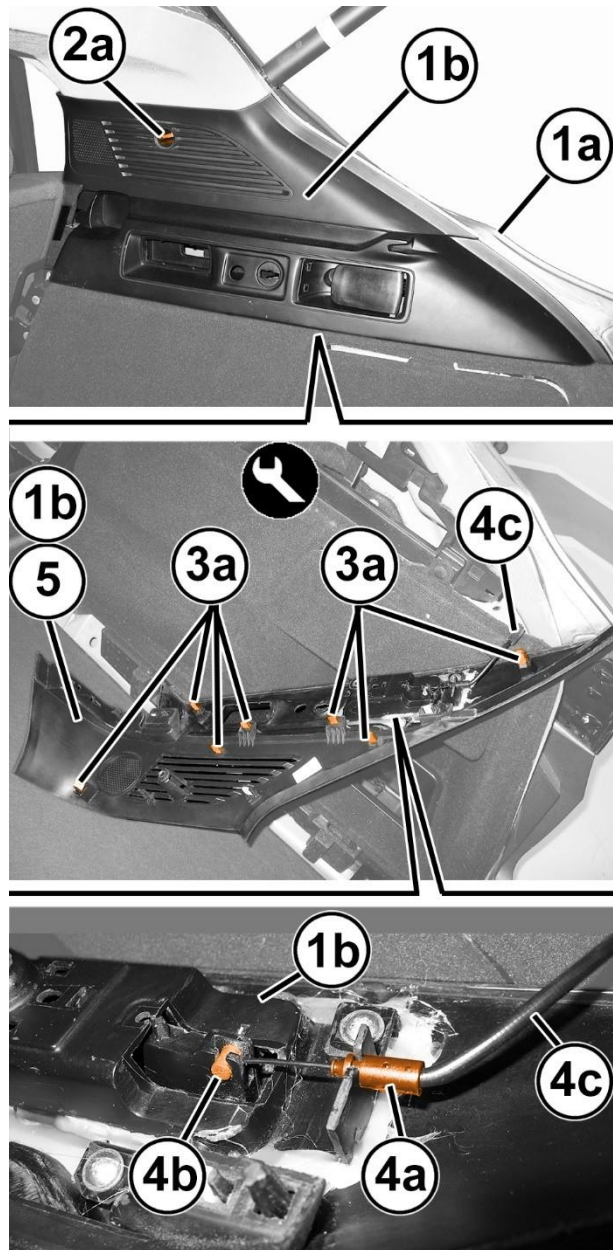
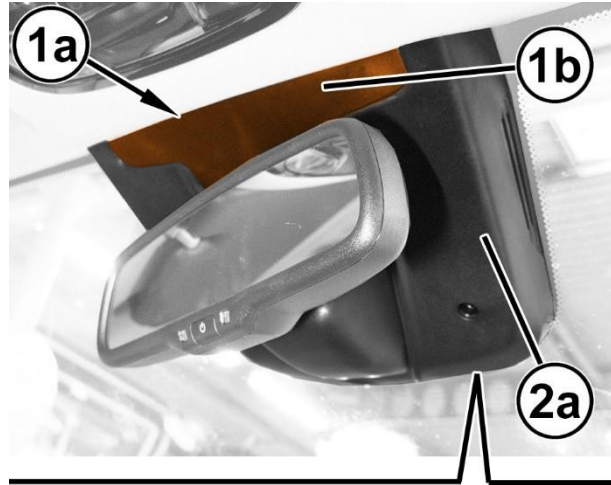

Figure 6 – C-Pillar Trim Panel

Service Procedure [Continued]

20. With a trim stick, lift up the upper area (1a) and remove the mirror trim (1b) releasing its retainers (Figure 7).



21. Move the outer mirror trim (2a) aside, releasing its retainers (2b) (Figure 7).

22. Release the sensor (3a) from the four retainers (3b) (Figure 7).

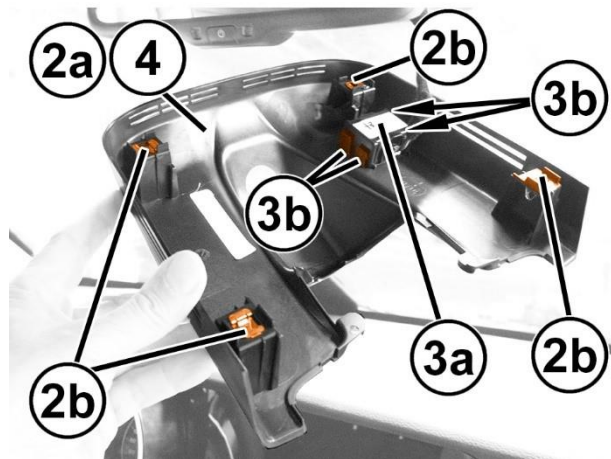

23. Remove the outer mirror trim (2a) (Figure 7).

Figure 7 – Mirror Trim

Service Procedure [Continued]

24. Lower the sun visor (1a) and release it from the retainer (1b) (Figure 8).

25. Release and lower the cover (2a) (Figure 8).

26. Remove the screw (3a) (Figure 8).

27. Release and lower the sun visor (1a) (Figure 9).

28. Disconnect the electrical connection (2a) of the sun visor after removing its foam covering (Figure 9).

29. Remove the sun visor (3) (Figure 9).

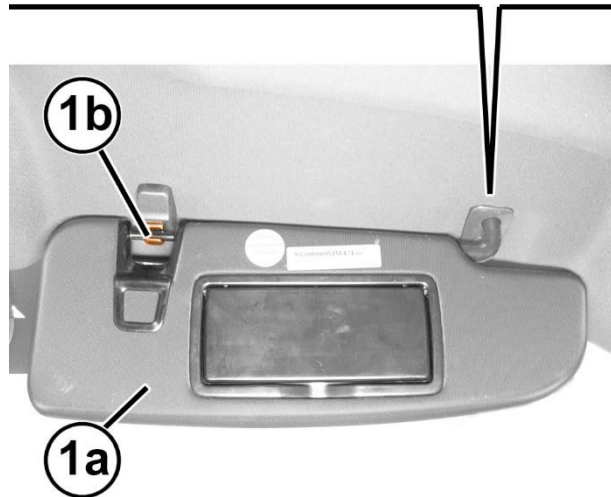
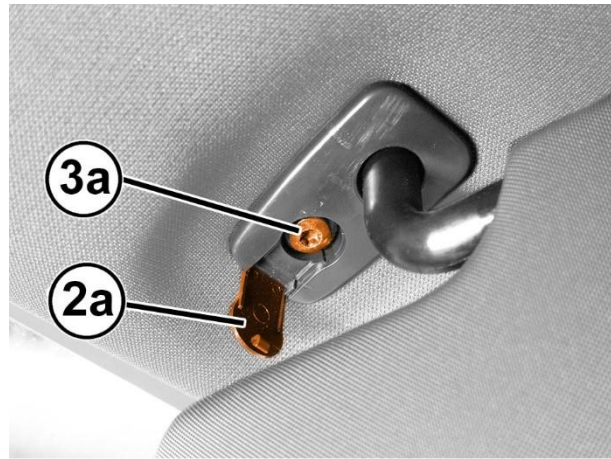

Figure 8 – Sun Visor

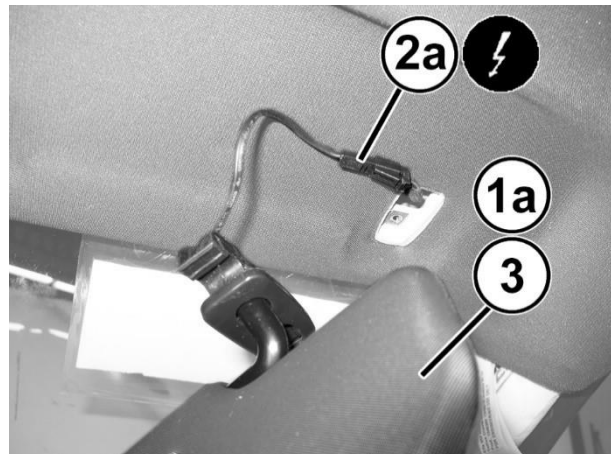

Figure 9 – Sun Visor Electrical

Service Procedure [Continued]

30. Release the cover (1a), remove the screw (1b) and then remove the retainer (1c) (Figure 10).

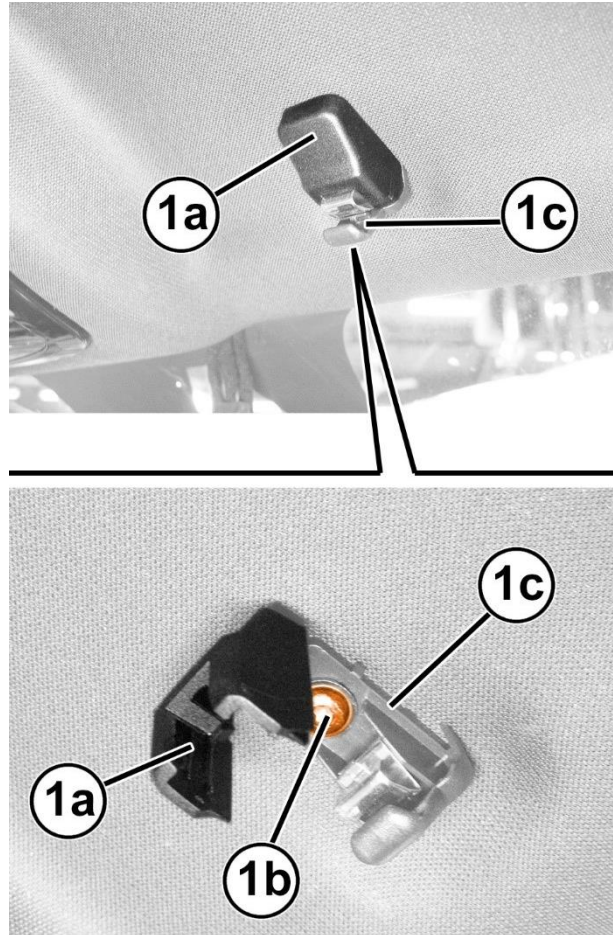

Figure 10 – Sun Visor Retainer

Service Procedure [Continued]

- 31. Lower the roof lamp (1a) releasing the inner retainers (1b) (Figure 11).

CAUTION: Do not force the edges (1c) to avoid damaging the internal components of the roof lamp (Figure 11).

- 32. Remove the roof lamp (1a) (Figure 11).

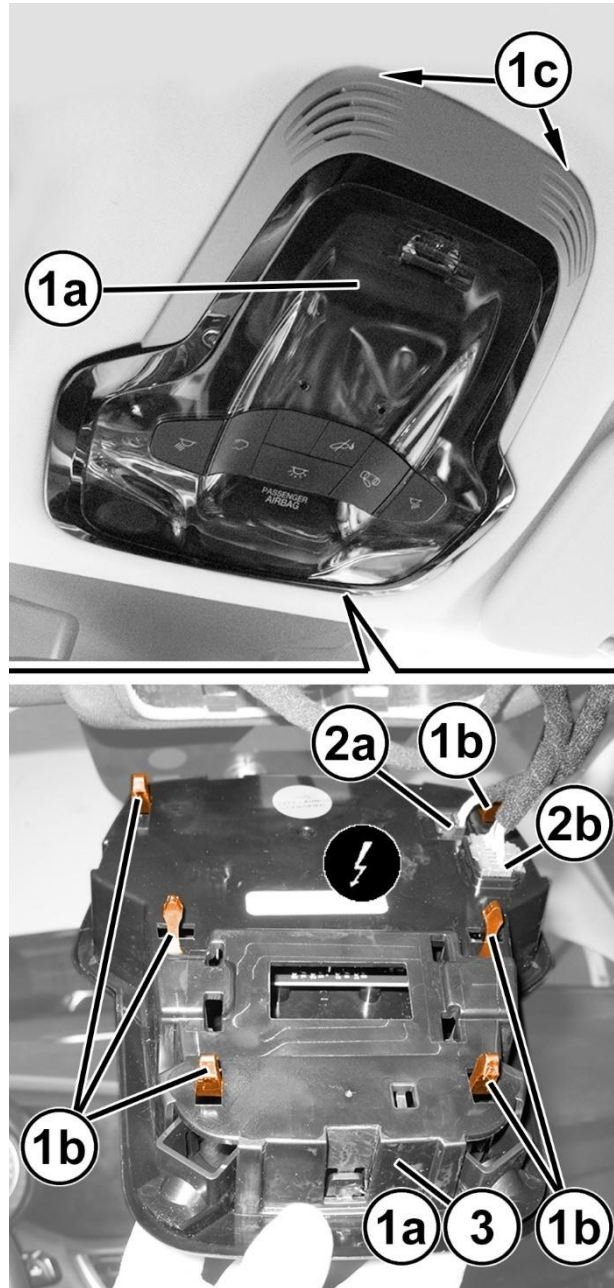
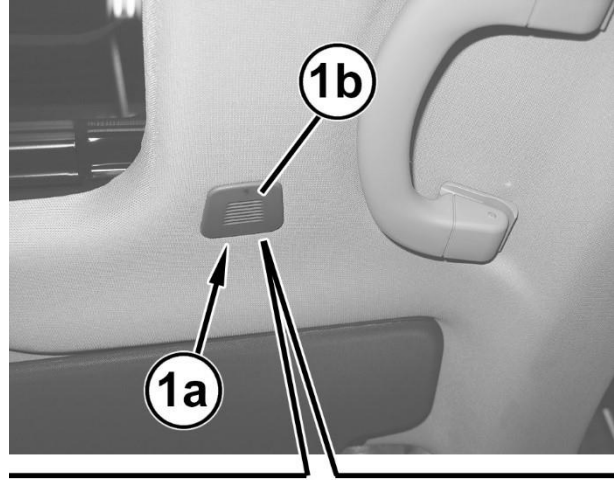

Figure 11 – Roof Lamp

Service Procedure [Continued]

33. Insert a trim stick into the front area (1a) of the hands-free system microphone (1b) and release its flexible retainer (1c). Then detach the microphone by releasing its rigid retainer (1d) (Figure 12).



34. Remove the foam covering (2a) and disconnect the electrical connection (2b) underneath (Figure 12).

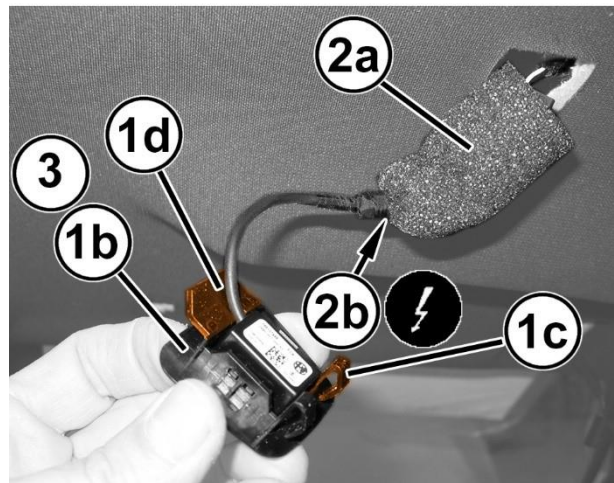

35. Remove the microphone (1b) (Figure 12).

Figure 12 – Microphone

Service Procedure [Continued]

36. Release the cover (1a) of the B-pillar trim (1b) and remove the screw (2a) (Figure 13).

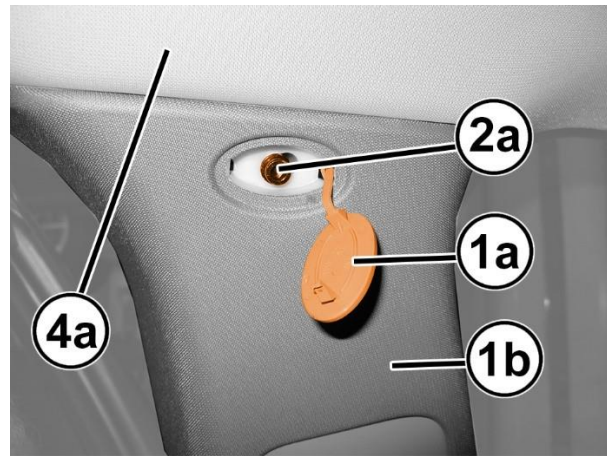

37. Release the lower retainers (3a) of the B-pillar trim (1b) using a trim stick C-4829A (1823015000) or equivalent (Figure 13).

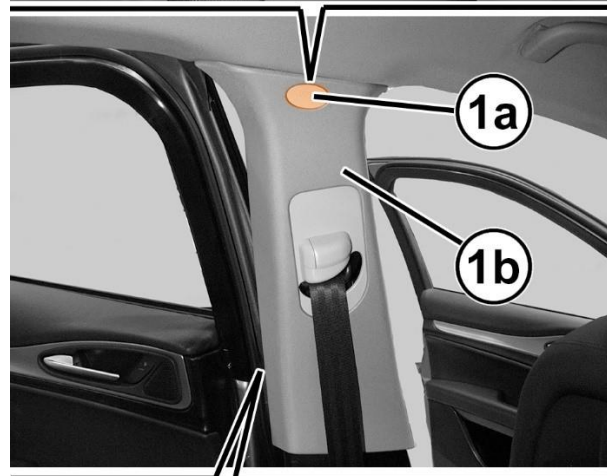

38. Working carefully and making sure not to bend the roof lining (4a), lower the B-pillar trim (1b), releasing it from its retaining profile (4b) (Figure 13).

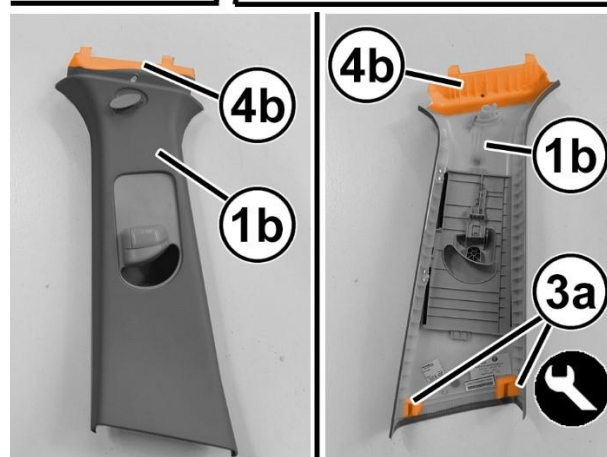

Figure 13 – B-Pillar Trim

Service Procedure [Continued]

39. With a suitably sized flat-blade screwdriver, turn the attachment device (1a) of the seat belt (1b) clockwise to the end of travel (about one quarter of a turn) (Figure 14).

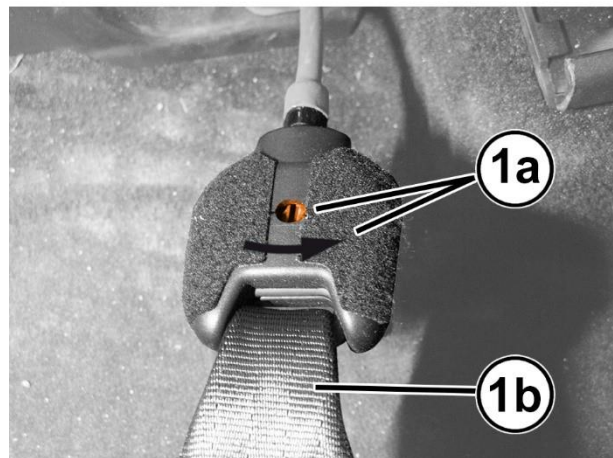
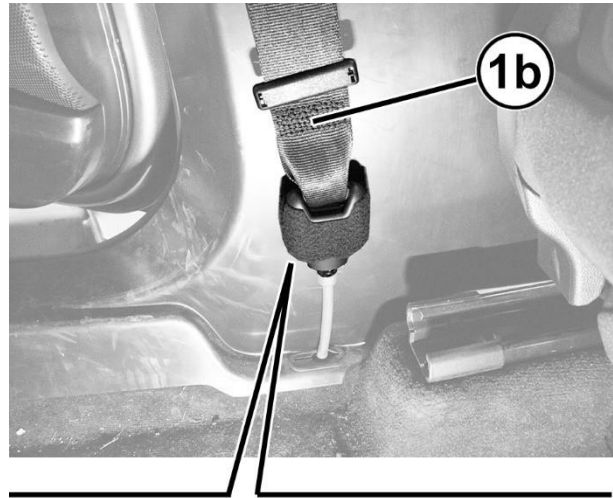

Figure 14 – Seat Belt

40. Separate the seat belt end (1a) from the corresponding anchor (1b) (Figure 15).

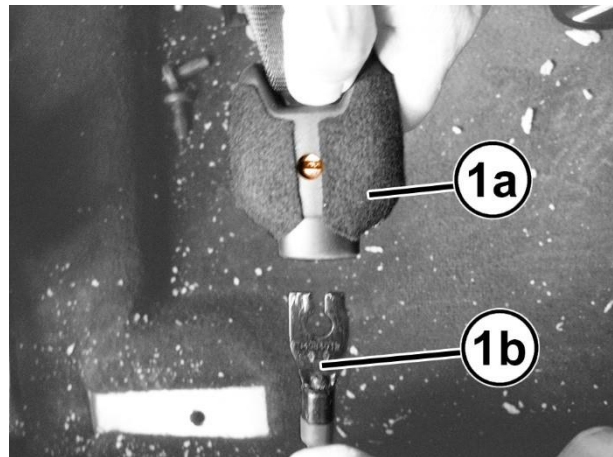

Figure 15 – Seat Belt Anchor

Service Procedure [Continued]

- 41. Remove the B-pillar trim (1a) by guiding the seat belt through the slot (1b) (Figure 16).

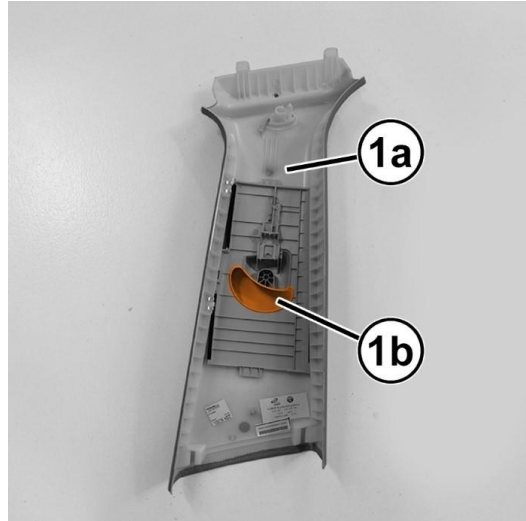
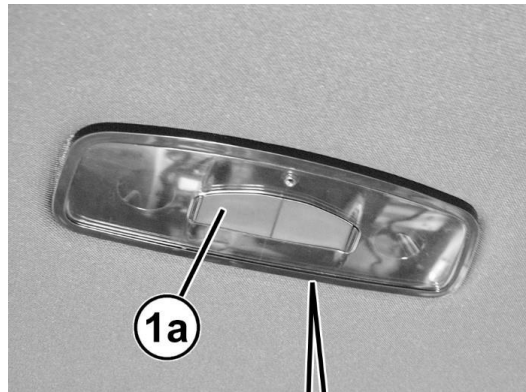

Figure 16 – B-Pillar Trim

- 42. Lower the roof lamp (1a) releasing the retainers (1b) (Figure 17).



- 43. Disconnect the electrical connection (2a) (Figure 17).

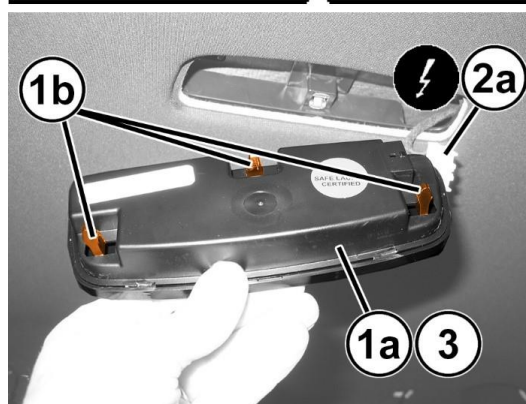
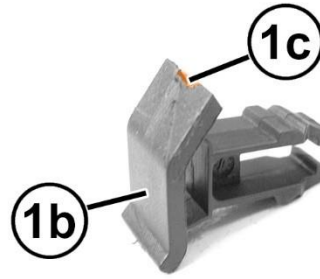

Figure 17 – Roof Lamp

- 44. Remove the roof lamp (1a) (Figure 17).

Service Procedure [Continued]

45. Remove all handles (Figure 18).



46. Lower the handle (1a) and release the covers (1b), inserting a small head screwdriver in the recess (1c) (Figure 18).

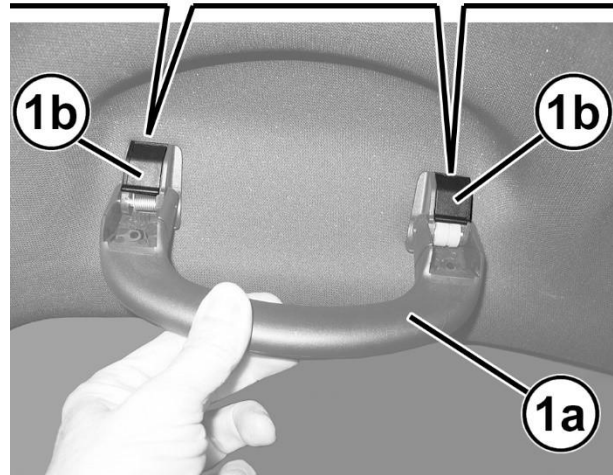

Figure 18 – Handle

47. Release the inner retainers (1a) and remove the handle (1b) (Figure 19).

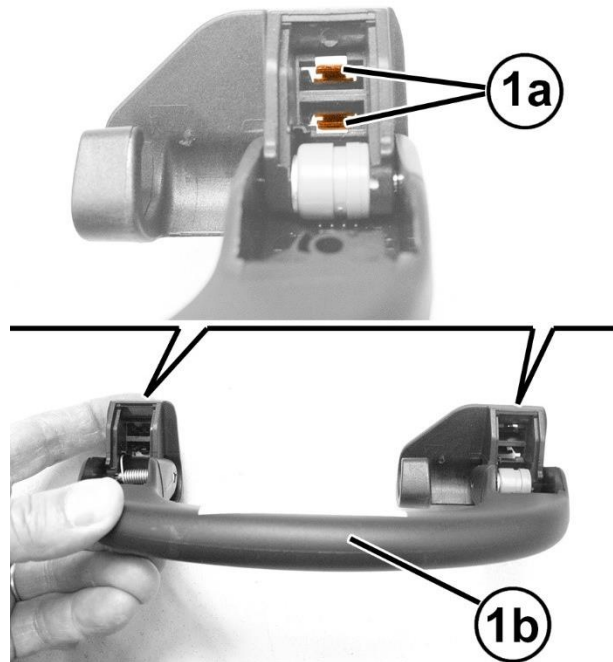

Figure 19 – Handle

Service Procedure [Continued]

48. Using a trim stick or equivalent, released the A-pillar trim retaining clips (1c) and lower the trim panel (1b) (Figure 20).

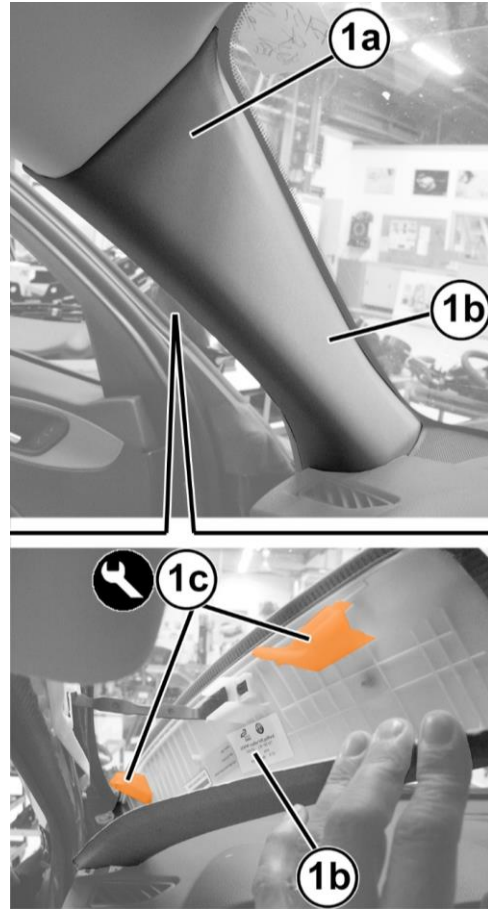

Figure 20 – A-Pillar Trim

49. Using a small flat bladed tool, remove the white cap to release the tether clip (1a) and pull it out from the bottom (1b), then remove the A-pillar trim panel (1c) (Figure 21).

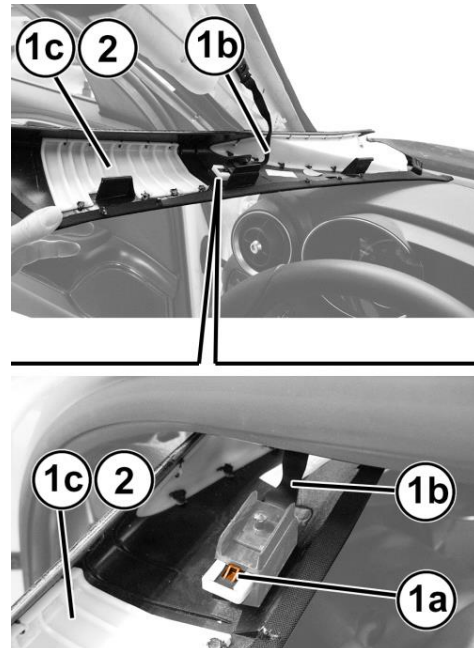

Figure 21 – A-Pillar Trim Tether

Service Procedure [Continued]

50. Working on the front left A-pillar, disconnect the electrical connector (1a) joining the roof wiring (Figure 22).

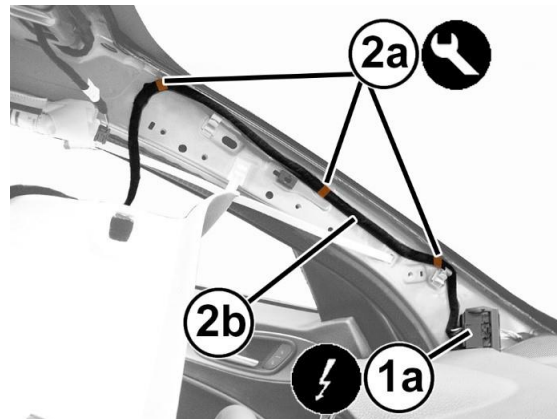

Figure 22 – Electrical Wiring

51. Release the retainers (2a) of the wiring (2b), using a trim stick C-4829A (1823015000) or equivalent (Figure 22).

52. Release the roof lining (1a) from the weather strips (1b) of the door frames and from the weather strips (1c) of the tailgate frame, then lower it inside the vehicle (Figure 23).

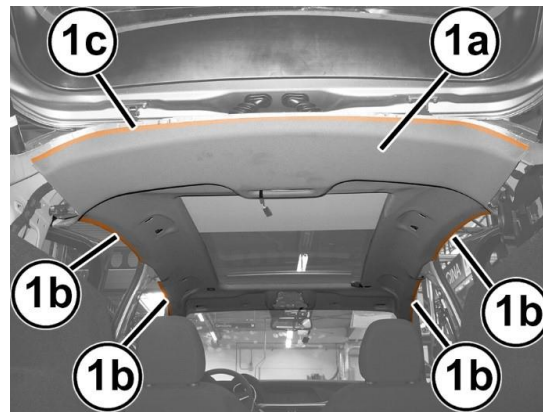

Figure 23 – Roof Lining Weather Strips

53. With the aid of a second operator, remove the roof lining (1a) from the vehicle, passing it through the tailgate frame the position shown in (Figure 24).

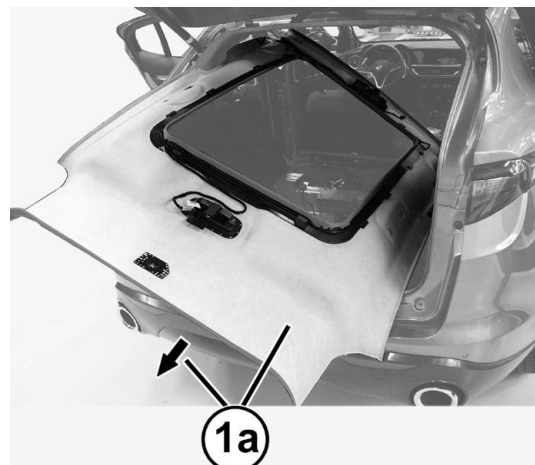

Figure 24 – Roof Lining

Service Procedure [Continued]

WARNING: To avoid serious or fatal injury, at no time should any source of electricity be permitted near the inflator of a non-deployed air bag. When carrying a non-deployed air bag, the air bag cushion side of the unit should be pointed away from the body to minimize injury in the event of an accidental deployment. If the air bag unit is placed on a bench or any other surface, the air bag cushion side of the unit should be facing such as to minimize movement in the event of an accidental deployment.

All damaged, ineffective or non-deployed air bags which are replaced on vehicles are to be handled and disposed of properly. If an air bag or seat belt tensioner unit is non-deployed, refer to the Hazardous Substance Control System for information regarding the potentially hazardous properties of the subject component and the proper safe handling procedures. Then dispose of all non-deployed and deployed air bags and seat belt tensioners in a manner consistent with state, provincial, local and federal regulations.

54. Release the front end (1a) of the tether (1d) of the side curtain air bag module (1b) from the pillar by releasing the tabs (1c) (Figure 25).
55. Release the tether (1d) from the retainer (2a) (Figure 25).
56. Remove the screws (3a) securing the front part of the side curtain air bag module (1b) (Figure 25).

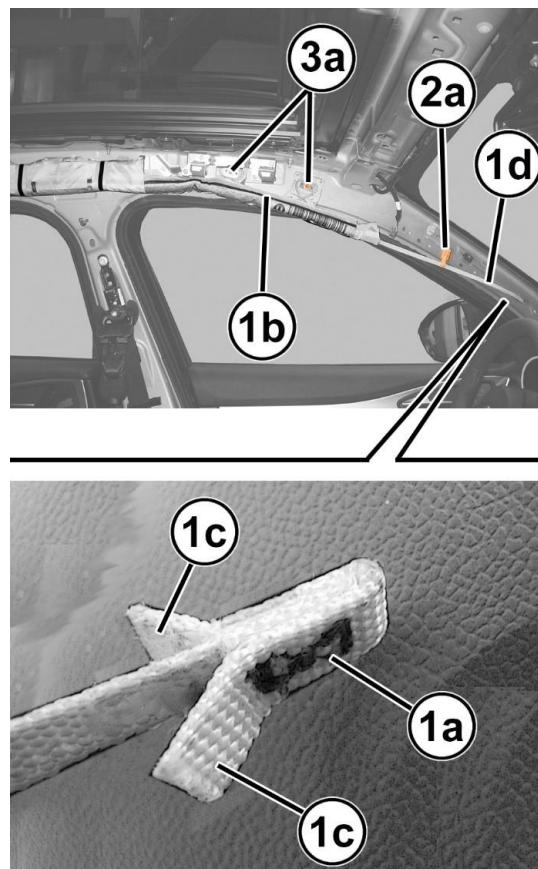

Figure 25 – Side Curtain Air Bag

Service Procedure [Continued]

57. Disconnect the electrical connection (1a) from the side curtain air bag module (1b) (Figure 26).

58. Remove the screws (2a) securing the rear of side curtain air bag module (1b) (Figure 26).

59. Release all the retainers (3a) for the side curtain air bag module (1b) from their housings (3b) on the vehicle, on both the rear and front (Figure 26).

60. Remove the side curtain air bag module (1b) after disengaging its retainer (4a) from its housing (4b) (Figure 26).

61. No parts return required. Manage the original side curtain air bag inflators using locally approved methods, so that they are properly scrapped.

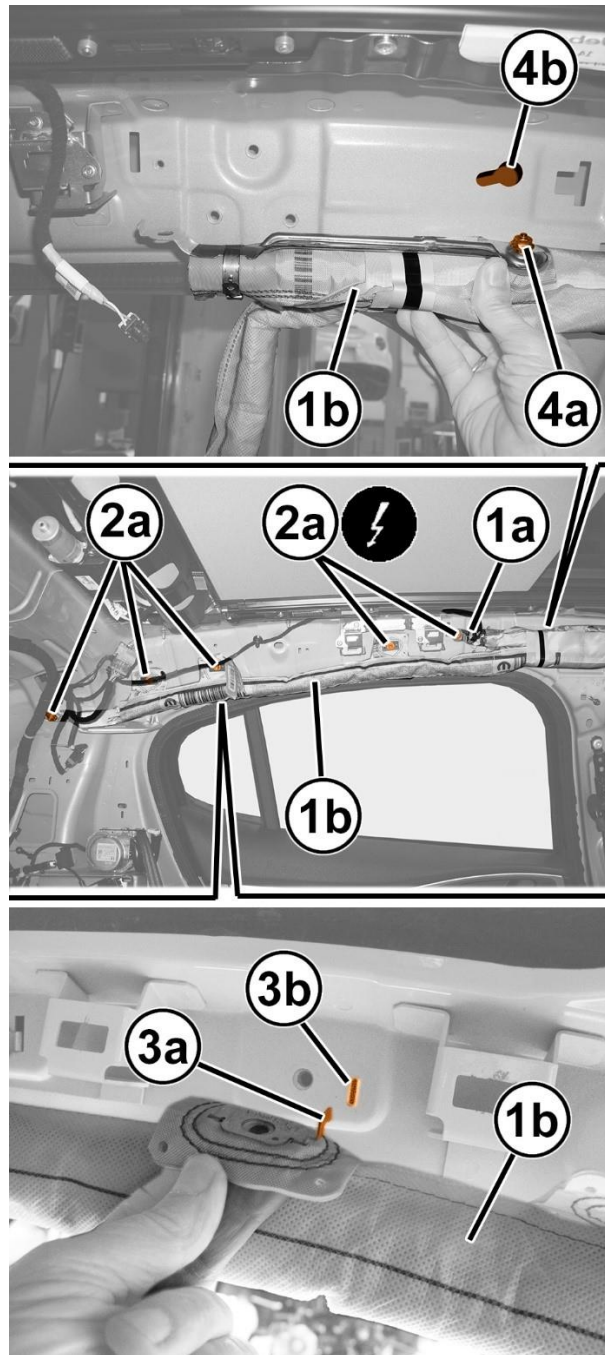

Figure 26 – Side Curtain Air Bag

Service Procedure [Continued]

B. Side Curtain Air Bag Installation

1. Handle the NEW side curtain air bag module very carefully. Make sure that the vehicle battery is disconnected.

2. Engage the retainer (1a) for the side curtain air bag module (1b) in its housing (1c) on the vehicle (Figure 27).

3. Install the side curtain air bag module (1b) and engage all its retainers (2a) to their housings (2b) on the vehicle, both rear and front (Figure 27).

4. Install the screws (3a) at the rear part of the side curtain air bag module then tighten them to 9 N·m (80 in. lbs.) (Figure 27).

5. Connect the electrical connection (4a) to the side curtain air bag module (1b) (Figure 27).

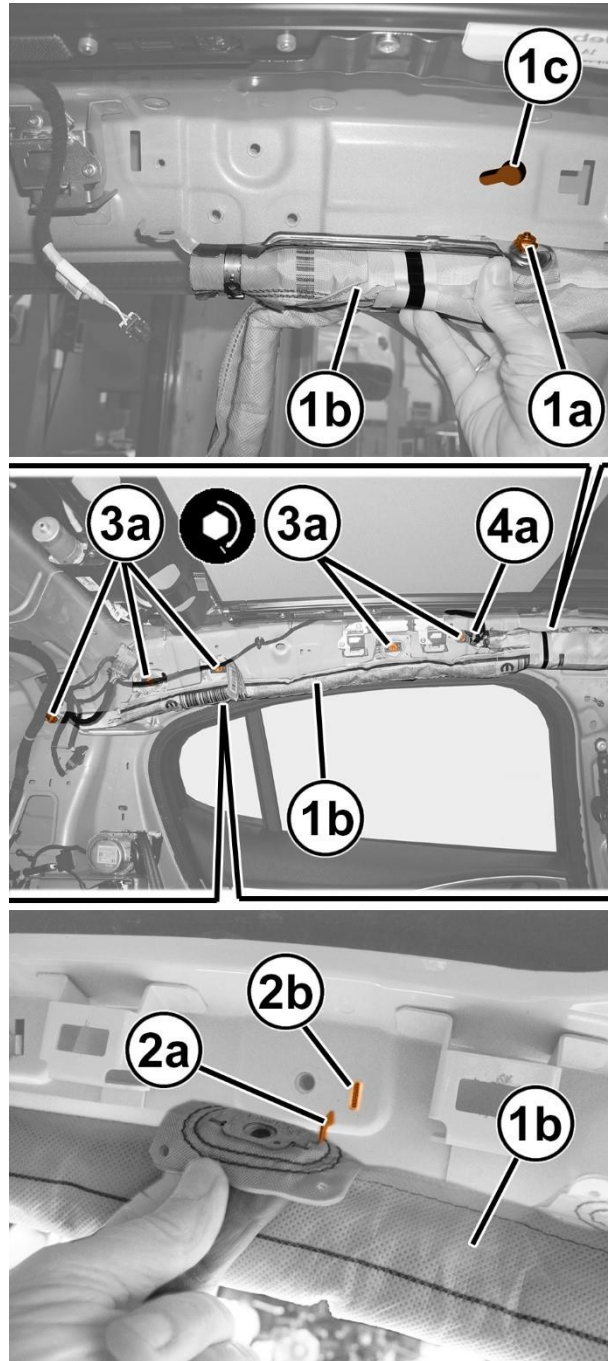

Figure 27 – Side Curtain Air Bag

Service Procedure [Continued]

6. Install the screws (1a) at the front part of the side curtain air bag module (1b) then tighten them to 9 N·m (80 in. lbs.) (Figure 28).
7. Engage the front stay (2a) to the retainer (2b) (Figure 28).
8. Engage the terminal in its housing (3a) with tabs (3b) of the side curtain air bag module from the front stay (Figure 28).
9. With the aid of a second operator, insert the roof lining in the vehicle, making it pass through the tailgate area, in the position shown in (Figure 24).
10. Install the roof lining, then engage it in the weather strips of the door frame and in the weather strip of the tailgate frame (Figure 23).
11. Working on the left front pillar, connect the electrical connection joining the roof wiring and engage the wiring retainers (Figure 22).
12. Install the tether to the A-pillar trim panel, making sure it is engaged fully and install the white clip (Figure 21).
13. Starting at the bottom of the A-pillar trim panel, align the retaining clips and hand tap to engage (Figure 20).
14. Position the grab handle in place and engage the retaining clips (1a) (Figure 19) then install the retainer covers (1b) (Figure 18).

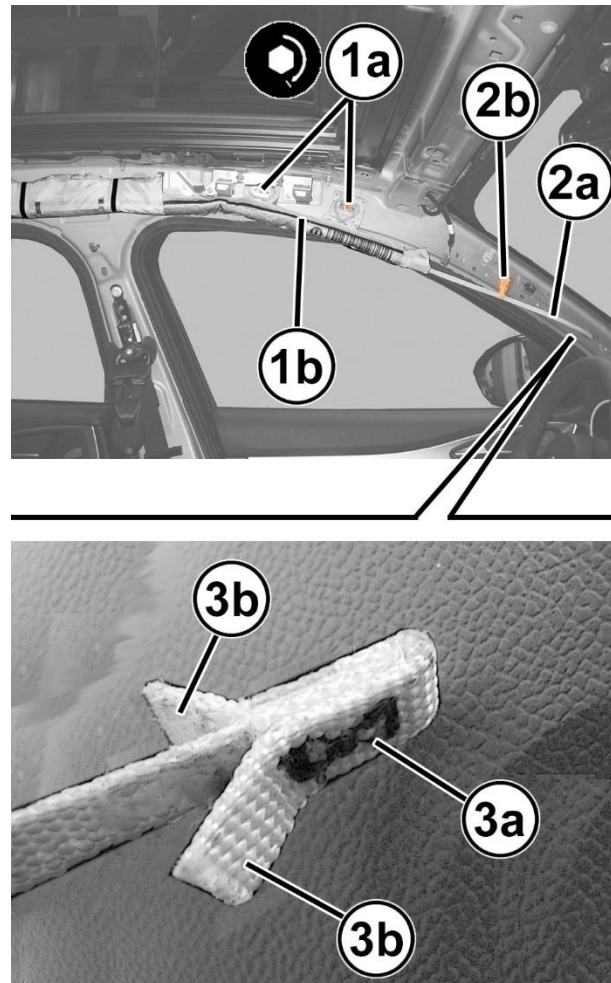
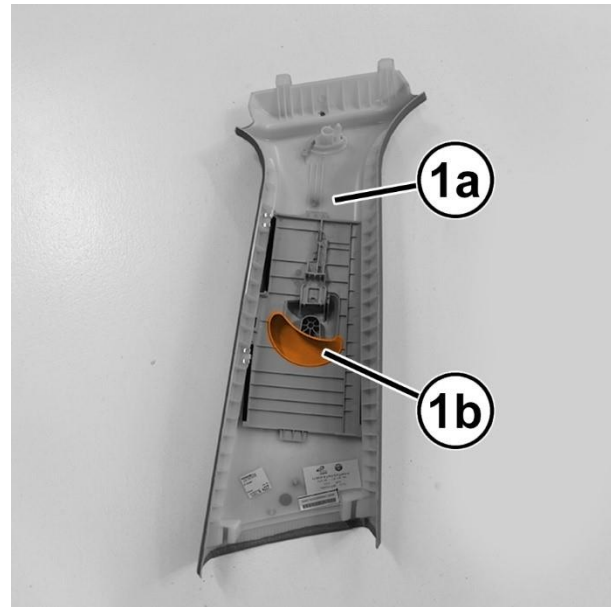

Figure 28 – Side Curtain Air Bag

Service Procedure [Continued]

15. Connect the electrical connection of the roof lamp, position it in its housing and engage the retainers (Figure 17).
16. Check that the B-pillar trim panel (1a) is not damaged (Figure 29).
17. Guide the seat belt through the slot (1b) in the B-pillar trim panel (1a) (Figure 29).
18. Fully insert the anchor (1a) into the seat belt end (1b) allowing it to connect (Figure 30).

**Figure 29 – B-Pillar Trim**

CAUTION: Check that the anchor (1a) is securely connected to the seat belt end (1b) by pulling on the belt (Figure 30).

19. Operating carefully and making sure not to bend the roof lining (4a), insert the profile (4b) of the B-pillar trim panel (1b) into the housing (Figure 13).
20. Engage the lower inner retainers of the B-pillar trim panel then install and tighten the screw and engage the screw cover (Figure 13).

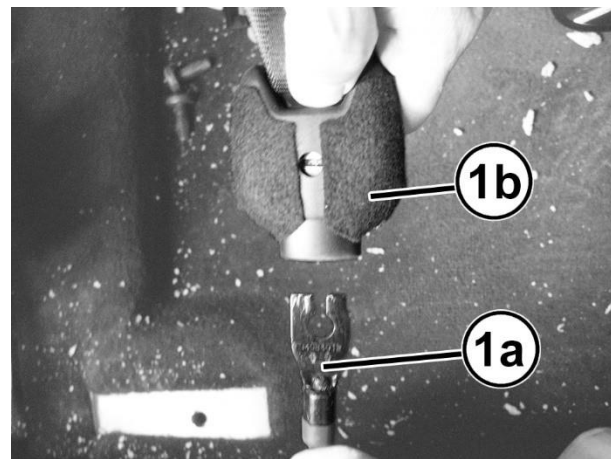
**Figure 30 – Seat Belt Anchor**

21. Connect the electrical connection of the hands-free microphone, then apply its foam covering protection (Figure 12).
22. Insert the wiring harness into place, then install the hands-free system microphone and engage its retainers (Figure 12).

Service Procedure [Continued]

- 23. Connect the electrical connection to the roof lamp (Figure 11).
- 24. Install the front roof lamp in position and engage the inner retainers (Figure 11).
- 25. Install the sun visor retainers in place then tighten the screws and engage the covers (Figure 10).

- 26. Connect the electrical connection (2a) of the sun visor, then apply its foam covering protection, insert the wiring and install the sun visor in its housing (Figure 9).

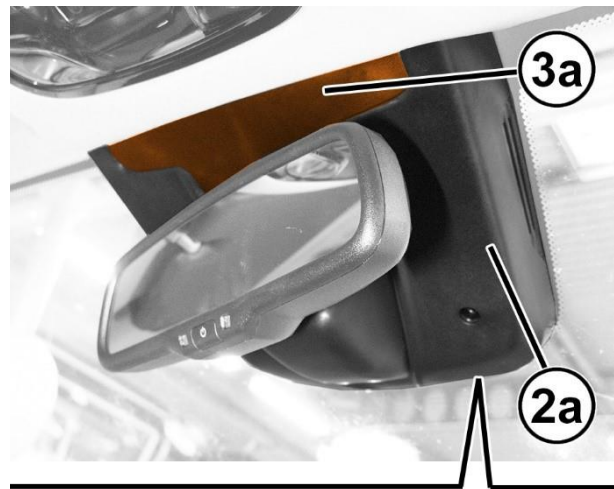

- 27. Tighten the screw (3a) then engage the cover (2a) and engage the sun visor to the retaining clip (1b) (Figure 8).

- 28. Install the sensor (1a) in its housing and engage the four retainers (1b) (Figure 31).

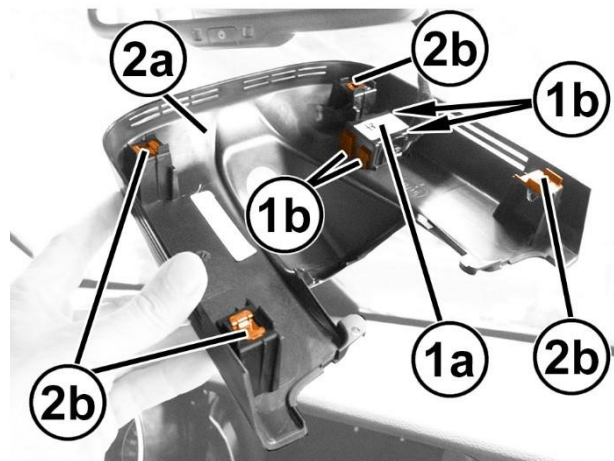

- 29. Install the outer mirror trim (2a) and engage its retainers (2b) (Figure 31).

- 30. Install the mirror trim (3a) and engage its retainers (Figure 31).

Figure 31 – Mirror Trim

Service Procedure [Continued]

- 31. Check that the C-pillar trim panel (2a) is not damaged (Figure 32).
- 32. Install the cable end (4b) and clip the cable ferrule (4a) of the rear seat backrest release handle cable (1c) to the C-pillar trim panel (Figure 32).

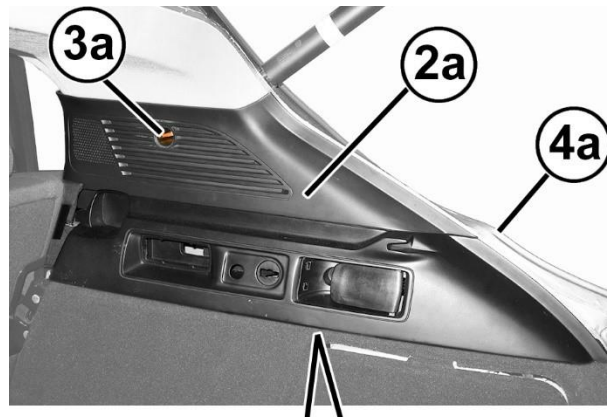

- 33. Install the C-pillar trim panel (2a) and engage the various inner retainers (2b) (Figure 32).

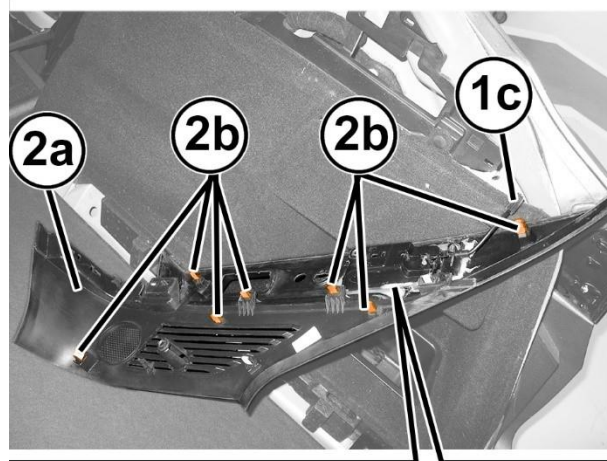

- 34. Tighten the screw (3a) and then engage the cover (Figure 32).

- 35. Engage the tailgate frame weather strip (4a) (Figure 32).

- 36. Connect the electrical connection of the power socket, insert the power socket in its housing respecting the mandatory position and close the cover (Figure 5).

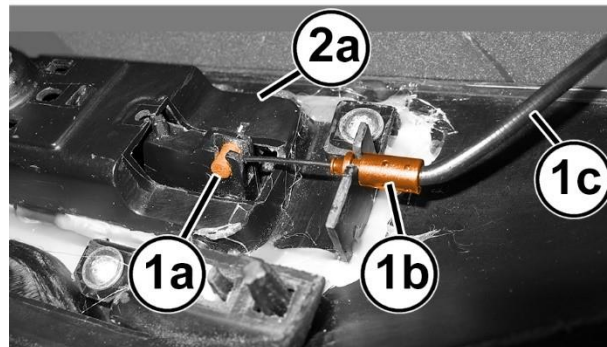

- 37. Connect the electrical connection of the roof lamp, install the roof lamp in its housing and engage the retainers (Figure 4).

Figure 32 – C-Pillar Trim Panel

- 38. Install the cargo cover and engage its movable ends into the cargo area attachment locations (Figure 3).

Service Procedure [Continued]

39. Check that the rear seat bolster (1b) is not damaged (Figure 33).
40. Guide the seat belt (1a) through the slot then install the rear seat bolster (1b) and engage the retainers (1c) (Figure 33).
41. Guide the seat belt (1a) through the slot in the seat belt bezel (2a) then engage the retainers (2b) to install the bezel on the rear seat bolster (1b) (Figure 33).
42. Do not reconnect the negative cable to the battery at this time. The Supplemental Restraint System (SRS) Verification Test procedure should be performed following service of any SRS component.

NOTE: The following procedure should be performed using the wiTECH scan tool to verify proper SRS operation following the service or replacement of any SRS component. Be certain that the wiTECH scan tool contains the latest version of the proper diagnostic software.

NOTE: During the following SRS test, the battery negative cable remains disconnected and isolated as it was during the component removal and installation procedures.

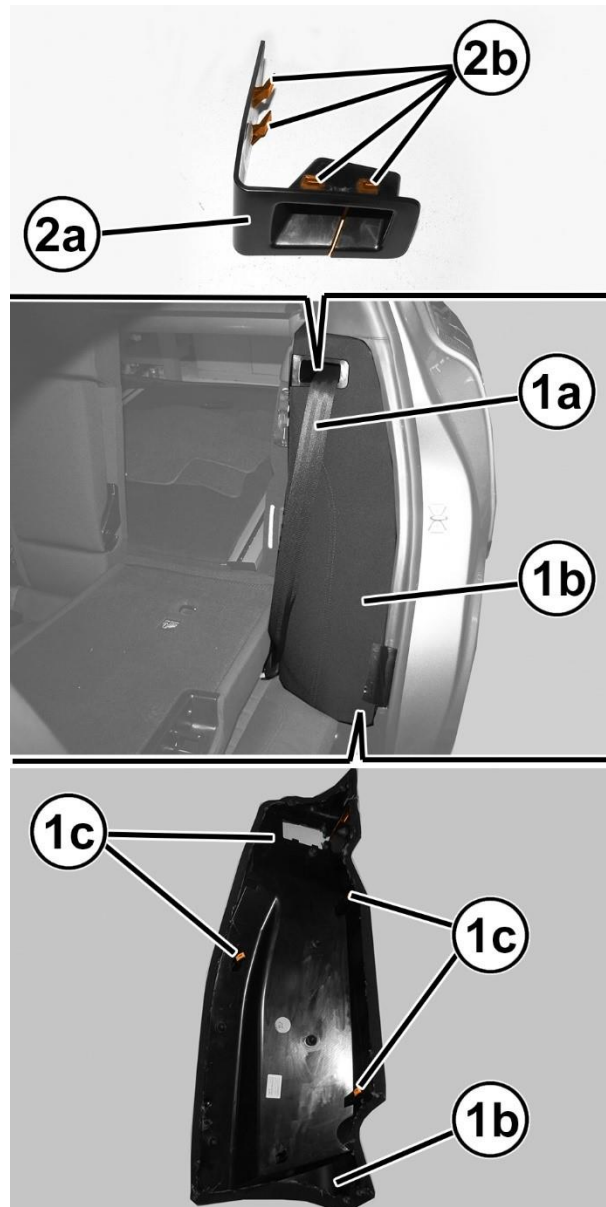

Figure 33 – Rear Seat Bolster

Service Procedure [Continued]

43. Connect the wiTECH micro pod II to the 16-way Data Link Connector (DLC). The DLC is located on the driver side lower edge of the instrument panel, near the steering column opening cover and outboard of the steering column.
44. Remove the Occupant Restraint Controller (ORC) fuses.
45. Connect the battery negative cable to the battery post and tighten the clamp nut to 5 N·m (44 in. lbs.). Connect the IBS.
46. Wait two minutes before proceeding.
47. Cycle the ignition to the on position.
48. Reconnect the ORC fuses.
49. Open the wiTECH 2.0 website.
50. Enter your “**User id**” and “**Password**” and your “**Dealer Code**”, then select “**Sign In**” at the bottom of the screen. Click “**Accept**”.
51. Starting at the “**Vehicle Selection**” screen, select the appropriate vehicle and Device Name.
52. From the “**Action Items**” screen, click “**All DTCs**”, select “**Clear All DTCs**”, click “**Continue**” and then click “**Close**”.
53. If DTCs are still stored, cycle the ignition OFF/ON to change DTC status from “**active**” to “**stored**” then clear DTCs again.

Service Procedure [Continued]

54. Turn the ignition switch to the “**OFF**” position for about 15 seconds, and then back to the “**RUN**” position. Observe the air bag indicator in the instrument cluster.
 - The air bag indicator should illuminate from four to six seconds, and then go out. This indicates that the SRS is functioning normally and that the repairs are complete.
 - If the air bag indicator fails to light or the light remains ON, there is still an active SRS fault or malfunction. Refer to the appropriate diagnostic information to diagnose the problem.
55. Move both front seats back to their customer preferred position and raise the rear seat backrests.
56. Install the headrests (1) (Figure 1).
57. Initializing the steering is required. This will be indicated by a warning light on the Instrument Panel Cluster (IPC) illuminating. Start the engine, turn the steering wheel from one lock to the other and turn it back into the center position.
58. If equipped with an electric tow hook, press and hold the button on the rear trim panel for at least 10 seconds. The LED light will turn on continuously to confirm the initialization has taken place.
59. Turn the ignition to the “**OFF**” position.
60. Close the hood and remove the wiTECH micro pod II from the DLC.
61. Return the vehicle to the customer or inventory.

Completion Reporting and Reimbursement

Claims for vehicles that have been serviced must be submitted on the DealerCONNECT Claim Entry Screen located on the Service tab. Claims paid will be used by FCA to record recall service completions and provide dealer payments.

Use the following labor operation number and time allowance:

	Labor Operation Number	Time Allowance
Replace Both Side Curtain Air Bags	23-Y1-51-82	1.8 hours
Floor Plan Reimbursement	95-95-95-97	Calculate See Below

Floor Plan Reimbursement represents the vehicle’s average daily allowance (see table below) multiplied by the number of days the vehicle was in dealer inventory and not available for sale. This reimbursement is limited to the number of days from the date of the stop sale to the date that the remedy was made available. Note: If the vehicle was received by your dealership (KZX date) AFTER the stop sale date, you will use the KZX date instead of the stop sale date. For this Recall, the stop sale was initiated on 04/07/2021 and the remedy was made available on 04/27/2021, therefore, the number of days cannot exceed 20 days.

Vehicle	Average Daily Allowance
2021 (GU) Alfa Romeo Stelvio	[REDACTED]

Add the cost of the recall parts package plus applicable dealer allowance to your claim.

NOTE: See the Warranty Administration Manual, Recall Claim Processing Section, for complete recall claim processing instructions.

Dealer Notification

To view this notification on DealerCONNECT, select “Global Recall System” on the Service tab, then click on the description of this notification.

Owner Notification and Service Scheduling

All involved vehicle owners known to FCA are being notified of the service requirement by first class mail. They are requested to schedule appointments for this service with their dealers. A generic copy of the owner letter is attached.

Vehicle Lists, Global Recall System, VIP and Dealer Follow Up

All involved vehicles have been entered into the DealerCONNECT Global Recall System (GRS) and Vehicle Information Plus (VIP) for dealer inquiry as needed.

GRS provides involved dealers with an updated VIN list of their incomplete vehicles. The owner's name, address and phone number are listed if known. Completed vehicles are removed from GRS within several days of repair claim submission.

To use this system, click on the “**Service**” tab and then click on “**Global Recall System.**” Your dealer's VIN list for each recall displayed can be sorted by: those vehicles that were unsold at recall launch, those with a phone number, city, zip code, or VIN sequence.

Dealers must perform this repair on all unsold vehicles before retail delivery. Dealers should also use the VIN list to follow up with all owners to schedule appointments for this repair.

Recall VIN lists may contain confidential, restricted owner name and address information that was obtained from the Department of Motor Vehicles of various states. Use of this information is permitted for this recall only and is strictly prohibited from all other use.

Additional Information

If you have any questions or need assistance in completing this action, please contact your Service and Parts District Manager.

Customer Services / Field Operations
FCA US LLC

This notice applies to your vehicle,

[Model Year and Model]

VIN XXXXXXXXXXXXXXXXXXXX

Y15/NHTSA 21V-221

LOGO

VEHICLE PICTURE

YOUR SCHEDULING OPTIONS

1. RECOMMENDED OPTION

Call your authorized Alfa Romeo dealership.

2. Call Alfa Romeo Premium Care at

1-866-932-3881. An agent can confirm part availability and help schedule an appointment.

3. Visit recalls.mopar.com, scan the

QR code below, or download the Mopar Owner's Companion App.

QR Code

Get access to recall notifications, locate your Alfa Romeo dealership, and more through this website or Mopar Owner's Companion App. You will be asked to provide your Vehicle Identification Number (VIN) to protect and verify your identity. The last eight characters of your VIN are provided above.

DEALERSHIP INSTRUCTIONS

Please reference Safety Recall Y15.

IMPORTANT SAFETY RECALL

Side Curtain Air Bag

Dear [Name],

This notice is sent to you in accordance with the National Traffic and Motor Vehicle Safety Act.

FCA has decided that a defect, which relates to motor vehicle safety, exists in certain [2021 Model Year (GU) Alfa Romeo Stelvio] vehicles.

It is extremely important to take steps now to repair your vehicle to ensure the safety of you and your passengers.

WHY DOES MY VEHICLE NEED REPAIRS?

The Side Air Bag Inflatable Curtain (SABIC) assembly on your vehicle ^[1] may have been built with an improperly crimped clamp. A damaged SABIC clamp may allow the cushion and inflator to separate during a SABIC deployment. **An incomplete deployment or non-deployment of the side curtain air bag increases the risk of injury in the event of a crash.**

HOW DO I RESOLVE THIS IMPORTANT SAFETY ISSUE?

FCA will repair your vehicle ^[2] free of charge (parts and labor). To do this, your dealer will replace the SABIC assembly. The estimated repair time is two hours. In addition, your dealer will require your vehicle for proper check-in, preparation, and check-out during your visit, which require more time. Your time is important to us, so we recommend that you schedule a service appointment to minimize your inconvenience. Please bring this letter with you to your dealership.

**TO SCHEDULE YOUR FREE REPAIR,
CALL YOUR ALFA ROMEO DEALER TODAY**

WHAT IF I ALREADY PAID TO HAVE THIS REPAIR COMPLETED?

If you have already experienced this specific condition and have paid to have it repaired, you may visit www.fcarecallreimbursement.com to submit your reimbursement request online. ^[3] Once we receive and verify the required documents, reimbursement will be sent to you within 60 days. If you have had previous repairs performed and/or already received reimbursement, you may still need to have the recall repair performed.

We apologize for any inconvenience, but are sincerely concerned about your safety. Thank you for your attention to this important matter.

Customer Assistance/Field Operations
Fiat Chrysler Automobiles US LLC



Mr. Mrs. Customer
1234 Main Street
Hometown, MI 48371

[1] If you no longer own this vehicle, please help us update our records. Call Alfa Romeo Premium Care at 1-866-932-3881 to update your information.

[2] If your dealer fails or is unable to remedy this defect without charge and within a reasonable time, you may submit a written complaint to the Administrator, National Highway Traffic Safety Administration, 1200 New Jersey Ave., S.E., Washington, DC 20590, or you can call the toll-free Vehicle Safety Hotline at 1-888-327-4236 (TTY 1-800-424-9153), or go to safercar.gov.

[3] You can also mail in your original receipts and proof of payment to the following address for reimbursement consideration: FCA Customer Assistance, P.O. Box 21-8004, Auburn Hills, MI 48321-8007, Attention: Recall Reimbursement.

Note to lessors receiving this recall notice: Federal regulation requires that you forward this recall notice to the lessee within 10 days.