

Combi USA

BabyRide Model #378099 Front Adjuster Retrofit Kit

Installation Instructions

Follow these instructions to replace the Front Adjuster Strap:

Removal of Front Adjuster Strap:

NOTE: When replacement of the Front Adjuster Strap is complete, shoulder harness straps **MUST** be through shoulder harness slots **at** or just **below** the child's shoulders.

1. From front of car seat, loosen harness straps by pressing down on harness adjuster lever (1) and pulling shoulder harness straps out (2) to lengthen them. Unbuckle harness buckle and chest clip (fig. a).

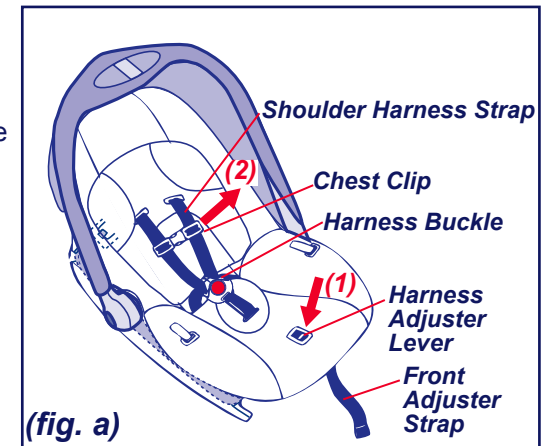

2. From bottom of car seat, lift one of the metal harness anchors from the shell (fig. b) and feed down through slot in car seat shell and seat pad (fig. c).

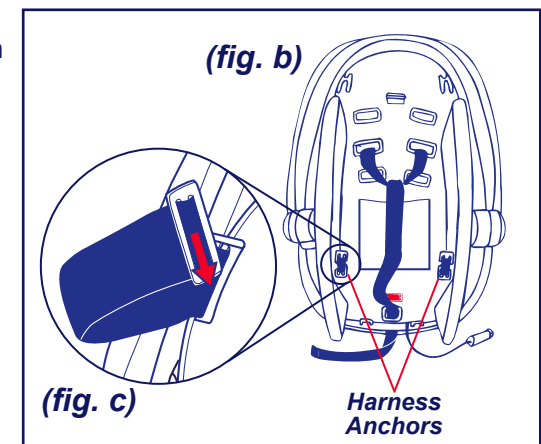

12. From back of car seat, thread harness anchor, buckle tongue, chest clip, and shoulder harness strap through adjuster strap loop (fig. l).

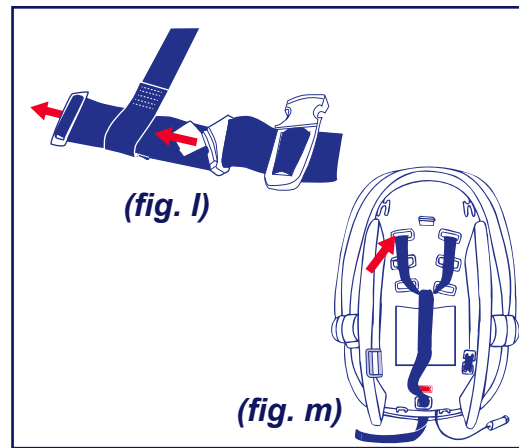

13. Thread harness anchor, buckle tongue, chest clip, and shoulder harness strap through seat back and seat pad (fig. m).

Important!

- a. Shoulder harness straps **MUST** be through shoulder harness slots that are **at** or just **below** the child's shoulders.
- b. Make sure harness straps are not twisted and are threaded through matching harness strap slot of seat pad and seat back

14. From front of car seat, rethread the harness anchor through slot in side of seat pad and car seat shell (fig. n).

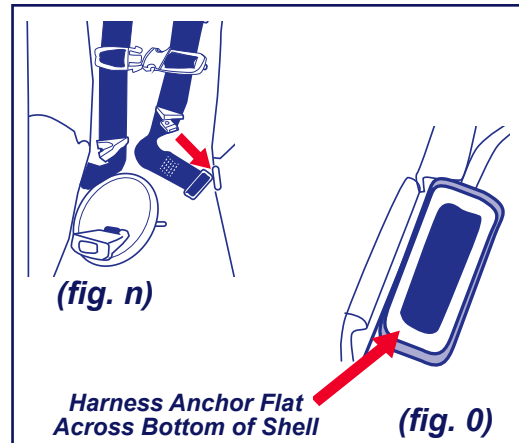

Note: Shoulder harness strap should not be twisted, and metal harness anchor should lay flat across bottom of shell (fig. o).

15. From front of car seat, check that harness is securely attached by pulling out on shoulder harness strap (fig. p).

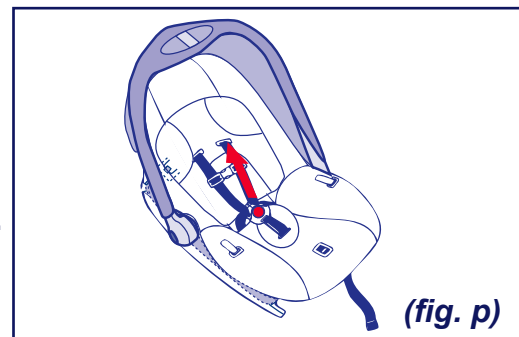

Front adjuster strap replacement is now complete.

3. From front of car seat, feed the shoulder harness strap, half of chest clip, buckle tongue, and harness anchor removed in step 2 through shoulder harness slot in seat pad and seat back (fig. d).

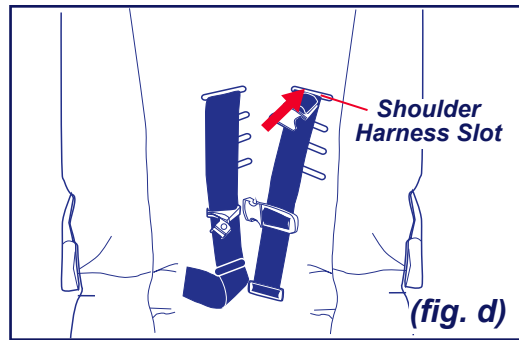

4. From back of car seat, remove the shoulder harness strap, chest clip, buckle tongue and harness anchor from the adjuster strap loop by sliding them through adjuster strap loop (fig. e).

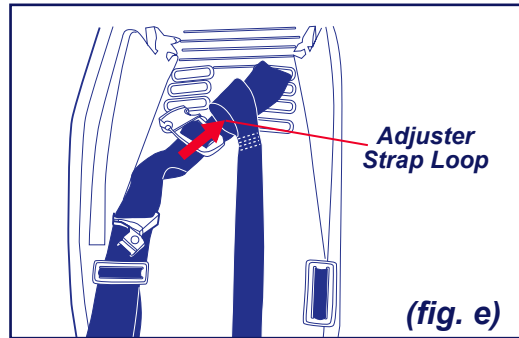

5. Cut front adjuster strap below the adjuster strap loop (fig. f) and set upper section of adjuster strap with loop aside.

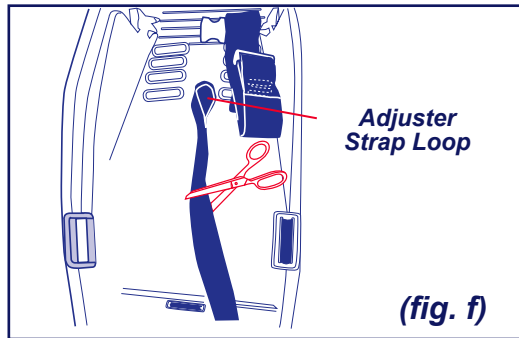

6. From front of the seat (fig. g), pull front adjuster strap completely out of the harness adjuster lever (1).

Dispose of both pieces of the front adjuster strap (2).

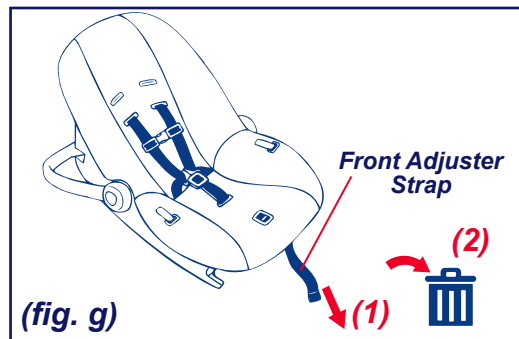

Installation of Replacement Front Adjuster Strap:

7. To install the new front adjuster strap, place the car seat on its side, and press harness adjuster lever halfway down to open a slot under the harness adjustment lever (fig. h).

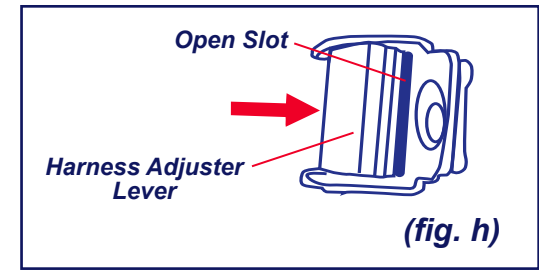

8. Position replacement front adjuster strap with cut end of sewn loop facing away from the car seat (fig. i).

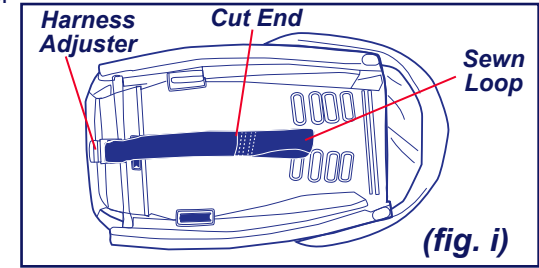

9. From bottom of car seat and while holding the harness adjuster lever halfway down, feed the non-looped end of replacement adjuster strap through the opening in the plastic on the shoulder harness slot side of the adjuster and into and through slot of the harness adjuster (fig. j).

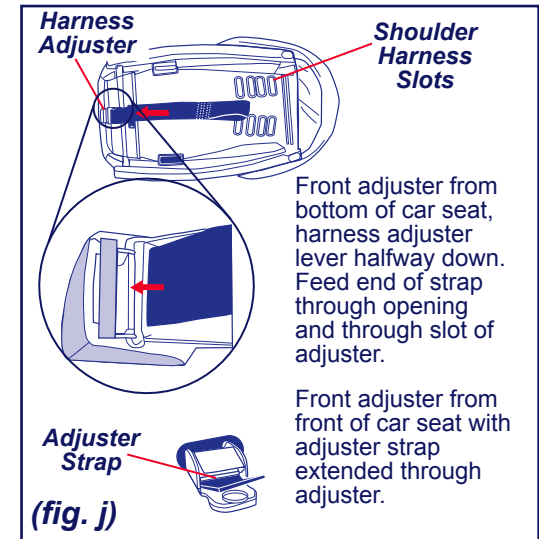

Note: Moving the harness adjuster lever up and down slightly can help feed the strap through the harness adjuster.

10. From front of car seat, pull on the non-looped end of the adjuster strap until 3 or 4 inches of the adjuster strap has been pulled through.
11. **Important!** Check that the strap is threaded through the harness adjuster correctly:
- Release harness adjuster lever.
 - From the back of the seat, pull out on the adjuster strap loop (fig. k).
- Strap should not move or slide through the front adjuster.

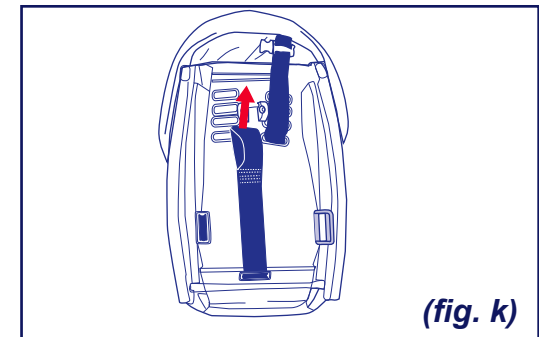

Continued on next page.