



David J. Johnson
 Director
 Service Engineering Operations
 Ford Customer Service Division

Ford Motor Company
 P. O. Box 1904
 Dearborn, Michigan 48121

December 20, 2021

TO: All U.S. Ford and Lincoln Dealers

**SUBJECT: NEW VEHICLE DEMONSTRATION / DELIVERY HOLD -
 Safety Recall 21S56**

Certain 2021 - 2022 Model Year F-150 Vehicles Equipped with Crew Cab, 145”
 Wheelbase, 4x4, 302a & Above Option Package, and One-Piece Aluminum
 Driveshaft
 Loose/Sagging Underbody Insulators

AFFECTED VEHICLES

Vehicle	Model Year	Assembly Plant	Build Dates
F-150	2021	Dearborn (DTP)	January 10, 2020 through November 20, 2021
F-150	2021	Kansas City (KCAP)	February 17, 2020 through October 21, 2021
F-150	2022	Dearborn (DTP)	October 28, 2021 through November 6, 2021
F-150	2022	Kansas City (KCAP)	October 13, 2021 through October 13, 2021

The eleventh VIN position is the assembly plant code.

- F - Dearborn Assembly (Dearborn, Michigan) = DTP
- K - Kansas City Assembly (Claycomo, Missouri) = KCAP

Affected vehicles are identified in OASIS and FSA VIN Lists.

REASON FOR THIS SAFETY RECALL

In some of the affected vehicles, underbody insulators may loosen and contact the aluminum driveshaft, resulting in marking or scoring of the driveshaft. Over time, the aluminum driveshaft may fracture, which can result in loss of motive power while driving, unintended vehicle movement while the vehicle is in park if the parking brake is not applied, and secondary damage to surrounding components. A fractured driveshaft may also contact the ground which may cause loss of control of the vehicle while driving. A fractured driveshaft increases the risk of injury or crash.

SERVICE ACTION

Before demonstrating or delivering any new in-stock vehicles involved in this recall, dealers are to secure both the driver and passenger-side underbody insulators and inspect the driveshaft, fuel vapor lines and electrical connectors for damage and repair as required. This service must be performed on all affected vehicles at no charge to the vehicle owner.

OWNER NOTIFICATION MAILING SCHEDULE

Owner letters are expected to be mailed the week of January 31, 2022. Dealers should repair any affected vehicles that arrive at their dealerships, whether or not the customer has received a letter.

PLEASE NOTE:

Federal law requires dealers to complete this recall service before a new vehicle is delivered to the buyer or lessee. Violation of this requirement by a dealer could result in a civil penalty of up to \$21,000 per vehicle. Correct all vehicles in your new vehicle inventory before delivery.

ATTACHMENTS

Attachment I: Administrative Information
Attachment II: Labor Allowances and Parts Ordering Information
Attachment III: Technical Information - Gas Engines manufactured at Dearborn Truck
Attachment IV: Technical Information - Diesel Engine
Attachment V: Technical Information - Hybrid Engine
Attachment VI: Technical Information - Gas Engines manufactured at Kansas City
Owner Notification Letter

QUESTIONS & ASSISTANCE

For questions and assistance, contact the Special Service Support Center (SSSC) via the SSSC Web Contact Site. The SSSC Web Contact Site can be accessed through the Professional Technician System (PTS) website using the SSSC link listed at the bottom of the OASIS VIN report screen or listed under the SSSC tab.

Sincerely,



David J. Johnson

NEW VEHICLE DEMONSTRATION / DELIVERY HOLD - Safety Recall 21S56

Certain 2021 - 2022 Model Year F-150 Vehicles Equipped with Crew Cab, 145" Wheelbase, 4x4, 302a & Above Option Package, and One-Piece Aluminum Driveshaft
Loose/Sagging Underbody Insulators

OASIS ACTIVATION

OASIS will be activated on December 20, 2021.

FSA VIN LISTS ACTIVATION

FSA VIN Lists will be available through <https://web.fsavinlists.dealerconnection.com> on December 20, 2021. Owner names and addresses will be available by February 18, 2022.

NOTE: Your FSA VIN Lists may contain owner names and addresses obtained from motor vehicle registration records. The use of such motor vehicle registration data for any purpose other than in connection with this recall is a violation of law in several states, provinces, and countries. Accordingly, you must limit the use of this listing to the follow-up necessary to complete this recall.

SOLD VEHICLES

- Ford has not issued instructions to stop selling/delivering or driving used vehicles under this safety recall. Owners should contact their dealer for an appointment to have their vehicles remedied as soon as practicable. Owners can continue to safely drive their vehicles.
- Immediately contact any of your affected customers whose vehicles are not on your VIN list but are identified in OASIS. Give the customer a copy of the Owner Notification Letter (when available) and schedule a service date.
- Correct other affected vehicles identified in OASIS which are brought to your dealership.
- Dealers are to prioritize repairs of customer vehicles over repairs of new and used vehicle inventory.

STOCK VEHICLES

- Correct all affected units in your new vehicle inventory before delivery.
- Use OASIS to identify any affected vehicles in your used vehicle inventory.

DEALER-OPERATED RENTAL VEHICLES

The Fixing America's Surface Transportation (FAST) Act law effective June 2016 prohibits a rental company from selling, renting or leasing vehicles subject to a safety or compliance recall. Please consult your legal counsel for legal advice.

TITLE BRANDED / SALVAGED VEHICLES

Affected title branded and salvaged vehicles are eligible for this recall.

OWNER REFUNDS

Refunds are not approved for this program.

NEW VEHICLE DEMONSTRATION / DELIVERY HOLD - Safety Recall 21S56

Certain 2021 - 2022 Model Year F-150 Vehicles Equipped with Crew Cab, 145" Wheelbase, 4x4, 302a & Above Option Package, and One-Piece Aluminum Driveshaft
Loose/Sagging Underbody Insulators

RENTAL VEHICLES

- **PASS INSPECTION:** Vehicles that pass the applicable driveshaft, fuel systems, and electrical inspections are **NOT** affected and are not approved for rental vehicles. Refer to the 21S56 technical instructions for additional information.
- **FAIL INSPECTION:** Vehicles that fail either the applicable driveshaft, fuel systems, or electrical inspections
 - **Parts are NOT available:**
 - ✓ Driveshaft, vapor line, or pigtail is on back-order.
 - ✓ PARTS ESCALATION PROCESS (Vehicle Off Road) process has been followed and COPIS ticket with VOR flagged has been submitted.
 - ✓ Prior approval is required from the SSSC, submit contact type long-term rental for consideration and approval if appropriate.
- **A ten-digit prior-approval code is required from the SSSC for rental vehicles,** a new approval code is required from SSSC every 30 days.
- If rental vehicles are needed beyond March 31, 2022, dealers will have to contact SSSC for an extension.
- Approval for all rental vehicles for this program will end on March 31, 2022.
- Follow Extended Service Plan (ESP) guidelines for dollar amounts. Prior approval is required from the SSSC.

ADDITIONAL REPAIR (LABOR TIME AND/OR PARTS)

Additional repairs identified as necessary to complete the FSA should be managed as follows:

- For related damage and access time requirements, refer to the Warranty and Policy Manual / Section 6 – Ford & Lincoln Program Policies / General Information & Special Circumstances for FSA's / Related Damage.
- For vehicles within new vehicle bumper-to-bumper warranty coverage, no SSSC approval is required, although related damage must be on a separate repair line with the "Related Damage" radio button checked.
 - Ford vehicles – 3 years or 36,000 miles
- For vehicles outside new vehicle bumper-to-bumper warranty coverage, submit an Approval Request to the SSSC Web Contact Site prior to completing the repair.

NEW VEHICLE DEMONSTRATION / DELIVERY HOLD - Safety Recall 21S56

Certain 2021 - 2022 Model Year F-150 Vehicles Equipped with Crew Cab, 145" Wheelbase, 4x4, 302a & Above Option Package, and One-Piece Aluminum Driveshaft
Loose/Sagging Underbody Insulators

CLAIMS PREPARATION AND SUBMISSION

- **Claim Entry:** Enter claims using Dealer Management System (DMS) or One Warranty Solution (OWS) online.
 - When entering claims, select claim type 31: Field Service Action. The FSA number (21S56) is the sub code.
 - For additional claims preparation and submission information, refer to the Recall and Customer Satisfaction Program (CSP) Repairs in the OWS User Guide.
- **Related Damage/Additional labor and/or parts:** Must be claimed as Related Damage on a separate repair line from the FSA with same claim type and sub code as described in Claim Entry above.

IMPORTANT: Click the Related Damage Indicator radio button.
- **Rentals:** For rental vehicle claiming, follow Extended Service Plan (ESP) guidelines for dollar amounts. Enter the total amount of the rental expense under Miscellaneous Expense code RENTAL.
- Provision for Misc. Expense: Provision for Misc. Expense: Washers as needed.
 - Program Code: 21S56
 - Misc. Expense: OTHER
 - Amount: Actual cost up to \$10.00

NEW VEHICLE DEMONSTRATION / DELIVERY HOLD - Safety Recall 21S56

Certain 2021 - 2022 Model Year F-150 Vehicles Equipped with Crew Cab, 145" Wheelbase, 4x4, 302a & Above Option Package, and One-Piece Aluminum Driveshaft
Loose/Sagging Underbody Insulators

LABOR ALLOWANCES

Description	Labor Operation	Labor Time
Retrieve DTC's (gas engine only), inspect both underbody insulators for contact with driveshaft, fuel vapor lines for gas engine and coolant sensor wiring for hybrid. Drill 2 holes (KCAP vehicles) or 5 holes (DTP vehicles) and install corresponding # of rivets and washers to secure insulators. Includes time to remove, and install or replace driveshaft	21S56B	0.9 Hours
Gas engine only - Diagnose DTC P0442 and/or P0456 (PPT and inspection) and repair damage to vapor lines caused by the underbody insulator	MT21S56C	
Hybrid only – Repair damaged coolant sensor wiring cause by underbody insulator	MT21S56D	
Time allowed to submit photos (required for driveshaft, vapor lines, electrical, underbody insulators, and other related damage)	21S56ZZ	0.2 Hours

PARTS REQUIREMENTS / ORDERING INFORMATION**SSSC Web Contact Site:**

Parts are not yet available to repair all vehicles. Until parts are available to repair all vehicles, dealers may only repair vehicles, which are customer-owned vehicles and unsold vehicles with a signed sales contact.

- To place an order for the following parts, submit a VIN-specific Part Order contact via the SSSC Web Contact Site.
- Any unsold vehicles must include a copy of the signed sales contact.

Part Number	Description	Order Quantity	Claim Quantity
W702554-S900	Rivets (Pack of 4, 5 needed per DTP vehicles, 2 needed per KCAP vehicles)	2 DTP	5 Rivets
		1 KCAP	2 Rivets

NEW VEHICLE DEMONSTRATION / DELIVERY HOLD - Safety Recall 21S56

Certain 2021 - 2022 Model Year F-150 Vehicles Equipped with Crew Cab, 145" Wheelbase, 4x4, 302a & Above Option Package, and One-Piece Aluminum Driveshaft
Loose/Sagging Underbody Insulators

Driveshaft

No remedy parts are available, a supplement will be published early 1st Quarter 2022 with remedy part information.

Only replace the driveshaft if marks are present per the technical instructions.

To place an order for a driveshaft, submit a VIN-specific Part Order contact via the SSSC Web Contact Site (photos are required showing damage):

Part Number	Description	Order Quantity
-4602-	Driveshaft (part number varies by vehicle – use Ford ECat to identify the specific part number by VIN)	As Required
N800594-S100	Driveshaft flange to pinion flange bolt (4 in package, 4 required)	1

Dealers will be notified via a DOES II communication if circumstances warrant a change in part supply strategy and when open ordering resumes.

Order the chemicals/fluids below through normal order processing channels:

Repair	Part Number	Description	Order Quantity	Claim Quantity
All	PM-13-A or Equivalent (use OSP)	Motorcraft Anti-Corrosion Coating (16 fl. Oz per container, applied to 5 rivets liberally, ½ Container per repair)	1	.5
All	TA-2-B or Equivalent (use OSP)	Motorcraft Seam Sealer (9.5 fl. Oz per container, applied to 5 rivets liberally, 1 per vehicle)	1	1
Driveshaft Replacement	XG-1-E1	Motorcraft® Premium Long-Life Grease	1	As Required
Driveshaft Replacement	XT-10-QLVC	MERCON® LV Automatic Transmission Fluid (12 per case, 1 Quart bottle required)	1	1 Quart

To guarantee the shortest delivery time, an emergency order for parts must be placed.

Obtain the parts below locally:

Part Number	Description	Quantity Needed
Obtain Locally	Zinc coated steel or Aluminum washers, ¼ inch ID, 2-inch OD, Thickness 2mm (Max).	5 needed per <u>DTP</u> Vehicle Claim as Misc. Other
		2 needed per <u>KCAP</u> Vehicle Claim as Misc. Other

NEW VEHICLE DEMONSTRATION / DELIVERY HOLD - Safety Recall 21S56

Certain 2021 - 2022 Model Year F-150 Vehicles Equipped with Crew Cab, 145" Wheelbase, 4x4, 302a & Above Option Package, and One-Piece Aluminum Driveshaft
Loose/Sagging Underbody Insulators

DEALER PRICE

For latest prices, refer to DOES II.

PARTS RETENTION, RETURN, & SCRAPPING

Follow the provisions of the Warranty and Policy Manual, Section 1 - WARRANTY PARTS RETENTION AND RETURN POLICIES. If a replaced part receives a scrap disposition, the part must be scrapped in accordance with all applicable local, state and federal environmental protection and hazardous material regulations. Federal law prohibits selling motor vehicle parts or components that are under safety, compliance, or emissions recall.

EXCESS STOCK RETURN

Excess stock returned for credit must have been purchased from Ford Customer Service Division in accordance with Policy Procedure Bulletin 4000.

REPLACED FSA PARTS INSPECTION AND SIGN OFF

Effective March 1st 2021 all parts replaced as part of an FSA repair with a repair order open date of March 1st 2021 or later must be inspected and signed off on the repair order by a member of your dealers fixed operations management team or an employee the task has been delegated to. If the task is to be delegated to a non-management employee, the employee needs to be someone other than the technician who completed the repair and needs to understand the importance of completing this task consistently and accurately.

- All parts replaced as part of an FSA repair should be returned to the parts department following the Warranty Parts Retention and Return Policies.
- Inspect the replaced parts to verify the FSA repair was completed.
- If the FSA repair is found to be complete, the designated employee signs the repair order line or parts return stamp area (electronic or hand signed) for the FSA repair indicating the parts were inspected and validated to have been replaced.
- After the parts have been inspected, they should be handled based on the guidance in the parts status report in the Online Warranty System (Hold, Return, CORE, Scrap, etc.).
- This process is subject to review during warranty audits for FSA repairs with a repair order open date of March 1st, 2021 or later. Any eligible FSA claims requiring parts replacement, found not to have been inspected and signed off during a warranty audit will be subject to chargeback and consideration for enrollment into the Dealer Incomplete Recall Repair Process.

Note: Other approvals (electronic or handwritten) for add-on repair lines, dealer owned vehicle repairs, and repeat repairs do not qualify as FSA parts inspection approvals. The post repair FSA parts inspection process (electronic or handwritten) is independent from other warranty approval requirements. The approval by the designated employee implies that the FSA parts were found to be replaced and must be able to be clearly identified on the Repair Order. If multiple FSA's require approval on a single Repair Order, each applicable occurrence will require individual post repair approval by the designated employee.

CERTAIN 2021-2022 MODEL YEAR F-150 VEHICLES EQUIPPED WITH A CREW CAB, 145" WHEELBASE, 4X4, 302A AND ABOVE OPTION PACKAGE, AND ONE-PIECE ALUMINUM DRIVESHAFT – LOOSE/SAGGING UNDERBODY INSULATORS

SERVICE PROCEDURE

GAS ENGINES – VEHICLES MANUFACTURED AT DEARBORN TRUCK ASSEMBLY PLANT

Table Of Contents

Check for DTCs.....2

Inspection.....3

Driveshaft.....3

Driver Side Insulator.....4

Vapor Line.....4

Securing Underbody Insulators.....6

Appendix A - Acceptable Photos.....9

Materials List

Ruler/Scale	13 mm (1/2 in) Drill Stop	Small Brush	M18-1/4" Rivet Gun
Drill	6.7 mm (17/64 in) Drill Bit	Marker	



NOTE: The driver side insulator is located directly above the fuel tank.

NOTE: The passenger side insulator is located directly above the exhaust.

NOTE: Insulators are highlighted for illustration purposes only.

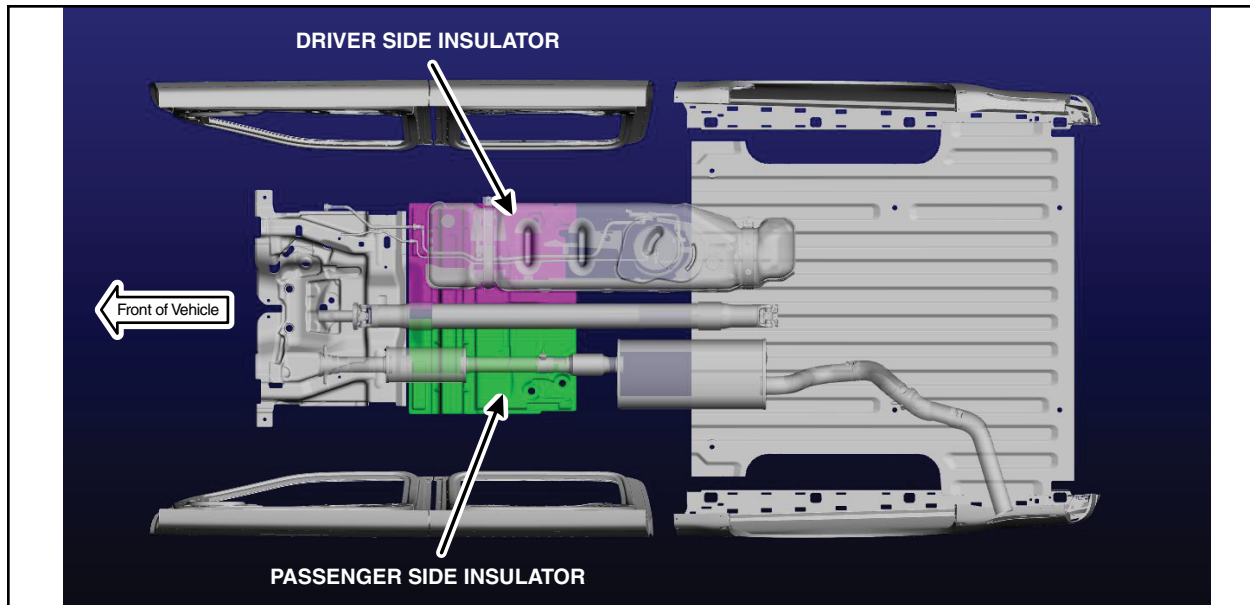

FIGURE 1

Check for DTCs

1. Using the Ford Diagnostic and Repair System (FDRS), check the Powertrain Control Module (PCM) for DTCs. Are either of the following DTC's present in the PCM, P0442 and/or P0456?

Yes - Please follow Workshop Manual (WSM) procedures for pinpoint test HX in Section 303-13, then proceed to step 2.

No - Proceed to step 2.



Inspection

2. With the vehicle in NEUTRAL, position it on a hoist. Please follow Workshop Manual (WSM) procedures in Section 100-02.
3. Remove the driveshaft. Please follow WSM procedures in Section 205-01.
4. Inspect the rear driveshaft for any marks caused by the passenger side insulator. Are there any marks present on the driveshaft due to contact from the insulator? See Figures 2 and 3.

Yes – Does not pass inspection. Contact the SSSC and provide a picture of the driveshaft with the marks. Once approved, rear driveshaft replacement will be required, but do not install at this time. Proceed to step 5.

No – Passes inspection. Proceed to step 5.

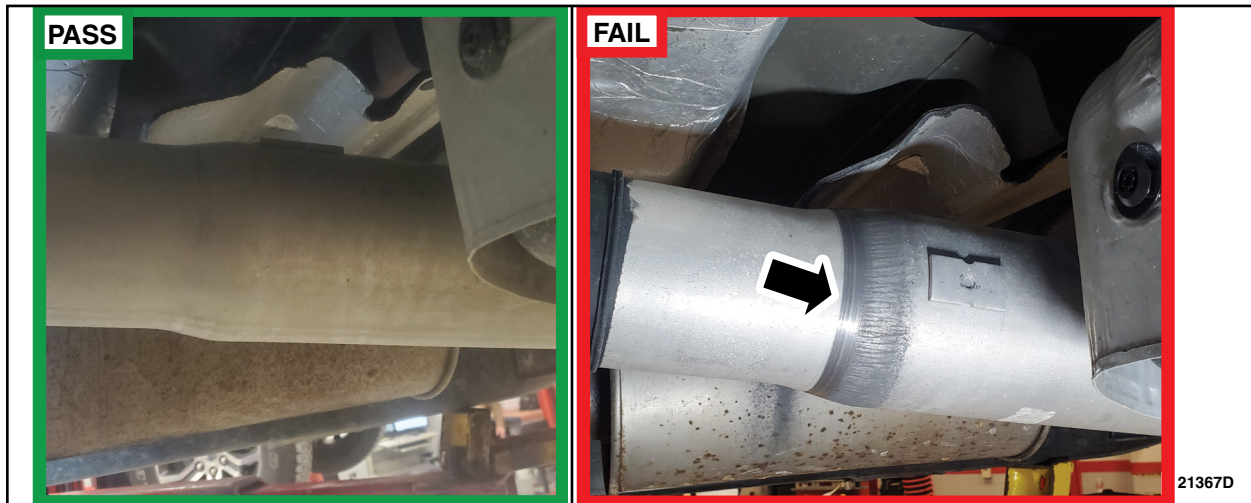

FIGURE 2



FIGURE 3



Driver Side Insulator

5. Inspect the driver side insulator for any edges hanging down or touching the fuel tank. Is the insulator hanging down or touching the fuel tank? See Figure 4.

Yes – Does not pass inspection. Proceed to step 6.

No – Passes inspection. Proceed to step 8.

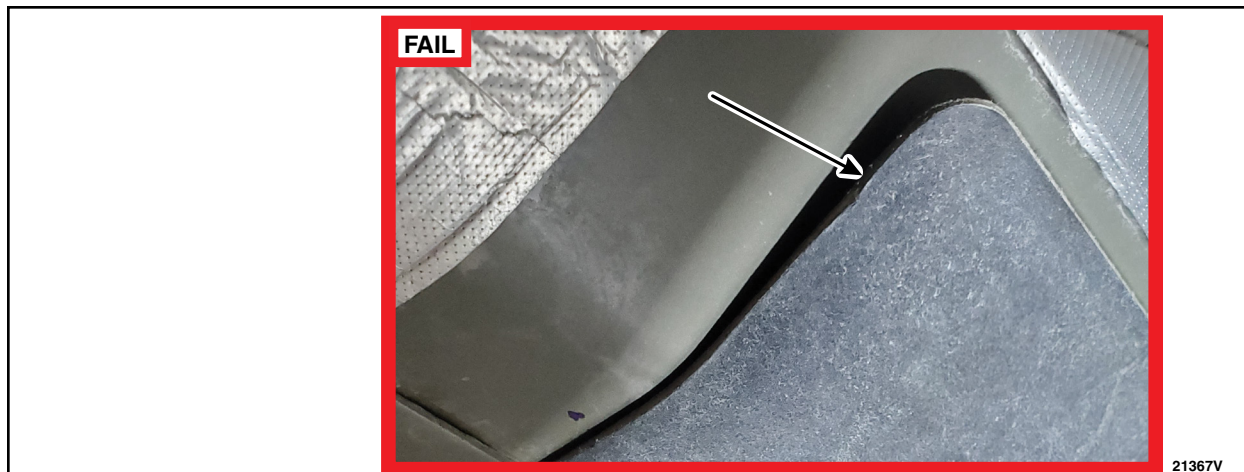

FIGURE 4

6. Remove the fuel tank to gain access to the vapor line. Please follow WSM procedures in Section 310-01.
7. Inspect the vapor line for any damage caused by the driver side insulator. Is there any damage to the line? See Figures 5 through 7.

Yes – Does not pass inspection. Replace the damaged line. Please follow WSM procedures in Section 310-01, then proceed to step 8.

No – Passes inspection. Proceed to step 8.

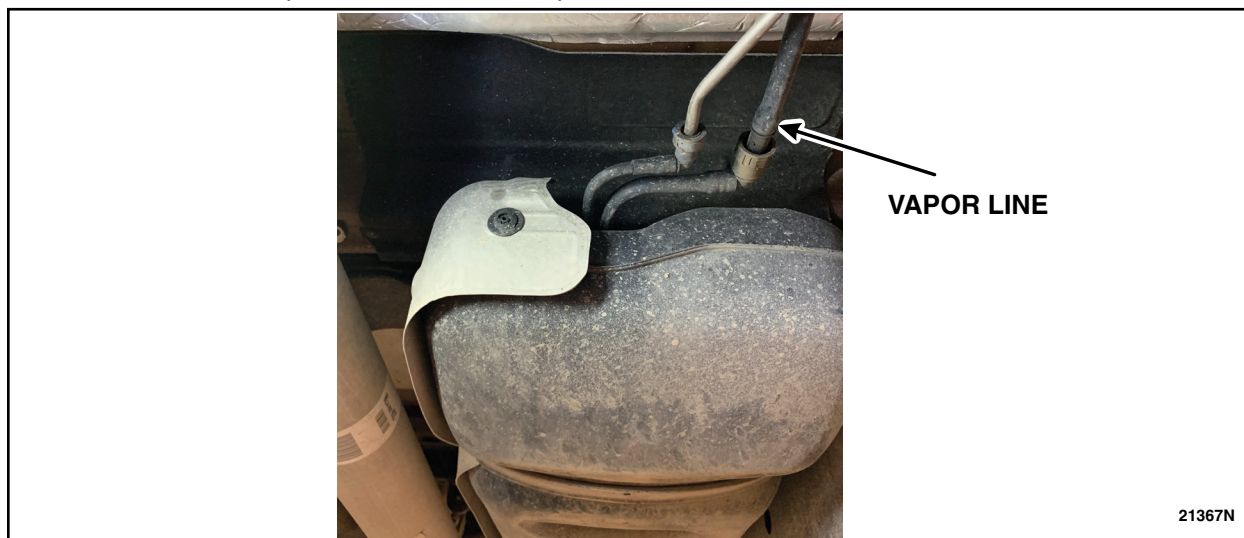

FIGURE 5



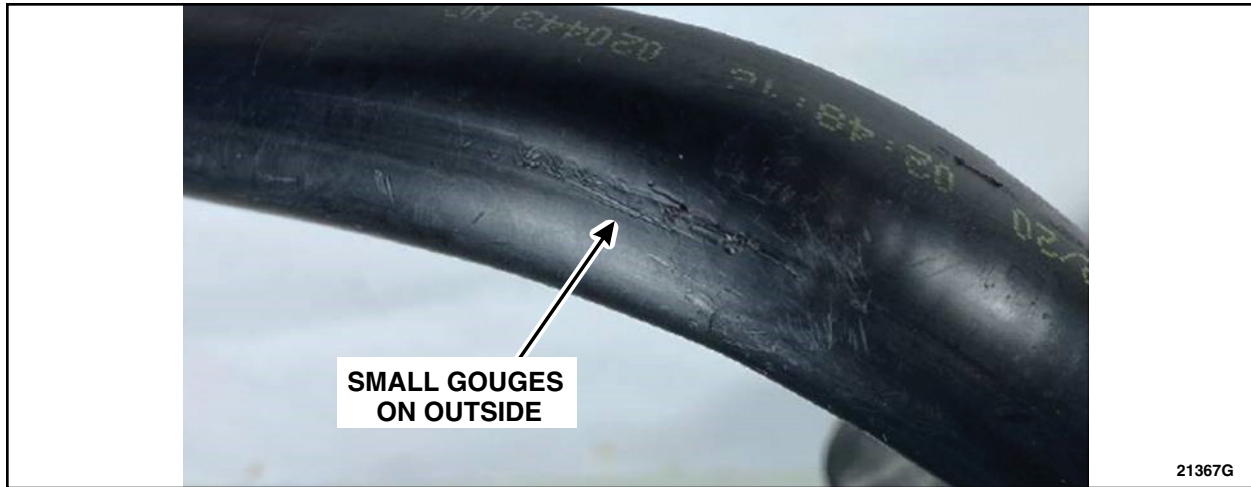

FIGURE 6



FIGURE 7



Securing Underbody Insulators

8. Measure and mark the four locations on the passenger side insulator and mark the one location on the driver side insulator. See Figures 8 and 9.

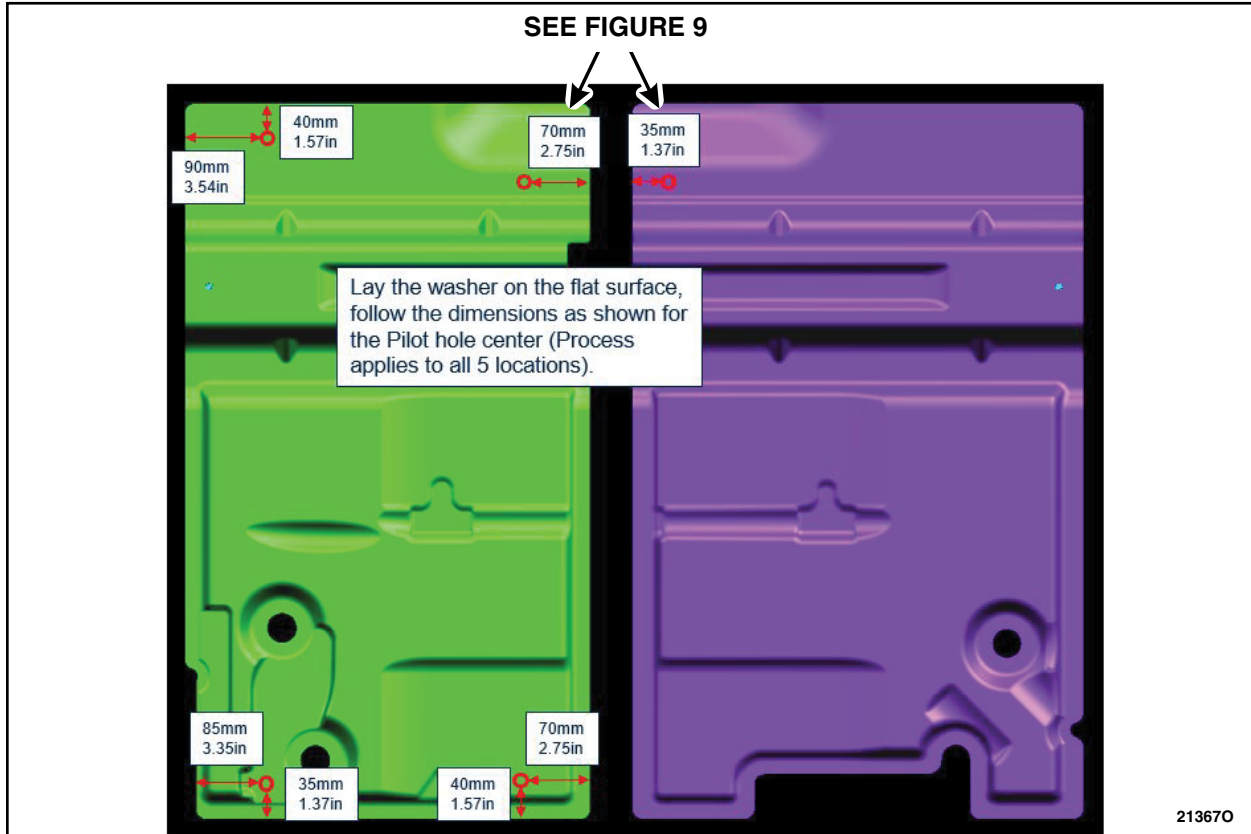

FIGURE 8

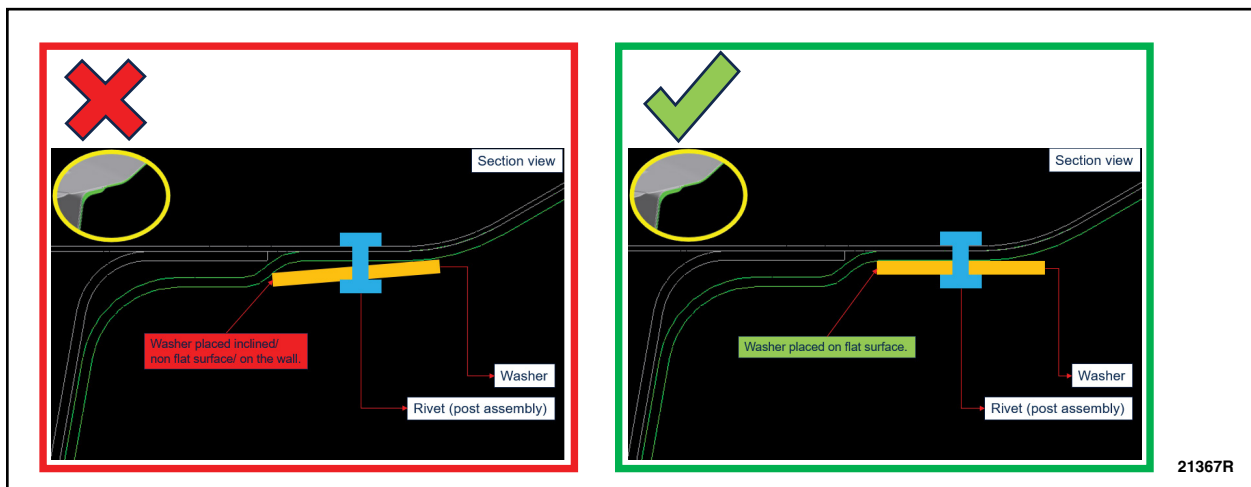

FIGURE 9



9. Using the 6.7mm (17/64 in) drill bit, drill a hole through the insulator and into the floor. See Figure 10.

NOTE: Use the 13mm (1/2 in) drill stop to ensure you do not drill through the carpet.

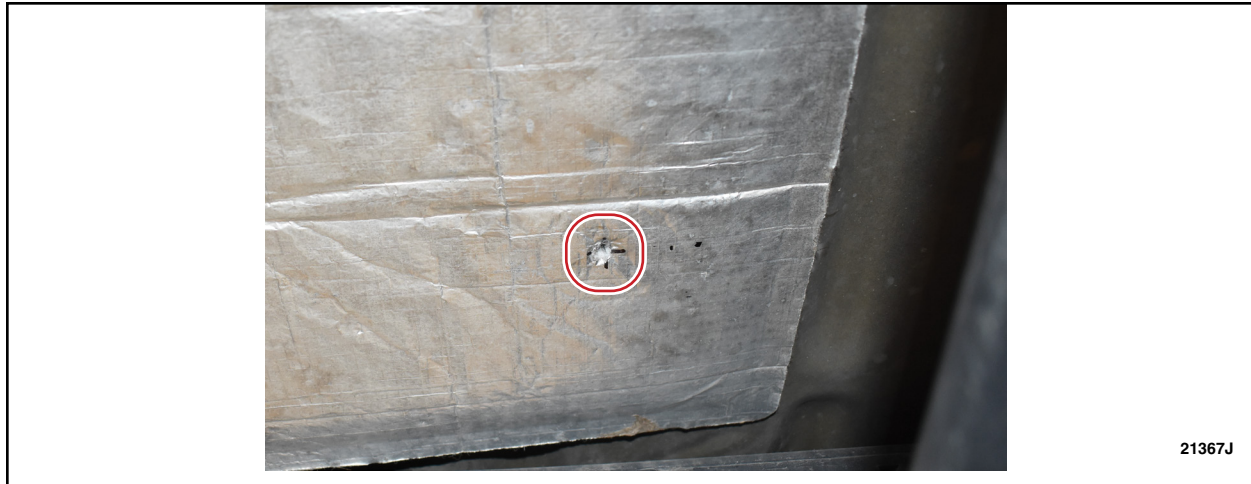

FIGURE 10

10. Repeat step 9 for the remaining four marked locations.

11. Using a small brush, apply a layer of the anti-corrosion coating to the edges of the newly drilled holes.

12. Install the washer onto the rivet. See Figure 11.



FIGURE 11



13. Apply a thick layer of seam sealer to the rivet, and the backside of the washer. See Figure 12.



FIGURE 12

14. Using a M18-1/4" rivet gun, install the rivet and washer to the drilled hole. See Figure 13.

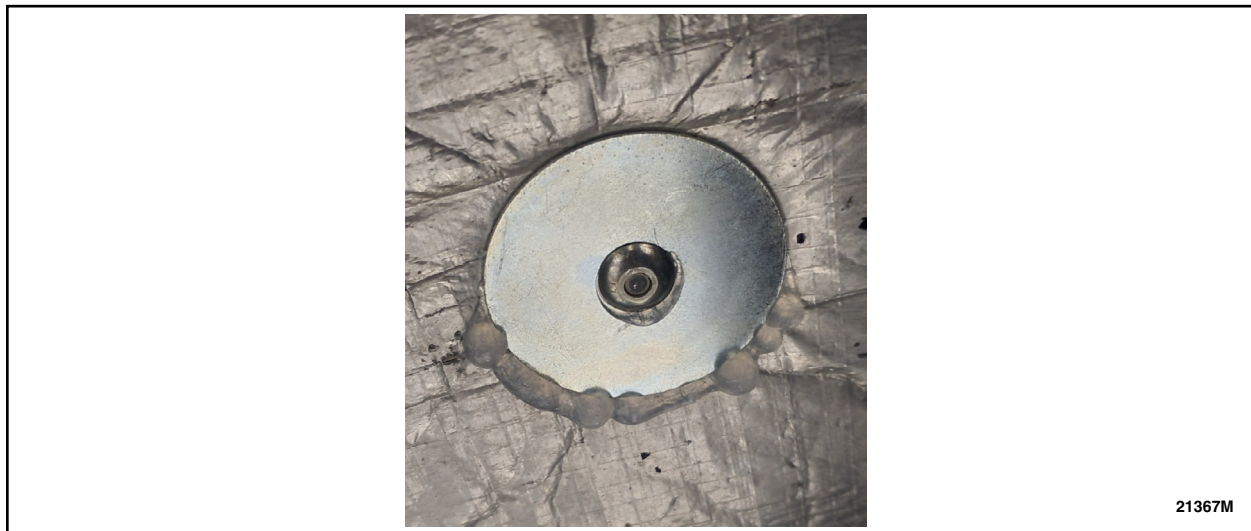

FIGURE 13

15. Using a small brush, apply a layer of the anti-corrosion coating to the washer and rivet.
16. Repeat steps 12-15 for the remaining four drilled holes.
17. Install the fuel tank if it was removed in the inspection. Please follow WSM procedures in Section 310-01.
18. Install the driveshaft. Please follow WSM procedures in Section 205-01.

NOTE: Both underbody insulators must be present to perform the above procedure.



Appendix A – Acceptable Photos

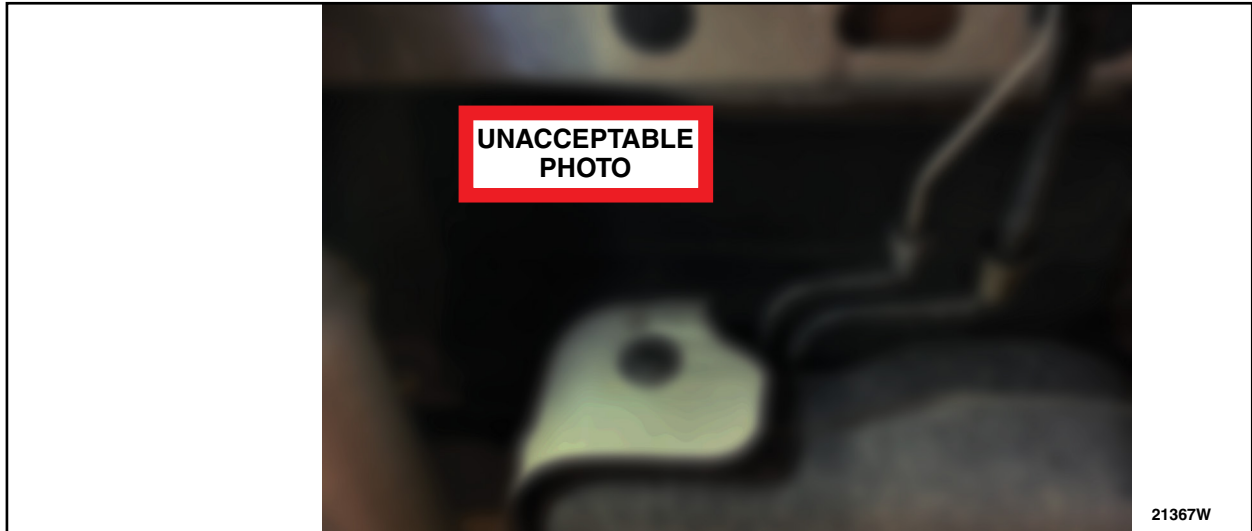

FIGURE 14



FIGURE 15





FIGURE 16



FIGURE 17



CERTAIN 2021-2022 MODEL YEAR F-150 VEHICLES EQUIPPED WITH A CREW CAB, 145" WHEELBASE, 4X4, 302A AND ABOVE OPTION PACKAGE, AND ONE-PIECE ALUMINUM DRIVESHAFT – LOOSE/SAGGING UNDERBODY INSULATORS

SERVICE PROCEDURE

DIESEL ENGINES

Table Of Contents

Inspection.....2

Driveshaft.....2

Securing Underbody Insulators.....3

Appendix A - Acceptable Photos.....6

Materials List

Ruler/Scale	13 mm (1/2 in) Drill Stop	Small Brush	M18-1/4" Rivet Gun
Drill	6.7 mm (17/64 in) Drill Bit	Marker	

NOTE: The driver side insulator is located directly above the fuel tank.

NOTE: The passenger side insulator is located directly above the exhaust.

NOTE: Insulators are highlighted for illustration purposes only.

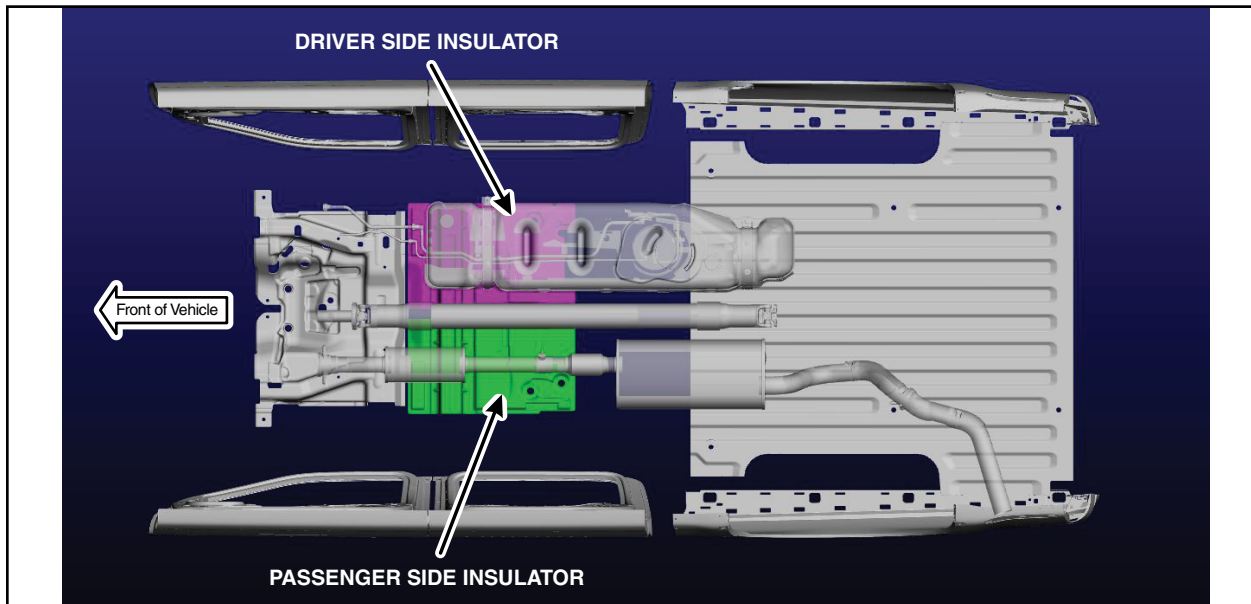

FIGURE 1



Inspection

1. With the vehicle in NEUTRAL, position it on a hoist. Please follow Workshop Manual (WSM) procedures in Section 100-02.
2. Remove the driveshaft. Please follow WSM procedures in Section 205-01.
3. Inspect the rear driveshaft for any marks caused by the passenger side insulator. Are there any marks present on the driveshaft due to contact from the insulator? See Figures 2 and 3.

Yes – Does not pass inspection. Contact the SSSC and provide a picture of the driveshaft with the marks. Once approved, rear driveshaft replacement will be required, but do not install at this time. Proceed to step 4.

No – Passes inspection. Proceed to step 4.

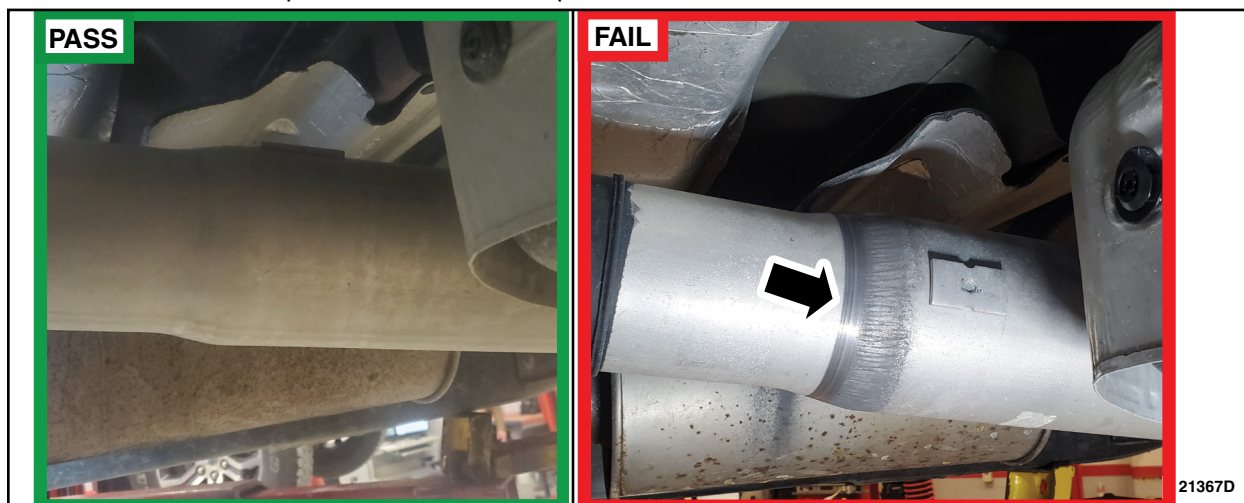

FIGURE 2



FIGURE 3



Securing Underbody Insulators

4. Measure and mark the four locations on the passenger side insulator and mark the one location on the driver side insulator. See Figures 4 and 5.

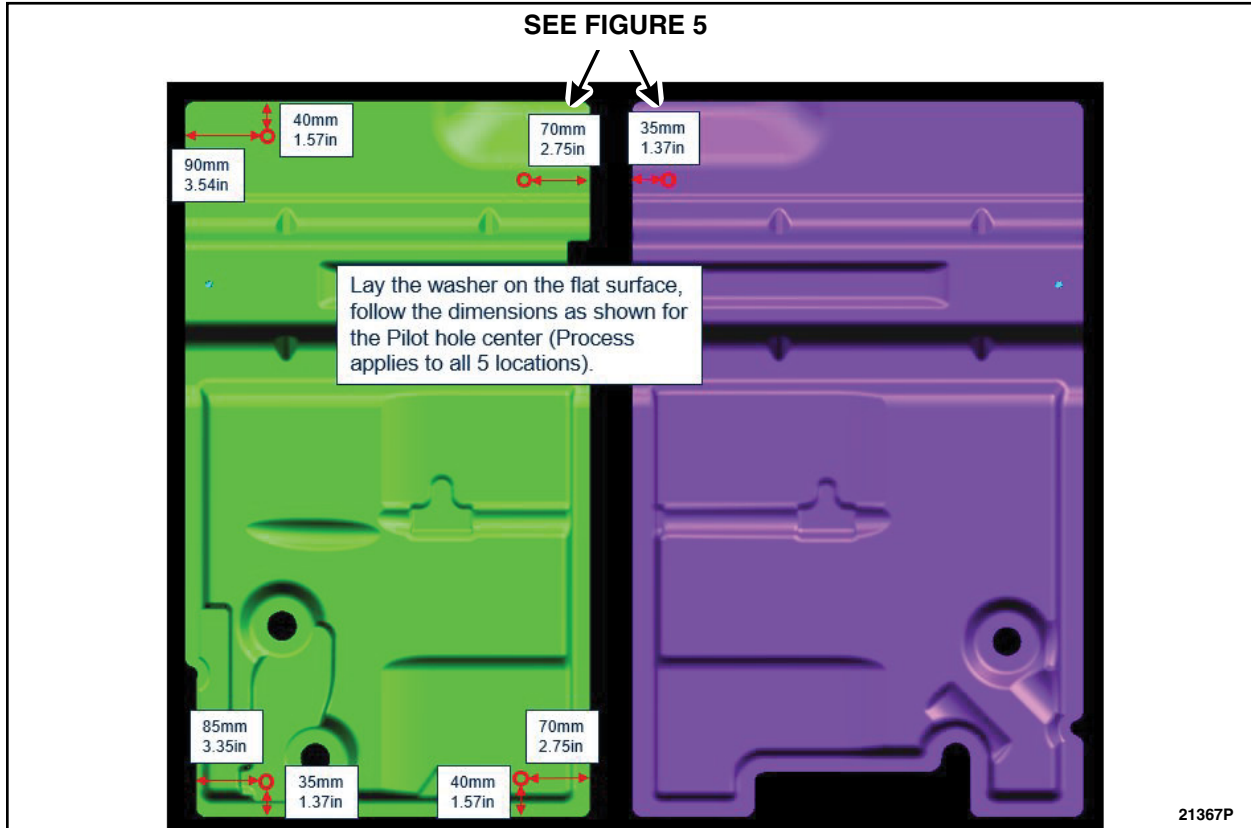

FIGURE 4

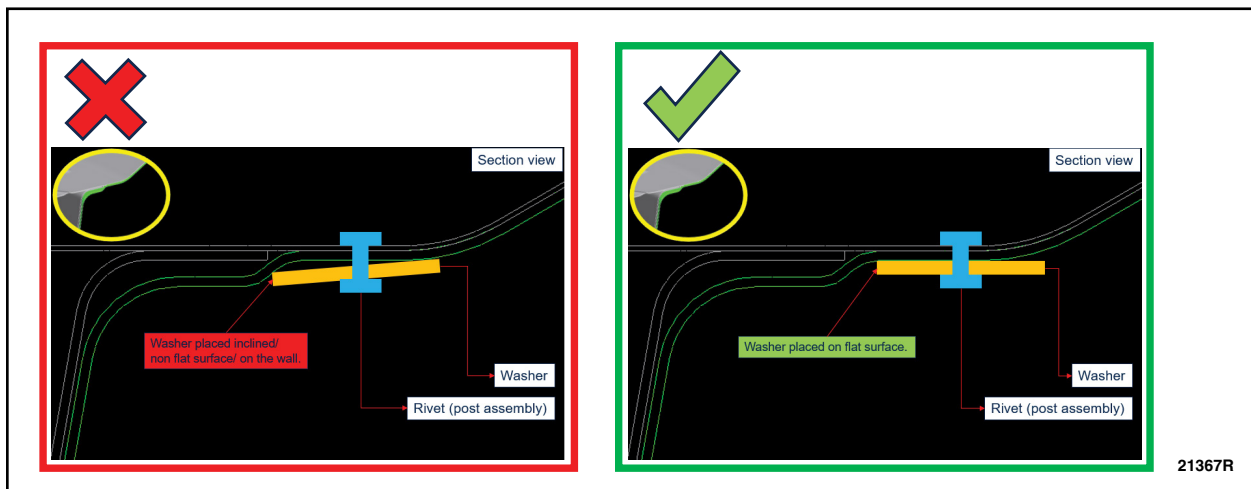

FIGURE 5



5. Using the 6.7mm (17/64 in) drill bit, drill a hole through the insulator and into the floor. See Figure 6.

NOTE: Use the 13mm (1/2 in) drill stop to ensure you do not drill through the carpet.



FIGURE 6

6. Repeat step 5 for the remaining four marked locations.

7. Using a small brush, apply a layer of the anti-corrosion coating to the edges of the newly drilled holes.

8. Install the washer onto the rivet. See Figure 7.



FIGURE 7



9. Apply a thick layer of seam sealer to the rivet, and the backside of the washer. See Figure 8.



FIGURE 8

10. Using a M18-1/4" rivet gun, install the rivet and washer to the drilled hole. See Figure 9.

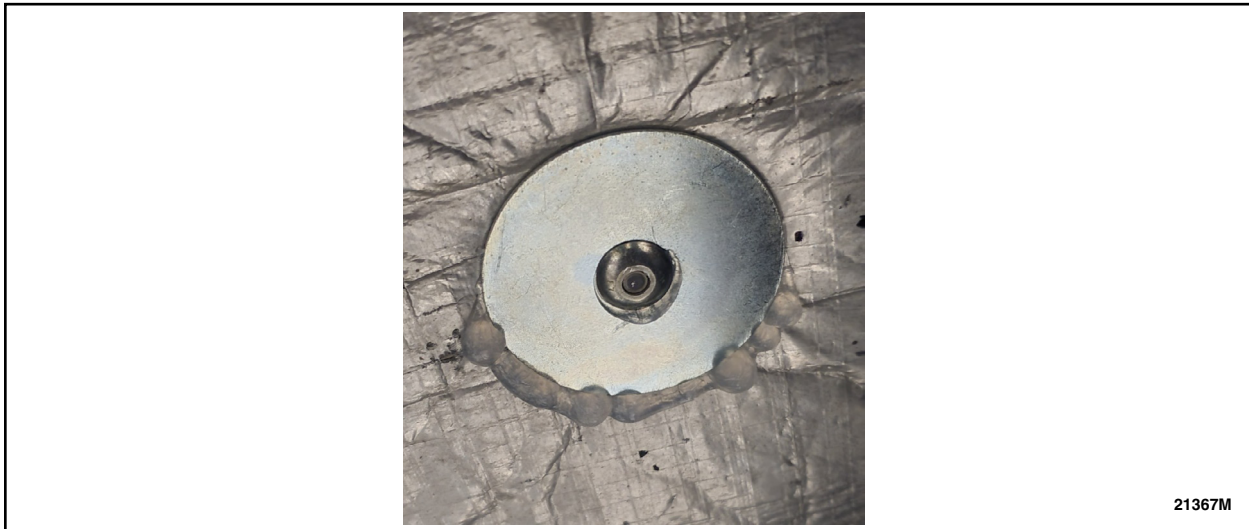

FIGURE 9

11. Using a small brush, apply a layer of the anti-corrosion coating to the washer and rivet.
12. Repeat steps 8-11 for the remaining four drilled holes.
13. Install the driveshaft. Please follow WSM procedures in Section 205-01.

NOTE: Both underbody insulators must be present to perform the above procedure.



Appendix A – Acceptable Photos



FIGURE 10



FIGURE 11



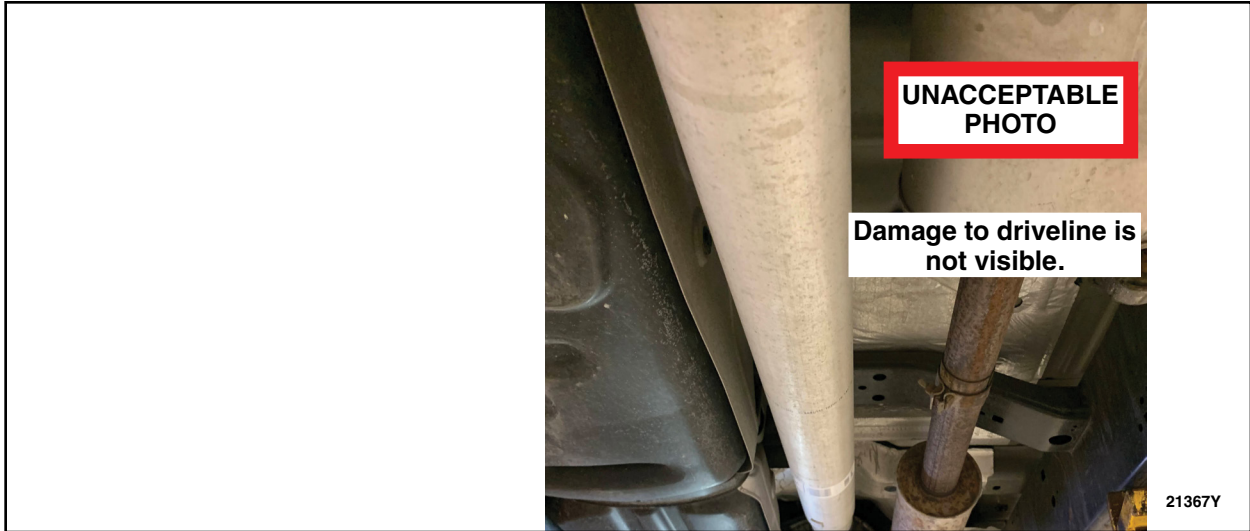

FIGURE 12



FIGURE 13



CERTAIN 2021-2022 MODEL YEAR F-150 VEHICLES EQUIPPED WITH A CREW CAB, 145" WHEELBASE, 4X4, 302A AND ABOVE OPTION PACKAGE, AND ONE-PIECE ALUMINUM DRIVESHAFT – LOOSE/SAGGING UNDERBODY INSULATORS

SERVICE PROCEDURE

HYBRID ENGINES

Table Of Contents

Inspection.....2

Driveshaft.....2

ECT Sensor Connectors.....3

Securing Underbody Insulators.....4

Appendix A - Acceptable Photos.....7

Materials List

Ruler/Scale	13 mm (1/2 in) Drill Stop	Small Brush	M18-1/4" Rivet Gun
Drill	6.7 mm (17/64 in) Drill Bit	Marker	

NOTE: The driver side insulator is located directly above the fuel tank.

NOTE: The passenger side insulator is located directly above the exhaust.

NOTE: Insulators are highlighted for illustration purposes only.

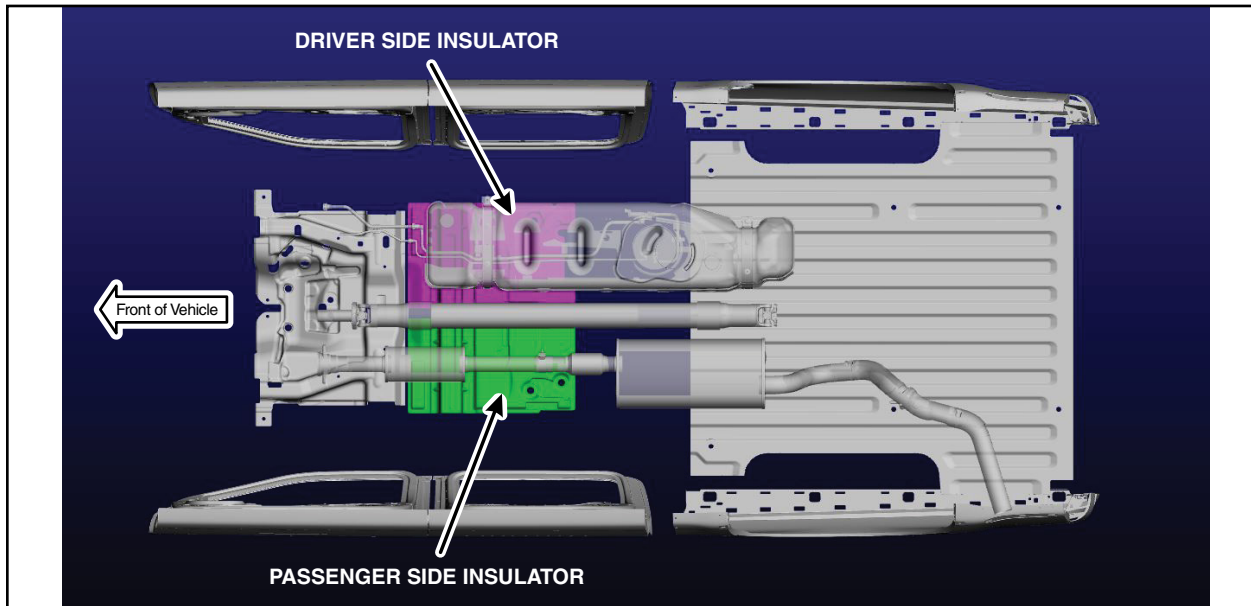

FIGURE 1



Inspection

1. With the vehicle in NEUTRAL, position it on a hoist. Please follow Workshop Manual (WSM) procedures in Section 100-02.
2. Remove the driveshaft. Please follow WSM procedures in Section 205-01.
3. Inspect the rear driveshaft for any marks caused by the passenger side insulator. Are there any marks present on the driveshaft due to contact from the insulator? See Figures 2 and 3.

Yes – Does not pass inspection. Contact the SSSC and provide a picture of the driveshaft with the marks. Once approved, rear driveshaft replacement will be required, but do not install at this time. Proceed to step 4.

No – Passes inspection. Proceed to step 4.

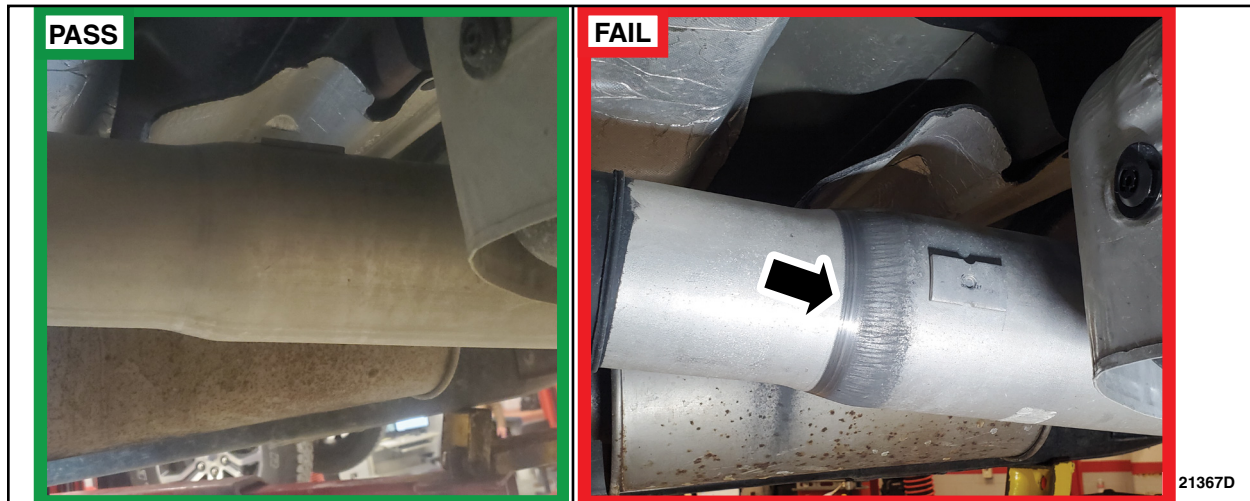

FIGURE 2



FIGURE 3



4. Inspect the front Engine Coolant Temperature (ECT) sensor connectors for any damage caused by the passenger side insulator. Is there any damage? See Figure 4.

Yes – Does not pass inspection. Contact the SSSC and provide a picture of the damage for proper technical instructions and part numbers, then proceed to step 5.

No – Proceed to step 5.

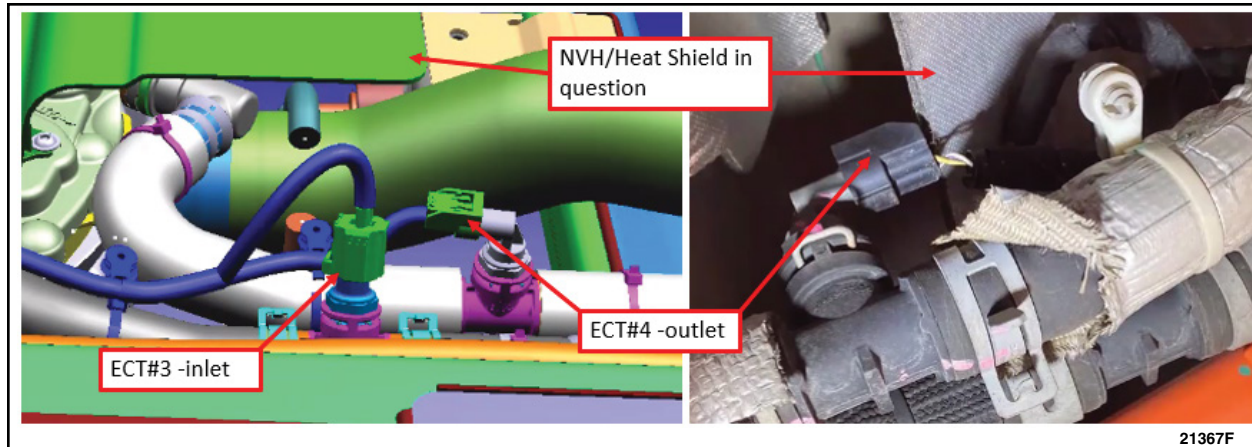
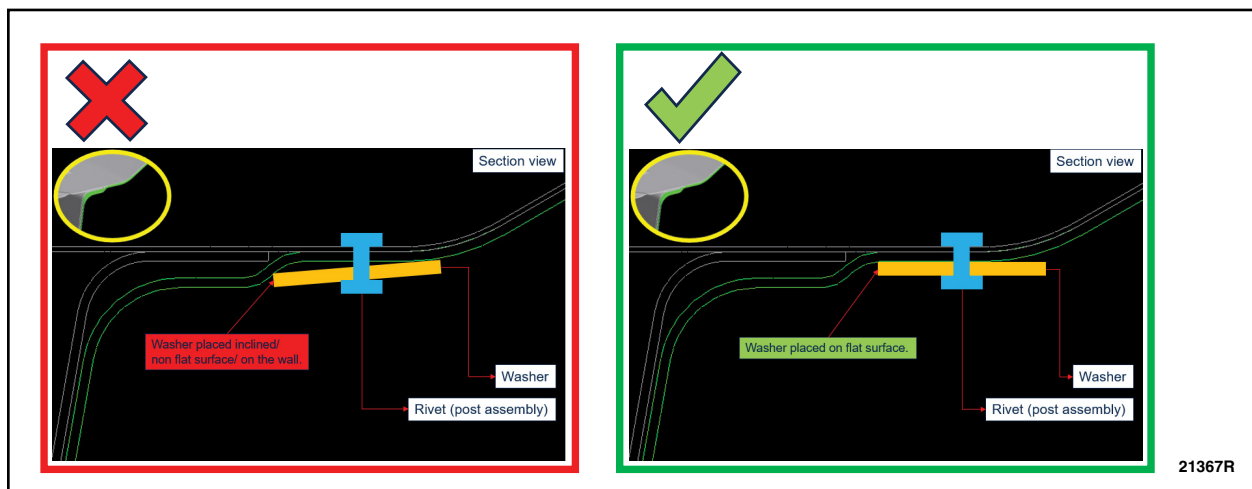
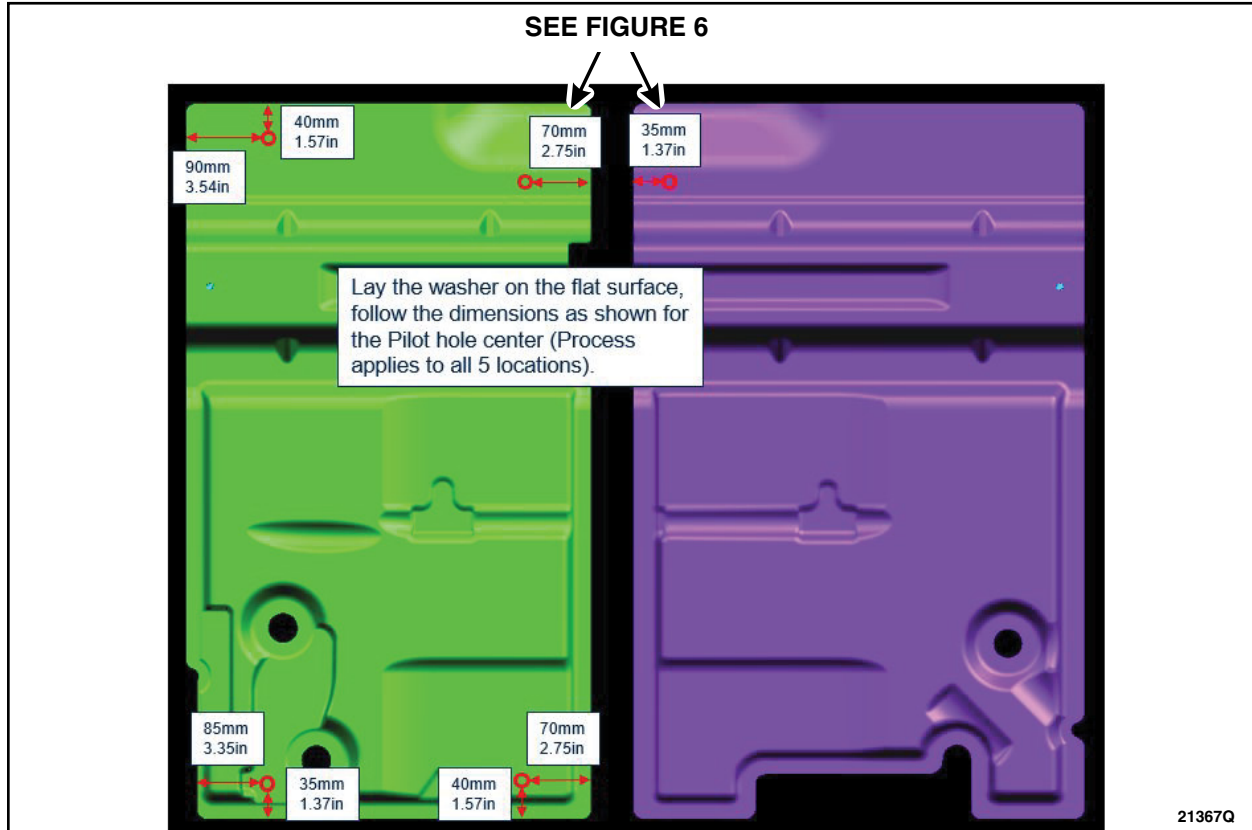

FIGURE 4



Securing Underbody Insulators

5. Measure and mark the four locations on the passenger side insulator and mark the one location on the driver side insulator. See Figures 5 and 6.



6. Using the 6.7mm (17/64 in) drill bit, drill a hole through the insulator and into the floor. See Figure 7.

NOTE: Use the 13mm (1/2 in) drill stop to ensure you do not drill through the carpet.

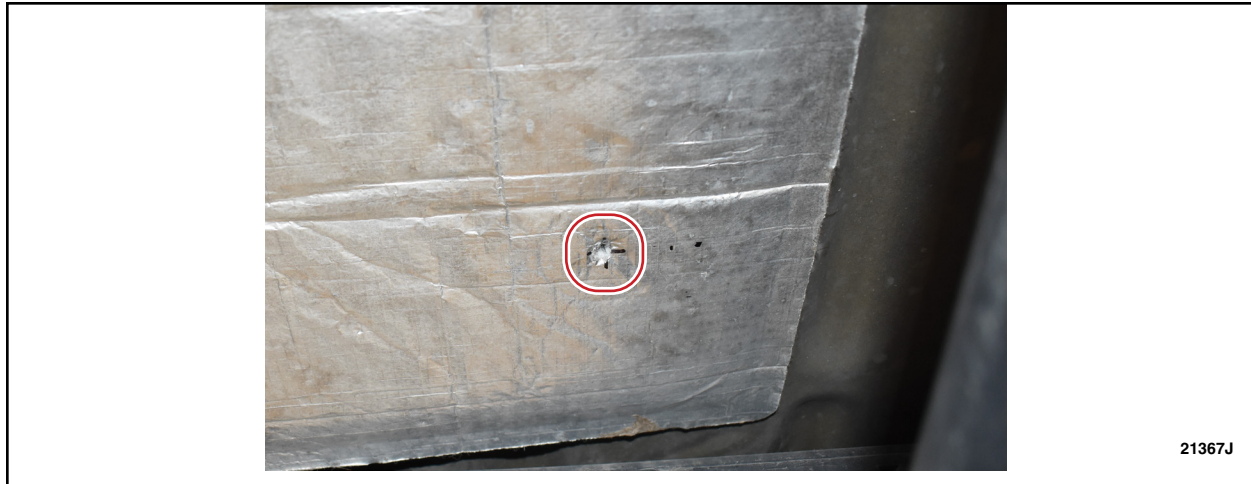

FIGURE 7

7. Repeat step 6 for the remaining four marked locations.

8. Using a small brush, apply a layer of the anti-corrosion coating to the edges of the newly drilled holes.

9. Install the washer onto the rivet. See Figure 8.



FIGURE 8



10. Apply a thick layer of seam sealer to the rivet, and the backside of the washer. See Figure 9.



FIGURE 9

11. Using a M18-1/4" rivet gun, install the rivet and washer to the drilled hole. See Figure 10.



FIGURE 10

12. Using a small brush, apply a layer of the anti-corrosion coating to the washer and rivet.

13. Repeat steps 9-12 for the remaining four drilled holes.

14. Install the driveshaft. Please follow WSM procedures in Section 205-01.

NOTE: Both underbody insulators must be present to perform the above procedure.



Appendix A – Acceptable Photos

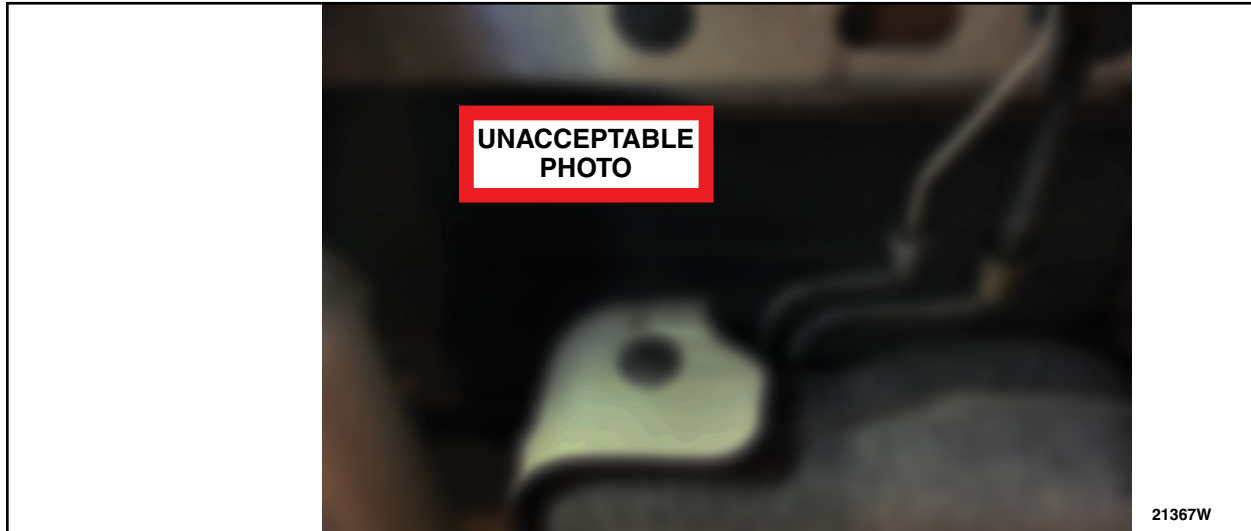

FIGURE 11



FIGURE 12





FIGURE 13



FIGURE 14



CERTAIN 2021-2022 MODEL YEAR F-150 VEHICLES EQUIPPED WITH A CREW CAB, 145" WHEELBASE, 4X4, 302A AND ABOVE OPTION PACKAGE, AND ONE-PIECE ALUMINUM DRIVESHAFT – LOOSE/SAGGING UNDERBODY INSULATORS

SERVICE PROCEDURE

GAS ENGINES – VEHICLES MANUFACTURED AT KANSAS CITY TRUCK ASSEMBLY PLANT

Table Of Contents

Check for DTCs.....2

Inspection.....3

Driveshaft.....3

Securing Underbody Insulators.....4

Appendix A - Acceptable Photos.....7

Materials List

Ruler/Scale	13 mm (1/2 in) Drill Stop	Small Brush	M18-1/4" Rivet Gun
Drill	6.7 mm (17/64 in) Drill Bit	Marker	



NOTE: The driver side insulator is located directly above the fuel tank.

NOTE: The passenger side insulator is located directly above the exhaust.

NOTE: Insulators are highlighted for illustration purposes only.

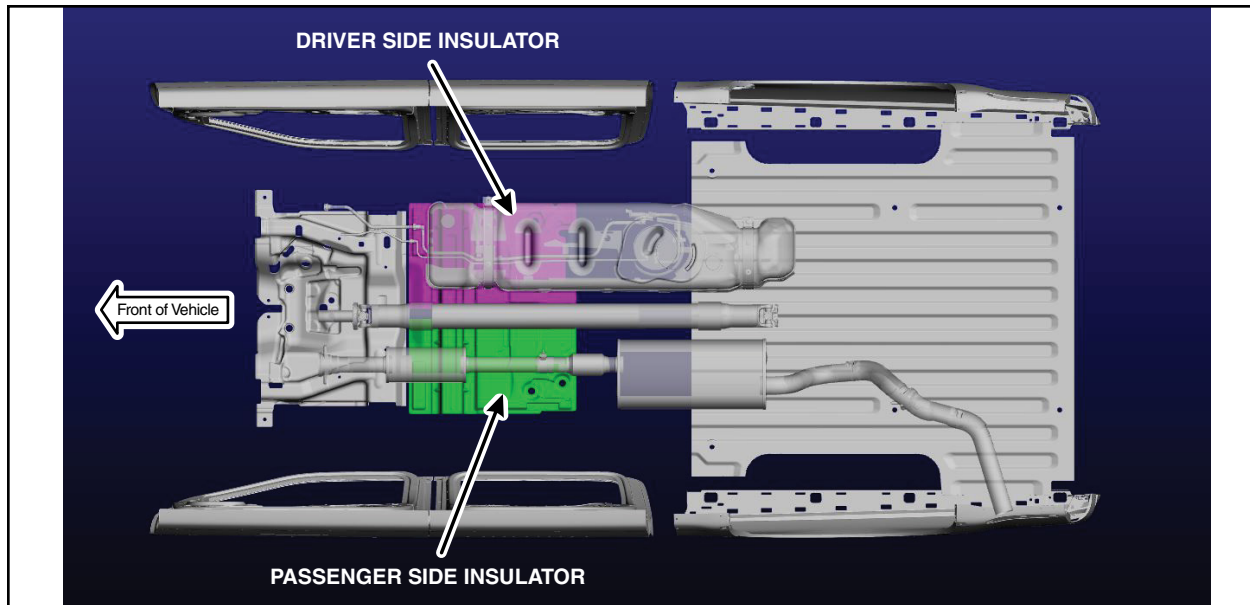

FIGURE 1

Check for DTCs

1. Using the Ford Diagnostic and Repair System (FDRS), check the Powertrain Control Module (PCM) for DTCs. Are either of the following DTC's present in the PCM, P0442 and/or P0456?

Yes - Please follow Workshop Manual (WSM) procedures for pinpoint test HX in Section 303-13, then proceed to step 2.

No - Proceed to step 2.



Inspection

2. With the vehicle in NEUTRAL, position it on a hoist. Please follow Workshop Manual (WSM) procedures in Section 100-02.
3. Remove the driveshaft. Please follow WSM procedures in Section 205-01.
4. Inspect the rear driveshaft for any marks caused by the passenger side insulator. Are there any marks present on the driveshaft due to contact from the insulator? See Figures 2 and 3.

Yes – Does not pass inspection. Contact the SSSC and provide a picture of the driveshaft with the marks. Once approved, rear driveshaft replacement will be required, but do not install at this time. Proceed to step 5.

No – Passes inspection. Proceed to step 5.

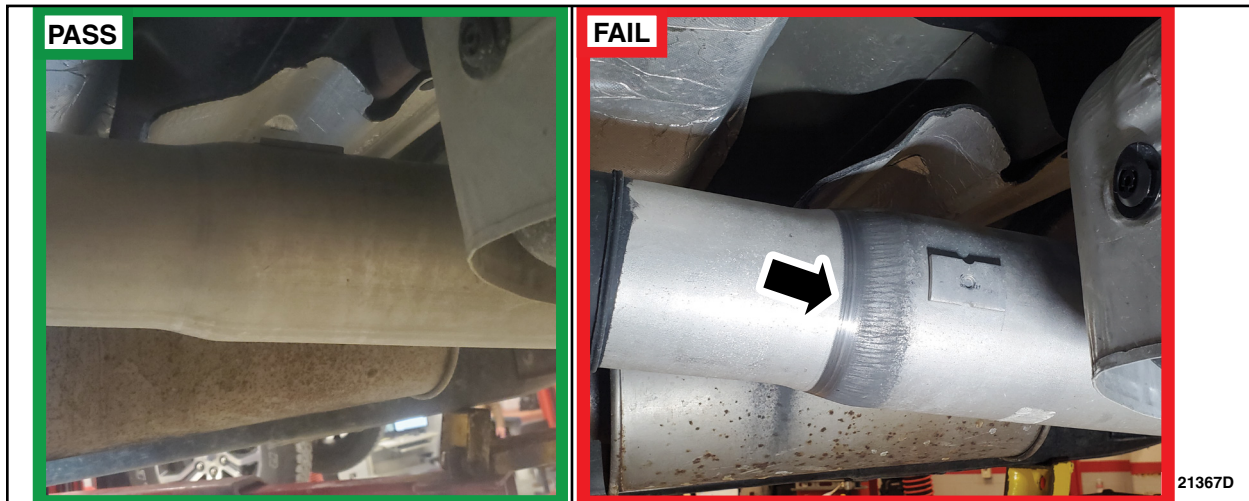

FIGURE 2



FIGURE 3



Securing Underbody Insulators

5. Measure and mark the two locations on the passenger side insulator. See Figure 4.



FIGURE 4

6. Using the 6.7mm (17/64 in) drill bit, drill a hole through the insulator and into the floor. See Figure 5.

NOTE: Use the 13mm (1/2 in) drill stop to ensure you do not drill through the carpet.

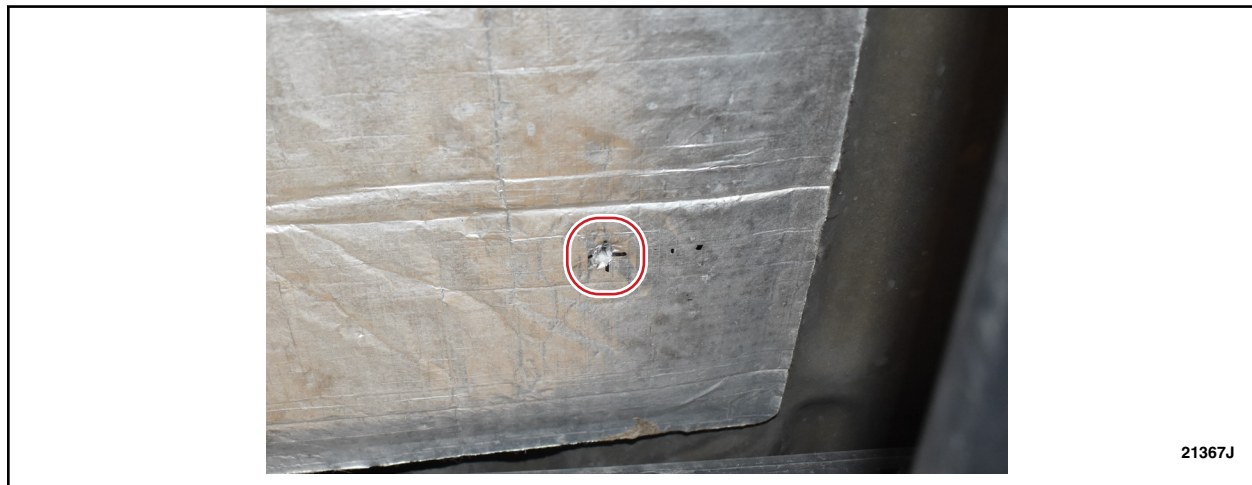

FIGURE 5



7. Repeat step 6 for the second marked location.
8. Using a small brush, apply a layer of the anti-corrosion coating to the edges of the newly drilled holes.
9. Install the washer onto the rivet. See Figure 6.



FIGURE 6

10. Apply a thick layer of seam sealer to the rivet, and the backside of the washer. See Figure 7.



FIGURE 7



11. Using a M18-1/4" rivet gun, install the rivet and washer to the drilled hole. See Figure 8.



FIGURE 8

12. Using a small brush, apply a layer of the anti-corrosion coating to the washer and rivet.

13. Repeat steps 9-12 for the second drilled hole.

14. Install the driveshaft. Please follow WSM procedures in Section 205-01.

NOTE: Both underbody insulators must be present to perform the above procedure.



Appendix A – Acceptable Photos

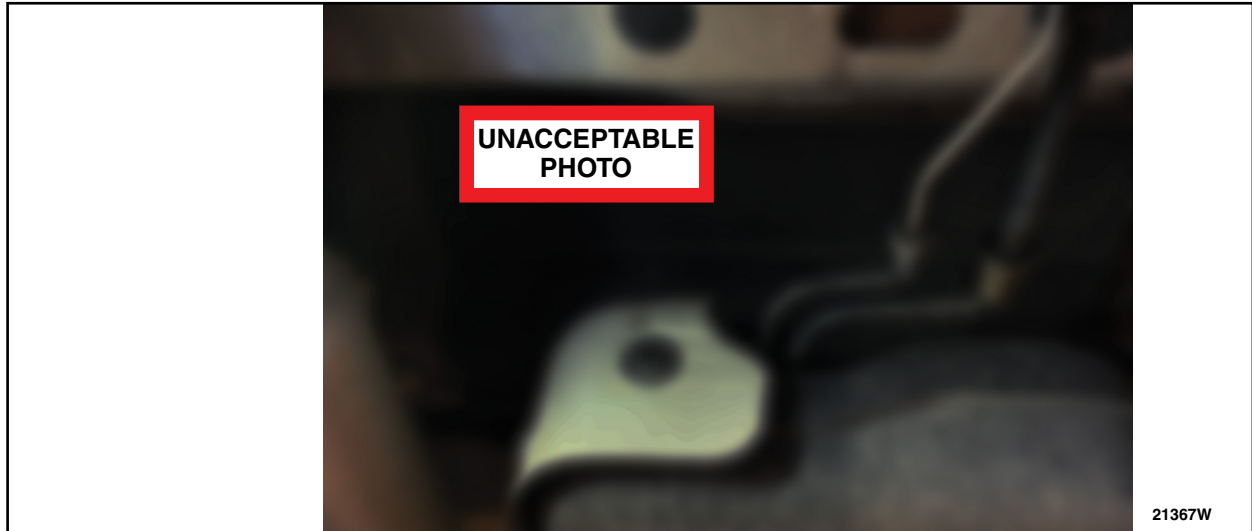

FIGURE 9



FIGURE 10



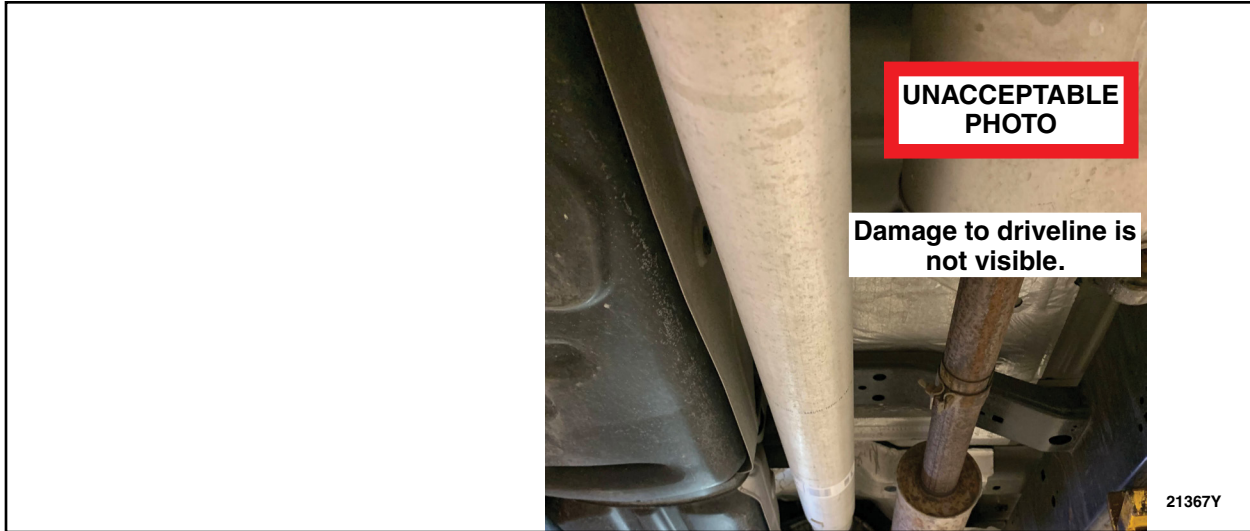

FIGURE 11



FIGURE 12

