



David J. Johnson
 Director
 Service Engineering Operations
 Ford Customer Service Division

Ford Motor Company
 P. O. Box 1904
 Dearborn, Michigan 48121

March 11, 2022

TO: All U.S. Ford and Lincoln Dealers

SUBJECT: **NEW VEHICLE DEMONSTRATION / DELIVERY HOLD**
Compliance Recall 21C24 Supplement # 3
 Certain 2020-2021 Model Year Ranger Super Cab Vehicles
 Rear Seat Child Restraint Anchorage System

REF: **NEW VEHICLE DEMONSTRATION / DELIVERY HOLD**
Compliance Recall 21C24 S# 2
 Certain 2020-2021 Model Year Ranger Super Cab Vehicles
 Rear Seat Child Restraint Anchors

New! REASON FOR THIS SUPPLEMENT

Rear Head Restraints are no longer on restricted order.

AFFECTED VEHICLES

Vehicle	Model Year	Assembly Plant	Build Dates
Ranger Super Cab	2020-2021	Michigan Assy Plant	July 16, 2019 through September 20, 2021

Affected vehicles are identified in OASIS and FSA VIN Lists.

REASON FOR THIS COMPLIANCE RECALL

Some of the affected vehicles may not conform to the requirements specified by Federal Motor Vehicle Safety Standard (FMVSS) No. 225. Child Restraint Anchorage Systems. On affected vehicles, the rear seat head restraints may interfere with proper installation of certain taller child seats. Additionally, the lower rear child seat anchorages may be improperly aligned which may increase the difficulty of installing a child seat with rigid anchor attachments.

SERVICE ACTION

Before demonstrating or delivering any new in-stock vehicles involved in this recall, dealers are to replace the left and right rear head restraints and perform an inspection of the rear seat child restraint anchorages for straightness and adjust if needed with provided instructions.

This service must be performed on all affected vehicles at no charge to the vehicle owner.

OWNER NOTIFICATION MAILING SCHEDULE

Owner letters were mailed the week of March 7, 2022. Dealers should repair any affected vehicles that arrive at their dealerships, whether or not the customer has received a letter.

PLEASE NOTE:

Federal law requires dealers to complete this recall service before a new vehicle is delivered to the buyer or lessee. Violation of this requirement by a dealer could result in a civil penalty of up to \$21,000 per vehicle. Correct all vehicles in your new vehicle inventory before delivery.

ATTACHMENTS

Attachment I: Administrative Information
Attachment II: Labor Allowances and *Parts Ordering Information*
Attachment III: Technical Information

QUESTIONS & ASSISTANCE

For questions and assistance, contact the Special Service Support Center (SSSC) via the SSSC Web Contact Site. The SSSC Web Contact Site can be accessed through the Professional Technician System (PTS) website using the SSSC link listed at the bottom of the OASIS VIN report screen or listed under the SSSC tab.

Sincerely,



David J. Johnson

NEW VEHICLE DEMONSTRATION / DELIVERY HOLD
Compliance Recall 21C24 Supplement # 3
Certain 2020-2021 Model Year Ranger Super Cab Vehicles
Rear Seat Child Restraint Anchorage System

OASIS ACTIVATION

OASIS was activated on October 1, 2021

FSA VIN LISTS ACTIVATION

FSA VIN Lists was made available through <https://web.fsavinlists.dealerconnection.com> on October 1, 2021. Owner names and addresses will be available the week of March 21, 2022.

NOTE: Your FSA VIN Lists may contain owner names and addresses obtained from motor vehicle registration records. The use of such motor vehicle registration data for any purpose other than in connection with this recall is a violation of law in several states, provinces, and countries. Accordingly, you must limit the use of this listing to the follow-up necessary to complete this recall.

SOLD VEHICLES

Owners can continue to safely drive their vehicles. If a child seat is not properly installed, it can increase the risk of injury in a crash.

- Immediately contact any of your affected customers whose vehicles are not on your VIN list but are identified in OASIS. Give the customer a copy of the Owner Notification Letter (when available) and schedule a service date.
- Correct other affected vehicles identified in OASIS which are brought to your dealership.
- Dealers are to prioritize repairs of customer vehicles over repairs of new and used vehicle inventory.

STOCK VEHICLES

- Correct all affected units in your new vehicle inventory before delivery.
- Use OASIS to identify any affected vehicles in your used vehicle inventory.

DEALER-OPERATED RENTAL VEHICLES

The Fixing America's Surface Transportation (FAST) Act law effective June 2016 prohibits a rental company from selling, renting or leasing vehicles subject to a safety or compliance recall. Please consult your legal counsel for legal advice.

TITLE BRANDED / SALVAGED VEHICLES

Affected title branded and salvaged vehicles are eligible for this recall.

NEW VEHICLE DEMONSTRATION / DELIVERY HOLD
Compliance Recall 21C24 Supplement # 3
Certain 2020-2021 Model Year Ranger Super Cab Vehicles
Rear Seat Child Restraint Anchorage System

OWNER REFUNDS

Refunds are not approved for this program.

RENTAL VEHICLES

Rental vehicles are not approved for this program.

ADDITIONAL REPAIR (LABOR TIME AND/OR PARTS)

Additional repairs identified as necessary to complete the FSA should be managed as follows:

- For related damage and access time requirements, refer to the Warranty and Policy Manual / Section 6 – Ford & Lincoln Program Policies / General Information & Special Circumstances for FSA's / Related Damage.
- For vehicles within new vehicle bumper-to-bumper warranty coverage, no SSSC approval is required, although related damage must be on a separate repair line with the "Related Damage" radio button checked.
 - Ford vehicles – 3 years or 36,000 miles
- For vehicles outside new vehicle bumper-to-bumper warranty coverage, submit an Approval Request to the SSSC Web Contact Site prior to completing the repair.

CLAIMS PREPARATION AND SUBMISSION

- **Claim Entry:** Enter claims using Dealer Management System (DMS) or One Warranty Solution (OWS) online.
 - When entering claims, select claim type 31: Field Service Action. The FSA number 21C24 is the sub code.
 - For additional claims preparation and submission information, refer to the Recall and Customer Satisfaction Program (CSP) Repairs in the OWS User Guide.
- **Related Damage/Additional labor and/or parts:** Must be claimed as Related Damage on a separate repair line from the FSA with same claim type and sub code as described in Claim Entry above.

IMPORTANT: Click the Related Damage Indicator radio button.

- **Provision for quarter inch aluminum U-channel:** ¼" wide X 14" long U-Channel

NOTE: This is a one-time charge per dealer as tool can be used on multiple vehicles. Do not charge this amount more than once.

- Program Code: 21C24
- Misc. Expense: OTHER
- Amount: Up to \$10.00

NEW VEHICLE DEMONSTRATION / DELIVERY HOLD
Compliance Recall 21C24 Supplement # 3
 Certain 2020-2021 Model Year Ranger Super Cab Vehicles
 Rear Seat Child Restraint Anchorage System

LABOR ALLOWANCES

Description	Labor Operation	Labor Time
Inspection: Both Rear Seat Anchors Pass <ul style="list-style-type: none"> FSA stays open until head restraints are available. 	21C24AA	0.3 Hours
Inspection: Inspect Both Rear Seat Anchors, One seat fails, remove one seat back / Adjust Rear Child Anchors <ul style="list-style-type: none"> FSA stays open until head restraints are available. 	21C24BB	0.3 Hours
Inspection: Inspect Both Rear Seat Anchors, Both seats fail, remove both seat backs / Adjust Rear Child Anchors <ul style="list-style-type: none"> FSA stays open until head restraints are available. 	21C24CC	0.4 Hours

Note: The above Labor operations can only be claimed on RO's open on or prior to February 22, 2022. These labor operations will expire July 1, 2022.

LABOR ALLOWANCES

Description	Labor Operation	Labor Time
Inspection: Both Rear Seat Anchors Pass <ul style="list-style-type: none"> Replace Both Rear Head Restraints. 	21C24B	0.3 Hours
Inspection: Rear Seat Removal: One seat fails / Adjust Rear Child Anchors <ul style="list-style-type: none"> Replace Both Rear Head Restraints. 	21C24C	0.4 Hours
Inspection: Rear Seat Removal: Both seats fail / Adjust Rear Child Anchors <ul style="list-style-type: none"> Replace Both Rear Head Restraints. 	21C24D	0.4 Hours

Only one labor operation can be claimed per repair.

NEW VEHICLE DEMONSTRATION / DELIVERY HOLD
Compliance Recall 21C24 Supplement # 3
Certain 2020-2021 Model Year Ranger Super Cab Vehicles
Rear Seat Child Restraint Anchorage System

NEW!

PARTS REQUIREMENTS / ORDERING INFORMATION

Order the parts below through normal order processing channels:

Part Number	Description	Order Quantity	Claim Quantity
Obtain Locally	¼"-inch Wide X 14"-inch Long Aluminum U-Channel	Claim as MISC other up to \$10.00	
MB3Z-21611A08-AB	Rear Head Restraint Vinyl Ebony	2	2
MB3Z-21611A08-CC	Rear Head Restraint Cloth Ebony	2	2
MB3Z-21611A08-DC	Rear Head Restraint Salerno Ebony	2	2
MB3Z-21611A08-DD	Rear Head Restraint Salerno Medium Stone	2	2
MB3Z-21611A08-CD	Rear Head Restraint Cloth Medium Stone	2	2
MB3Z-21611A08-BB	Rear Head Restraint Ash Black	2	2

DEALER PRICE

For latest prices, refer to DOES II.

PARTS RETENTION, RETURN, & SCRAPPING

Follow the provisions of the Warranty and Policy Manual, Section 1 - WARRANTY PARTS RETENTION AND RETURN POLICIES. If a replaced part receives a scrap disposition, the part must be scrapped in accordance with all applicable local, state and federal environmental protection and hazardous material regulations. Federal law prohibits selling motor vehicle parts or components that are under safety, compliance, or emissions recall.

NEW VEHICLE DEMONSTRATION / DELIVERY HOLD
Compliance Recall 21C24 Supplement # 3
Certain 2020-2021 Model Year Ranger Super Cab Vehicles
Rear Seat Child Restraint Anchorage System

EXCESS STOCK RETURN

Excess stock returned for credit must have been purchased from Ford Customer Service Division in accordance with Policy Procedure Bulletin 4000.

REPLACED FSA PARTS INSPECTION AND SIGN OFF

Effective March 1st, 2021 all parts replaced as part of an FSA repair with a repair order open date of March 1st, 2021 or later must be inspected and signed off on the repair order by a member of your dealers fixed operations management team or an employee the task has been delegated to. If the task is to be delegated to a non-management employee, the employee needs to be someone other than the technician who completed the repair and needs to understand the importance of completing this task consistently and accurately.

- All parts replaced as part of an FSA repair should be returned to the parts department following the Warranty Parts Retention and Return Policies.
- Inspect the replaced parts to verify the FSA repair was completed.
- If the FSA repair is found to be complete, the designated employee signs the repair order line or parts return stamp area (electronic or hand signed) for the FSA repair indicating the parts were inspected and validated to have been replaced.
- After the parts have been inspected, they should be handled based on the guidance in the parts status report in the Online Warranty System (Hold, Return, CORE, Scrap, etc.).
- This process is subject to review during warranty audits for FSA repairs with a repair order open date of March 1st, 2021 or later. Any eligible FSA claims requiring parts replacement, found not to have been inspected and signed off during a warranty audit will be subject to chargeback and consideration for enrollment into the Dealer Incomplete Recall Repair Process.

Note: Other approvals (electronic or handwritten) for add-on repair lines, dealer owned vehicle repairs, and repeat repairs do not qualify as FSA parts inspection approvals. The post repair FSA parts inspection process (electronic or handwritten) is independent from other warranty approval requirements. The approval by the designated employee implies that the FSA parts were found to be replaced and must be able to be clearly identified on the Repair Order. If multiple FSA's require approval on a single Repair Order, each applicable occurrence will require individual post repair approval by the designated employee.

CERTAIN 2021 MODEL YEAR RANGER SUPER CAB VEHICLES — CHILD RESTRAINT ANCHOR

SERVICE PROCEDURE

1. Locally obtain a section of 1/4 inch (6.35 mm) aluminum trim channel and cut to 14 inches (355.5 mm) in length. The Aluminum trim channel can be found at your local hardware store in the "Metal Pieces and Welding Supplies" aisle. See Figure 1.

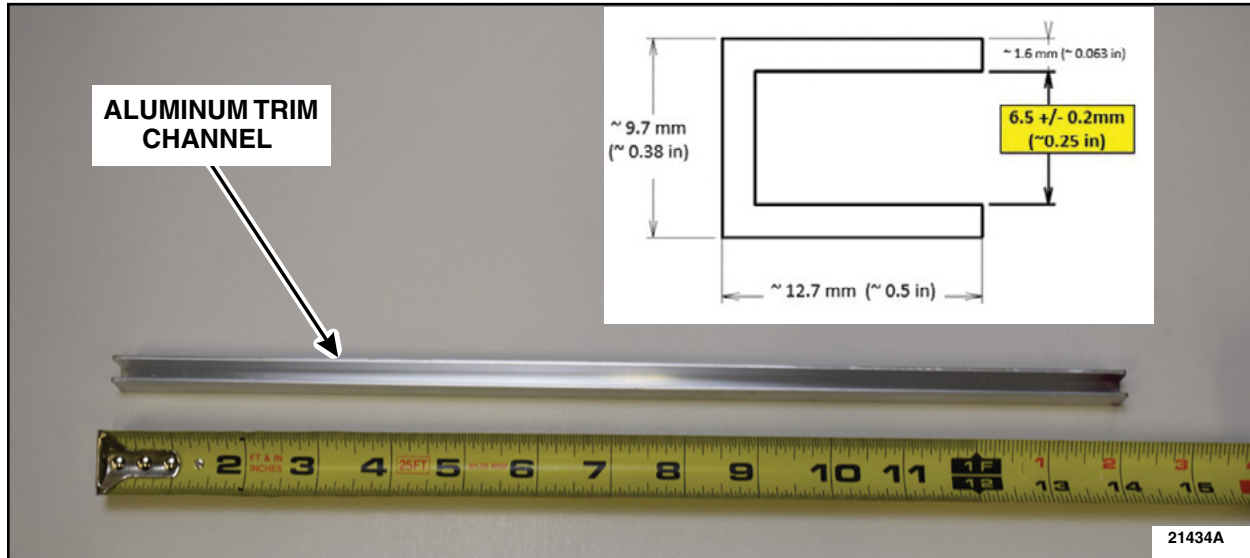

FIGURE 1

2. Remove both the Right Hand (RH) and the Left Hand (LH) rear seat cushions. Please follow the Workshop Manual (WSM) procedures in Section 501-10B.



3. On both sides, position the rear seat backrest bolt cover upward. See Figure 2.

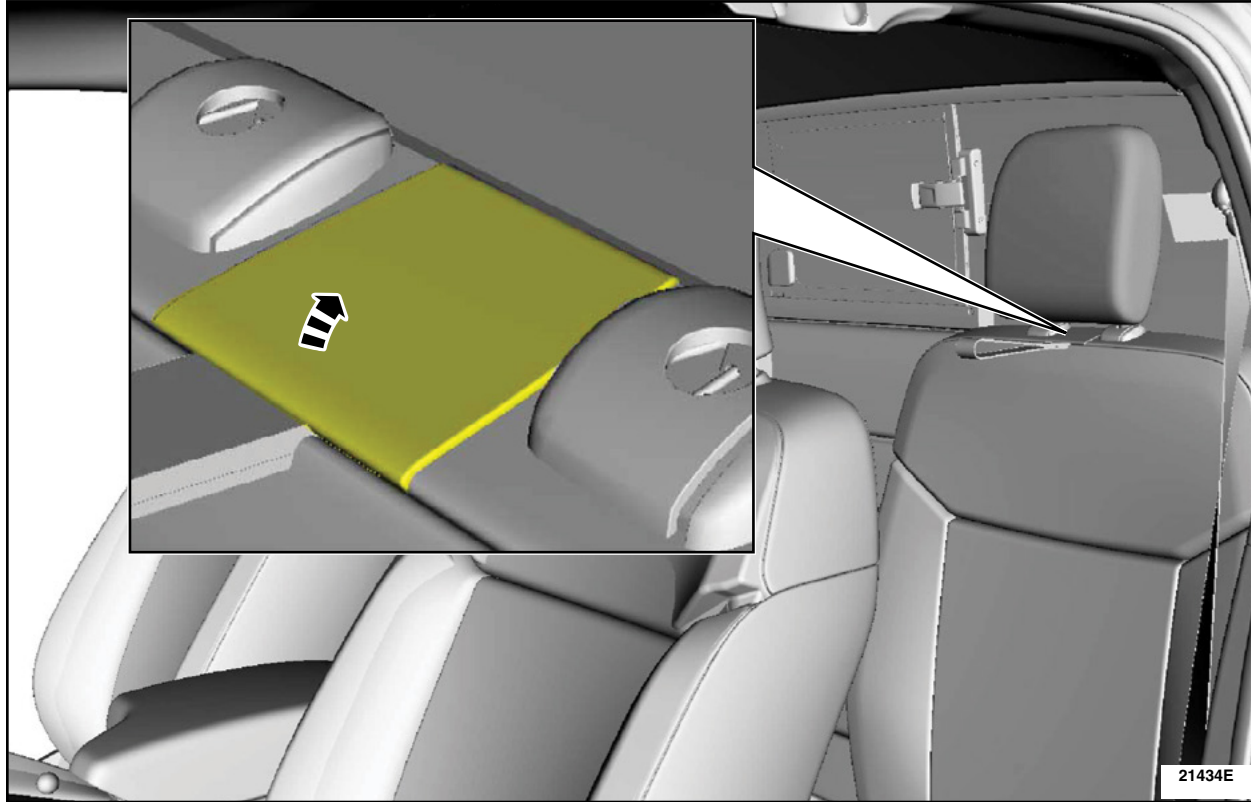

FIGURE 2



4. On both sides, remove the rear seat backrest bolts. See Figure 3.



FIGURE 3

5. On both sides, release the clip and remove the rear seat backrest. See Figure 4.

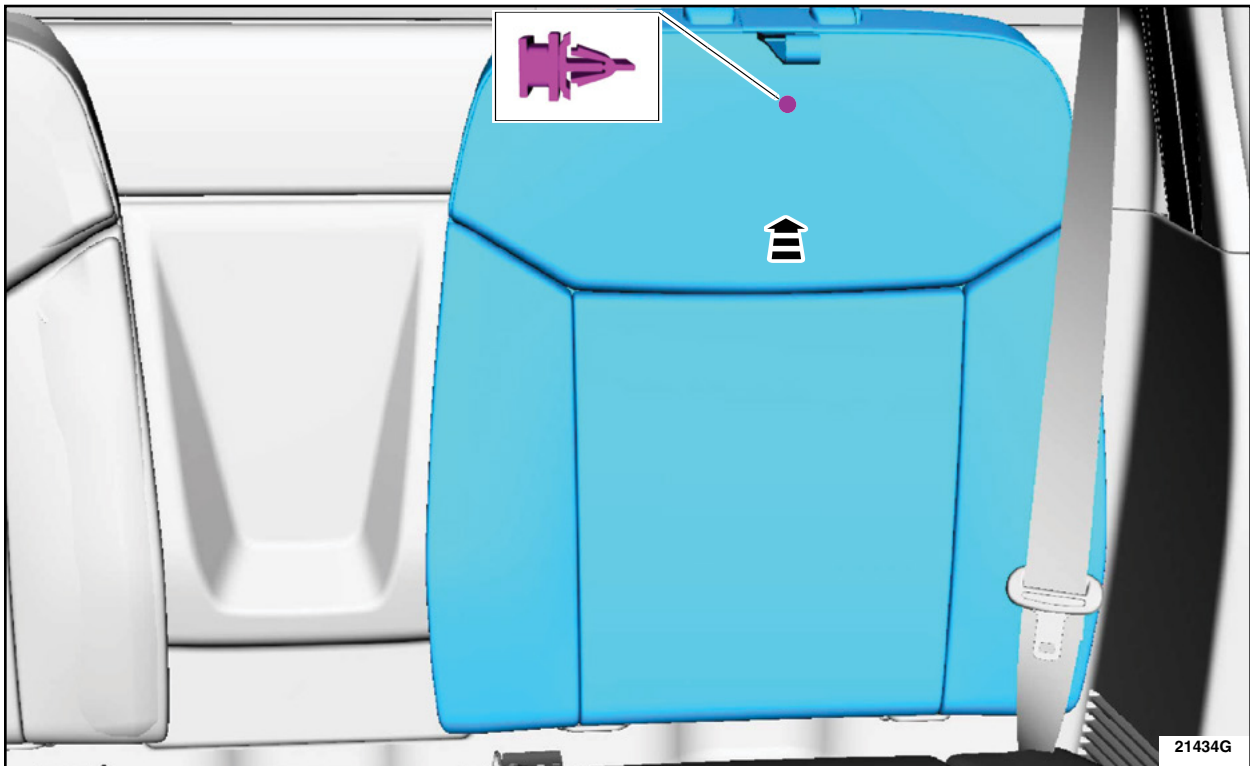

FIGURE 4



6. On both sides of the vehicle, place the 1/4 inch (6.35 mm) aluminum trim channel over the child restraint anchors. If the aluminum trim channel fits over both of the child restraint anchors that side of the vehicle is considered a pass. See Figure 5. Did either rear RH or LH child restraint anchors fail?

Yes - Proceed to Step 7.

No - Proceed to Step 9.

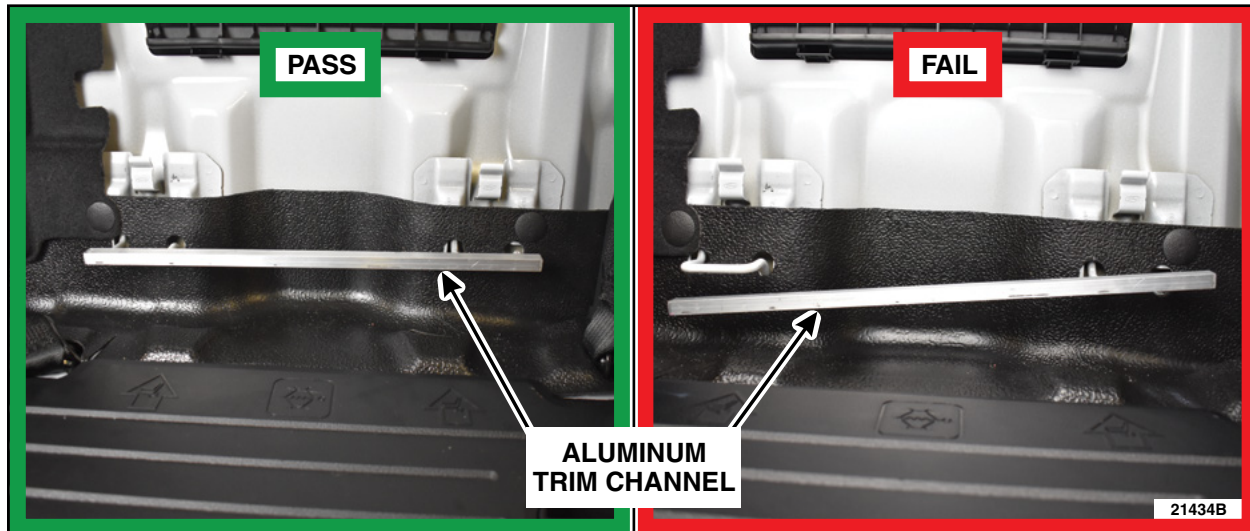

FIGURE 5

7. Cover a 12 inch (305 mm) pry bar with a clean shop rag and adjust the affected child restraint anchor(s) in a clockwise rotation. See Figure 6.



FIGURE 6



8. Place the 1/4 inch (6.35 mm) aluminum trim channel over the adjusted child restraint anchor(s). Does the affected child restraint anchor(s) fit within the aluminum trim channel? See Figure 7.

Yes - Proceed to Step 9.
No - Proceed to Step 7.

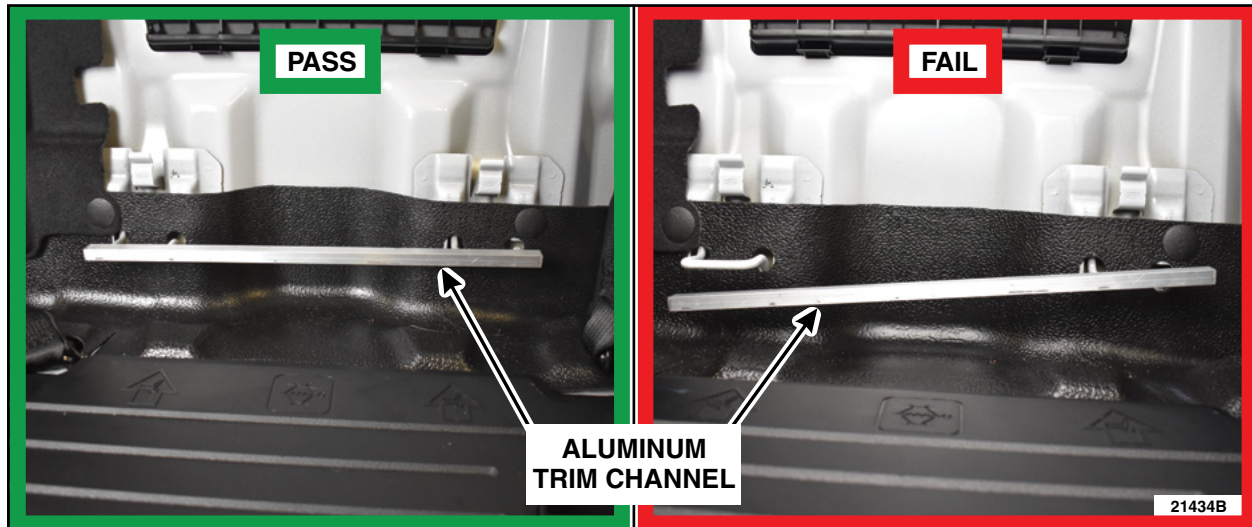

FIGURE 7

9. Press inward on the head restraint locks, then remove and discard both rear headrests. See Figure 8.

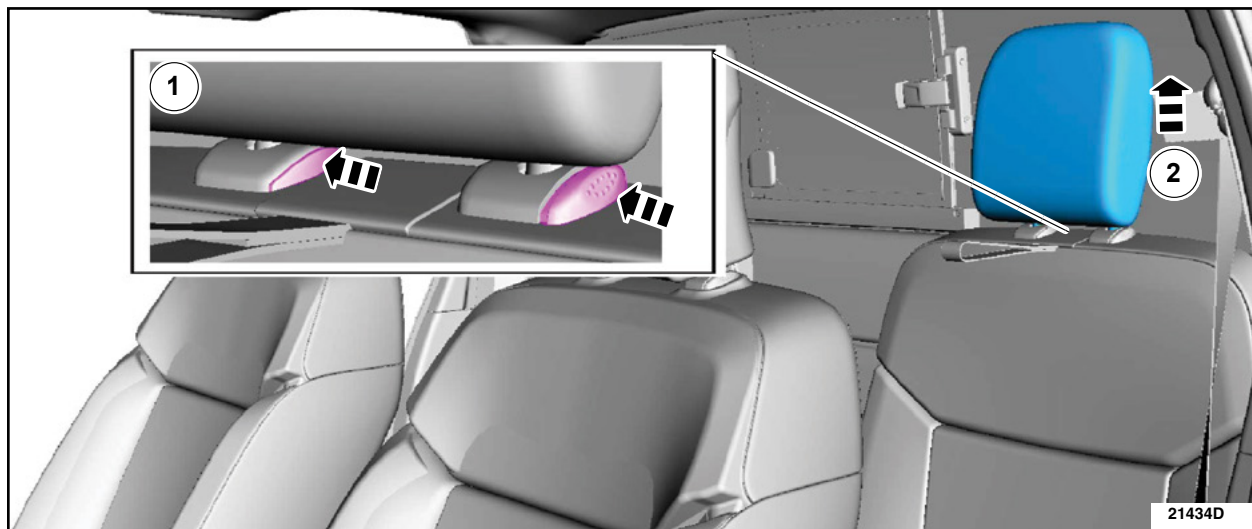

FIGURE 8



10. Install the new headrest by reversing the removal procedure See Figure 8.

NOTE: Do not install a *new* retaining clip to the seat back.

11. On both sides, install the rear seat backrests. See Figure 9.

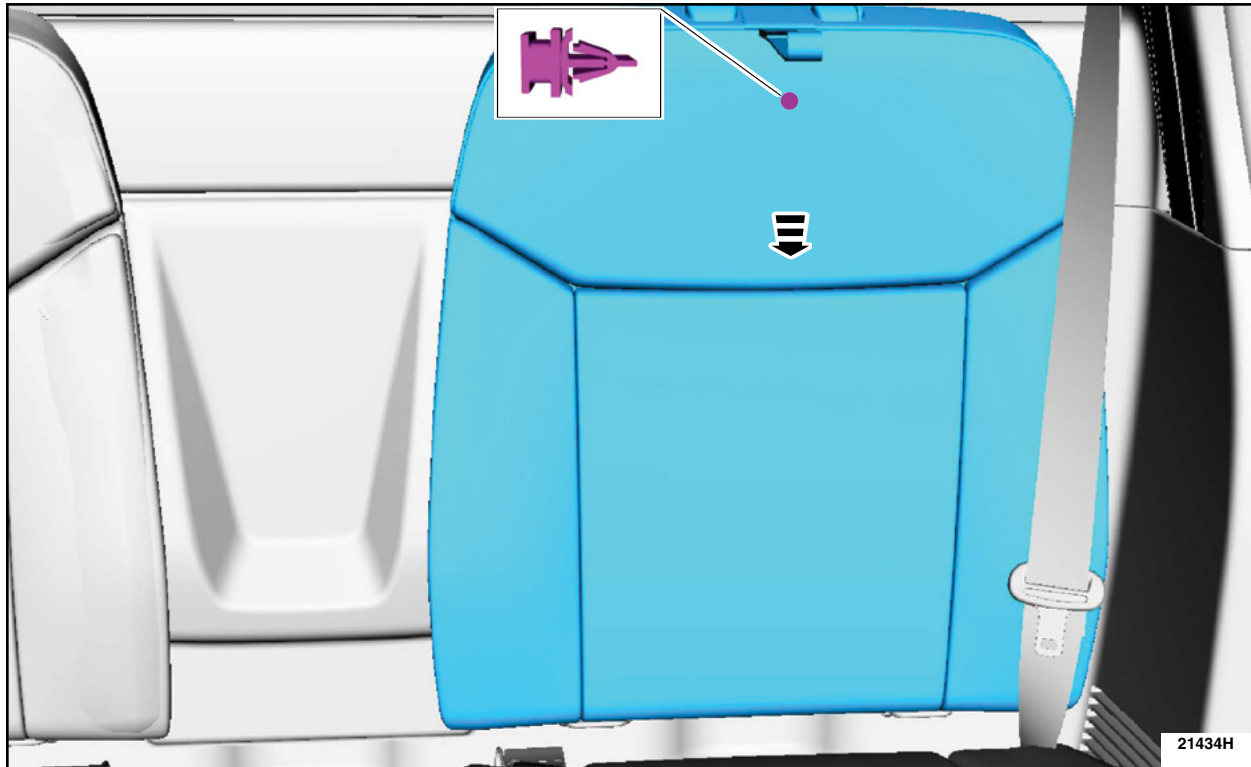

FIGURE 9



12. On both sides, install the rear seat backrest bolts. See Figure 10.

- Torque: 35 lb.ft (48 Nm)

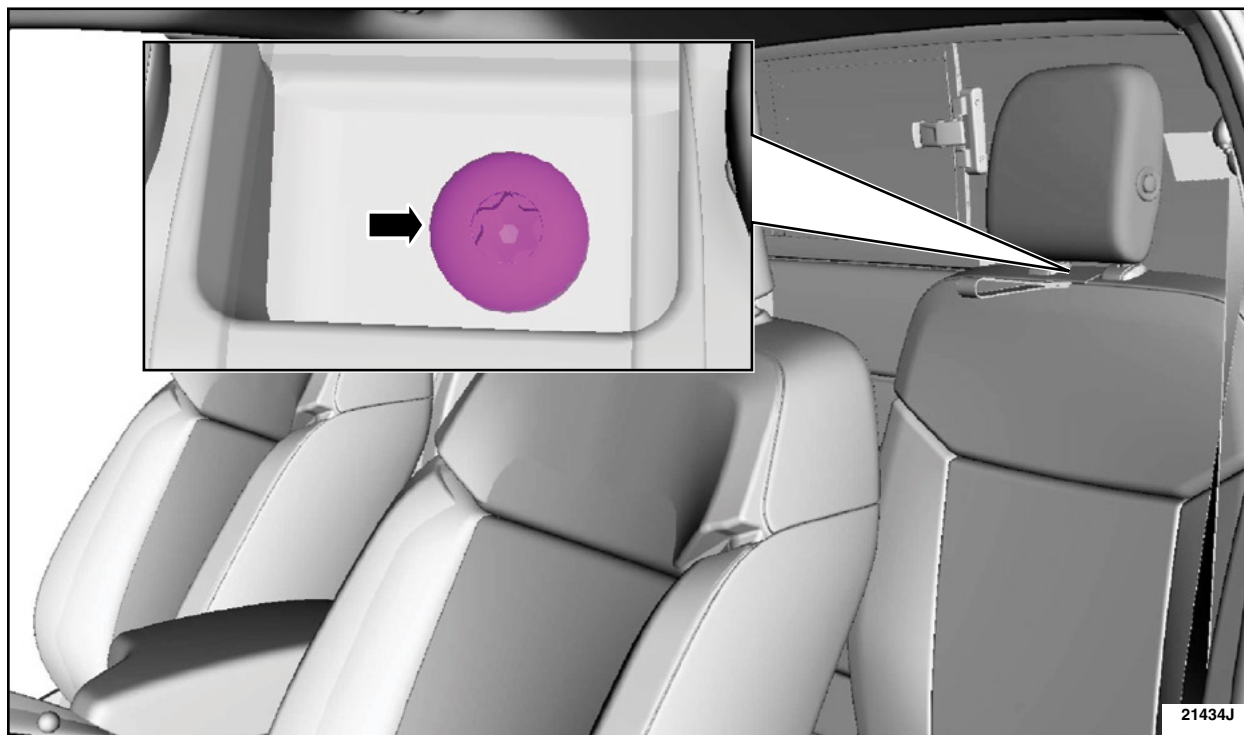

FIGURE 10



13. On both sides, position back the rear seat backrest bolt covers. See Figure 11.

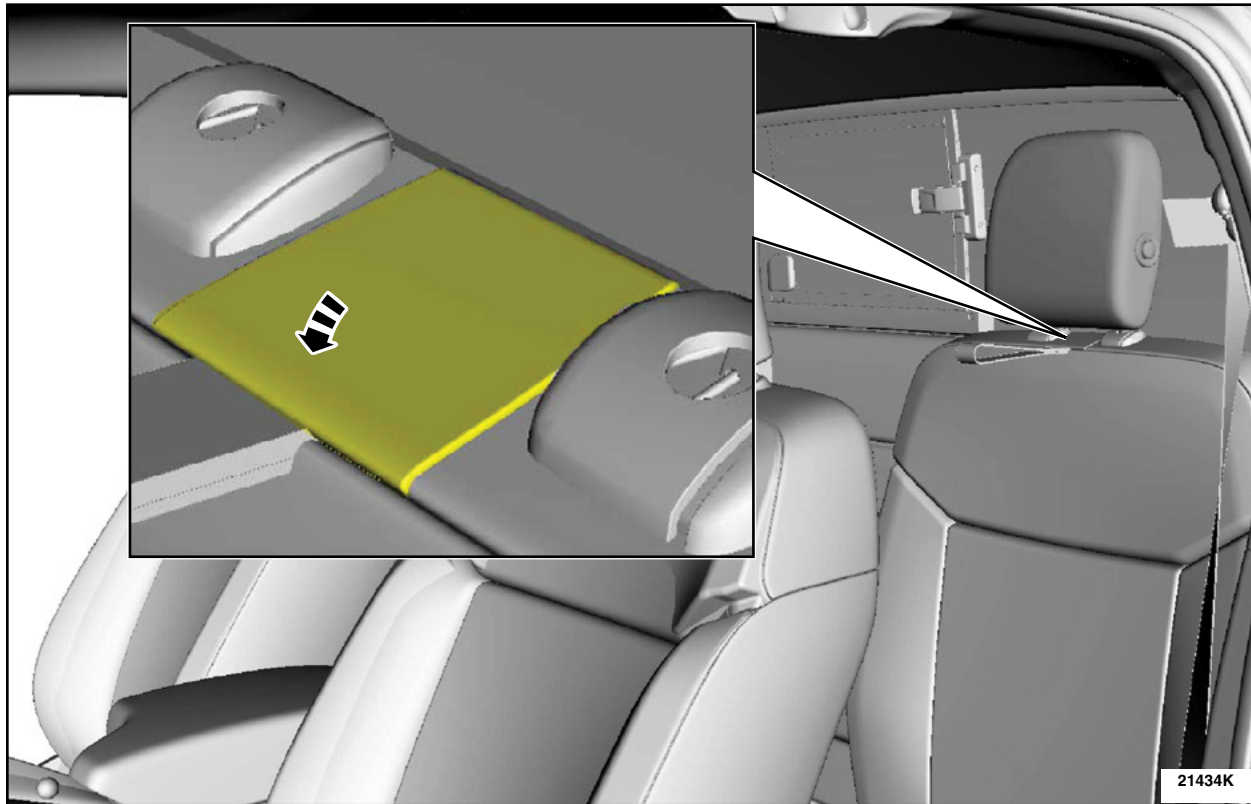

FIGURE 11

14. Install both the RH and the LH rear seat cushions. Please follow the WSM procedures in Section 501-10B. This completes the recall.

IMPORTANT NOTE: Federal law prohibits selling motor vehicle parts or components that are under safety, compliance, or emissions recall. Unless a part is requested to be returned to Ford, all parts replaced under this FSA must be scrapped in accordance with all applicable local, state and federal environmental protection and hazardous material regulations. Refer to the Parts Retention, Return, & Scrapping section of the FSA dealer bulletin for further information.

