



Volvo Car Customer Service

QB Instruction VCC-521069-1

Title	Fuse	Page	1 (5)
Action	Replacement	Operation number:	97766-2

Issue	Date	Reason
1	2021-05	First issue

Affected vehicles

Model year	Model
2019, 2020	S60 (19-)
2019, 2020	S90 (17-)
2019, 2020	S90L
2019, 2020	V60 (19-)
2019, 2020	V60 Cross Country (19-)
2019, 2020	V90 (17-)
2019, 2020	V90 Cross Country
2019, 2020	XC60 (18-)
2019, 2020	XC90 (16-)

Materials

Materials	Qty.	Part No.	Notes
Fuse	1.0	31346549	

Color symbols

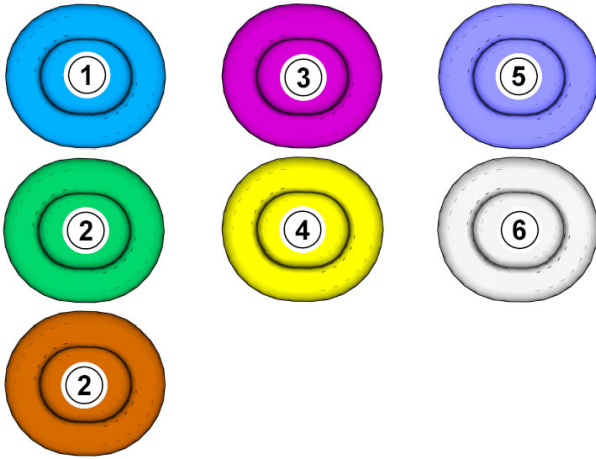

Note! This colour chart displays (in colour print and electronic version) the importance of the different colours used in the images of the method steps.

- 1 . Used for focused component, the component with which you will do something.
- 2 . Used as extra colors when you need to show or differentiate additional parts.
- 3 . Used for attachments that are to be removed/installed. May be screws, clips, connectors, etc.
- 4 . Used when the component is not fully removed from the vehicle but only hung to the side.
- 5 . Used for standard tools and special tools.
- 6 . Used as background color for vehicle components.

Removal

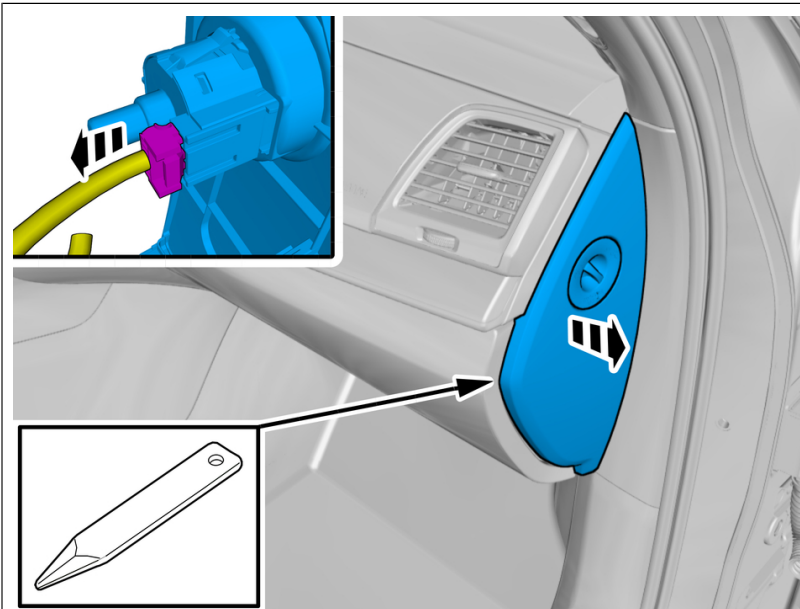

Disconnect the connector.
Remove the marked part.

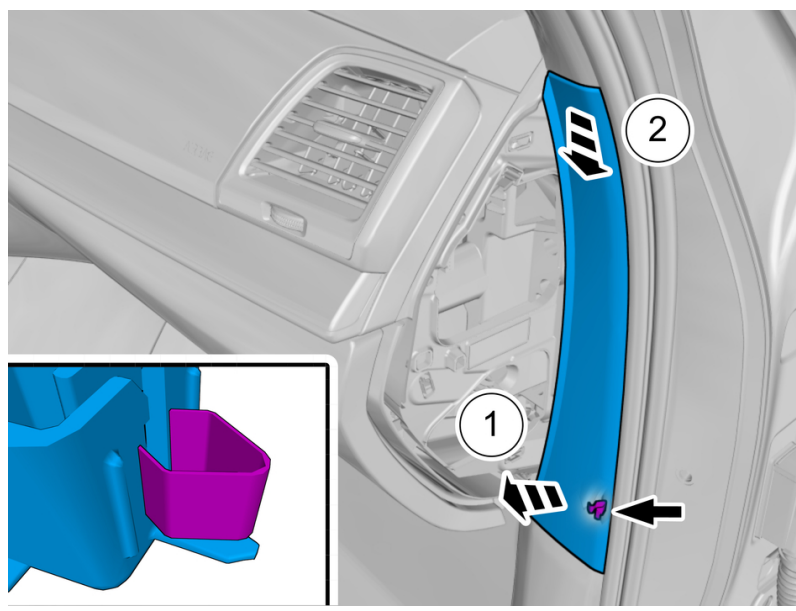

Remove the marked part.

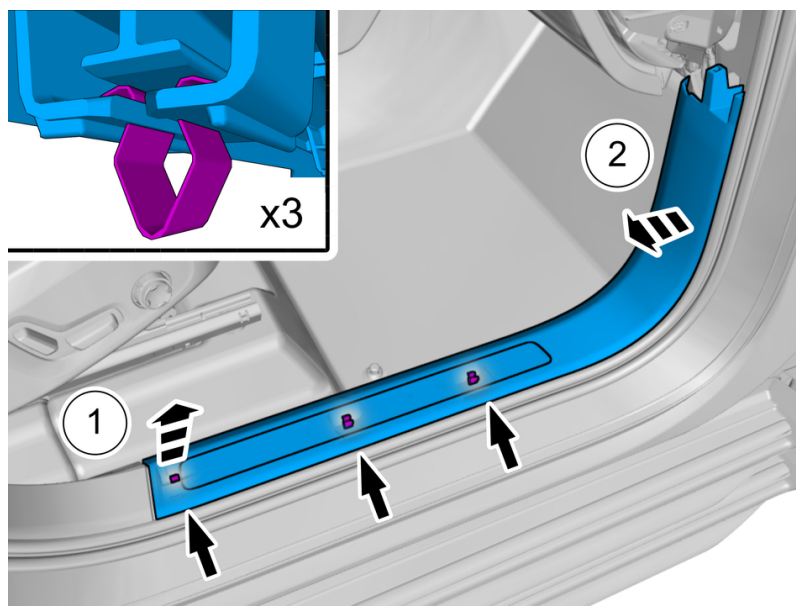

Remove the marked part.

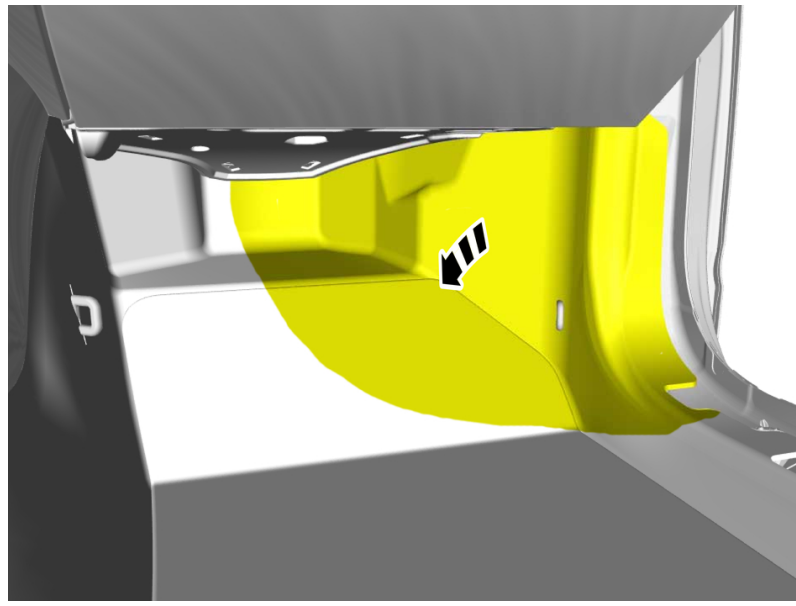

Fold the carpet aside.

Alternative 1

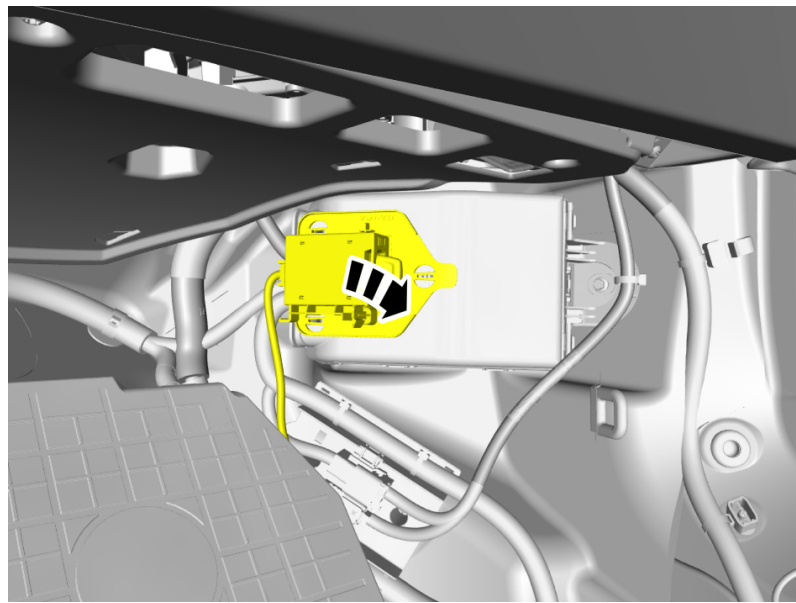

Fold marked part aside.

All vehicles

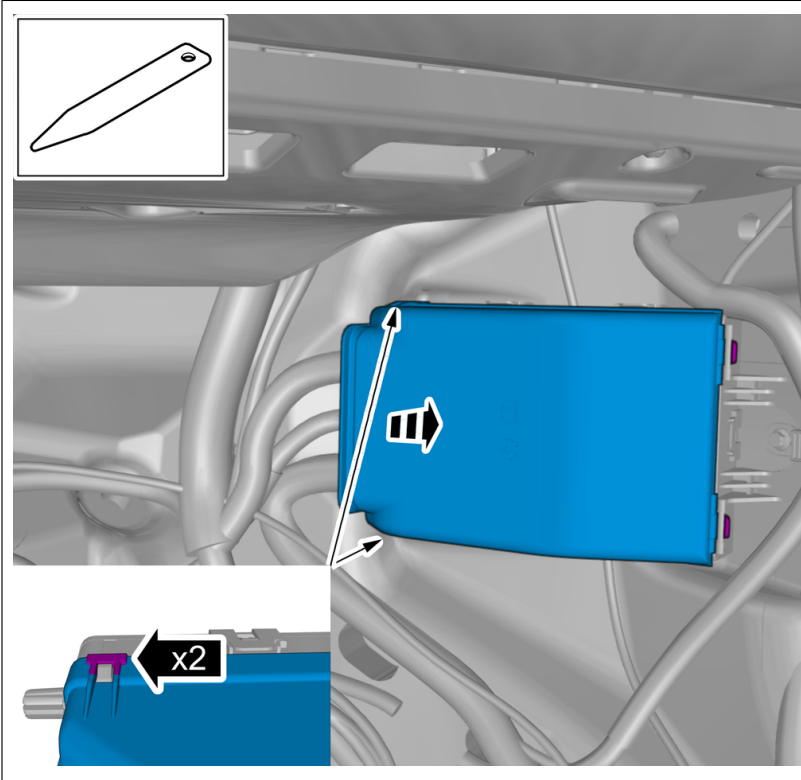

Remove the marked part.

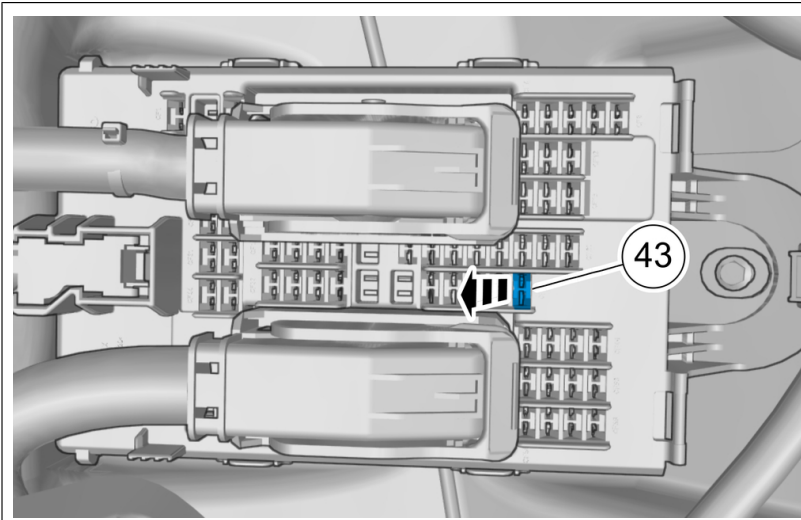

Remove the fuse for the fuel pump (FP).

Reinstall the removed parts in reverse order.