



David J. Johnson
 Director
 Service Engineering Operations
 Ford Customer Service Division

Ford Motor Company
 P. O. Box 1904
 Dearborn, Michigan 48121

June 21, 2021

TO: All U.S. Ford and Lincoln Dealers

**SUBJECT: NEW VEHICLE DEMONSTRATION / DELIVERY HOLD
 Safety Recall 21S24 – Supplement #1**
 Certain 2013 through 2022 Model Year Transit Connect Vehicles Equipped with a
 2.5L Engine and 6F35 Transmission
 Shifter Cable Bushing Replacement and Protective Cap

**REF: NEW VEHICLE DEMONSTRATION / DELIVERY HOLD
 Safety Recall 21S24**
 Dated May 25, 2021

New! REASON FOR THIS SUPPLEMENT

Parts: All parts are now on open order.

AFFECTED VEHICLES

Vehicle	Model Year	Assembly Plant	Build Dates
Transit Connect	2013-2022	Valencia	April 22, 2013 through April 30, 2021

Affected vehicles are identified in OASIS and FSA VIN Lists.

REASON FOR THIS SAFETY RECALL

In some of the affected vehicles, the shifter cable bushing in the transmission end may be damaged or missing. A damaged or missing bushing could prevent the shifter from moving the transmission to the intended gear position. The transmission may not be in the park position, even though the shifter position indicates that the vehicle was shifted to park.

This condition could allow a customer to turn the vehicle off and exit the vehicle with no instrument panel warning message or warning chime indicating the vehicle is not secured in park. This could result in unintended vehicle movement, increasing the risk of injury or crash.

SERVICE ACTION

Before demonstrating or delivering any new in-stock vehicles involved in this recall, dealers are to replace the bushing and install the protective service cap over the selector at the transmission end of the shifter cable. This service must be performed on all affected vehicles at no charge to the vehicle owner.

NOTE: If vehicle already had the shifter cable bushing or shifter cable replaced, this program will still need to be completed with new bushing and installation of a protective cap.

OWNER NOTIFICATION MAILING SCHEDULE

Owner letters are expected to be mailed the week of June 28, 2021. Dealers should repair any affected vehicles that arrive at their dealerships, whether or not the customer has received a letter.

PLEASE NOTE:

Federal law requires dealers to complete this recall service before a new vehicle is delivered to the buyer or lessee. Violation of this requirement by a dealer could result in a civil penalty of up to \$21,000 per vehicle. Correct all vehicles in your new vehicle inventory before delivery.

New! ATTACHMENTS

Attachment I: Administrative Information
Attachment II: Labor Allowances and *Parts Ordering Information*
Attachment III: Technical Information
Owner Notification Letters
Recall Reimbursement Plan

QUESTIONS & ASSISTANCE

For questions and assistance, contact the Special Service Support Center (SSSC) via the SSSC Web Contact Site. The SSSC Web Contact Site can be accessed through the Professional Technician System (PTS) website using the SSSC link listed at the bottom of the OASIS VIN report screen or listed under the SSSC tab.

Sincerely,



David J. Johnson

NEW VEHICLE DEMONSTRATION / DELIVERY HOLD - Safety Recall 21S24 – Supplement #1
Certain 2013 through 2021 Model Year Transit Connect with a 2.5L Engine and 6F35 Transmission
Shifter Cable Bushing Replacement and Protective Cap

OASIS ACTIVATION

OASIS was activated on May 25, 2021

FSA VIN LISTS ACTIVATION

FSA VIN Lists were made available through <https://web.fsavinlists.dealerconnection.com> on May 25, 2021. Owner names and addresses will be available by week of July 12, 2021.

NOTE: Your FSA VIN Lists may contain owner names and addresses obtained from motor vehicle registration records. The use of such motor vehicle registration data for any purpose other than in connection with this recall is a violation of law in several states, provinces, and countries. Accordingly, you must limit the use of this listing to the follow-up necessary to complete this recall.

SOLD VEHICLES

- Ford has not issued instructions to stop selling/delivering or driving used vehicles under this safety recall. Owners should contact their dealer for an appointment to have their vehicles remedied as soon as practicable. Owners can continue to safely drive their vehicles while using parking brake.
- Immediately contact any of your affected customers whose vehicles are not on your VIN list but are identified in OASIS. Give the customer a copy of the Owner Notification Letter (when available) and schedule a service date.
- Correct other affected vehicles identified in OASIS which are brought to your dealership.
- Dealers are to prioritize repairs of customer vehicles over repairs of new and used vehicle inventory.

STOCK VEHICLES

- Correct all affected units in your new vehicle inventory before delivery.
- Use OASIS to identify any affected vehicles in your used vehicle inventory.

DEALER-OPERATED RENTAL VEHICLES

The Fixing America's Surface Transportation (FAST) Act law effective June 2016 prohibits a rental company from selling, renting or leasing vehicles subject to a safety or compliance recall. Please consult your legal counsel for legal advice.

TITLE BRANDED / SALVAGED VEHICLES

Affected title branded and salvaged vehicles are eligible for this recall.

RENTAL VEHICLES

Rental vehicles are not approved for this program.

NEW VEHICLE DEMONSTRATION / DELIVERY HOLD - Safety Recall 21S24 – Supplement #1
Certain 2013 through 2021 Model Year Transit Connect with a 2.5L Engine and 6F35 Transmission
Shifter Cable Bushing Replacement and Protective Cap

OWNER REFUNDS

**This safety recall must still be performed, even if the owner has paid for a previous repair.
Claiming a refund will not close the recall on the vehicle.**

- Ford Motor Company is offering a refund for owner-paid repairs covered by this recall if the repair was performed prior to the date indicated in the reimbursement plan, which is posted with this bulletin. Owners are directed to seek reimbursement through authorized dealers or, at their option, directly through Ford Motor Company at P.O. Box 6251, Dearborn, MI 48121-6251.
- Refunds will only be provided for the cost associated with shifter cable or shifter cable bushing replacement.

ADDITIONAL REPAIR (LABOR TIME AND/OR PARTS)

Additional repairs identified as necessary to complete the FSA should be managed as follows:

- For related damage and access time requirements, refer to the Warranty and Policy Manual / Section 6 – Ford & Lincoln Program Policies / General Information & Special Circumstances for FSA's / Related Damage.
- For vehicles within new vehicle bumper-to-bumper warranty coverage, no SSSC approval is required, although related damage must be on a separate repair line with the "Related Damage" radio button checked.
 - Ford vehicles – 3 years or 36,000 miles
- For vehicles outside new vehicle bumper-to-bumper warranty coverage, submit an Approval Request to the SSSC Web Contact Site prior to completing the repair.

CLAIMS PREPARATION AND SUBMISSION

- **Claim Entry:** Enter claims using Dealer Management System (DMS) or One Warranty Solution (OWS) online.
 - When entering claims, select claim type 31: Field Service Action. The FSA number 21S24 is the sub code.
 - For additional claims preparation and submission information, refer to the Recall and Customer Satisfaction Program (CSP) Repairs in the OWS User Guide.
- **Related Damage/Additional labor and/or parts:** Must be claimed as Related Damage on a separate repair line from the FSA with same claim type and sub code as described in Claim Entry above.

IMPORTANT: Click the Related Damage Indicator radio button.

- **Refunds:** Submit refunds on a separate repair line.
 - Program Code: 21S24
 - Misc. Expense: REFUND
 - Misc. Expense: ADMIN
 - Misc. Expense: 0.2 Hrs.
 - Multiple refunds should be submitted on one repair line and the invoice details for each repair should be detailed in the comments section of the claim.

NEW VEHICLE DEMONSTRATION / DELIVERY HOLD - Safety Recall 21S24 – Supplement #1

Certain 2013 through 2021 Model Year Transit Connect with a 2.5L Engine and 6F35 Transmission
Shifter Cable Bushing Replacement and Protective Cap

LABOR ALLOWANCES

Description	Labor Operation	Labor Time
Replace Shifter Cable Bushing, Install Protective Cap and Adjust Shifter	21S24B	0.5 Hours

New! PARTS REQUIREMENTS / ORDERING INFORMATION

All parts are now on open order.

NOTE: If vehicle has had the shifter cable bushing or shifter cable replaced previously this program will still need to be completed with new bushing and installation of a protective cap.

Part Number	Description	Order Quantity	Claim Quantity
DG9Z-7K340-A	Shifter Cable Bushing	1	1
DG9Z-7S004-A	Protective Cap	1	1

Order your parts through normal order processing channels. To guarantee the shortest delivery time, an emergency order for parts must be placed.

ADDITIONAL PARTS ORDERING INFORMATION

NOTE: Although Shifter Cable Hold Down Bracket damage is not likely, we are making dealers aware of part availability in lieu of replacing the entire shifter cable. Less than 5% of the affected vehicle population is expected to require the Shifter Cable Hold Down Bracket.

Part Number	Description	Order Quantity	Claim Quantity
DG9Z-7H181-A	Shifter Cable Hold Down Bracket (Only replace if damaged when removing shifter cable.)	1	1

DEALER PRICE

For latest prices, refer to DOES II.

PARTS RETENTION, RETURN, & SCRAPPING

Follow the provisions of the Warranty and Policy Manual, Section 1 - WARRANTY PARTS RETENTION AND RETURN POLICIES. If a replaced part receives a scrap disposition, the part must be scrapped in accordance with all applicable local, state and federal environmental protection and hazardous material regulations. Federal law prohibits selling motor vehicle parts or components that are under safety, compliance, or emissions recall.

EXCESS STOCK RETURN

Excess stock returned for credit must have been purchased from Ford Customer Service Division in accordance with Policy Procedure Bulletin 4000.

NEW VEHICLE DEMONSTRATION / DELIVERY HOLD - Safety Recall 21S24 – Supplement #1
Certain 2013 through 2021 Model Year Transit Connect with a 2.5L Engine and 6F35 Transmission
Shifter Cable Bushing Replacement and Protective Cap

REPLACED FSA PARTS INSPECTION AND SIGN OFF

Effective March 1st 2021 all parts replaced as part of an FSA repair with a repair order open date of March 1st 2021 or later must be inspected and signed off on the repair order by a member of your dealers fixed operations management team or an employee the task has been delegated to. If the task is to be delegated to a non-management employee, the employee needs to be someone other than the technician who completed the repair and needs to understand the importance of completing this task consistently and accurately.

- All parts replaced as part of an FSA repair should be returned to the parts department following the Warranty Parts Retention and Return Policies.
- Inspect the replaced parts to verify the FSA repair was completed.
- If the FSA repair is found to be complete, the designated employee signs the repair order line or parts return stamp area (electronic or hand signed) for the FSA repair indicating the parts were inspected and validated to have been replaced.
- After the parts have been inspected, they should be handled based on the guidance in the parts status report in the Online Warranty System (Hold, Return, CORE, Scrap, etc.).
- This process is subject to review during warranty audits for FSA repairs with a repair order open date of March 1st 2021 or later. Any eligible FSA claims requiring parts replacement, found not to have been inspected and signed off during a warranty audit will be subject to chargeback and consideration for enrollment into the Dealer Incomplete Recall Repair Process.

Note: Other approvals (electronic or handwritten) for add-on repair lines, dealer owned vehicle repairs, and repeat repairs do not qualify as FSA parts inspection approvals. The post repair FSA parts inspection process (electronic or handwritten) is independent from other warranty approval requirements. The approval by the designated employee implies that the FSA parts were found to be replaced and must be able to be clearly identified on the Repair Order. If multiple FSA's require approval on a single Repair Order, each applicable occurrence will require individual post repair approval by the designated employee.

CERTAIN 2013-2021 MODEL YEAR TRANSIT CONNECT EQUIPPED WITH A 2.5L ENGINE AND A 6F35 TRANSMISSION — SHIFTER CABLE BUSHING REPLACEMENT AND PROTECTIVE CAP

SERVICE PROCEDURE

All Vehicles

1. Apply the parking brake, chock wheels to make sure vehicle does not roll.
2. Position the gear shift lever in Drive (D).
3. Remove the air cleaner assembly. Please follow the Workshop Manual (WSM) procedures in Section 303-12.
4. Remove the air cleaner outlet pipe. Please follow the Workshop Manual (WSM) procedures in Section 303-12.
5. Disconnect the selector lever cable from the transmission manual lever and the bracket. See Figure 1.
 1. Remove the selector lever cable bracket bolt.
 2. Disengage the selector lever cable holding clip.
 - Use caution when removing hold down bracket to avoid damage. Hold down bracket is available separate of shift cable.
 3. Disconnect the selector lever cable.
 - Torque to 62 lb.in (7 Nm).

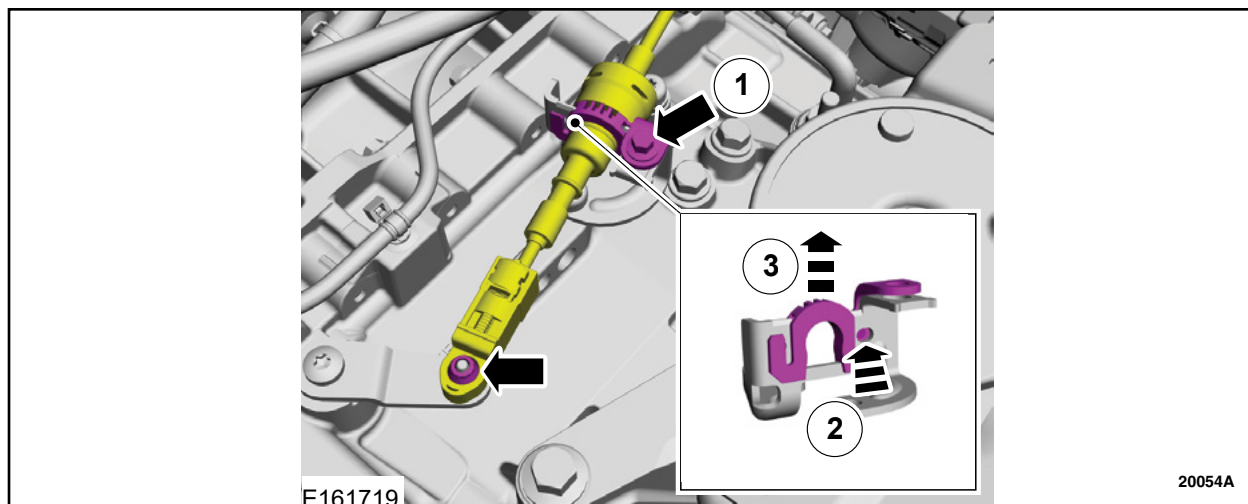

FIGURE 1



NOTE: Selector Lever Cable Bushing Replacement/Orientation. See Figure 2.

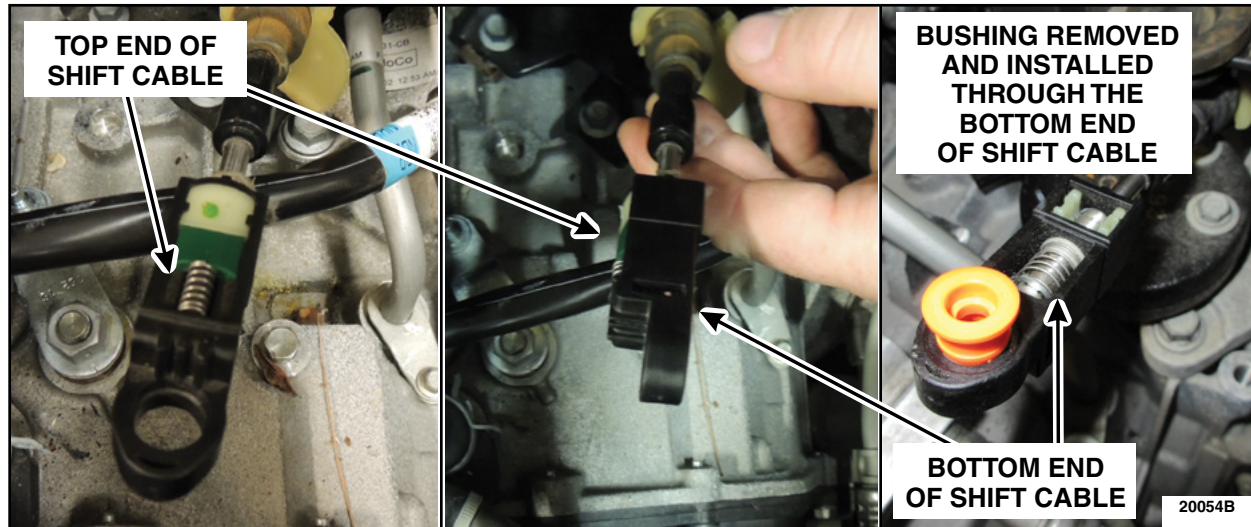

FIGURE 2

2013 Model Year Vehicles Only

6. Using a pair of Straight Jaw Adjustable pliers and a 15mm shallow socket push the bushing partially out of the selector lever cable end. See Figure 3.

- Use caution not to damage the shifter cable during this procedure.
- Inspect for damage before installing the new shifter cable bushing.

NOTE: For all 2013 Transit Connect vehicles equipped with original shift cable, the bushing maybe taller than the replacement bushing.

NOTE: The 15mm socket will rest against the hard plastic bottom end of shift cable, and will be large enough to allow bushing to be pressed partially out.

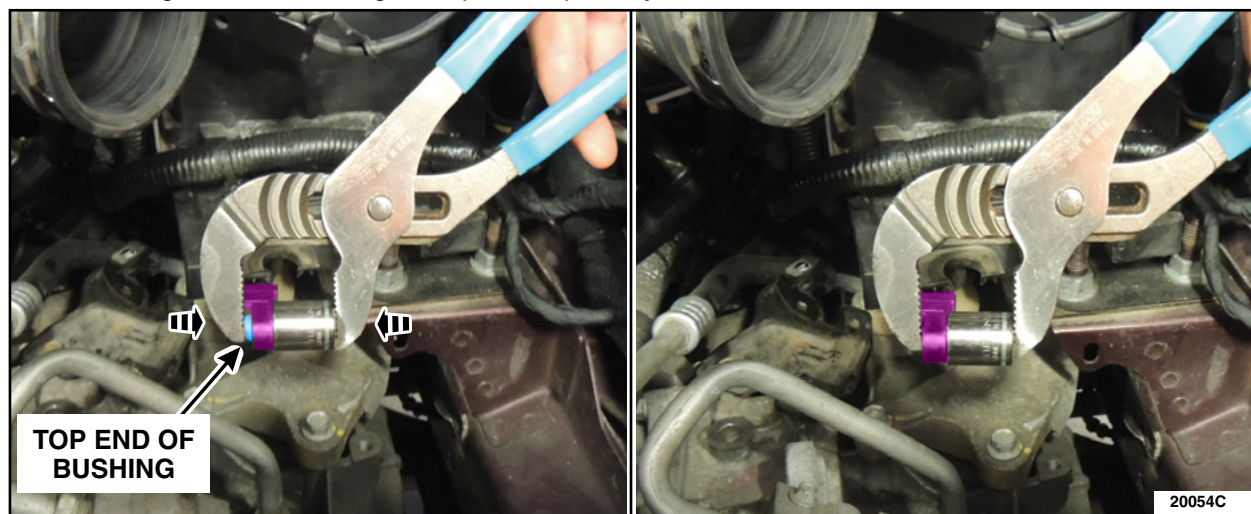

FIGURE 3



7. Turn the selector lever cable end over and using a punch push the bushing the rest of the way out of the selector lever cable end. See Figure 4. Proceed to Step 9.

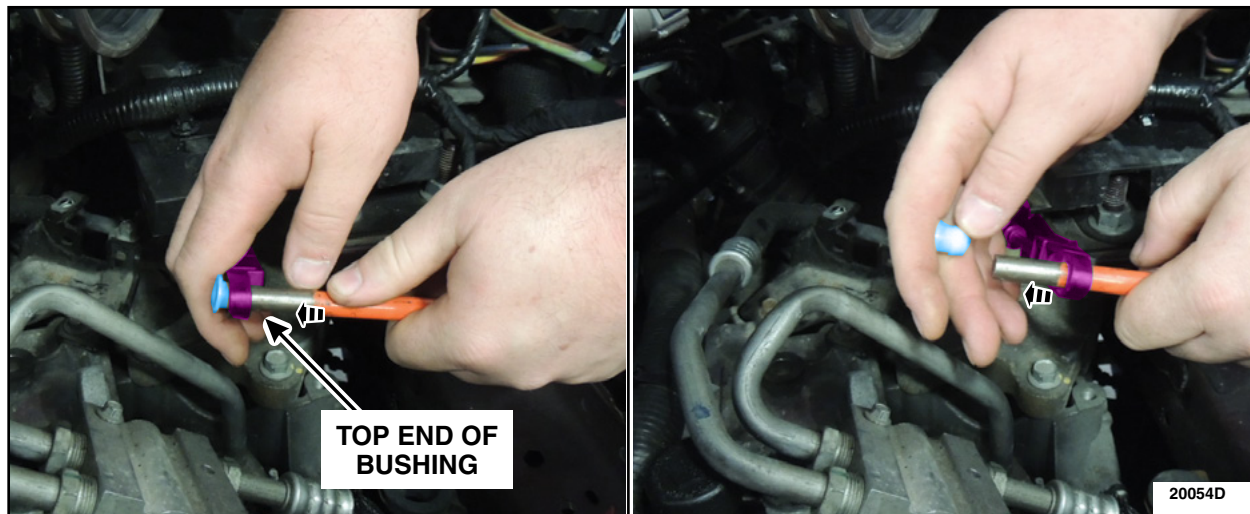

FIGURE 4

2014-2021 Model Year Vehicles Only

8. Press out the shifter cable bushing using one of the two methods below.
- Using a 5mm and a 15mm socket with Straight Jaw Adjustable pliers the bushing can be pressed out of the shifter cable end. The 5mm socket will fit into the small part of the bushing on top, the 15mm will go against the bottom of the shifter cable end, make sure to have socket centered with the bushing to allow clearance of the bushing shoulder as it is being pressed out. See Figures 5 and 6.
 - Using a tool such as a Lisle 38350 - Exhaust Hanger Removal plier to press bushing out. By viewing Figure 7 the shoulder of bushing is positioned upward, small end of plier is pressing bushing out. Proceed to Step 9.
- Use caution not to damage the shifter cable during this procedure.
 - Inspect for damage before installing the new shifter cable bushing.

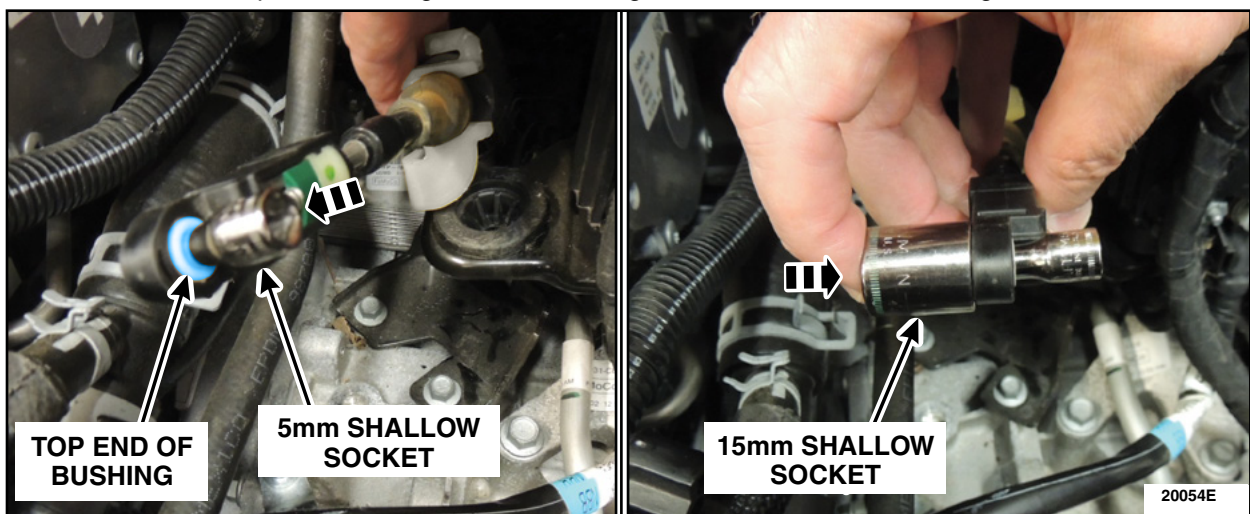

FIGURE 5



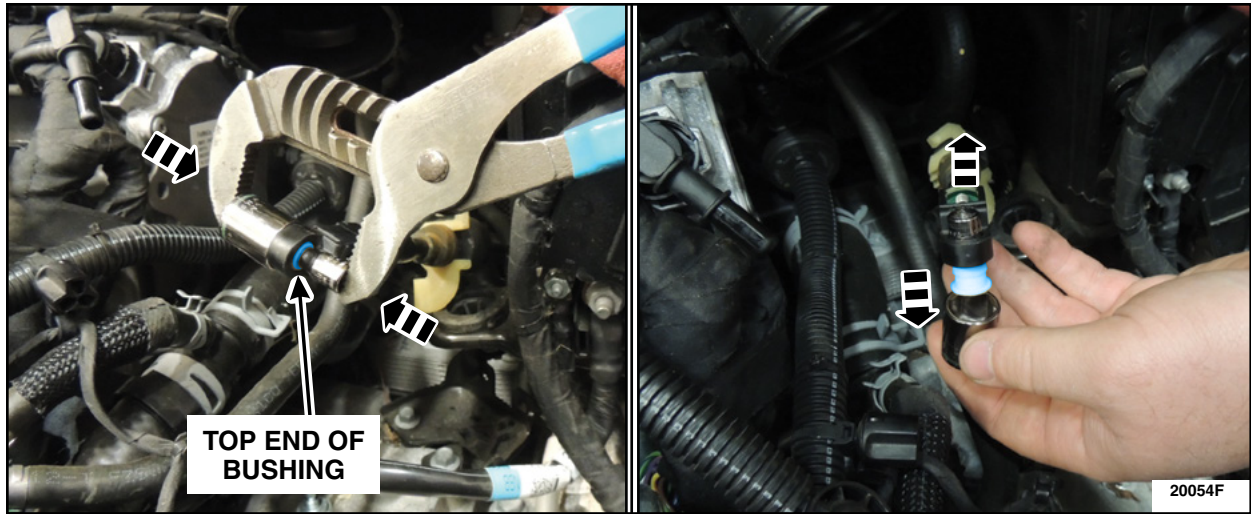

FIGURE 6

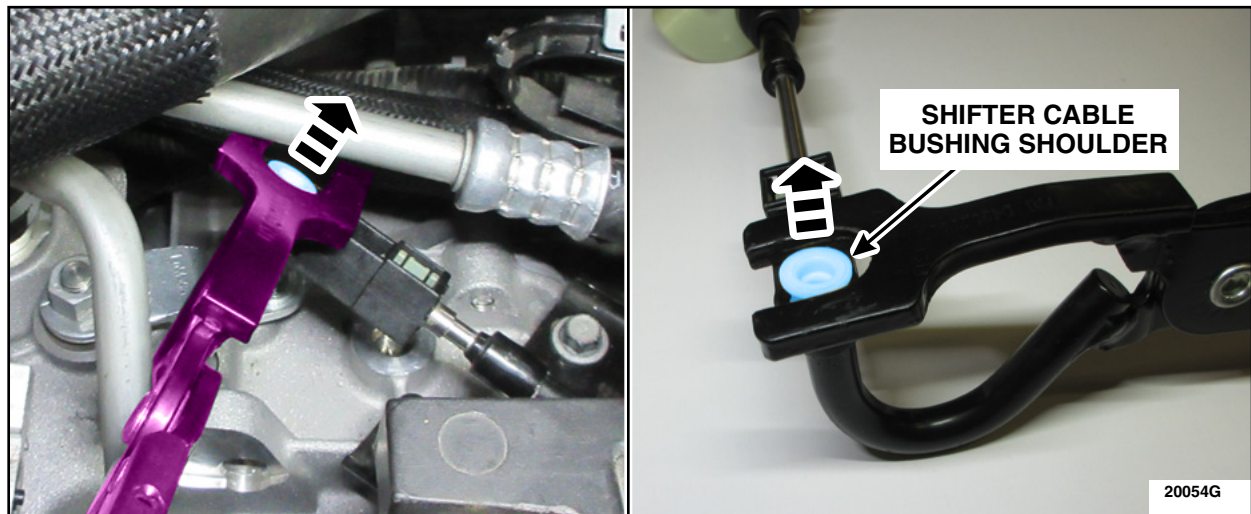

FIGURE 7



All Vehicles

9. Using your hands only, install the new selector lever cable bushing. Do not use any grease to install, the bushing and cable end should be dry. See Figure 8.

- Visually check shifter cable end for any signs of damage. If damage to the shifter cable end is found, please call the Special Service Support Center (SSSC).

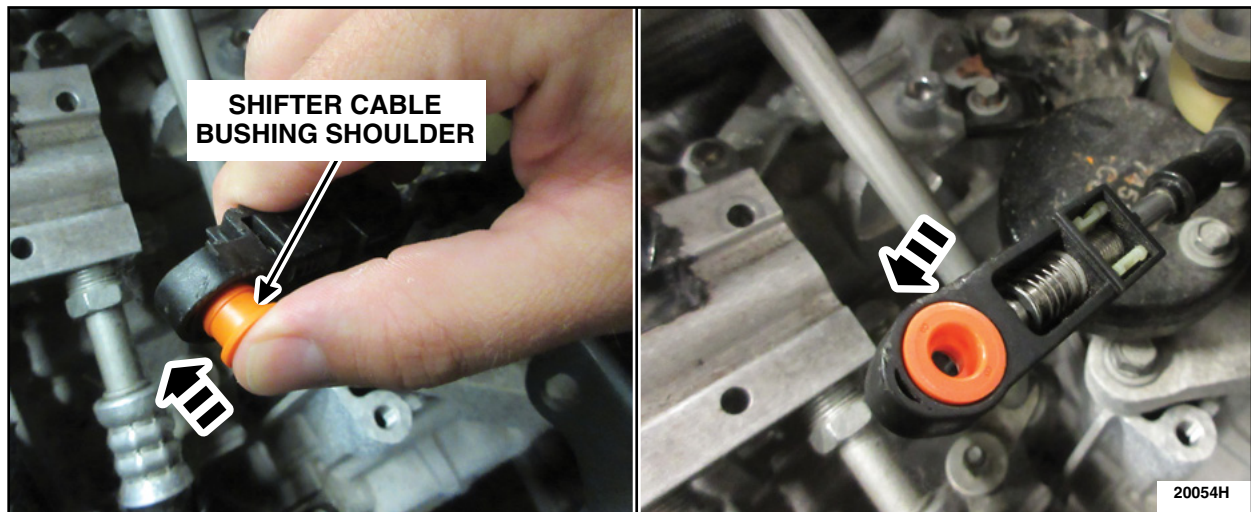

FIGURE 8

10. The vehicle's transmission gear selector lever should be in Drive position from Step 2, if not, position the selector lever to Drive (D). See Figure 9.

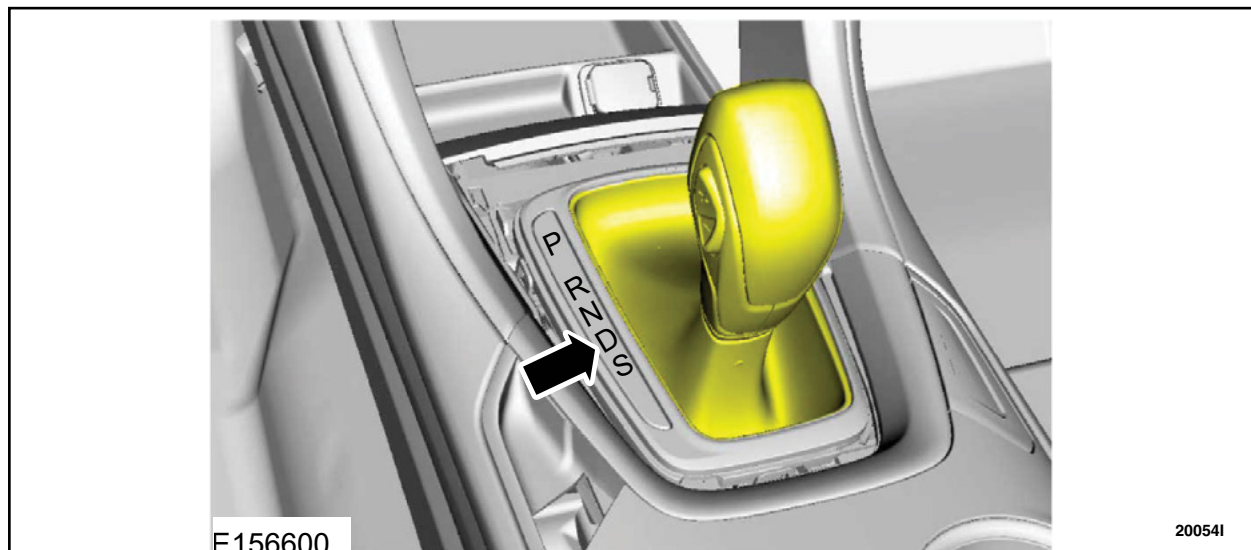

FIGURE 9



11. Rotate the manual control lever clockwise until it stops. See Figure 10.

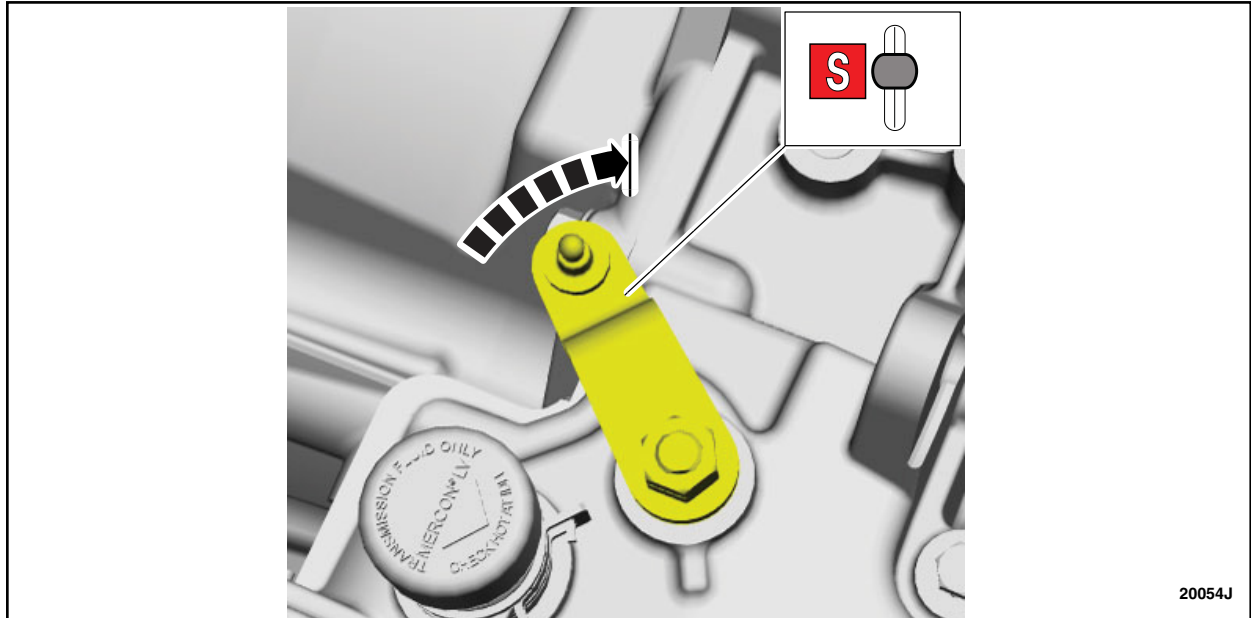

FIGURE 10

12. Rotate the manual control lever counterclockwise 1 detent into Drive (D). See Figure 11.

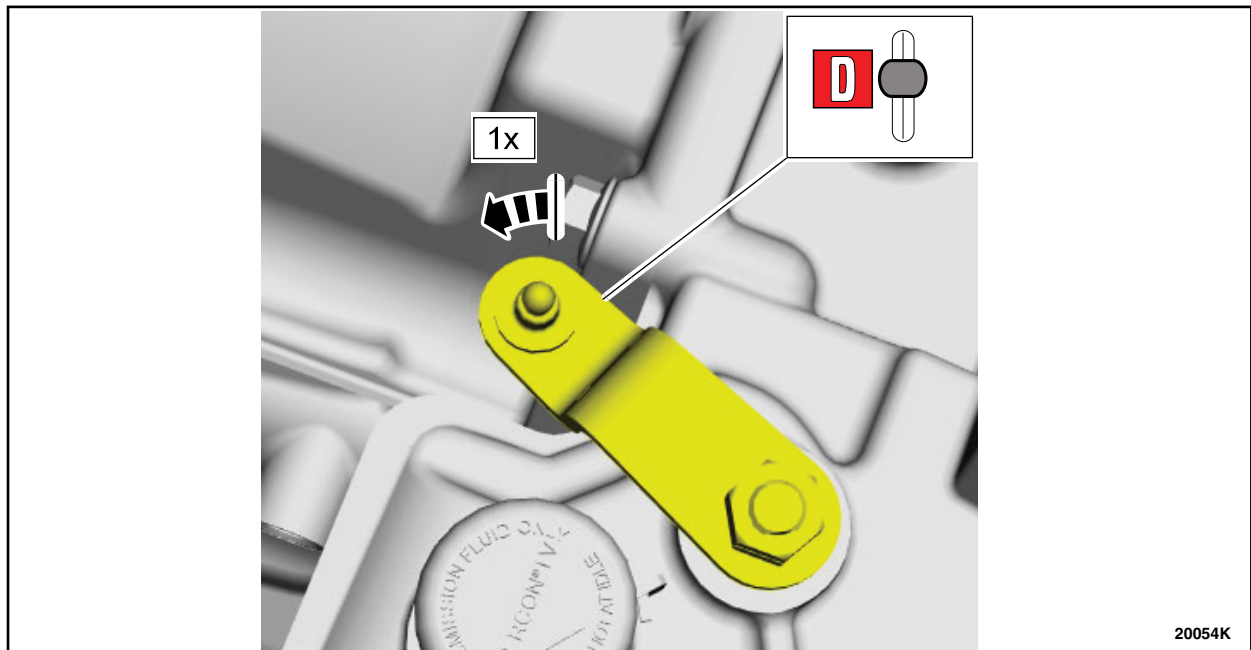

FIGURE 11



13. Release the selector lever cable adjuster lock. See Figure 12.

1. Carefully pry the adjuster lock tabs outward.
2. While holding the adjuster lock tabs outward, slide the lock out to unlock the selector lever cable.

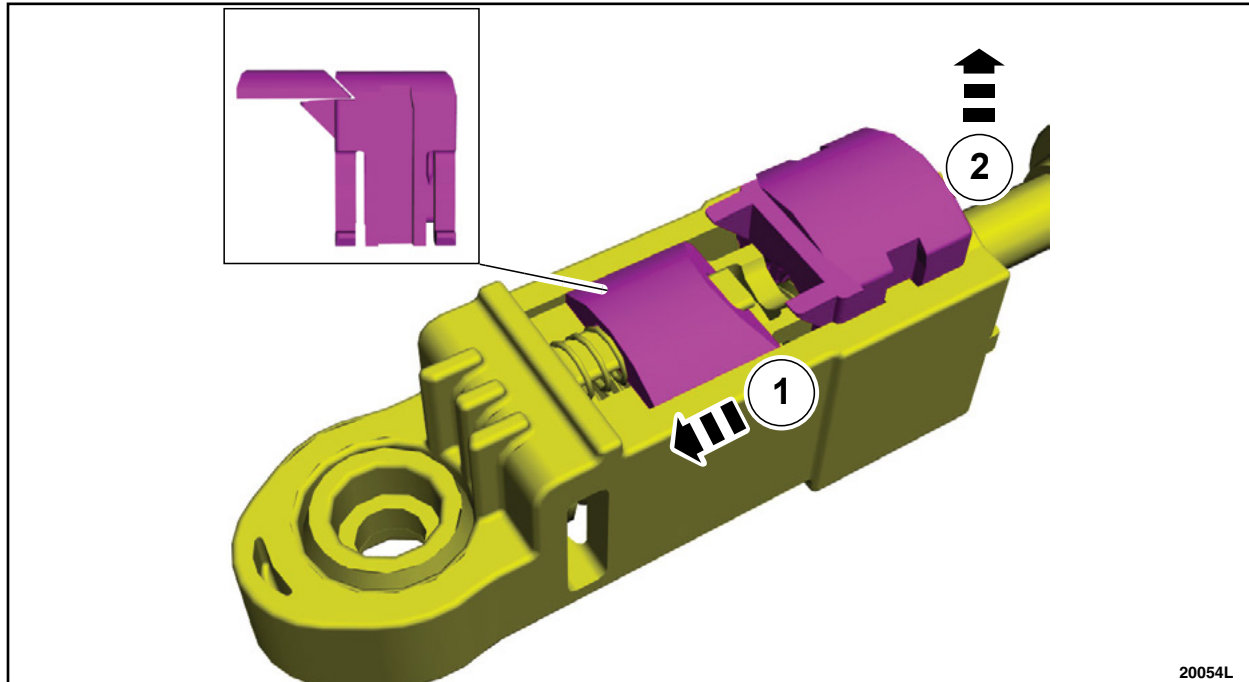

FIGURE 12

14. Connect the selector lever cable to the manual control lever. See Figure 13.

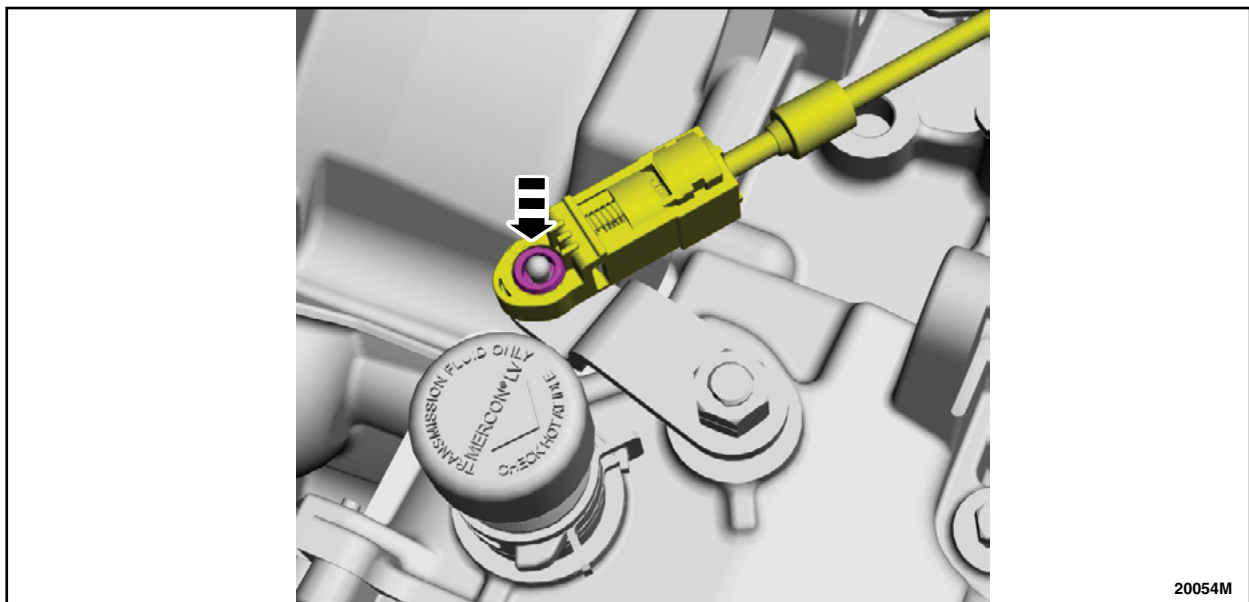

FIGURE 13



15. Slide the adjuster tab in place to lock the selector lever cable. See Figure 14.

NOTE: Visually inspect cable end and give a slight pull up to verify the bushing is fully seated.

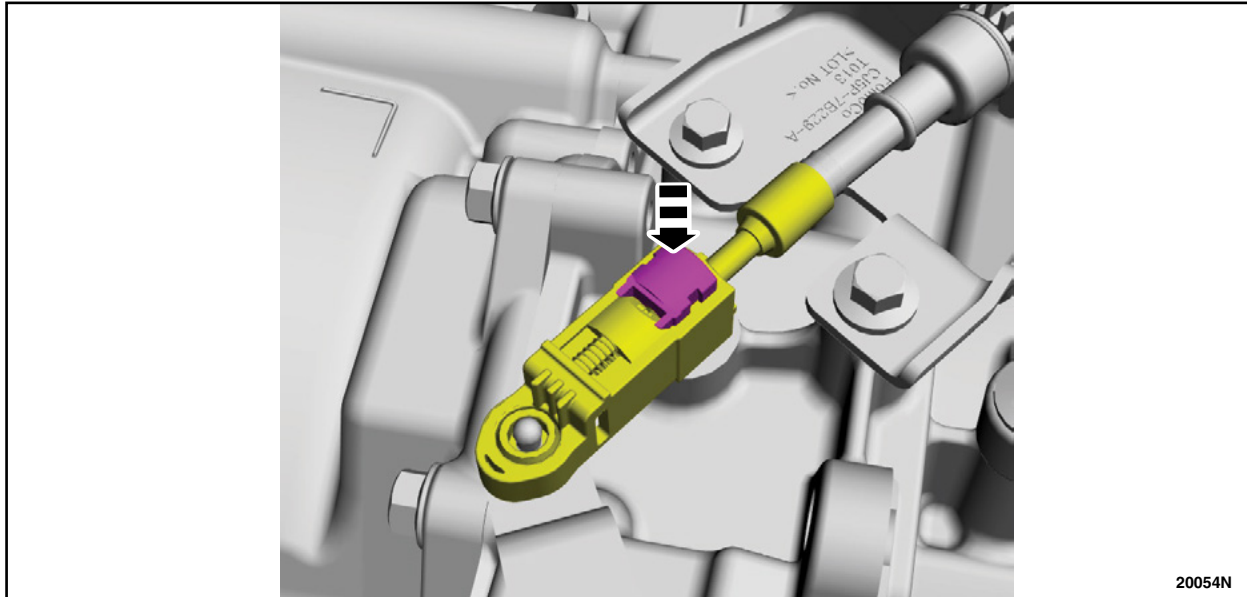

FIGURE 14

16. Install the new cap onto the selector lever cable adjuster. Clip one side into the adjuster body and then slide the other onto the housing until it snaps into place. The protective cap should cover the bushing and the terminal end of the adjuster. See Figure 15.

17. Verify installation by checking the cap is retained by the adjuster body.

NOTE: Selector lever cable removed for clarity.

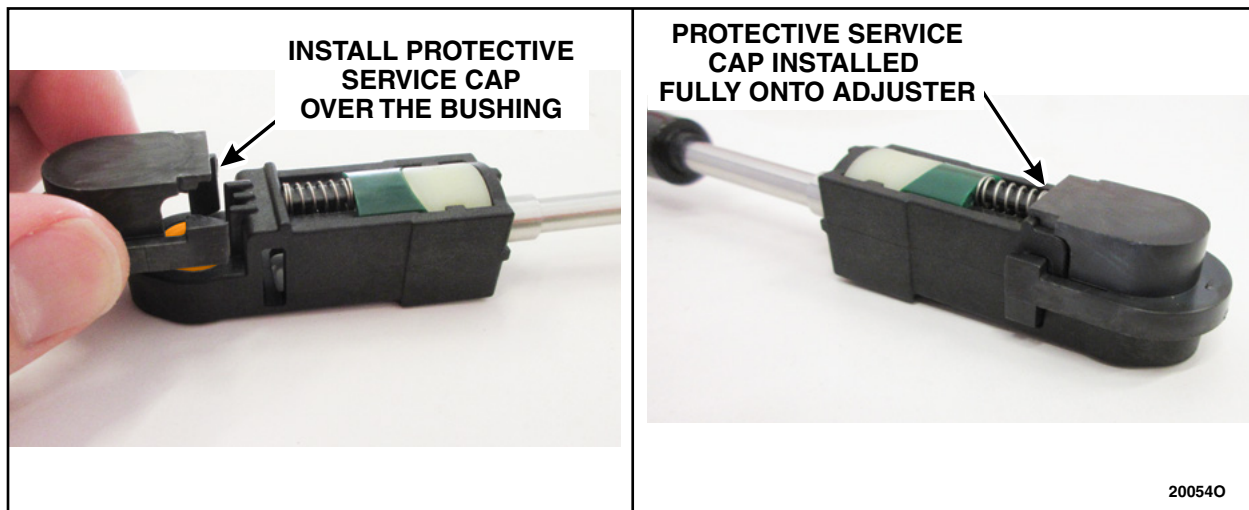

FIGURE 15

18. Reassemble the vehicle by reversing the removal procedure.

19. Verify that the engine starts in Park (P) and Neutral (N) only and that the reverse lamps illuminate in Reverse (R).



Ford Motor Company
Recall Reimbursement Plan for 21S24

Ford and Lincoln dealers are in the best position to quickly and efficiently process reimbursement requests. However, federal legislation requires all motor vehicle manufacturers to establish processes through which customers may seek recall reimbursement directly from the manufacturer or from the dealers.

Regarding the specific reimbursement plan for Recall # 21S24, owners who have paid for service to remedy the defect or noncompliance must have had that service performed prior to July 12, 2021. After this date, if repairs related to this recall are performed by a non-Ford repair facility in an emergency situation, customers must submit any refund requests through their dealership. As required by this federal regulation, Ford Motor Company submitted the details of its latest General Recall Reimbursement Plan in a letter to the National Highway Traffic Safety Administration (NHTSA) in February 2019. The following is the text of that letter and the Plan:

General Recall Reimbursement Plan
(As submitted to the NHTSA)

Pursuant to the requirements set forth in 49 CFR Part 573 and Part 577 of the Code of Federal Regulations, Ford Motor Company (Ford) is submitting required information pertaining to our general reimbursement plan for the cost of remedies paid for by vehicle owners before they are notified of a related safety recall.

Set forth below is Ford's general plan to reimburse owners and purchasers for costs incurred for remedies in advance of notification of potential safety-related defects or noncompliances pursuant to Part 573.6 (c)(8)(i). This plan has not changed since our February 20, 2019 submission.

Reimbursement Notification

Ford's notice to a vehicle owner in accordance with 49 CFR Part 577 will indicate that Ford is offering a refund if the owner paid to have service to remedy the defect or noncompliance prior to a specified ending date. In accordance with Part 573.13 (c)(2), this ending date will be defined as a minimum of ten calendar days after the date on which Ford mailed the last of its Part 577 notifications to owners, and will be indicated in the specific reimbursement plan available to owners for an individual recall. This notice will direct owners to seek eligible reimbursement through authorized dealers or, at their option, directly through Ford at the following address:

Ford Motor Company
P.O. Box 6251
Dearborn, MI 48121-6251

Ford notes that this rule allows for the identification of a beginning date for reimbursement eligibility. Under the rule, an owner who paid to remedy the defect or noncompliance prior to the identified beginning date would not be eligible for reimbursement. Ford generally has not established such a beginning date for reimbursement eligibility and does not presently anticipate changing this general policy. However, in any case where Ford determines a beginning date is appropriate, Ford will indicate that date in the owner notice. As permitted by 577.11(e), Ford may not include a reimbursement notification when all vehicles are well within the warranty period, subject to approval by the agency.

Costs to be Reimbursed

For vehicles, reimbursement will not be less than the lesser of:

- The amount paid by the owner for the remedy that specifically addressed and was reasonably necessary to correct the defect or noncompliance that is the subject of the recall, or
- The cost of parts for the remedy (to be no more than the manufacturer's list retail price for authorized part(s), plus associated labor at local labor rates, miscellaneous fees (such as disposal of waste) and taxes.

For replacement equipment, reimbursement will be the amount paid by the owner for the replacement item (limited by the amount of the retail list price of the defective or noncompliant item that was replaced, plus taxes, where the brand or model purchased by the owner was different than the brand or model that was the subject of the recall). If the item of motor vehicle equipment was repaired, the reimbursement provisions identified above for vehicles will apply.

Ford notes that costs incurred by the owner within the period during which Ford's original or extended warranty would have provided for a free repair of the problem will not be eligible for reimbursement, as provided by Part 573.13 (d)(1).

Entities Authorized to Provide Reimbursement

Ford will continue to use authorized dealers to reimburse owners under the specific reimbursement plans for a particular recall, and will encourage owners to pursue requests for reimbursement directly through dealers to expedite reimbursement. Ford will also provide a mailing address to which customers can, at their option, send requests for reimbursement directly to Ford, as previously noted. Requests for reimbursement sent directly to Ford may take up to 60 days to process. Whether the owner chooses to pursue reimbursement requests through a dealer or directly through Ford, the owner will be directed to submit the required documentation, upon which reimbursement eligibility will be determined.

Required Documentation

The reimbursement determination will depend upon the information provided by the customer. Consistent with Part 573.13 (d)(4) the following information must be submitted:

- Claimant name and address
- Vehicle make, model, and model year
- Vehicle identification number (VIN) and, for replacement equipment, a description of such equipment or, for tires, the model, size and TIN (DOT code)
- Identification of the recall number (either the Ford recall number or the NHTSA recall number)
- Identification of the owner of the recalled vehicle at the time that the pre-notification remedy was obtained
- An original receipt for the pre-notification remedy that includes a breakdown of the amount for parts, labor, other costs and taxes, including costs for the replacement item. Where the receipt covers work other than to address the recall or noncompliance, Ford may require the claimant to separately identify costs that are eligible for reimbursement.
- If the remedy was obtained during the warranty period, documentation indicating that the warranty was not honored or the warranty repair did not correct the problem related to the recall.

Failure to submit all of the above information may result in denial of the reimbursement request.

Additional Information

The Part 577 required owner notice will provide a toll-free telephone number through which specific information about the reimbursement plan can be requested from Ford. This general reimbursement plan will be incorporated into notifications pursuant to Part 573.6 by reference. Information specific to an individual recall also may be incorporated into the Part 573.6 notification.