

# Product Safety Recall

## N192290990 Front Passenger Air Bag Inflator – US Only



**Release Date:** August 2021

**Revision:** 02

**Revision Description:** This bulletin has been updated in the parts, warranty, and service procedure sections. This update includes new labor codes for new part numbers for the HD Pickup Front Passenger Airbag Inflator Kit and bracket. The new requirement information for recording ALL replacement air bag inflator serial numbers under the Warranty Information section has also been added to this bulletin. Please discard all previous copies of N192290990.

**Attention:** It is a violation of Federal law for a dealer to deliver a new motor vehicle or any new or used item of motor vehicle equipment (including a tire) covered by this notification under a sale or lease until the defect or noncompliance is remedied.

All involved vehicles that are in dealer inventory must be held and not delivered to customers, dealer traded, or used for demonstration purposes until the repair contained in this bulletin has been performed on the vehicle.

Make	Model	Model Year		RPO	Description
		From	To		
Chevrolet	Silverado 2500/3500 HD	2007	2008		
GMC	Sierra 2500/3500 HD	2007	2008		

Involved vehicles are marked “open” on the Investigate Vehicle History screen in GM Global Warranty Management system. This site should always be checked to confirm vehicle involvement prior to beginning any required inspections and/or repairs.

<b>Condition</b>	TK Global LLC (“Takata”) has decided that a defect which relates to motor vehicle safety exists in certain 2007-2008 model year Chevrolet Silverado and GMC Sierra 2500/3500 series heavy duty pickup trucks. Takata has determined that some of the front passenger air bag inflators in these vehicles may experience an alteration over time, which could lead to overaggressive combustion in the event of an air bag deployment. This condition could create excessive internal pressure when the air bag is deployed, which could result in the body of the inflator rupturing upon deployment. In the event of an inflator rupture, metal fragments could pass through the air bag cushion material, which may result in injury or death to vehicle occupants.
<b>Correction</b>	Dealers will replace the front passenger air bag inflator module.

### Parts

Quantity	Part Name	Part No.
1	Front Passenger Air Bag Inflator Kit (Old Stock)	84255088*
- OR -		
1	Front Passenger Airbag Inflator Kit (Single Stage – HD pickup)	84594241*
1	Bracket (Required for Single Stage #84594241 Inflator Kit – HD Pickup Only)	84594242*

Parts required to complete this recall are to be obtained from General Motors Customer Care and Aftersales (GMCCA). Please refer to your “involved vehicles listing” before ordering parts. Parts are currently in limited supply, dealers are encouraged not to order recall parts for use as shelf stock. It is estimated that only 699 involved vehicles will require parts replaced. Parts may have quantity limiters in effect.

**IMPORTANT:** Due to flight restrictions for hazardous goods shipments, dealer orders may arrive via FedEx or with your normal PDC delivery. Therefore, dealers should order **ONLY as DRO = Daily Replenishment Order or CSO = Customer Special Order**. Please **do not place orders as SPAC**; it will delay shipment of the order and will not provide visibility. **Please note, parts will not be shipped overnight. Plan accordingly for transit time to reach your facility.**

**Important: Do not discard or destroy the box containing the new passenger air bag inflator, it will be needed to return the used inflator. The box contains special instructions for the packaging and shipment of the used inflator. The instructions must be followed without exception. DO NOT DEPLOY ANY INFLATOR.**

**Note: \* The new HD part numbers 84594241 (air bag kit) and 84594242 (bracket) must ONLY be submitted with the new labor code (9105607) to avoid claim rejection. Dealers submitting for the previous HD part number 84255088 must use the previous labor code (9104664) to avoid claim rejection. Vehicles repaired with old part number 84255088 OR new part number 84594241 MUST have the serial number recorded when submitting the claim.**

**Reminder:** Parts may be removed from RIM management. Dealers should review the affected parts to confirm RIM managed status.

# Product Safety Recall

## N192290990 Front Passenger Air Bag Inflator – US Only



### Special Tools

All U.S. dealers have been shipped the required air bag mounting bracket, shown below, to replace the front passenger air bag inflator module. These brackets were provided to dealers by General Motors through Bosch Automotive Service Solutions in late 2015. The Bosch tool number is EL-51377. If your dealership does not have the air bag mounting bracket, do not attempt to perform this service procedure and immediately contact Bosch at 1-800-GM-TOOLS for assistance. Attempting to replace the front passenger air bag inflator module without using the bracket poses a safety risk for the technician and anyone else in the area.

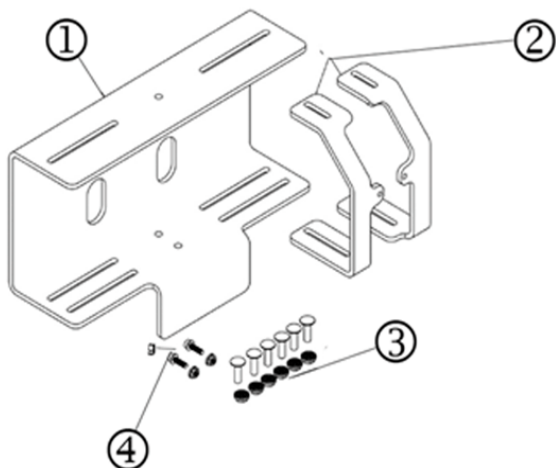

4006668

(1) Mounting Bracket (2) Support Bars (3) Support Bar Hardware (4) Air bag Mounting Hardware.

### Warranty Information

Labor Operation	Description	Labor Time	Trans. Type	Net Item
9104664	Replace Front Passenger Air Bag Inflator Module, <b>Use With Service Part 84255088 Only</b> Add: SLT Trim Level – GMC Only Add: LTZ Trim Level – Chevrolet Only	- 0.7* 0.1 0.1	ZFAT	N/A
9105607	Replace Front Passenger Air Bag Inflator Module, <b>Use With Service Part 84594241 Only</b> Add: SLT Trim Level – GMC Only Add: LTZ Trim Level – Chevrolet Only	- 0.7* 0.1 0.1		

### Serial Number Recording for All Airbag Inflator Replacements:

Labour Time [\[Top\]](#)

Labour Operation Code: \_\_\_\_\_

Module Replacement

Additional labour op code information: Serial Number:

Base Labour Time:

Set Up Time:  Additional Time:  Paint Mix Time:

Administration Time:  Diagnosis Time:

Other Labor Operation Code:  Other Labour Time:

5844317

## Product Safety Recall

### N192290990 Front Passenger Air Bag Inflator – US Only



**IMPORTANT: (TECHNICIAN and WARRANTY ADMINISTRATOR) REQUIREMENT FOR THE REPLACEMENT AIRBAG INFLATOR.** The replacement airbag inflator serial number must be captured by the technician and recorded on the job card beginning August 23, 2021. The Warranty Administrator **MUST** enter the replacement airbag inflator serial number in GWM (Global Warranty Management) or in DMS (Dealer Management System). Enter the serial number of the replacement airbag inflator in the 'Labor Operation Dependency Code' field (1) per the screen above. Failure to enter this serial number will cause the claim to reject.

- \* Submit a \$20.00 administrative allowance for return of the used front passenger air bag inflator assembly (document preparation and packaging). Add this amount in the Administrative Allowance Net Item field when submitting the repair transaction.

#### **Service Procedure For Use With Service Part Number 84255088 Only**

**Note:** Dealers are required to use the air bag mounting bracket to perform the front passenger air bag inflator module replacement procedure. If the air bag mounting bracket is not available, do not proceed with this repair.

**Warning:** Do not deploy or discard the air bag inflator module.

Remove the instrument panel passenger air bag assembly from the vehicle. Refer to *Air Bag Instrument Panel Module Replacement* in SI.

#### **SAFETY PRECAUTIONS**

**Warning:** If an air bag system is not handled using proper procedures and methods, it may be activated accidentally during work resulting in a life-threatening serious accident. If the service procedure is NOT performed correctly, the system may fail to activate when needed. Be sure to perform the proper work safely and according to the instructions in this service procedure.

1. Eliminate Static Electricity. Before start of work, touch a metallic portion of the vehicle with a bare hand to discharge static electricity charged on your body.
2. DO NOT Measure Resistance. DO NOT measure resistance of air bag components. Measuring current of a circuit tester may cause accidental activation.
3. Handle the air bag properly. If an inflator is dropped, replace it with a NEW inflator.
4. DO NOT allow foreign objects near the air bag. Collect and account for all removed nuts/bolts to prevent them from landing in the air bag assembly. Any foreign objects in the air bag assembly may cause damage or injury if the air bag is activated.
5. Wear protective equipment. Always wear appropriate protective equipment when working on the air bag.

# Product Safety Recall

## N192290990 Front Passenger Air Bag Inflator – US Only



### FRONT PASSENGER AIR BAG INFLATOR MODULE REPLACEMENT

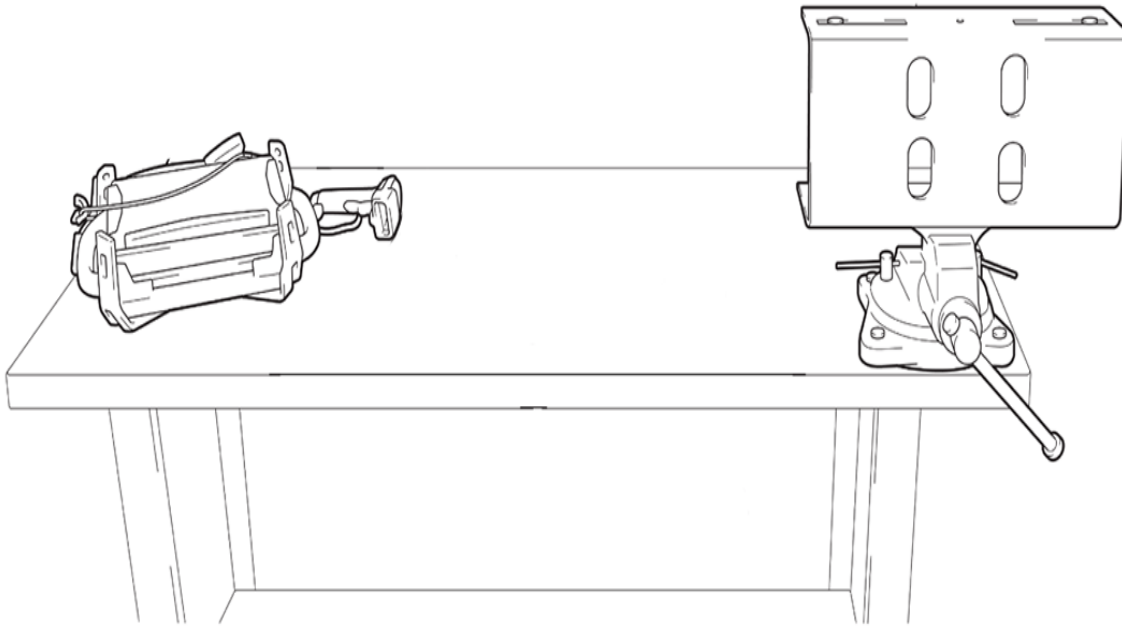

3607819

**Danger:** To avoid personal injury or death, it is critical to use an air bag module bracket when replacing an inflator module. Carefully read and follow the instructions below:

1. Confirm the bracket assembly is installed securely in the vice.
2. Confirm there are no loose objects or people exposed to the back side of the bracket for safety in the unlikely event of air bag deployment due to improper work procedures. The air bag is NOT being replaced due to an inadvertent deployment concern.
3. Confirm that no objects, tools or people are within 3 feet (1 meter) of the back side of the bracket.
4. Confirm that no objects, tools or people are within 2 feet (0.6 meters) of the sides of the bracket.
5. BEFORE starting work and periodically while working on the air bag module, touch a metallic part of the work bench to discharge static electricity in the body.

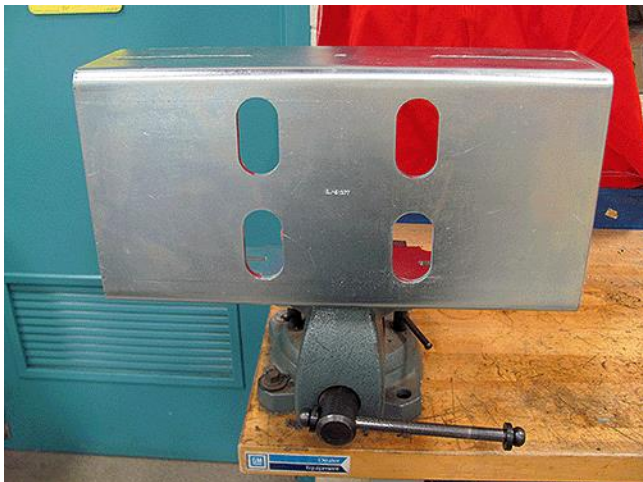

4664047

1. Mount the air bag module bracket securely in a vice.

## Product Safety Recall

### N192290990 Front Passenger Air Bag Inflator – US Only



4664048

- Using the hardware kit supplied with the module bracket, loosely mount the airbag assembly to the bracket using two nuts and bolts.

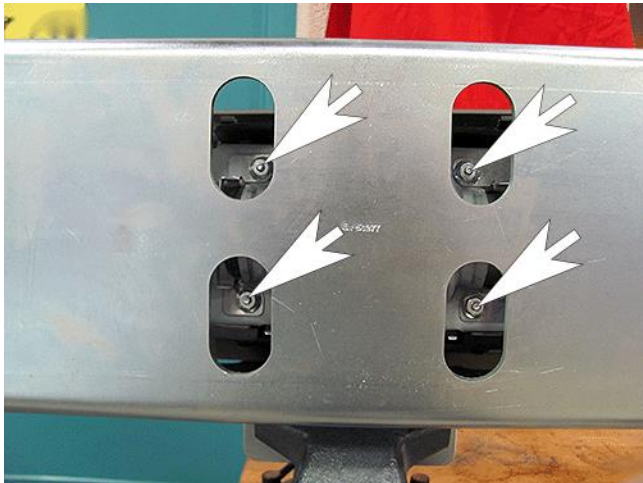

4664049

- Position the air bag so that all four stopper plate nuts can be removed through the access holes.

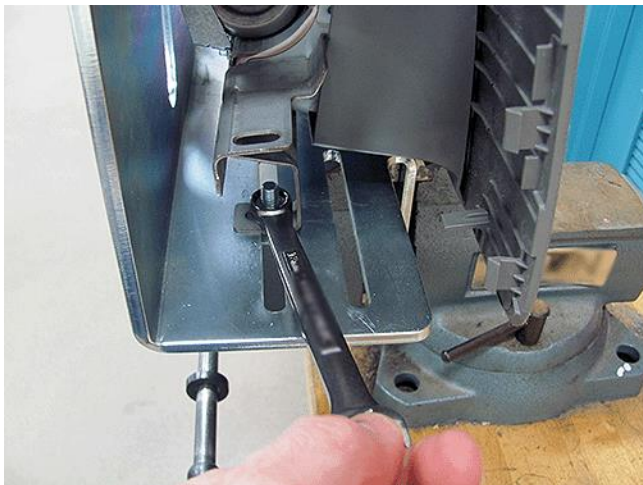

4664050

- Tighten the two fasteners that attach the airbag to the module bracket.
- Confirm the following steps have been completed BEFORE proceeding to the next step:
  - The mounting bracket is secure in the vise.

# Product Safety Recall

## N192290990 Front Passenger Air Bag Inflator – US Only



- The air bag module is secured to the bracket.



3607909

**Danger:** To avoid personal injury, *ALWAYS* keep as much of your body as possible in front of the bracket when working on the air bag assembly. Remember to periodically touch a metallic part of the vehicle or work bench to discharge static electricity in the body. **DO NOT** use power tools when performing the inflator removal/reinstallation steps.

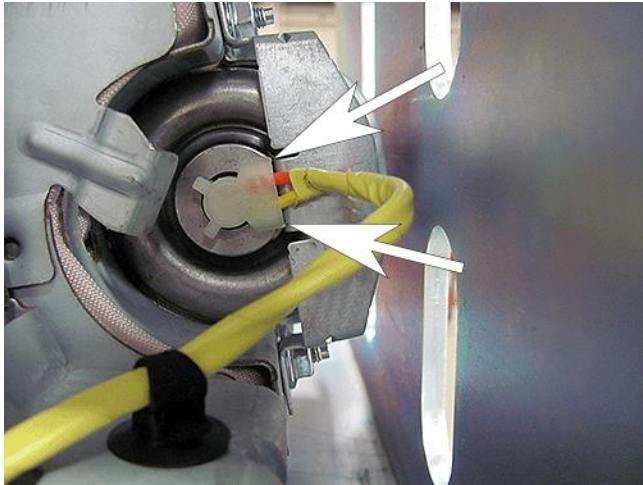

4664051

6. Note the orientation between the inflator and the stopper plate.

## Product Safety Recall

### N192290990 Front Passenger Air Bag Inflator – US Only



4664052

7. Use the access holes in the bracket to loosen and remove the four self-locking nuts. Discard the nuts, they will not be reused.
8. Remove the two stopper plates.

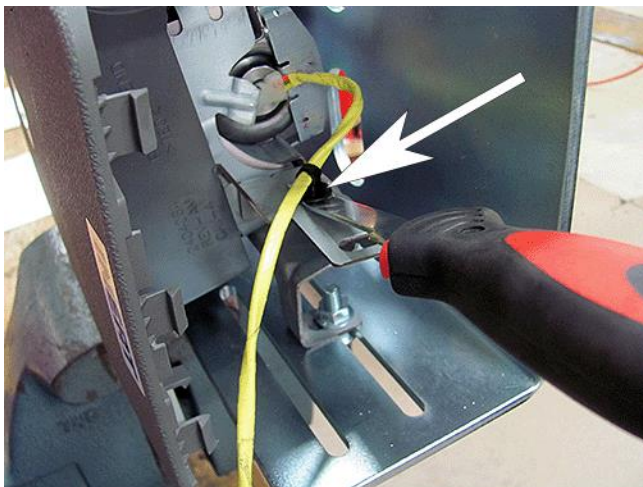

4664053

9. Disengage the wire harness locator from the housing.

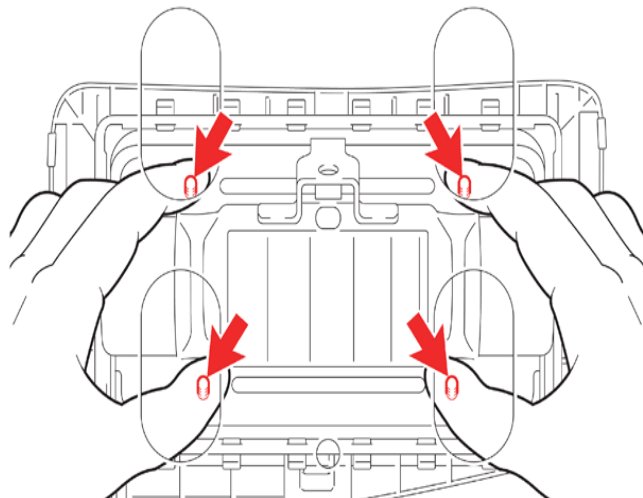

3607857

# Product Safety Recall

## N192290990 Front Passenger Air Bag Inflator – US Only



10. Gently push in the 4 studs to loosen the inflator for removal.

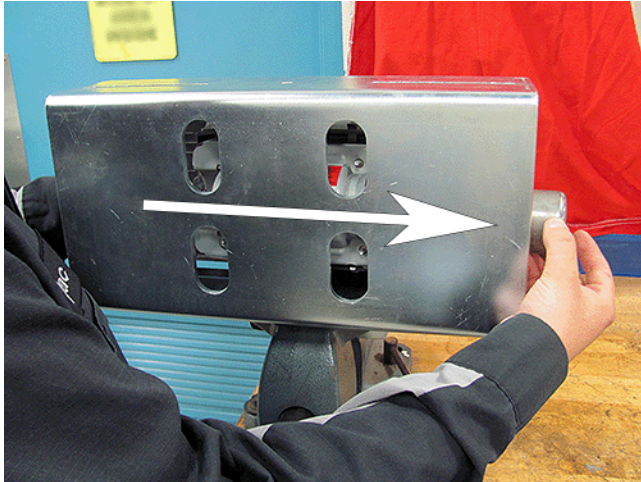

4664060

11. Remove the inflator from the housing, slide the inflator away from the harness side.



4664063

12. Put a mark on the removed inflator and store it in the provided replacement part box. Refer to the packaging instructions that were included with the new inflator module kit.



4664074

13. Record the serial number from the service inflator kit on the repair order.



## Product Safety Recall

### N192290990 Front Passenger Air Bag Inflator – US Only



4664064

14. Carefully slide the new inflator into the air bag assembly. Ensure the inflator is installed with the harness end first.



4664065

15. Confirm the identification of the stopper and the position determining plate. *THEY ARE DIFFERENT.* Refer to the illustration: (1) Stopper Plate (2) Position Determining Plate.
16. The Position determining Plate goes on the harness end, the Stopper Plate goes on the opposite end.
17. Loosely install the two plates using the 4 new nuts supplied with the inflator kit, **DO NOT TIGHTEN.**

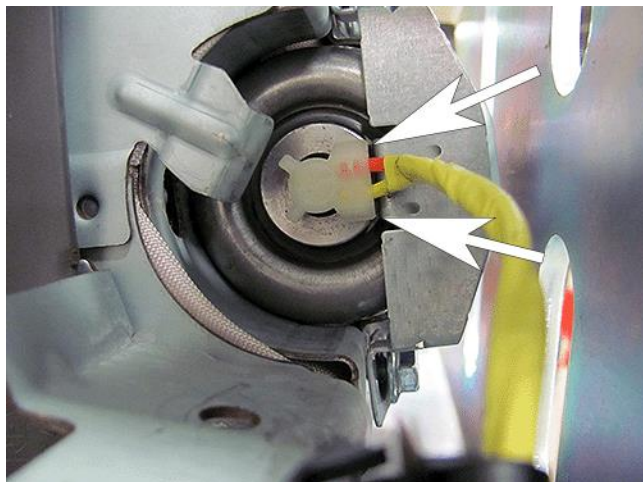

4664068

18. Rotate the inflator until the harness connector aligns with the Position Orientating Plate.

## Product Safety Recall

### N192290990 Front Passenger Air Bag Inflator – US Only



**Warning:** *DO NOT* pinch the harness between the inflator and the Position Orientating Plate.

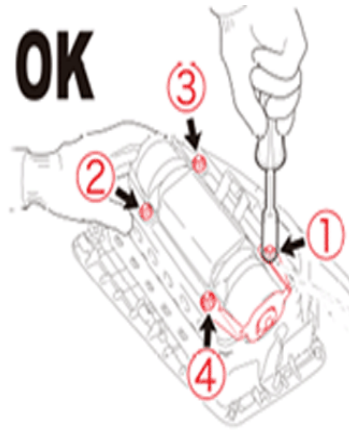
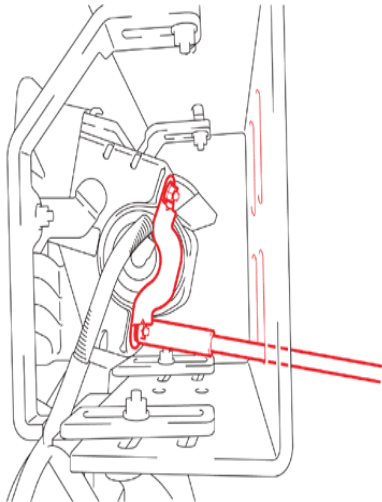

3610416

19. Tighten four (4) *NEW* plate nuts evenly in several increments in the order shown in the illustration using a 10 mm socket driver while pushing the inflator. You will encounter some resistance during tightening because these nuts are self-locking nuts. **Torque Specification: 6.5 Nm (57.53 in-lb)**

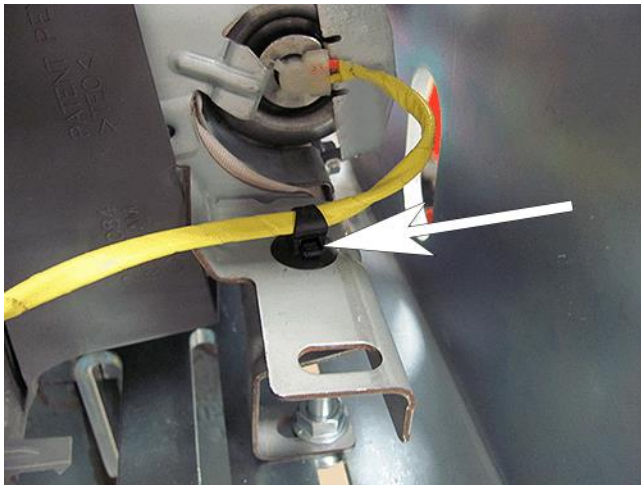

4664069

20. Install the wire harness locator to the housing.  
21. Remove the air bag assembly from the bracket by removing the two bolts and the air bag assembly.

## Product Safety Recall

### N192290990 Front Passenger Air Bag Inflator – US Only

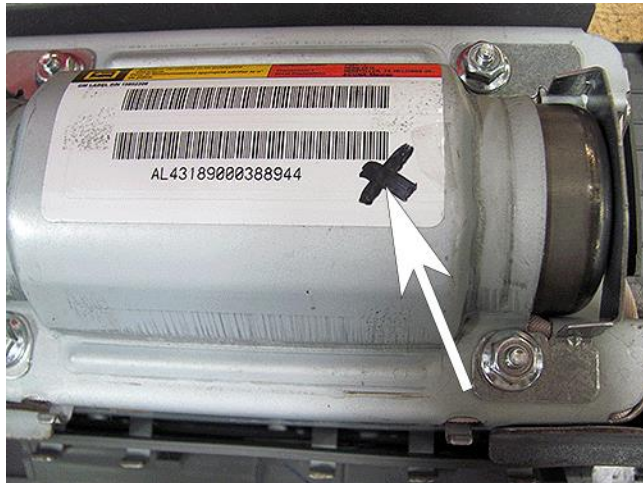

4664070

22. Mark the air bag module with an X at the right side of the ID tag.
23. Reinstall the instrument panel passenger air bag assembly. Refer to *Air Bag Instrument Panel Module Replacement* in SI.
24. The box that the new passenger air bag inflator was shipped in must be utilized to return the used inflator. The box contains special instructions for the packaging and shipment of the used inflator. The instructions must be followed without exception. If the original box is not available or you have questions about the special shipping instructions, please contact your District Service Manager- Aftersales for assistance. **DO NOT DEPLOY ANY INFLATOR.**

#### **FOR USE WITH SERVICE PART NUMBER 84594241 ONLY**

**Important:** Dealers are required to use the airbag mounting bracket to perform the front passenger airbag inflator replacement procedure. If this special tool is not available, do not proceed with this repair.

**Warning:** If an airbag system is not handled using proper procedures and methods, it may be activated accidentally during work resulting in a life-threatening serious accident. If the service procedure is not performed correctly, the system may fail to activate when needed. Be sure to perform the proper work safely and according to the instructions provided below:

1. **Eliminate Static Electricity.** Before start of work, touch a metallic portion of the vehicle with a bare hand to discharge static electricity charged on your body.
2. **DO NOT Measure Resistance.** **DO NOT** measure resistance of airbag components. Measuring current of a circuit tester may cause accidental activation.
3. **Handle the airbag properly.** If an inflator is dropped, replace it with a **NEW** inflator.
4. **DO NOT** allow foreign objects near the airbag. Collect and account for all removed nuts/bolts to prevent them from landing in the airbag assembly. Any foreign objects in the airbag assembly may cause damage or injury if the airbag is activated.
5. **Wear protective equipment.** Always wear appropriate protective equipment when working on the airbag.

Remove the instrument panel passenger airbag assembly from the vehicle and place on bench. Refer to *Airbag Instrument Panel Module Replacement* in SI.

## Product Safety Recall

### N192290990 Front Passenger Air Bag Inflator – US Only

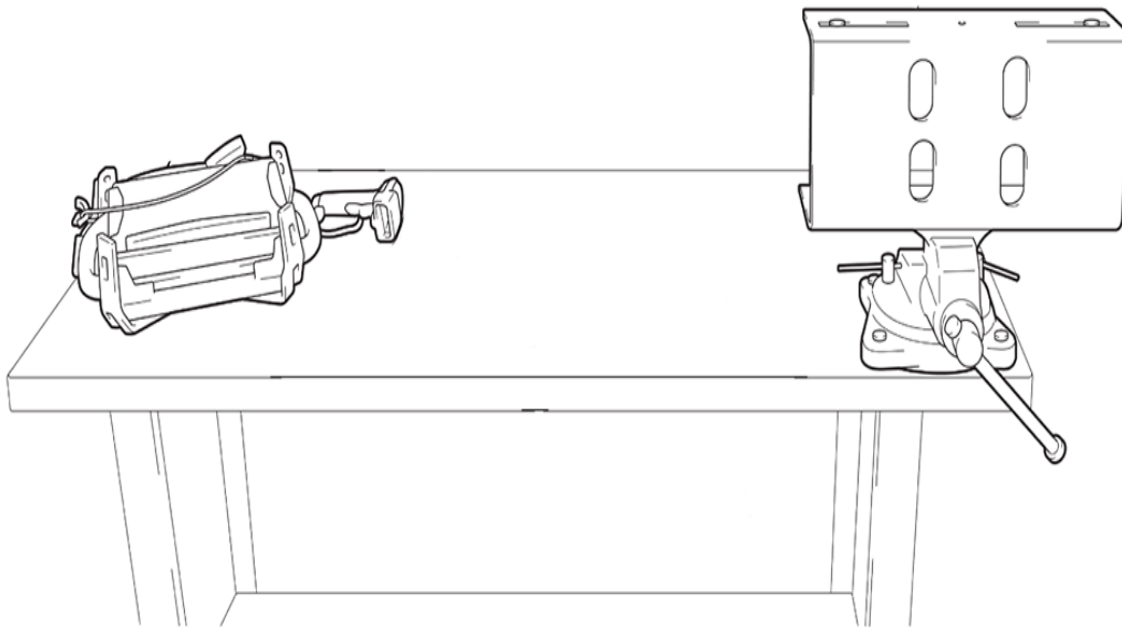

3607819

**Danger:** To avoid personal injury or death, it is critical to use an airbag module bracket when replacing an inflator module. Carefully read and follow the instructions below:

1. Confirm the bracket assembly is installed securely in the vise.
2. Confirm there are no loose objects or people exposed to the back side of the bracket for safety in the unlikely event of airbag deployment due to improper work procedures. The airbag is NOT being replaced due to an inadvertent deployment concern.
3. Confirm that no objects, tools or people are within 3 feet (1 meter) of the back side of the bracket.
4. Confirm that no objects, tools or people are within 2 feet (0.6 meters) of the sides of the bracket.
5. BEFORE starting work and periodically while working on the airbag module, touch a metallic part of the work bench to discharge static electricity in the body.

## Product Safety Recall

### N192290990 Front Passenger Air Bag Inflator – US Only

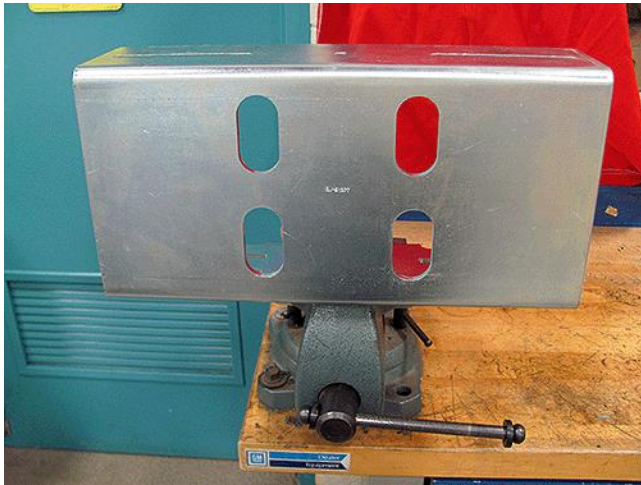

4664047

1. Mount the airbag module bracket securely in a vise.

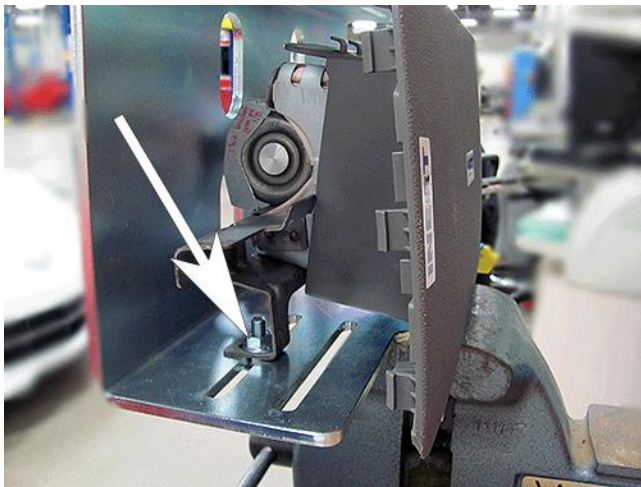

4664048

2. Using the hardware kit supplied with the module bracket, loosely mount the airbag assembly to the bracket using two nuts and bolts.

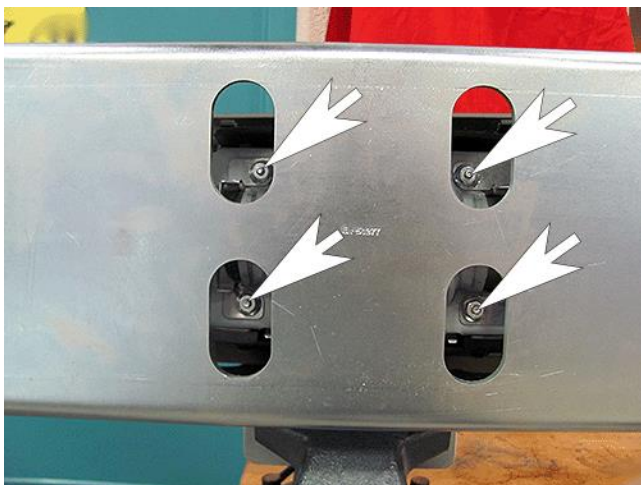

4664049

3. Position the airbag assembly so that all four stopper plate nuts can be removed through the access holes.

## Product Safety Recall

### N192290990 Front Passenger Air Bag Inflator – US Only

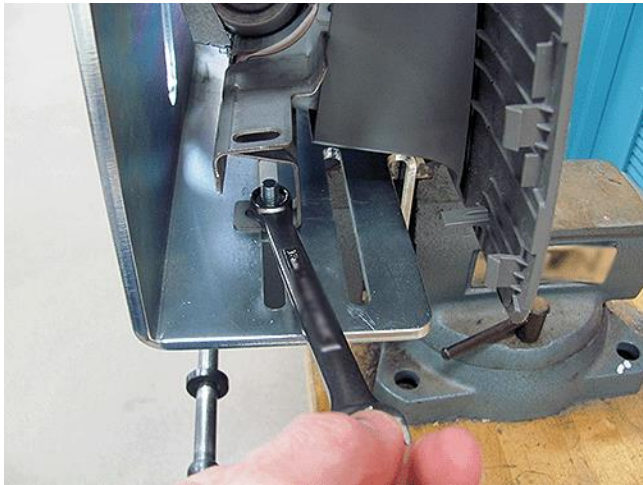

4664050

4. Tighten the two fasteners that attach the airbag assembly to the module bracket.
5. Confirm the following steps have been completed BEFORE proceeding to the next step:
  - The mounting bracket is secure in the vise.
  - The airbag assembly is secured to the bracket.



3607909

**Danger:** To avoid personal injury, *ALWAYS* keep as much of your body as possible in front of the bracket when working on the airbag assembly. Remember to periodically touch a metallic part of the vehicle or work bench to discharge static electricity in the body. **DO NOT** use power tools when performing the inflator removal/reinstallation steps.

## Product Safety Recall

### N192290990 Front Passenger Air Bag Inflator – US Only



4664052

1. Use the access holes in the bracket to loosen and remove the four self-locking nuts, **do not use power tools to remove the nuts**. Discard the nuts, they will not be reused.

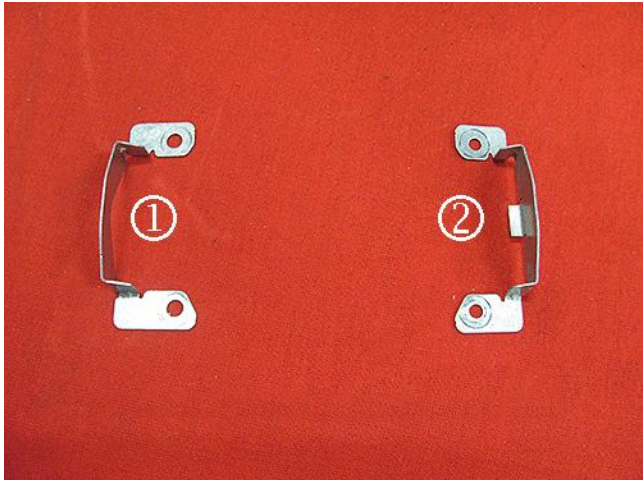

4664065

2. Remove the two stopper plates (1 and 2). Discard the stopper plates, they will not be reused.

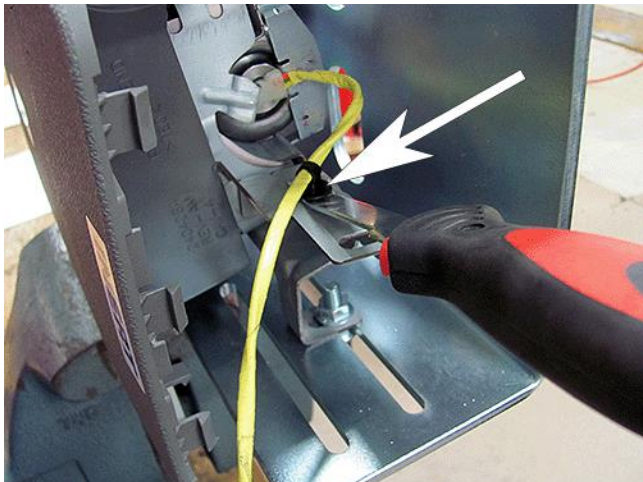

4664053

3. Disengage the wire harness locator from the housing.

# Product Safety Recall

## N192290990 Front Passenger Air Bag Inflator – US Only

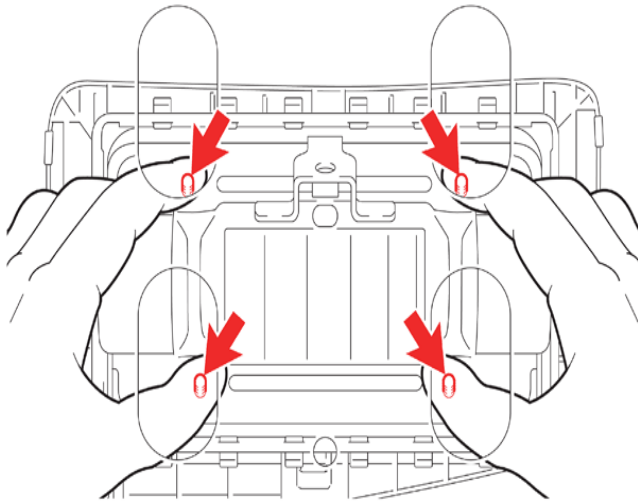

3607857

4. Gently push in the 4 studs to loosen the inflator for removal.

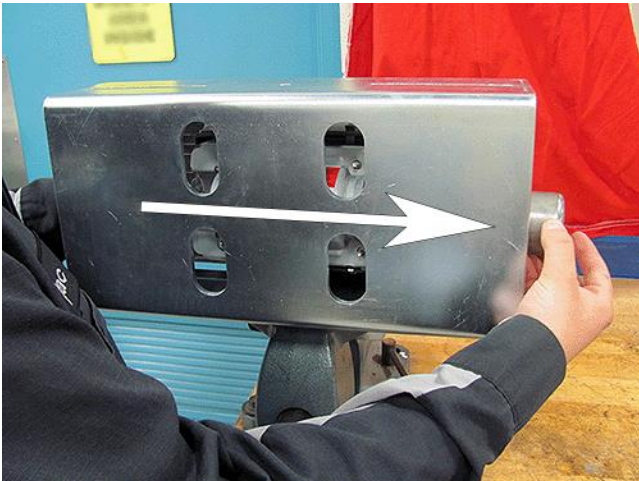

4664060

5. Remove the inflator from the housing, slide the inflator away from the harness side.



4664063

6. Put a mark on the removed inflator and store it in the replacement part box.



## Product Safety Recall

N192290990 Front Passenger Air Bag Inflator – US Only



5838265

7. Record the serial number of the new inflator from the service kit on the job card.



5844318

8. Record the serial number of the used inflator that is being returned on the job card.
9. Inspect the new inflator for the following two conditions:

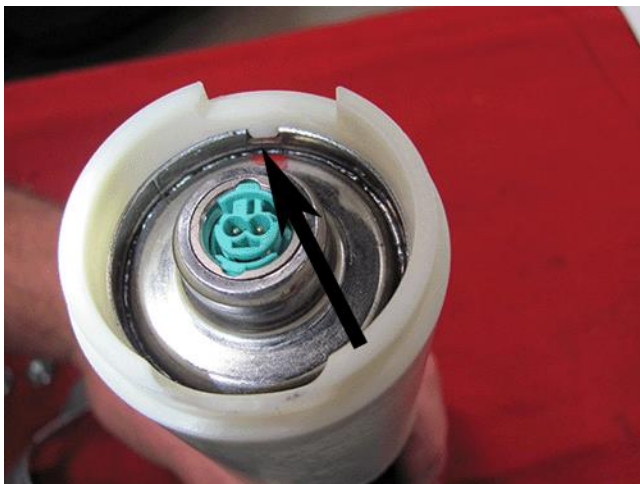

5680402

- Ensure the tab on the white end cap is aligned with the notch in the inflator.

**Product Safety Recall**  
N192290990 Front Passenger Air Bag Inflator – US Only

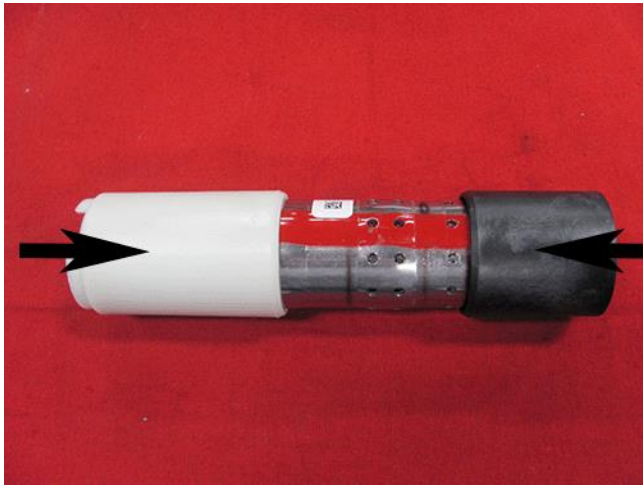

5680403

- Ensure both end caps are fully seated onto the inflator.

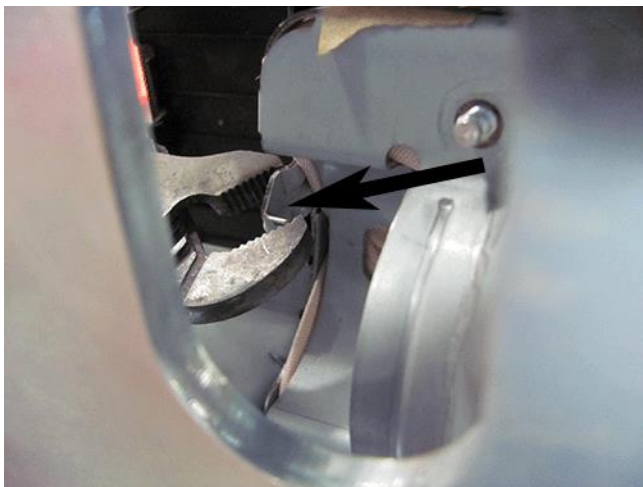

5680405



5680406

## Product Safety Recall

### N192290990 Front Passenger Air Bag Inflator – US Only

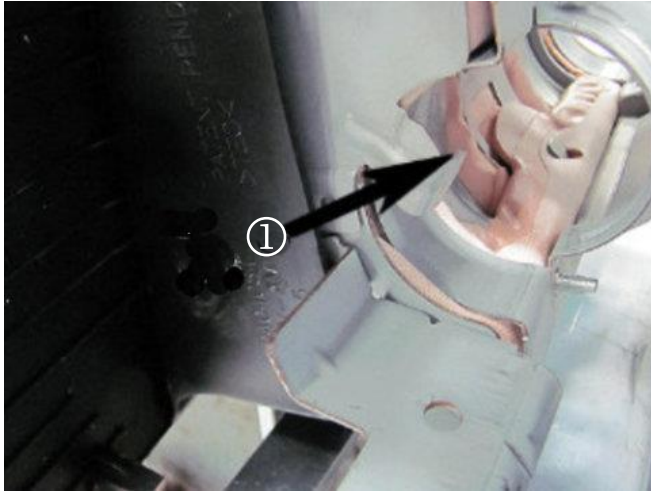

5735685

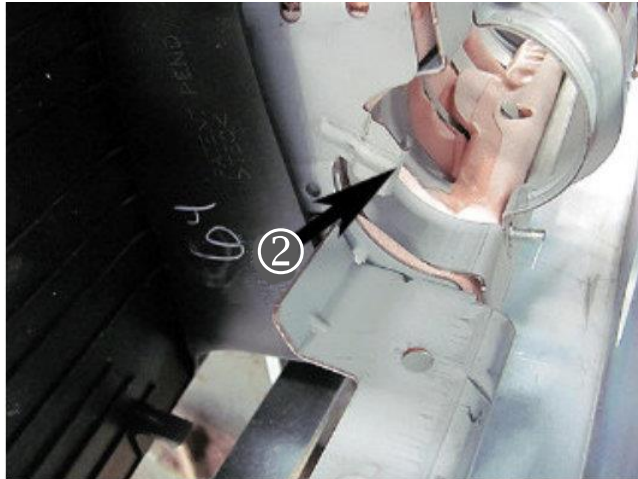

5735686

10. Using a small pair of slip joint pliers, bend the alignment tab on the airbag inward from a 90 Deg. angle (1) to a 45 Deg. angle (2).

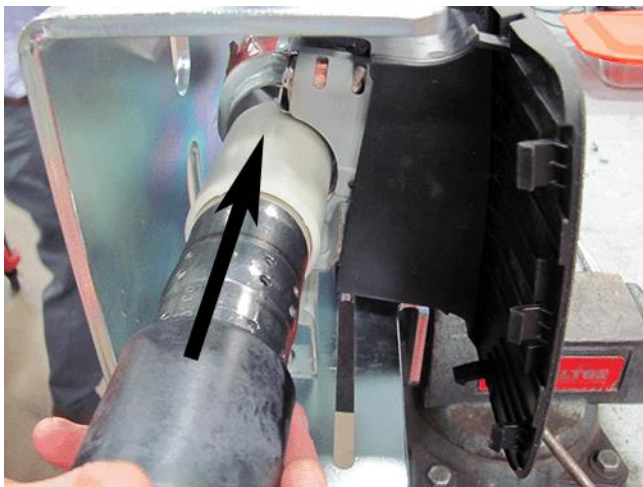

5680409

11. Carefully slide the new inflator into the airbag assembly. Ensure the inflator is installed with the harness (white end cap) end first.

## Product Safety Recall

### N192290990 Front Passenger Air Bag Inflator – US Only

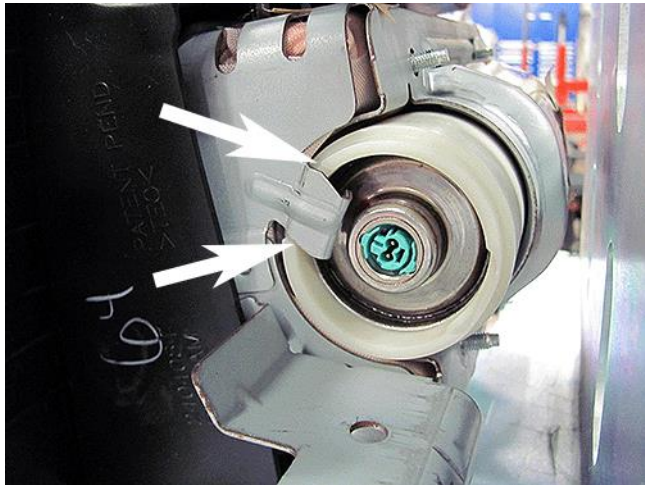

5680411

12. Rotate the inflator until the notch in the white end cap aligns with the alignment tab.

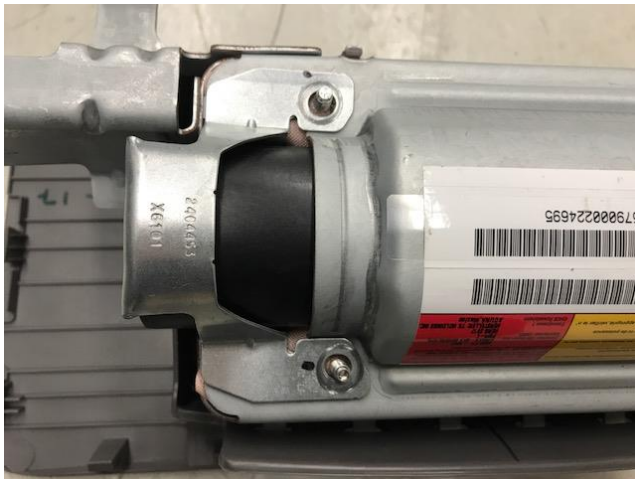

5680668

15. Place the new stopper plate (bracket) onto the studs as shown.

16. Loosely hand start the 4 new nuts onto the studs.

# Product Safety Recall

## N192290990 Front Passenger Air Bag Inflator – US Only

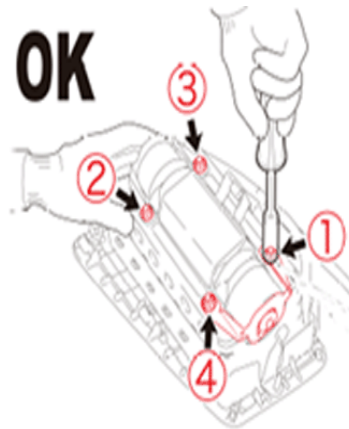
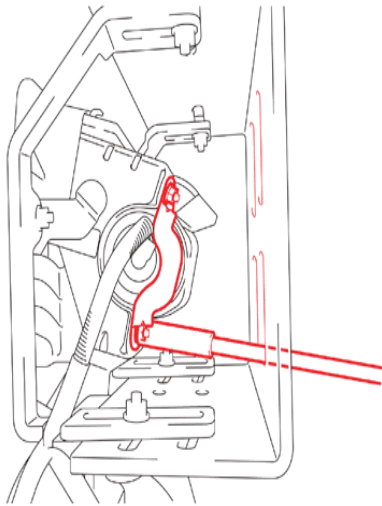

3610416

17. Tighten four (4) **NEW** plate nuts evenly in several increments in the order shown in the illustration using a 10-mm socket driver while pushing the inflator. You will encounter some resistance during tightening because these nuts are self-locking nuts. **Torque Specification: 6.5 Nm (57 in-lb).**

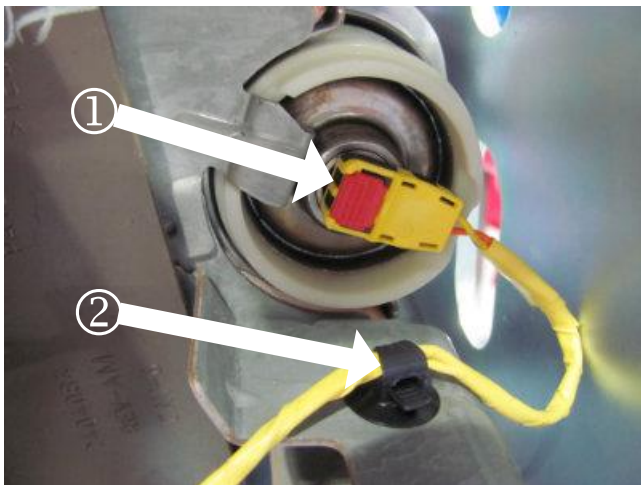

18. Connect the new yellow wiring harness to the airbag inflator, fully engage the CPA (1).
19. Install the wire harness locator to the housing (2).
20. Remove the airbag assembly from the bracket by removing the two bolts and the airbag assembly.
21. Reinstall the instrument panel passenger airbag assembly. Refer to *Airbag Instrument Panel Module Replacement* in SI.
22. The box that the new passenger air bag inflator was shipped in must be utilized to return the used inflator. The box contains special instructions for the packaging and shipment of the used inflator. The instructions must be followed without exception. If the original box is not available or you have questions about the special shipping instructions, please contact your District Service Manager- Aftersales for assistance. **DO NOT DEPLOY ANY INFLATOR.**

# Product Safety Recall

## N192290990 Front Passenger Air Bag Inflator – US Only



### Dealer Responsibility – For USA (USA States, Territories, and Possessions)

It is a violation of Federal law for a dealer to deliver a new motor vehicle or any new or used item of motor vehicle equipment (including a tire) covered by this notification under a sale or lease until the defect or noncompliance is remedied.

The US National Traffic and Motor Vehicle Safety Act provides that each vehicle that is subject to a recall of this type must be adequately repaired within a reasonable time after the customer has tendered it for repair. A failure to repair within sixty days after tender of a vehicle is prima facie evidence of failure to repair within a reasonable time. If the condition is not adequately repaired within a reasonable time, the customer may be entitled to an identical or reasonably equivalent vehicle at no charge or to a refund of the purchase price less a reasonable allowance for depreciation. To avoid having to provide these burdensome remedies, every effort must be made to promptly schedule an appointment with each customer and to repair their vehicle as soon as possible. In the recall notification letters, customers are told how to contact the US National Highway Traffic Safety Administration if the recall is not completed within a reasonable time.

### Dealer Responsibility – All

All new, used, GM Certified Used, courtesy transportation vehicles, dealer shuttle vehicles, etc. in dealers' possession and subject to this recall must be held and inspected/repaired per the service procedure of this bulletin before customers take possession of these vehicles. Involved vehicles must be held and not delivered to customers, dealer-traded, released to auction, used for demonstration, or any other purpose.

All GM Certified Used vehicles currently in the dealers' inventory within the Certified Pre-Owned Inventory System (CPOIS) will be de-certified and must be held and remedied per the service procedure in this bulletin. Upon submitting an accepted/paid warranty transaction in the Global Warranty Management (GWM) system, the vehicle can be re-certified for sale within the CPOIS system, or once again be used in the CTP program.

Dealers are to service all vehicles subject to this recall at no charge to customers, regardless of mileage, age of vehicle, or ownership, from this time forward.

Customers who have recently purchased vehicles sold from your vehicle inventory, and for which there is no customer information indicated on the dealer listing, are to be contacted by the dealer. Arrangements are to be made to make the required correction according to the instructions contained in this bulletin. A copy of the customer letter is provided in this bulletin for your use in contacting customers. Recall follow-up cards should not be used for this purpose, since the customer may not as yet have received the notification letter.

In summary, whenever a vehicle subject to this field action enters your vehicle inventory you must take the steps necessary to ensure the program correction has been made before selling the vehicle. In addition, for vehicles entering your facility for service, you are required to ensure the customer is aware of the open field action and make every reasonable effort to implement the program correction as set forth in this bulletin prior to releasing the vehicle.

### Dealer Reports

For dealers with involved vehicles, a listing with involved vehicles has been prepared and will be provided to U.S. and Canadian dealers through the GM GlobalConnect Recall Reports or sent directly to export dealers. The listing may contain customer names and addresses obtained from Motor Vehicle Registration Records. The use of such motor vehicle registration data for any purpose other than follow-up necessary to complete this recall is a violation of law in several states/provinces/countries. Accordingly, you are urged to limit the use of this report to the follow-up necessary to complete this recall.

### Customer Notification

USA - General Motors will notify customers of this recall on their vehicle (see copy of customer letter included with this bulletin).

---

GM bulletins are intended for use by professional technicians, NOT a "do-it-yourselfer". They are written to inform these technicians of conditions that may occur on some vehicles, or to provide information that could assist in the proper service of a vehicle. Properly trained technicians have the tools, equipment, safety instructions, and know-how to do a job properly and safely. If a condition is described, **DO NOT** assume that the bulletin applies to your vehicle, or that your vehicle will have that condition. See your dealer for information on whether your vehicle may benefit from the information.



**We Support  
Voluntary Technician  
Certification**

# Product Safety Recall

## N192290990 Front Passenger Air Bag Inflator – US Only



# IMPORTANT SAFETY RECALL

February 2020

This notice applies to your vehicle, VIN: \_\_\_\_\_

Dear General Motors Customer:

This notice is sent to you in accordance with the National Traffic and Motor Vehicle Safety Act.

TK Global LLC (“Takata”) has decided that a defect which relates to motor vehicle safety exists in certain 2007-2008 model year Chevrolet Silverado and GMC Sierra 2500/3500 series heavy duty pickup trucks. As a result, GM is conducting a safety recall. We apologize for this inconvenience. However, we are concerned about your safety and continued satisfaction with our products.

<p><b>IMPORTANT</b></p> <ul style="list-style-type: none"> <li>Your vehicle is involved in GM safety recall N192290990.</li> <li>Schedule an appointment with your GM dealer.</li> <li>This service will be performed for you at <b>no charge</b>.</li> </ul>
---

**Why is your vehicle being recalled?**

Takata has determined that some of the front passenger air bag inflators in these vehicles may experience an alteration over time, which could lead to overaggressive combustion in the event of an air bag deployment. This condition could create excessive internal pressure when the air bag is deployed, which could result in the body of the inflator rupturing upon deployment. In the event of an inflator rupture, metal fragments could pass through the air bag cushion material, which may result in injury or death to vehicle occupants.

**What will we do?**

Your GM will replace the front passenger air bag inflator module. This service will be performed for you at **no charge**. Because of service scheduling requirements, it is likely that your dealer will need your vehicle longer than the actual service correction time of approximately one hour.

**What should you do?**

You should contact your GM dealer to arrange a service appointment as soon as possible.

**Do you have questions?**

If you have questions or concerns that your dealer is unable to resolve, please contact the appropriate Customer Assistance Center at the number listed below.

Division	Number	Text Telephones (TTY)
Chevrolet	1-800-630-2438	1-800-833-2438
GMC	1-866-996-9463	1-800-462-8583
Puerto Rico – English	1-800-496-9992	
Puerto Rico – Español	1-800-496-9993	
Virgin Islands	1-800-496-9994	

If after contacting your dealer and the Customer Assistance Center, you are still not satisfied we have done our best to remedy this condition without charge and within a reasonable time, you may wish to write the Administrator, National Highway Traffic Safety Administration, 1200 New Jersey Avenue, SE, Washington, DC 20590, or call the toll-free Vehicle Safety Hotline at 1.888.327.4236 (TTY 1.800.424.9153), or go to <http://www.safercar.gov>. The National Highway Traffic Safety Administration Campaign ID Number for this recall is 20V011.

Federal regulation requires that any vehicle lessor receiving this recall notice must forward a copy of this notice to the lessee within ten days.

Maryann L. Combs  
Vice President  
Global Vehicle Safety