



# Safety Recall

## Code: 72K8

# REVISION

**Subject** Front Seat Backrest Frame Welds

**Release Date** November 14, 2020

**REVISION SUMMARY** Updated vehicle counts for USA only and added criteria 11 to the claiming instructions.

**Affected Vehicles**

Country	Beginning Model Year	Ending Model Year	Vehicle	Vehicle Count
USA	2021	2021	ATLAS	1,487
USA	2020	2020	ATLAS CROSS SPORT	1,006
CAN	2021	2021	ATLAS	404
CAN	2020	2020	ATLAS CROSS SPORT	171

Check Campaigns/Actions screen in ELSA on the day of repair to verify that a VIN qualifies for repair under this action. ELSA is the only valid campaign inquiry & verification source.

- ✓ Campaign status must show "open."
- ✓ If ELSA shows other open action(s), inform your customer so that the work can also be completed at the same time the vehicle is in the workshop for this campaign.

**Problem Description**

Individual parts of the front seat backrest adjusting mechanism and the side element of the front seat backrest frame may not have been welded properly. In the event of a rear-end crash, the backrest adjustment could break under unfavorable conditions and the intended restraint effect may no longer be achieved. This may cause an increased risk of injury to the occupant of the front seat and potentially to the occupant in the rear seat directly behind it.

**Corrective Action**

Inspect the front driver and passenger seats. If an affected part is found, the seatback frame will be replaced.

**Code Visibility**

On or about September 4, 2020, the campaign code was applied to affected vehicles.

**Owner Notification**

Owner notification took place in September, 2020. Owner letter examples are included in this bulletin for your reference.

**Additional Information**

Please alert everyone in your dealership about this action, including Sales, Service, Parts and Accounting personnel. Contact Warranty if you have any questions.

**IMPORTANT REMINDER ON VEHICLES AFFECTED BY SAFETY & COMPLIANCE RECALL:**

**New Vehicles in Dealer Inventory: It is a violation of federal law for a dealer to deliver a new motor vehicle or any new or used item of motor vehicle equipment (including a tire) covered by this notification under a sale or lease until the defect or noncompliance is remedied. By law, dealers must correct, prior to delivery for sale or lease, any vehicle**

The repair information in this document is intended for use only by skilled technicians who have the proper tools, equipment and training to correctly and safely maintain your vehicle. These procedures are not intended to be attempted by "do-it-yourselfers," and you should not assume this document applies to your vehicle, or that your vehicle has the condition described. To determine whether this information applies, contact an authorized Volkswagen dealer. ©2020 Volkswagen Group of America, Inc. and Volkswagen Canada. All Rights Reserved.

that fails to comply with an applicable Federal Motor Vehicle Safety Standard or that contains a defect relating to motor vehicle safety.

**Pre-Owned Vehicles in Dealer Inventory: Dealers should not deliver any pre-owned vehicles in their inventory which are involved in a safety or compliance recall until the defect has been remedied.**

Dealers must ensure that every affected inventory vehicle has this campaign completed before delivery to consumers.

Fill out and affix Campaign Completion Label (CAMP 010 000) after work is complete. *Labels can be ordered at no cost via the Compliance Label Ordering portal at [www.vwhub.com](http://www.vwhub.com).*

## Parts Information

**Parts Control Type:**  
**VIN to Order**

If a backrest frame is needed to support a vehicle repair:

- US Dealers - use AVA
- CAN Dealers - contact the Parts Specialists via phone (800-767-6552), email (VWoAPartsSpecialists@vw.com), or chat/text with the VIN to order

**Parts Control Type:**  
**Free Order**

Parts will be managed by Free Order (all other parts)

**Initial Allocation:**  
**NO**

Due to the small number of affected vehicles there will be no parts allocation.

Criteria	Quantity	Part Number	P.O.C. Part Description	Ordering Method
01	As needed	SEE ETKA	Front seat backrest frame	VIN to Order
	Up to 2	N -907-912-01	Bolt (seat airbag - if necessary)	Free Order
	Up to 8	WHT-002-796-B	Screw (backrest frame to seat pan)	Free Order

**NOTE**

The specified part numbers reflect the status at the start of this service action. Interim updates made in ETKA can cause a listed part number to become unavailable. In this case, the new part number specified in ETKA should be used.

## Claim Entry Instructions

The labor times listed here may differ from the labor operations and labor times listed in ELSA.

After campaign has been completed, enter claim as soon as possible to help prevent work from being duplicated elsewhere. Attach the ELSA screen print showing action open on the day of repair to the repair order.

If customer refused campaign work:

- ✓ U.S. dealers: Submit request via WISE under the *Campaigns/Update/Recall Closure* option.
- ✓ Canada dealers: Upload the repair order [signed by customer] to Volkswagen WIN/Operations/Campaign Closure.

<b>Service Number</b>	72K8		
<b>Damage Code</b>	0099		
<b>Parts Vendor Code</b>	WWO		
<b>Claim Type</b>	Sold vehicle: 7 10 Unsold vehicle: 7 90		
<b>Causal Indicator</b>	Mark labor as causal unless the backrest(s) require replacement, then mark one backrest* as causal		
<b>Vehicle Wash/Loaner</b>	Do not claim wash/loaner under this action  <b>U.S.A.:</b> Loaner/rental coverage cannot be claimed under this action. However, loaner/rental may be covered under the Alternate Transportation Program. Please refer to the Volkswagen Warranty Policy and Procedures Manual for loaner claims information and reimbursement details.  <b>Canada:</b> Loaner/rental coverage cannot be claimed under this action. Please refer to Volkswagen Service Loaner Program to determine loaner eligibility.		
<b>Criteria I.D.</b>	01 or 11		
	Inspect left front and right front backrests, both backrests are ok, no further work necessary.		
	<b>LABOR</b>		
	<b>Labor Op</b>	<b>Time Units</b>	<b>Description</b>
	0183 00 99	50	Inspect front seat backrests, no replacement needed

Continued on next page

<b>OR</b>	Inspect left front and right front backrests, left OR right backrest frame requires replacement		
	<b>LABOR</b>		
	<b>Labor Op</b>	<b>Time Units</b>	<b>Description</b>
	7219 55 99	250	Inspect front seat backrests, replace left OR right backrest frame
	<b>PARTS</b>		
	<b>Quantity</b>	<b>Part Number</b>	<b>Description</b>
	1.00	SEE ETKA	Left or Right Backrest Frame*
	1.00	N 90791201	Oval Hexagon Socket Head Bolt (if needed)
	4.00	WHT002796B	Cylinder Head Screw With Torx Head
<b>OR</b>	Inspect left front and right front backrests, both backrest frames require replacement		
	<b>LABOR</b>		
	<b>Labor Op</b>	<b>Time Units</b>	<b>Description</b>
	7219 56 99	440	Inspect front seat backrests, replace both backrest frames
	<b>PARTS</b>		
	<b>Quantity</b>	<b>Part Number</b>	<b>Description</b>
	1.00	SEE ETKA	Left Backrest Frame *
	1.00	SEE ETKA	Right Backrest Frame
	2.00	N 90791201	Oval Hexagon Socket Head Bolt (if needed)
8.00	WHT002796B	Cylinder Head Screw With Torx Head	

The repair information in this document is intended for use only by skilled technicians who have the proper tools, equipment and training to correctly and safely maintain your vehicle. These procedures are not intended to be attempted by "do-it-yourselfers," and you should not assume this document applies to your vehicle, or that your vehicle has the condition described. To determine whether this information applies, contact an authorized Volkswagen dealer. ©2020 Volkswagen Group of America, Inc. and Volkswagen Canada. All Rights Reserved.

## Customer Letter Example (USA)

<MONTH YEAR>

<CUSTOMER NAME>

<CUSTOMER ADDRESS>

<CUSTOMER CITY STATE ZIPCODE>

**This notice applies to your vehicle:** <MODEL YEAR> <BRAND> <CARLINE>, <VIN>

**NHTSA:** 20V505

**Subject: Safety Recall 72K8 - Front Seat Backrest Frame Welds**

Dear Volkswagen Owner,

This notice is sent to you in accordance with the National Traffic and Motor Vehicle Safety Act. Volkswagen has decided that a defect, which relates to motor vehicle safety, exists in certain 2020-2021 model year Volkswagen vehicles. Our records show that you are the owner of a vehicle affected by this action.

<b>What is the issue?</b>	Individual parts of the front seat backrest adjusting mechanism and the side element of the front seat backrest frame may not have been welded properly. In the event of a rear-end crash, the backrest adjustment could break under unfavorable conditions and the intended restraint effect may no longer be achieved. This may cause an increased risk of injury to the occupant of the front seat and potentially to the occupant in the rear seat directly behind it.
<b>What will we do?</b>	<p>To identify/correct this defect, your authorized Volkswagen dealer will inspect the front driver and passenger seats. The inspection will take about a half an hour to complete.</p> <p>If an affected part is found, the seatback frame will be replaced. In that case, your dealer will order the part(s) needed for the repair. Once the part(s) arrives at your dealer, the replacement will take up to a half a day to complete.</p> <p>Both the inspection and part(s) replacement (if needed) will be performed for you free of charge. Please keep in mind that your dealer may need additional time for the preparation of the repair, as well as to accommodate their daily workshop schedule.</p>
<b>What should you do?</b>	Please contact your authorized Volkswagen dealer without delay to schedule this recall repair. To set up an appointment online, please visit <a href="http://www.vw.com/find-a-dealer">www.vw.com/find-a-dealer</a> .
<b>Lease vehicles and address changes</b>	If you are the lessor and registered owner of the vehicle identified in this action, the law requires you to forward this letter immediately via first-class mail to the lessee within ten (10) days of receipt. If you have changed your address or sold the vehicle, please fill out the enclosed prepaid Owner Reply card and mail it to us so we can update our records.
<b>Can we assist you further?</b>	If your authorized Volkswagen dealer fails or is unable to complete this work free of charge within a reasonable time, or if you should have any questions about this communication, please reach out to us using your preferred method of communication at <a href="http://www.vw.com/contact">www.vw.com/contact</a> or by calling us at 800-893-5298.
<b>Checking your vehicle for open Recalls and Service Campaigns</b>	To check your vehicle's eligibility for repair under this or any other recall/service campaign, please visit <a href="http://www.vw.com/owners/recalls">www.vw.com/owners/recalls</a> and enter your Vehicle Identification Number (VIN) into the Recall/Service Campaign Lookup tool.

If you still cannot obtain satisfaction, you may file a complaint with: The Administrator, National Highway Traffic Safety Administration, 1200 New Jersey Avenue, SE., Washington, DC 20590; or call the toll-free Vehicle Safety Hotline at 1-888-327-4236 (TTY: 1-800-424-9153); or go to <http://www.safercar.gov>.

We apologize for any inconvenience this matter may cause; however we are taking this action to help ensure your safety and continued satisfaction with your vehicle.

Sincerely,

Volkswagen Customer Protection

The repair information in this document is intended for use only by skilled technicians who have the proper tools, equipment and training to correctly and safely maintain your vehicle. These procedures are not intended to be attempted by "do-it-yourselfers," and you should not assume this document applies to your vehicle, or that your vehicle has the condition described. To determine whether this information applies, contact an authorized Volkswagen dealer. ©2020 Volkswagen Group of America, Inc. and Volkswagen Canada. All Rights Reserved.

## Customer Letter Example (Canada)

<MONTH YEAR>

<CUSTOMER NAME>

<CUSTOMER ADDRESS>

<CUSTOMER CITY STATE ZIPCODE>

**This notice applies to your vehicle:** <MODEL YEAR> <BRAND> <CARLINE>, <VIN>

**Transport Canada Recall:** 2020-392

**Subject: Safety Recall 72K8 - Front Seat Backrest Frame Welds**

Dear Volkswagen Owner,

This notice is sent to you in accordance with the requirements of the *Motor Vehicle Safety Act*. This is to inform you that your vehicle may contain a defect that could affect the safety of a person. Our records show that you are the owner of a vehicle affected by this action.

**What is the issue?**

Individual parts of the front seat backrest adjusting mechanism and the side element of the front seat backrest frame may not have been welded properly. In the event of a rear-end crash, the backrest adjustment could break under unfavorable conditions and the intended restraint effect may no longer be achieved. This may cause an increased risk of injury to the occupant of the front seat and potentially to the occupant in the rear seat directly behind it.

**What will we do?**

To identify/correct this defect, your authorized Volkswagen dealer will inspect the front driver and passenger seats. The inspection will take about a half an hour to complete.

If an affected part is found, the seatback frame will be replaced. In that case, your dealer will order the part(s) needed for the repair. Once the part(s) arrives at your dealer, the replacement will take up to half a day to complete.

Both the inspection and part(s) replacement (if needed) will be performed for you free of charge. Please keep in mind that your dealer may need additional time for the preparation of the repair, as well as to accommodate their daily workshop schedule.

**What should you do?**

Please contact your authorized Volkswagen dealer without delay to schedule this recall repair.

**Lease vehicles and address changes**

If you are the lessor and registered owner of the vehicle identified in this letter, you shall forward this letter (and any subsequent notice, if applicable) to the lessee within ten (10) days of receipt. If you have changed your address or sold the vehicle identified in this letter, please fill out the enclosed prepaid Owner Reply Card and mail it to us so we can update our records.

**Can we assist you further?**

If your authorized Volkswagen dealer fails or is unable to complete this work free of charge within a reasonable time, please contact Customer Relations, Monday through Friday from 8AM to 8PM EST by phone at 1-800-822-8987 or via our "Contact Us" page at [www.vw.ca](http://www.vw.ca).

We apologize for any inconvenience this matter may cause; however we are taking this action to help ensure your safety and continued satisfaction with your vehicle.

Sincerely,

Volkswagen Customer Protection

## Repair Overview

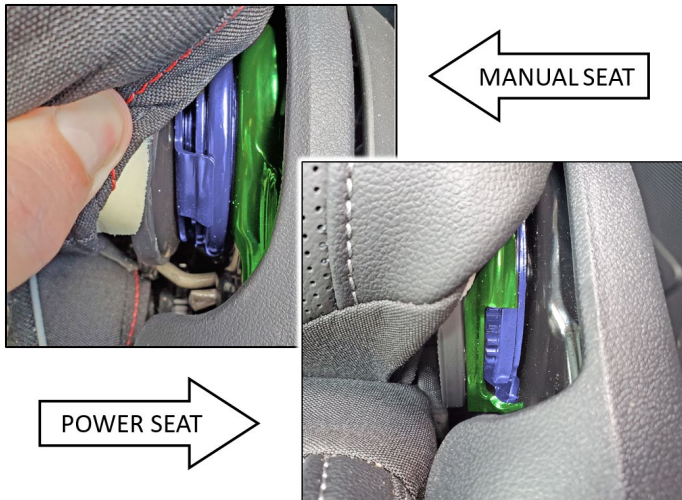

- Inspect left front and right front seat recliner mechanism on both front seats.
- Replace seat frame if necessary.

### NOTE

- These repair instructions may differ from the labor operations and labor times listed in ELSA.
- Damages resulting from improper repair or failure to follow these work instructions are the dealer's responsibility and are not eligible for reimbursement under this action.
- This procedure must be read in its entirety prior to performing the repair.
- Due to variations in vehicle equipment and options, the steps/illustrations in this work procedure may not identically match all affected vehicles.
- Diagnosis and repair of pre-existing conditions in the vehicle are not covered under this action.
- When working during extreme temperatures, it is recommended that the vehicle be allowed to acclimate inside the shop to avoid temperature-related component damage/breakage.

## Required Tools



Feeler Gauge  
(locally sourced)





## Repair Instruction

### Section A - Check for Previous Repair

#### TIP

If Campaign Completion label is present, no further work is required.

Applicable criteria ID(s)	Campaign/Action Status
01 	Open 

**EXAMPLE**

Campaign/Action	Start	Designation
	2015-11-10	W-SERV_ACT -
	2018-12-13	RECALL -
	2017-05-16	A-RECALL -

**EXAMPLE**

- Enter the VIN in Elsa and proceed to the “Campaign/Action” screen.

#### TIP

On the date of repair, print this screen and keep a copy with the repair order.

- Confirm the Campaign/Action is open <arrow 1>. If the status is closed, no further work is required.
- Note the Applicable Criteria ID <arrow 2> for use in determining the correct work to be done and corresponding parts associated.

#### **CRITICAL REPAIR STEP**



If multiple software update Campaign/Actions are open, they must be performed in order of the Start date <arrow 3>. The oldest should be performed first.

- **All Safety Recalls must be completed prior to completing this campaign.**
- **Proceed to Section B.**

### Section B – Inspecting Seat Frames

- **The inboard and outboard recline mechanisms must be inspected on both front seats.**
- **The inspection must be done with the seats fully reclined and with the seats in the fully upright position.**
- Vehicles with power recline seats – Proceed to Sub-section 1.
- Vehicles with manual recline seats – Proceed to Sub-section 2.

The repair information in this document is intended for use only by skilled technicians who have the proper tools, equipment and training to correctly and safely maintain your vehicle. These procedures are not intended to be attempted by “do-it-yourselfers,” and you should not assume this document applies to your vehicle, or that your vehicle has the condition described. To determine whether this information applies, contact an authorized Volkswagen dealer. ©2020 Volkswagen Group of America, Inc. and Volkswagen Canada. All Rights Reserved.

## Sub-section 1 – Inspecting Seat Frames – Power Recline Seats

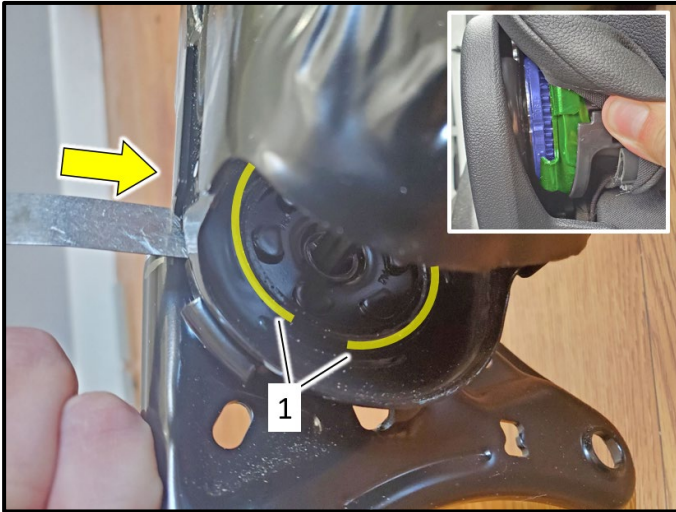

- When using the 0.5 mm feeler gauge in the following steps, you are not checking the width of the gap; the feeler gauge will act as a probe.
- When inserting the feeler gauge, push the gauge in between the components in the direction of <arrow>. You are checking to see if the gauge passes by the laser welds <1>.

### ! NOTE

Power backrest shown in the full upright position. The process for both sides on both front seats, in the upright and reclined position is similar. The welds for the power backrest are not exposed.



- Fully recline left front and right front seats.

Outboard Recline Mechanism (closest to the door):

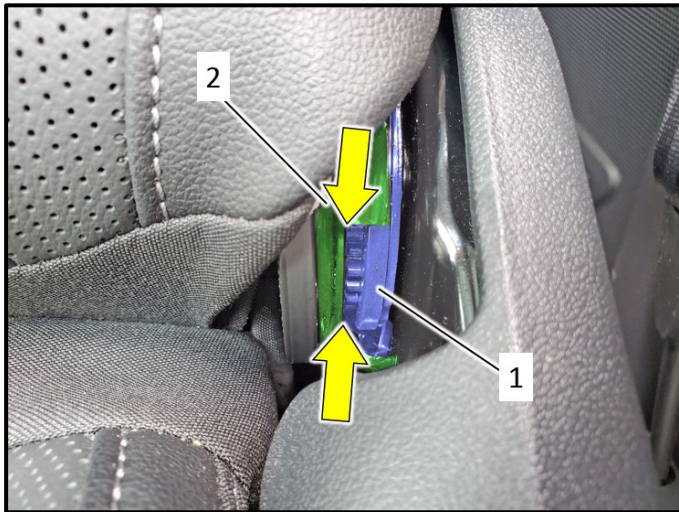

Inboard Recline Mechanism (closest to the center tunnel):

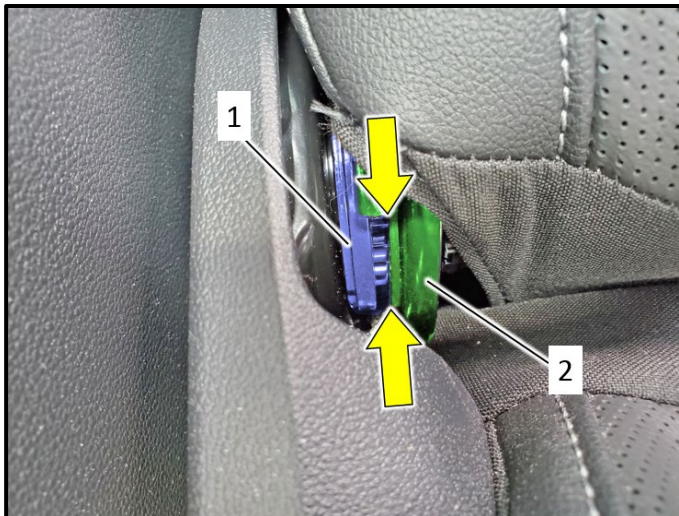

**PERFORM THE INSPECTION ON BOTH RECLINE MECHANISMS ON BOTH FRONT SEATS.**

- Pull back the seat covering to expose the recline mechanism.
- Inspect the gap between recline mechanism <1> and mounting bracket <2> in the area shown <between arrows> using the 0.5 mm gauge.
- You will be checking for the presence of a complete weld between recline mechanism <1> and backrest frame <2>.
- If the 0.5 mm gauge can be fully inserted between the components:
  - The seat frame must be replaced.

**⚠ WARNING**

IF THE BACKREST FRAME IS BEING REPLACED, THE VEHICLE MUST NOT BE RETURNED TO THE CUSTOMER UNTIL THE REPLACEMENT HAS BEEN COMPLETED.

- **Proceed to Section C.**
- If the 0.5 mm gauge cannot be inserted between the components:
  - Proceed to the next step.

**! NOTE**

There may be a chamfer on the power recline mechanism gear. The feeler gauge may pass through the chamfer by 2-3 millimeters. This is normal. You are checking to see if the feeler gauge passes through the laser weld that would be in place.

- Bring the seats to the fully upright and forward position.

The repair information in this document is intended for use only by skilled technicians who have the proper tools, equipment and training to correctly and safely maintain your vehicle. These procedures are not intended to be attempted by "do-it-yourselfers," and you should not assume this document applies to your vehicle, or that your vehicle has the condition described. To determine whether this information applies, contact an authorized Volkswagen dealer. ©2020 Volkswagen Group of America, Inc. and Volkswagen Canada. All Rights Reserved.



Outboard Recline Mechanism (closest to the door):

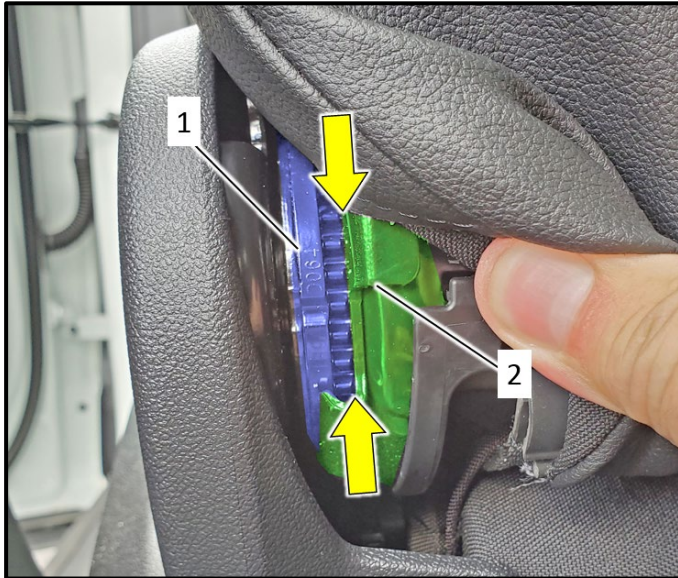

**PERFORM THE INSPECTION ON BOTH RECLINE MECHANISMS ON BOTH FRONT SEATS.**

- Pull back the seat covering to expose the recline mechanism on the back of the seat.
- Inspect the gap between recline mechanism <1> and backrest frame <2> in the area shown <between arrows> using the 0.5 mm gauge.
- You will be checking for the presence of a complete weld between recline mechanism <1> and backrest frame <2>.
- If the 0.5 mm gauge can be inserted between the components:
  - The seat frame must be replaced.

**⚠ WARNING**

IF THE BACKREST FRAME IS BEING REPLACED, THE VEHICLE MUST NOT BE RETURNED TO THE CUSTOMER UNTIL THE REPLACEMENT HAS BEEN COMPLETED.

Inboard Recline Mechanism (closest to the center tunnel):

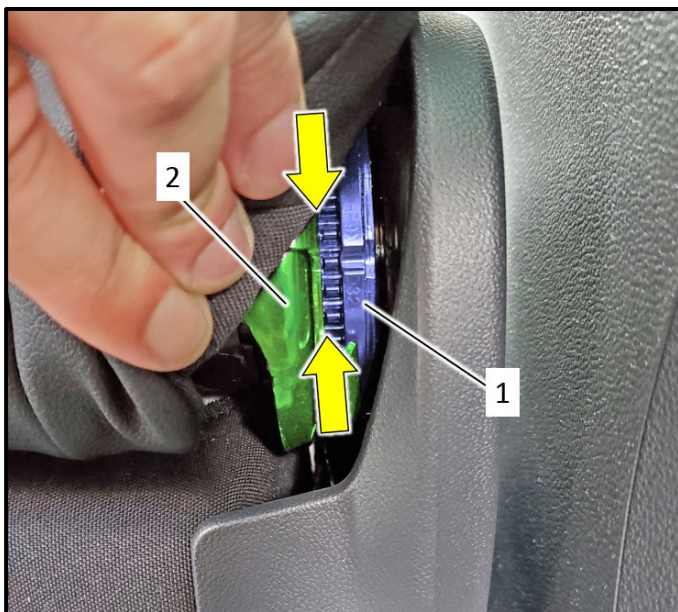

- **Proceed to Section C.**
- If the 0.5 mm gauge cannot be inserted between the components:
  - No further work is required.
  - **Proceed to Section D.**

**ⓘ NOTE**

There may be a chamfer on the power recline mechanism gear. The feeler gauge may pass through the chamfer by 2-3 millimeters. This is normal. You are checking to see if the feeler gauge passes through the laser weld that would be in place.

## Sub-section 2 – Inspecting Seat Frames – Manual Recline Seats

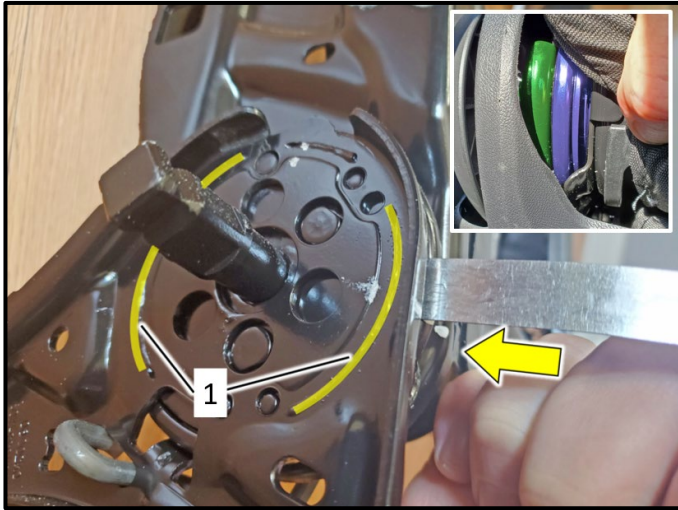

- When using the 0.5 mm feeler gauge in the following steps, you are not checking the width of the gap; the feeler gauge will act as a probe.
- When inserting the feeler gauge, push the gauge in between the components in the direction of <arrow>. You are checking to see if the gauge passes by the laser welds <1>.

### ! NOTE

Manual backrest shown in the full upright position. The process for both sides on both front seats, in the upright and reclined position is similar.



- Fully recline left front and right front seats.



Outboard Recline Mechanism (closest to the door):

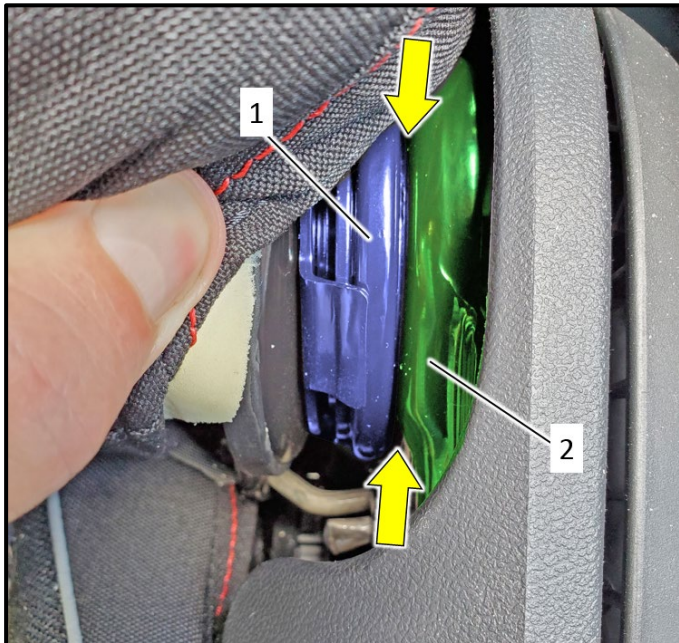

Inboard Recline Mechanism (closest to the center tunnel):



**PERFORM THE INSPECTION ON BOTH RECLINE MECHANISMS ON BOTH FRONT SEATS.**

- Pull back the seat covering to expose the recline mechanism.
- Inspect the gap between recline mechanism <1> and mounting bracket <2> in the area shown <between arrows> using the 0.5 mm gauge.
- You will be checking for the presence of a complete weld between recline mechanism <1> and mounting bracket <2>.
- If the 0.5 mm gauge can be fully inserted between the components:
  - The seat frame must be replaced.

**⚠ WARNING**

IF THE BACKREST FRAME IS BEING REPLACED, THE VEHICLE MUST NOT BE RETURNED TO THE CUSTOMER UNTIL THE REPLACEMENT HAS BEEN COMPLETED.

- **Proceed to Section C.**
- If the 0.5 mm gauge cannot be inserted between the components:
  - Proceed to the next step.

**ⓘ NOTE**

Due to the radius of the components, the feeler gauge may go in 2-3 millimeters. This is normal. You are checking to see if the feeler gauge passes through the laser weld that would be in place.



- Bring the seats to the fully upright and forward position.

Outboard Recline Mechanism (closest to the door):

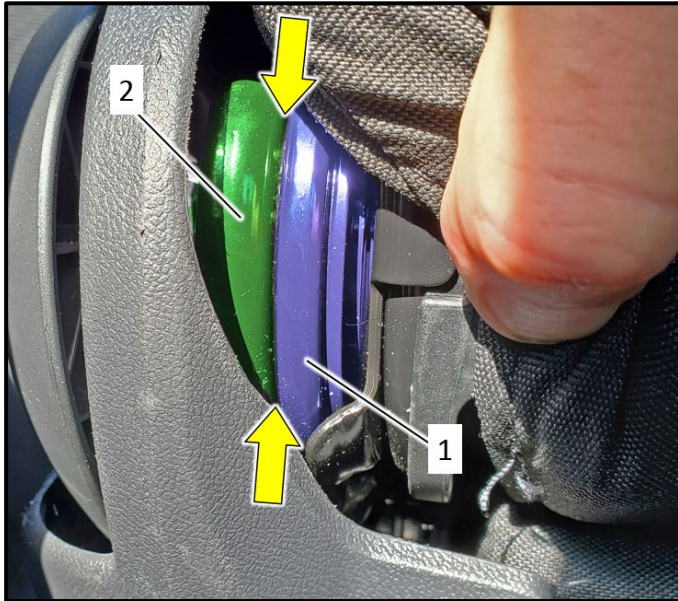

Inboard Recline Mechanism (closest to the center tunnel):

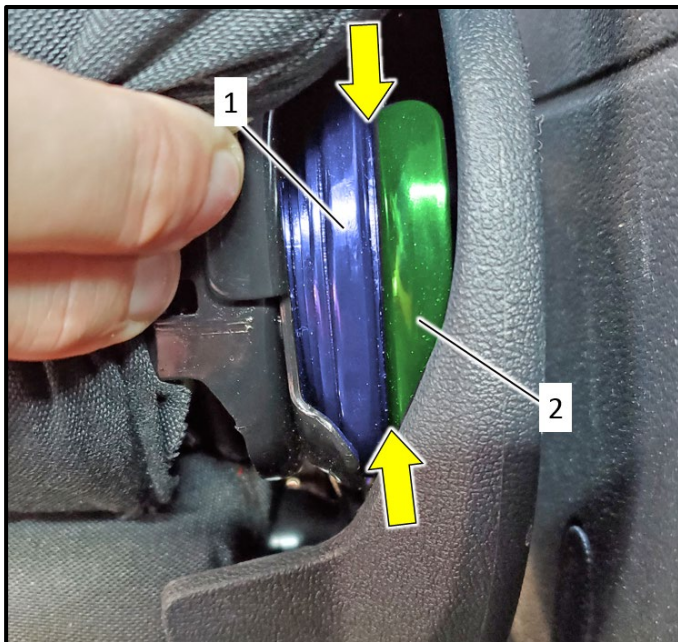

**PERFORM THE INSPECTION ON BOTH RECLINE MECHANISMS ON BOTH FRONT SEATS.**

- Pull back the seat covering to expose the recline mechanism on the back of the seat.
- Inspect the gap between recline mechanism <1> and mounting bracket <2> in the area shown <between arrows> using the 0.5 mm gauge.
- You will be checking for the presence of a complete weld between recline mechanism <1> and mounting bracket <2>.
- If the 0.5 mm gauge can be inserted between the components:
  - The seat frame must be replaced.

**⚠ WARNING**

IF THE BACKREST FRAME IS BEING REPLACED, THE VEHICLE MUST NOT BE RETURNED TO THE CUSTOMER UNTIL THE REPLACEMENT HAS BEEN COMPLETED.

- **Proceed to Section C.**
- If the 0.5 mm gauge cannot be inserted between the components:
  - No further work is required.
  - **Proceed to Section D.**

**! NOTE**

Due to the radius of the components, the feeler gauge may go in 2-3 millimeters. This is normal. You are checking to see if the feeler gauge passes through the laser weld that would be in place.



## Section C – Replacing Seat Frame

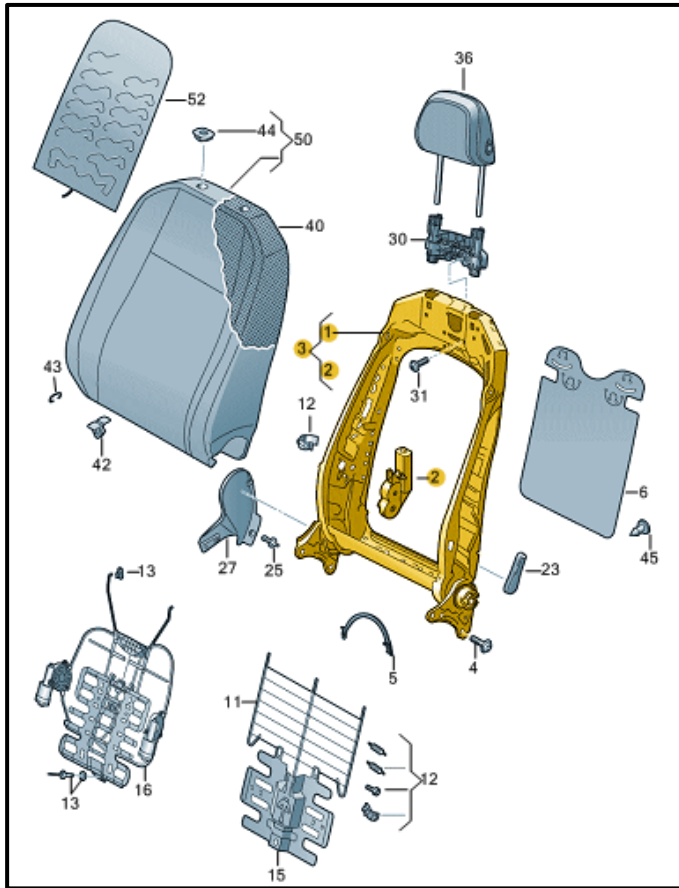

- See ELSA Repair Manual: *Repair manual > Body Interior > 72 Seat Frames > Front seats > Front Backrest, Removing and Installing*

Part Number	Part Description
SEE ETKA	Backrest frame
N -907-912-01 (one per seat)	Bolt (seat airbag - if equipped)
WHT-002-796-B (four per seat)	Bolt (backrest frame to seat pan)

- **Proceed to Section D.**

## Section D – Campaign Completion Label

### Install Campaign Completion Label

- Fill out and affix Campaign Completion Label, part number CAMP 010 000, next to the vehicle emission control information label.



#### TIP

Ensure Campaign Completion Label does not cover any existing label(s).

- **Proceed to Section E**

## Section E - Parts Return/Disposal

Properly store (retain), destroy or dispose of removed parts in accordance with all state/province and local requirements, unless otherwise indicated and/or requested through the Warranty Parts Portal (WPP) for U.S. and the Part Destruction and Core Disposition Report for Canada.