

IMPORTANT UPDATE

TECHNICAL INSTRUCTIONS

FOR

SAFETY RECALL 20TA04

CERTAIN ENGINE BLOCKS CAN CAUSE ENGINE FAILURE LEADING TO ENGINE STALL (non-hybrid) and/or FIRE RISK

CERTAIN 2019 - 2020 RAV4 HV

(2019 - 2020 RAV4 non-hybrid is a separate document)

Update 8/18/2021: Instructions added for engine short block replacement in the case engine assembly is not available, and Tech Certification updated.

Update 6/24/2020: Engine Assembly Replacement procedure is now included

The repair quality of covered vehicles is extremely important to Toyota. All dealership technicians performing this repair are required to successfully complete the most current version of the E-Learning course "Safety Recall and Service Campaign Essentials". To ensure that all vehicles have the repair performed correctly; technicians performing this repair are required to currently have completed all of the following courses:

- T151 - Toyota Engine Service and Repair

It is the dealership's responsibility to select technicians that have completed the above courses to perform this repair. Carefully review your resources, the technician skill level, and ability before assigning technicians to this repair. It is important to consider technician days off and vacation schedules days to ensure there are properly trained technicians available to perform this repair at all times.

I. OPERATION FLOW CHART

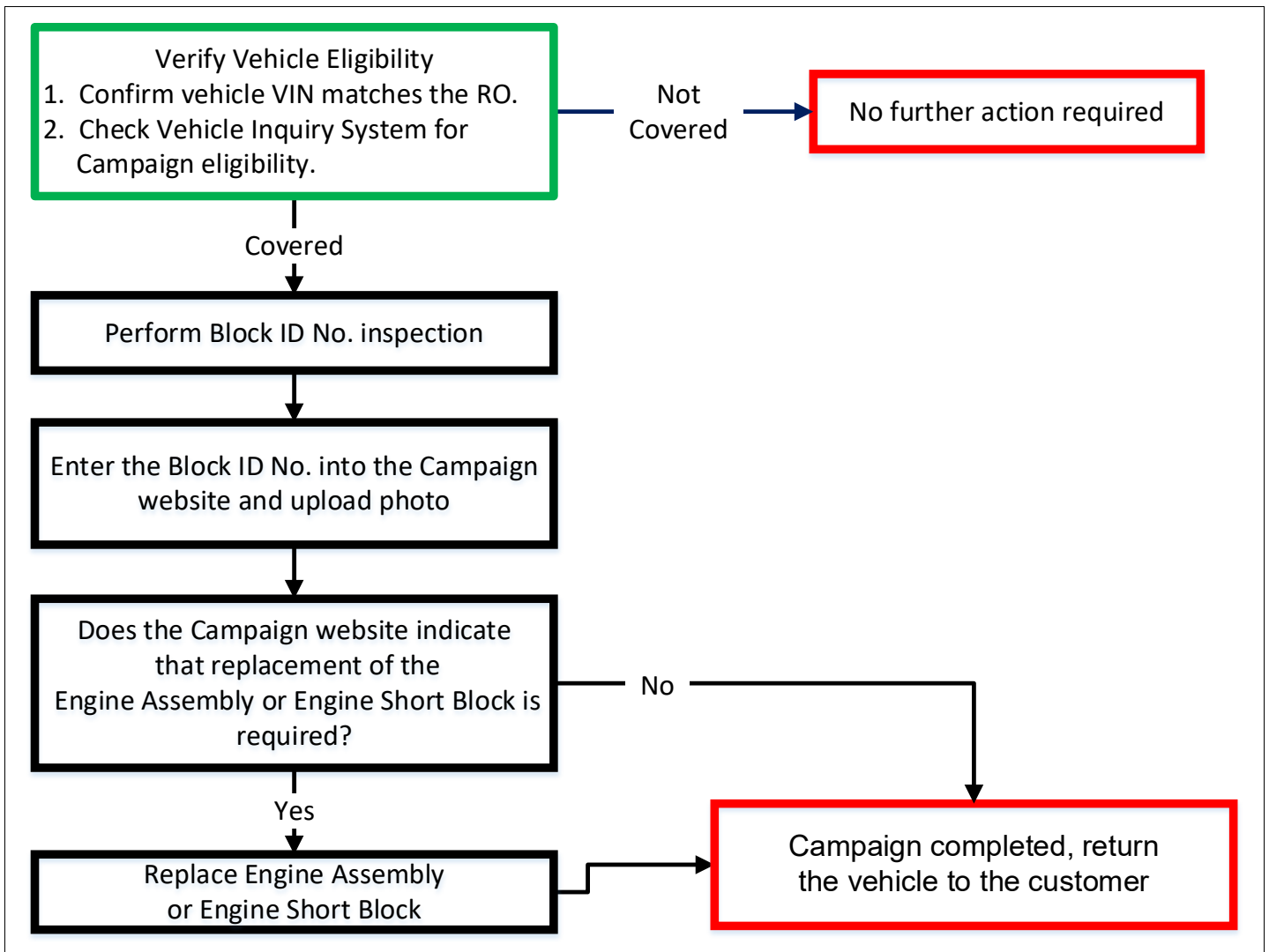

II. IDENTIFICATION OF AFFECTED VEHICLES

- Check the TIS Vehicle Inquiry System to confirm the VIN is involved in this Safety Recall, and that it has not already been completed prior to dealer shipment or by another dealer.
- TMS warranty will not reimburse dealers for repairs completed on vehicles that are not affected or were completed by another dealer.

III. PREPARATION

A. PARTS

INSPECTION ONLY:

No parts are required for the inspection of the Block ID No. Parts will only be necessary if the replacement of the Engine Assembly or Engine Short Block is required, as determined by the inspection.

ENGINE ASSEMBLY OR ENGINE SHORT BLOCK REPLACEMENT:

Because of the extensive list of parts and variations of the model, a website has been created to detail the required parts for each vehicle. Reference the following website for a detailed parts list for **each specific VIN:**

<https://20TA04-20LA02-safety-recall.imagespm.info/>

Note: Warranty will only reimburse dealers for the part numbers listed on the website. Any other part numbers will not be accepted on the campaign claim.

B. TOOLS & EQUIPMENT

- Techstream
- Engine Hoist
- Standard Hand Tools
- Engine Stand
- Torque Wrench

SST – These Special Service Tools are required for this repair:

Part Number	Tool Name	Quantity
00002-11100-02	Transmission Fluid Pump	1
09213-54015	Crankshaft Tool	1
09330-00021	Companion Flange Tool	1
09950-50013	Puller Set	1

IV. BACKGROUND

Some of the subject vehicles may be equipped with an engine block that was manufactured incorrectly. This issue may cause coolant to leak internally and/or externally during normal engine operation. This can lead to engine noise, engine smoke, warning lights/malfunction indicator illumination, an audible chime sounding, and/or, in some cases, engine overheating and possible internal mechanical engine damage. If this occurs in a conventional gasoline vehicle, it is possible the vehicle could stall while driving at higher speeds without prior warning, increasing the risk of a crash. For both hybrid and conventional gasoline vehicles, the mechanical engine damage could cause engine oil to leak, which, in the presence of an ignition source, can lead to an increased risk of fire.

NOTE: If the engine stalls in a hybrid vehicle, the vehicle will enter a fail safe driving mode, allowing the driver to operate the vehicle at reduced power for certain distances to maneuver the vehicle to a safe location.

V. SAFETY PRECAUTIONS

CAUTION:

This vehicle has a hybrid control system that operates at voltages of up to 650 V. Be sure to follow the instructions in this manual to handle the system correctly. Failure to do so may result in serious injury or electrocution.

- (a) Technicians must undergo special training to be able to service and inspect the high-voltage system.
- (b) All high-voltage wire harnesses and connectors are colored orange. The HV battery and other high-voltage components have "High Voltage" caution labels. Do not carelessly touch these wires or components.
- (c) When there is a problem with the wire harness or connector of a high-voltage circuit, repairs to the harness or connector should not be attempted. Replace damaged or malfunctioning high voltage cables or connectors.
- (d) Before inspecting or servicing the high-voltage system, be sure to follow all safety measures, such as wearing insulated gloves and removing the service plug to prevent electrocution. Carry the removed service plug in your pocket to prevent other technicians from accidentally reconnecting it while you are servicing the vehicle.

NOTICE:

After removing the service plug grip, do not turn the power switch on (READY), unless instructed by the repair manual because this may cause a malfunction.

- (e) After removing the service plug grip, wait 10 minutes before touching any of the high-voltage connectors and terminals.

HINT:

Waiting for at least 10 minutes is required to discharge the high-voltage capacitor inside the inverter with converter assembly.

- (f) Before using insulated gloves, be sure to check them for cracks, tears and other types of damage.
- (g) When servicing the vehicle, do not carry metal objects like mechanical pencils or rulers that can be dropped accidentally and cause a short circuit.
- (h) Before touching a bare high-voltage terminal, wear insulated gloves and use a tester to make sure that the terminal voltage is 0 V.

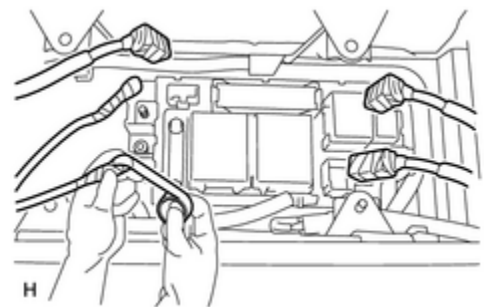

- (i) After disconnecting or exposing a high-voltage connector or terminal, insulate it immediately using insulating tape.
- (j) Bolts and nuts for high-voltage terminals should be tightened firmly to the specified torque. Both insufficient and excessive torque can cause failure.
- (k) Use the "CAUTION: HIGH VOLTAGE DO NOT TOUCH" sign to notify other technicians that the high-voltage system is being inspected and/or repaired.
- (l) After servicing the high-voltage system and before reinstalling the service plug, check again that you have not left a part or tool inside, that the high-voltage terminals are firmly tightened, and that the connectors are correctly connected.
- (m) When performing work involving high-voltage wires, use either a tool wrapped with vinyl insulation tape or an insulated tool.
- (n) When installing hybrid control system components such as the HV battery, make sure that the polarity of all connections is correct.

CAUTION:

- Do not touch any bare cables that may have high-voltage. If a cable must be touched or if accidental contact is possible, wear insulated gloves and insulate the cable using insulating tape.

- Visually check the HV battery and the immediate area for any electrolyte leakage. Do not touch any leaked liquid because it could be organic electrolyte that contains carbonic acid esters.
- The electrolyte is flammable. Keep all ignition sources such as open flame and hot objects away from the electrolyte.
- Electrolyte leaks may cause acute poisoning if a high concentration of the vapor from the organic solvent is inhaled. In case of inhalation, move the affected person to a place with ample fresh air and let them lie quietly. Seek medical care.
- In case of skin contact with the electrolyte, wash the area thoroughly with soap and plenty of water, and seek medical care. Immediately remove any contaminated clothing. Prolonged contact with the electrolyte may cause skin irritation.
- If the electrolyte comes in contact with your eyes, call out loudly for help. Do not rub your eyes. Immediately flush them with a large amount of water for at least 15 minutes and seek medical care.
- If electrolyte is swallowed, seek medical care immediately. Do not induce vomiting, unless instructed by the doctor.
- Wear insulated or rubber gloves, goggles, and safety shoes.
- Check the HV battery and immediate area for any electrolyte leakage.
- Do not touch any bare cables that could be high voltage cables. If a cable must be touched or if accidental contact is possible, follow the following instructions: 1) wear insulated gloves and goggles, 2) measure the voltage between the cable and body ground using an electrical tester, and 3) insulate the cable using insulating tape.
- Do not touch any bare cables that may have high-voltage. If a cable must be touched or if accidental contact is possible, wear insulated gloves and insulate the cable using insulating tape.
- Do not touch any leaked liquid because it could be the organic electrolyte that contains carbonic acid esters. If contact is unavoidable, wipe the fluid off using a cloth while wearing rubber gloves, goggles and an organic solvent mask. Do not leave electrolyte-contaminated cloths unattended. Place contaminated cloths in an appropriate airtight container and dispose of them according to local regulations.
- Accidents such as electric shock may result if the HV battery or a hybrid vehicle supply stack sub-assembly is disposed of improperly or abandoned. Therefore, make sure to return all HV batteries or hybrid vehicle supply stack assemblies through an authorized collection agent.
- To reduce the risk of fire, the HV battery or hybrid vehicle supply stack assembly must not be stored in an area where it will be exposed to fire or high temperatures.

VI. COMPONENTS

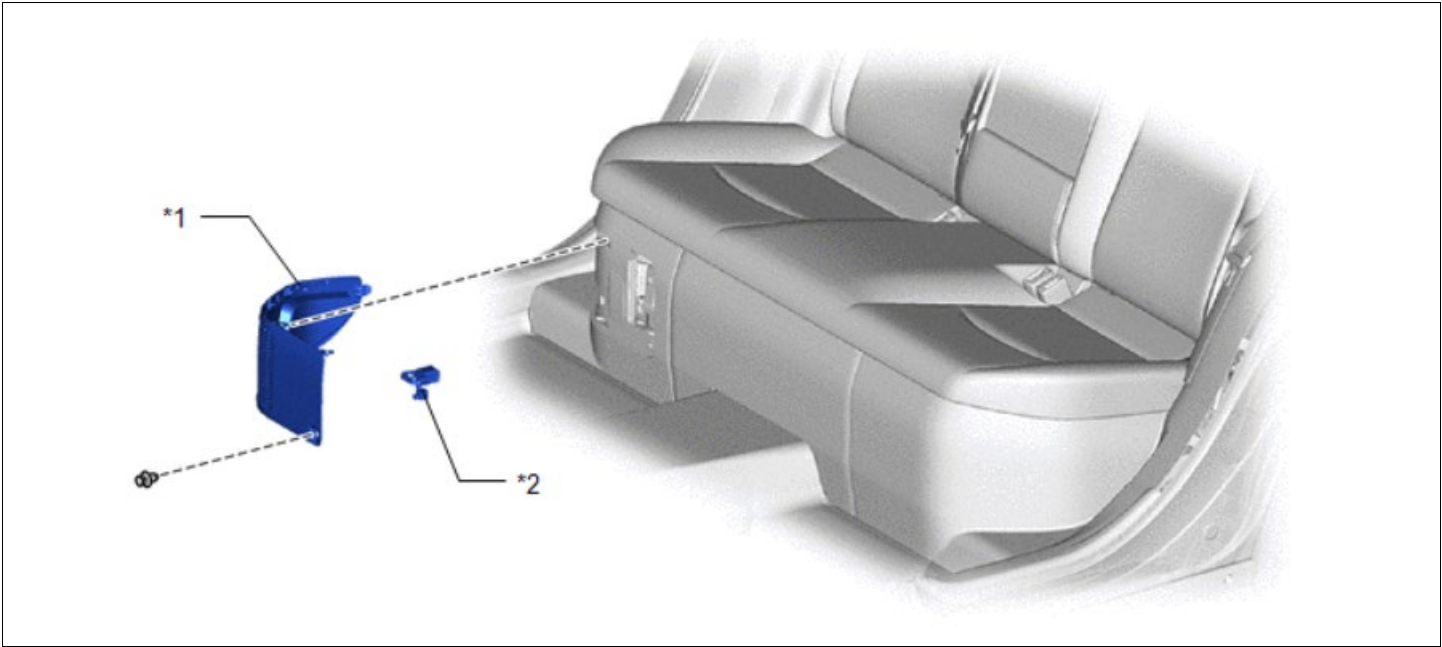

*1	BATTERY SERVICE HOLE COVER	*2	SERVICE PLUG GRIP
----	----------------------------	----	-------------------

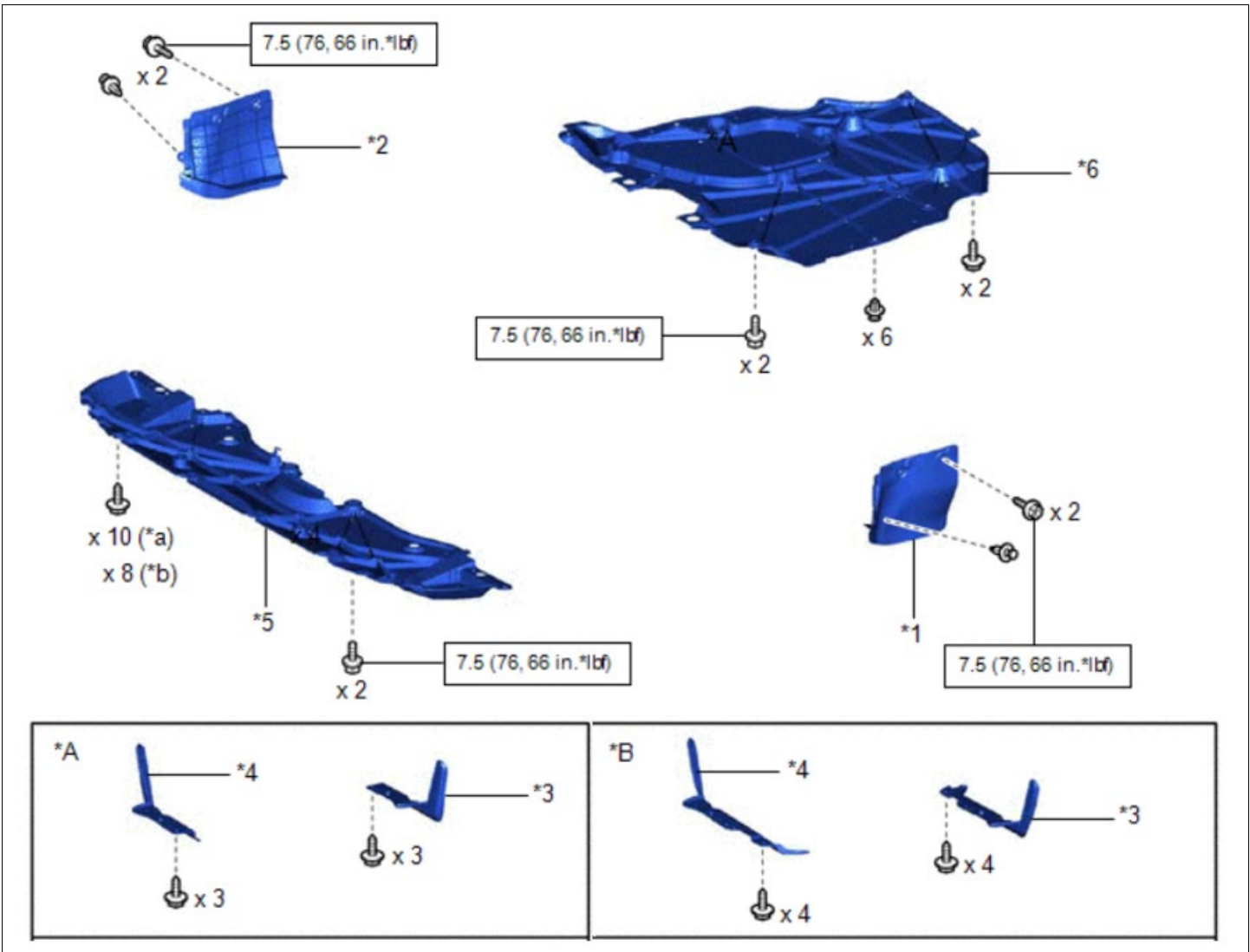

*A	for Short Type	*B	for Long Type
*1	FRONT FENDER APRON SEAL LH	*2	FRONT FENDER APRON SEAL RH
*3	FRONT FENDER FRONT SPLASH SHIELD LH	*4	FRONT FENDER FRONT SPLASH SHIELD RH
*5	NO. 1 ENGINE UNDER COVER	*6	NO. 2 ENGINE UNDER COVER ASSEMBLY
*a	Short Type Front Fender Front Splash Shield	*b	Long Type Front Fender Front Splash Shield
	N*m (kgf*cm, ft.*lbf): Specified torque	-	-

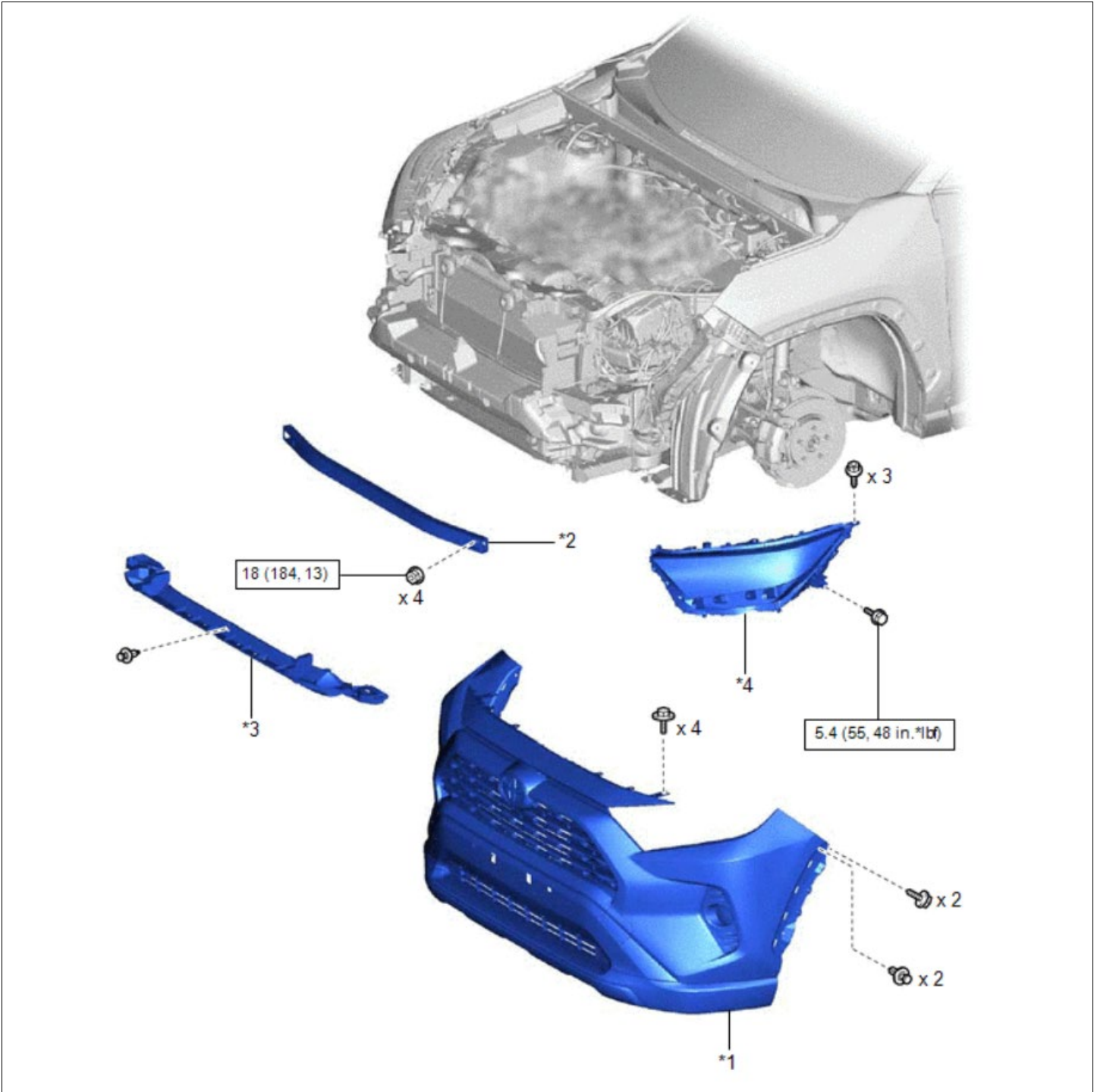

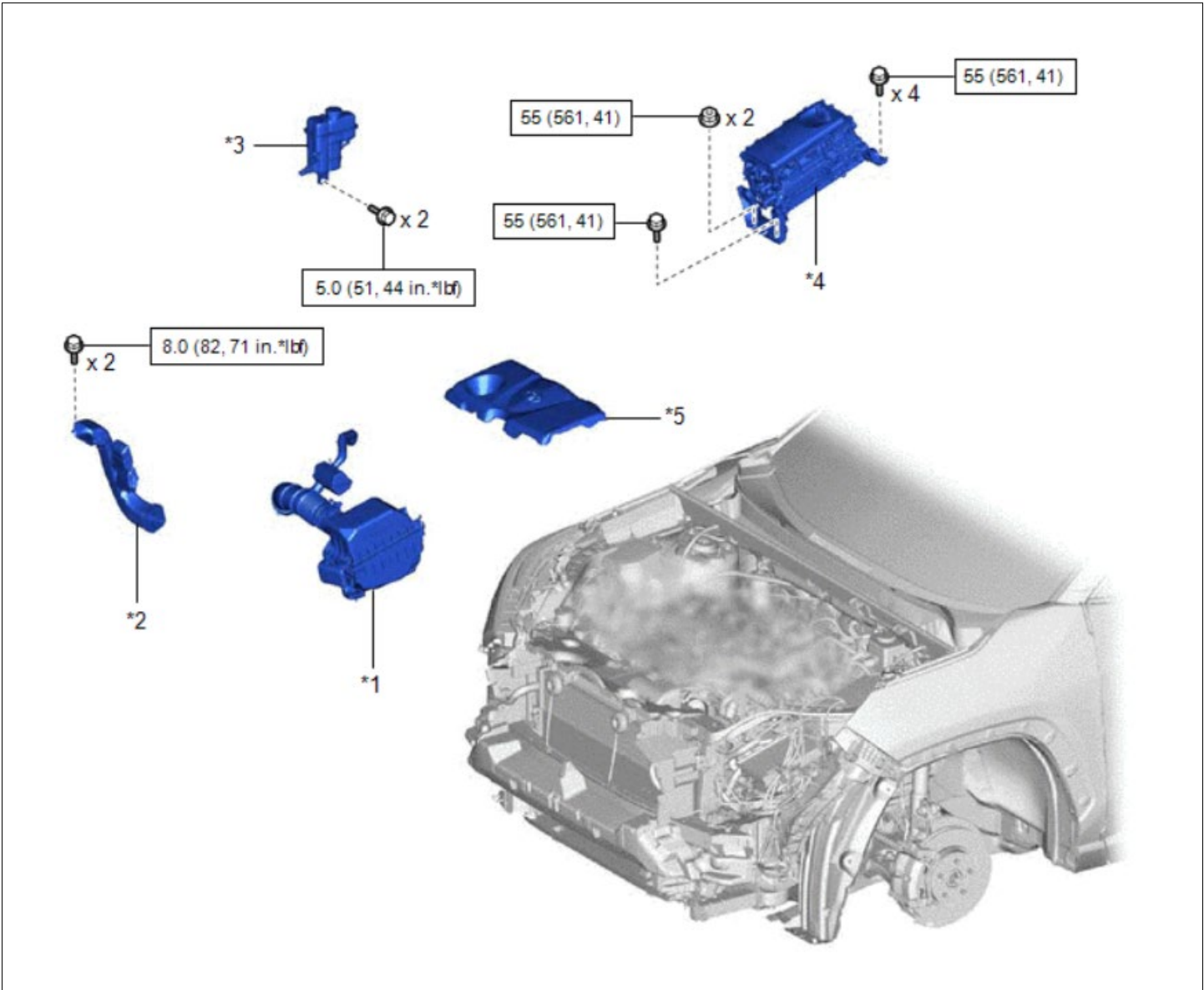

*1	FRONT BUMPER ASSEMBLY	*2	FRONT BUMPER NO. 2 REINFORCEMENT
*3	FRONT LOWER BUMPER ABSORBER	*4	HEADLIGHT ASSEMBLY LH
	N*m (kgf*cm, ft.*lbf): Specified torque	-	-



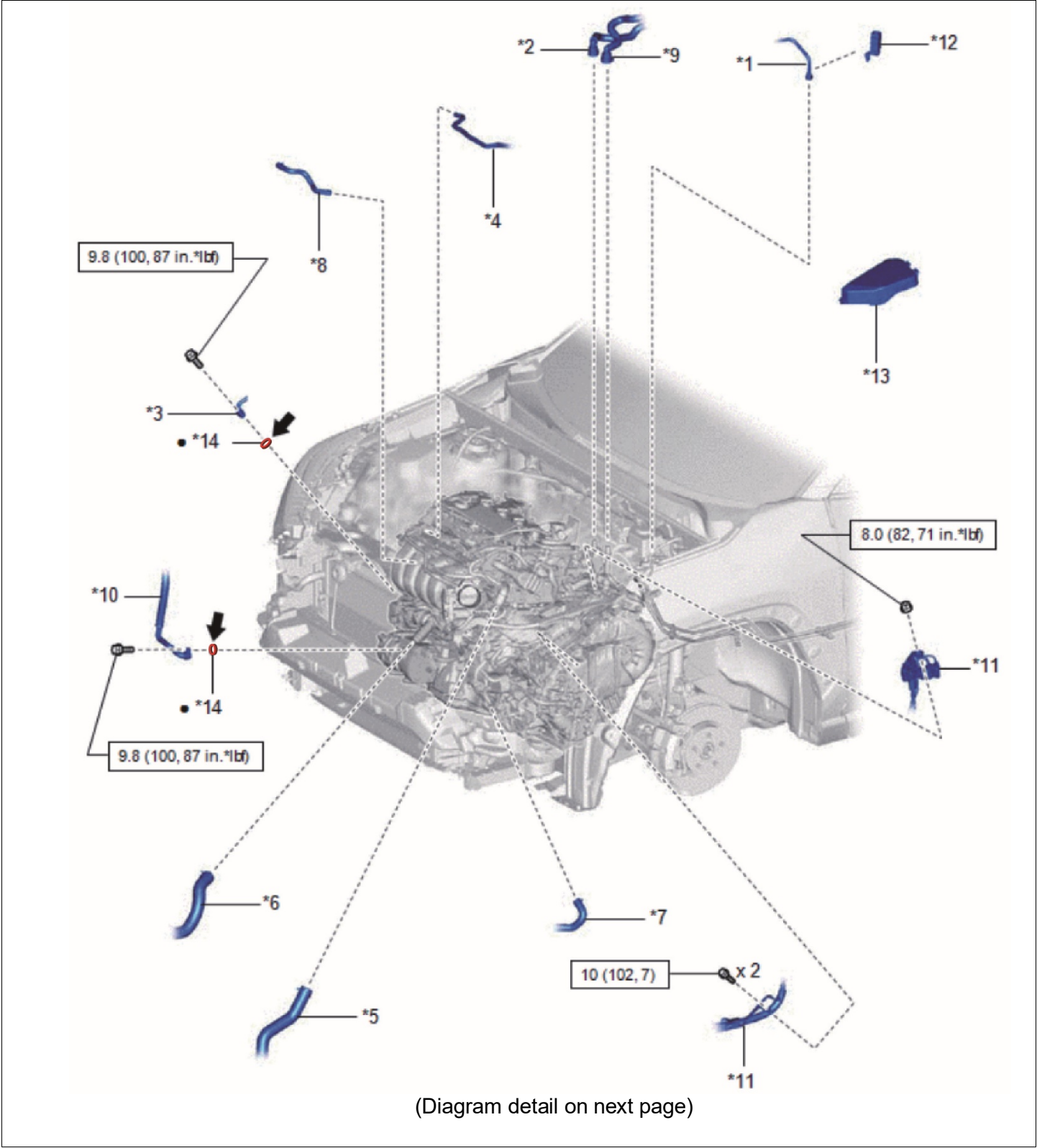

*1	AIR CLEANER ASSEMBLY WITH AIR CLEANER HOSE	*2	INLET AIR CLEANER ASSEMBLY
*3	INVERTER RESERVE TANK ASSEMBLY	*4	INVERTER WITH CONVERTER ASSEMBLY
*5	NO. 1 ENGINE COVER SUB-ASSEMBLY	-	-
	N*m (kgf*cm, ft.*lbf): Specified torque	-	-

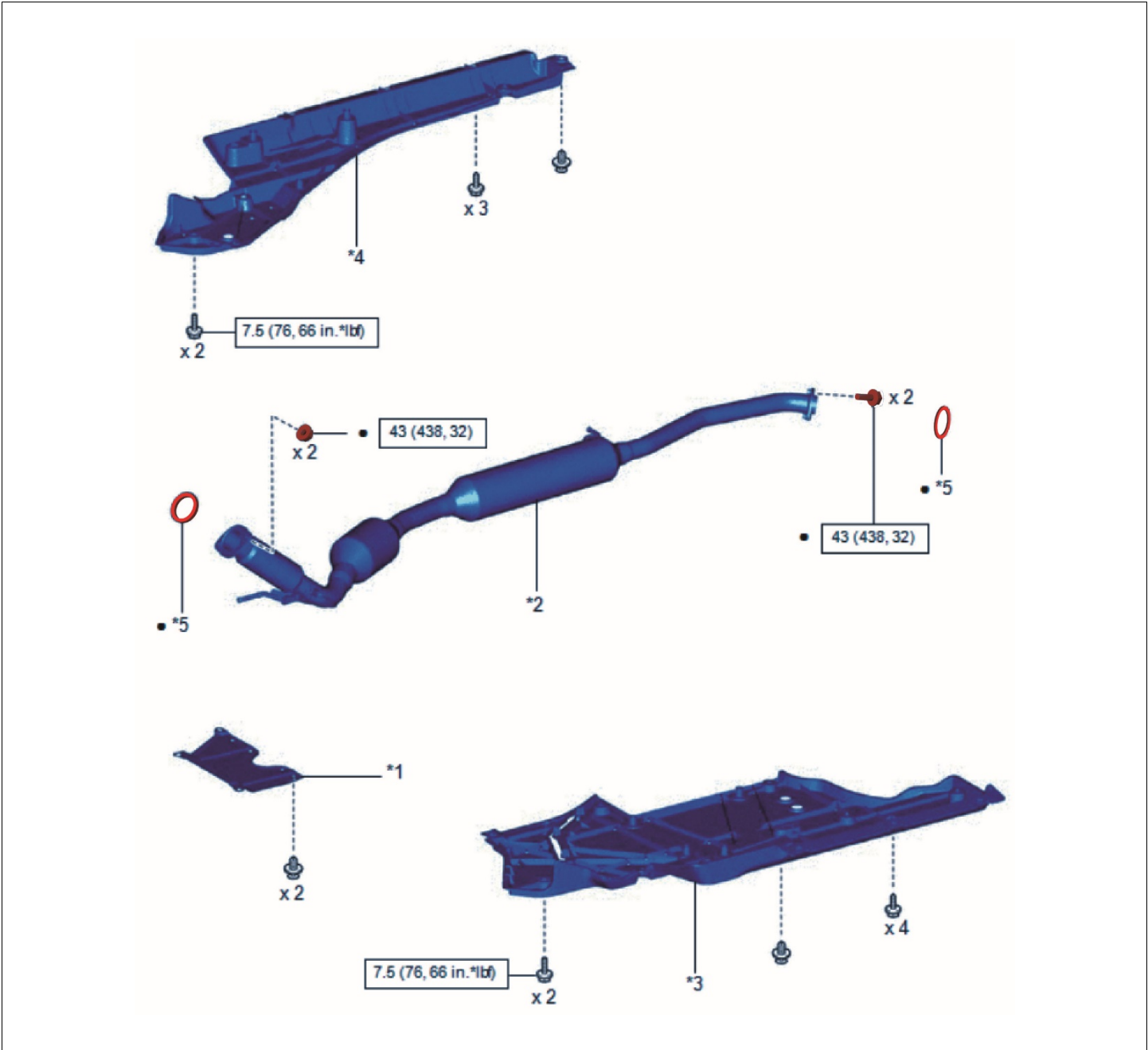

*1	FUEL TUBE SUB-ASSEMBLY	*2	INLET HEATER WATER HOSE
*3	NO. 1 COOLER REFRIGERANT DISCHARGE HOSE	*4	NO. 1 FUEL VAPOR FEED HOSE
*5	NO. 1 RADIATOR HOSE	*6	NO. 2 RADIATOR HOSE
*7	NO. 5 INVERTER COOLING HOSE	*8	NO. 5 WATER BY-PASS HOSE
*9	OUTLET HEATER WATER HOSE	*10	SUCTION HOSE SUB-ASSEMBLY
*11	WIRE HARNESS	*12	NO. 1 FUEL PIPE CLAMP
*13	NO. 2 RELAY BLOCK COVER	*14	O-RING
	N*m (kgf*cm, ft.*lbf): Specified torque	•	Non-reusable part
	Compressor oil ND-OIL 11 or equivalent	-	-





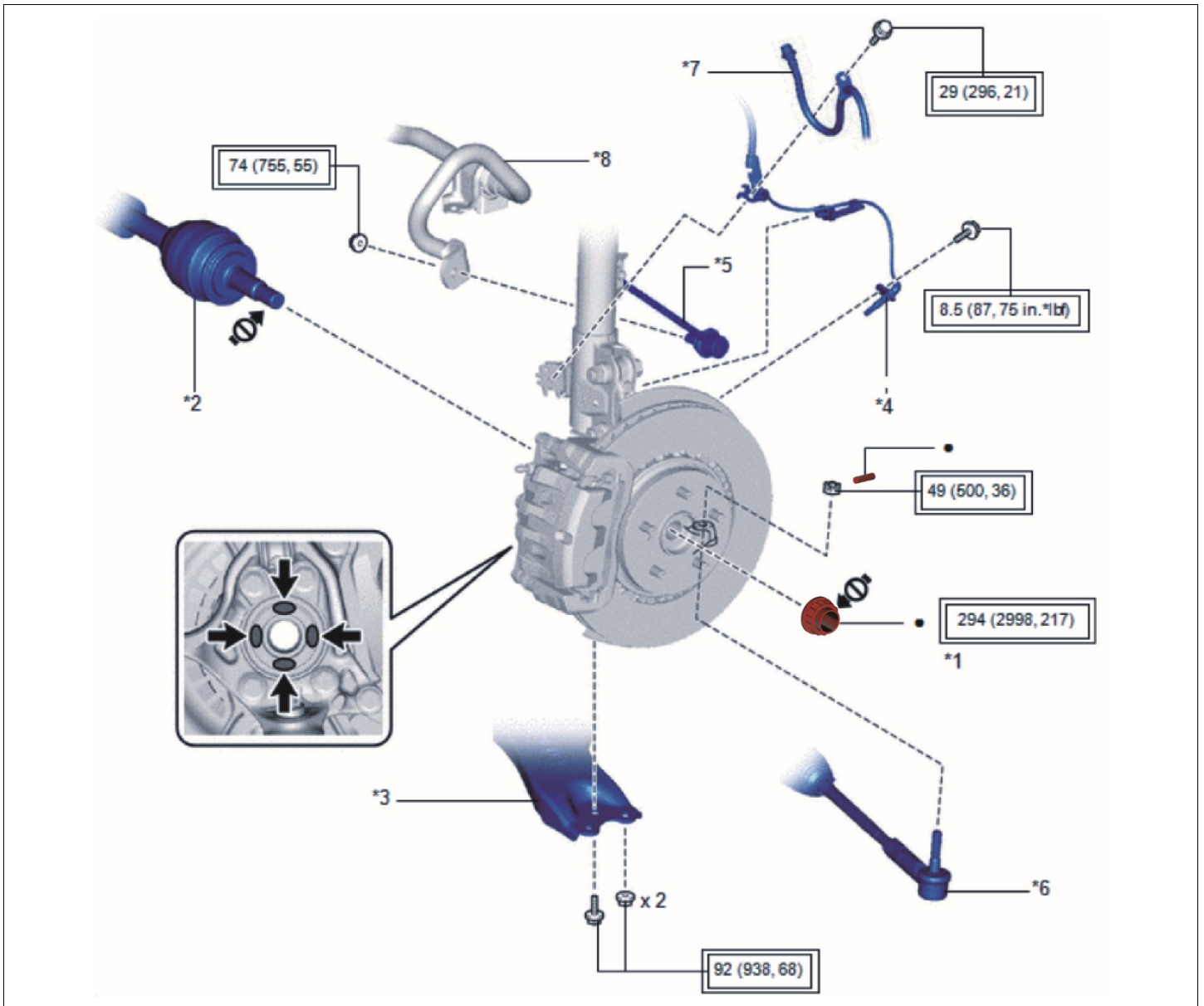

*1	ENGINE UNDER COVER HEAT INSULATOR	*2	FRONT EXHAUST PIPE ASSEMBLY
*3	FRONT FLOOR COVER LH	*4	FRONT FLOOR COVER RH
*5	GASKET	-	-
	N*m (kgf*cm, ft.*lbf): Specified torque		Non-reusable part

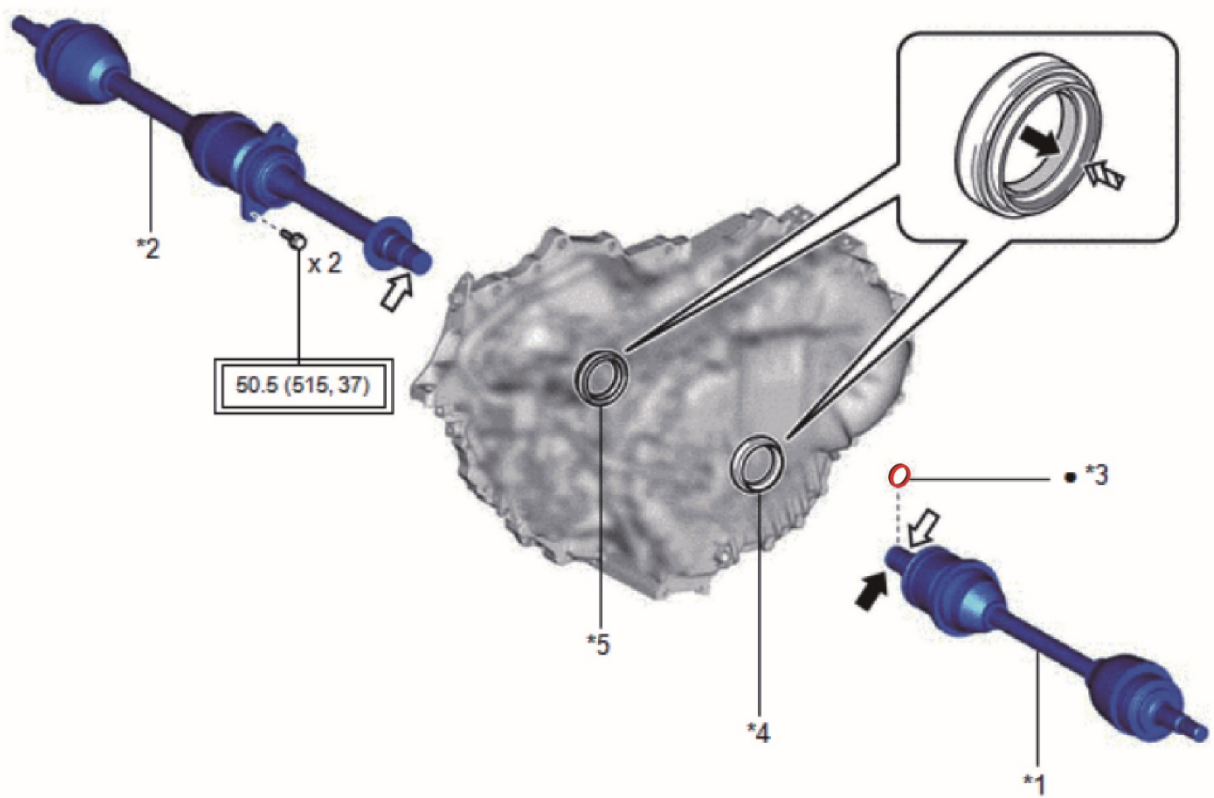

*1	FRONT AXLE SHAFT NUT LH	*2	FRONT DRIVE SHAFT ASSEMBLY LH
*3	FRONT LOWER NO. 1 SUSPENSION ARM SUB-ASSEMBLY LH	*4	FRONT SPEED SENSOR LH
*5	FRONT STABILIZER LINK ASSEMBLY LH	*6	TIE ROD ASSEMBLY LH
*7	FRONT FLEXIBLE HOSE	*8	FRONT STABILIZER BAR
	Tightening torque for "Major areas involving basic vehicle performance such as moving/turning/stopping": N*m (kgf*cm, ft.*lbf)	•	Non-reusable part
	Toyota Body Grease W		Do not apply lubricants to the threads



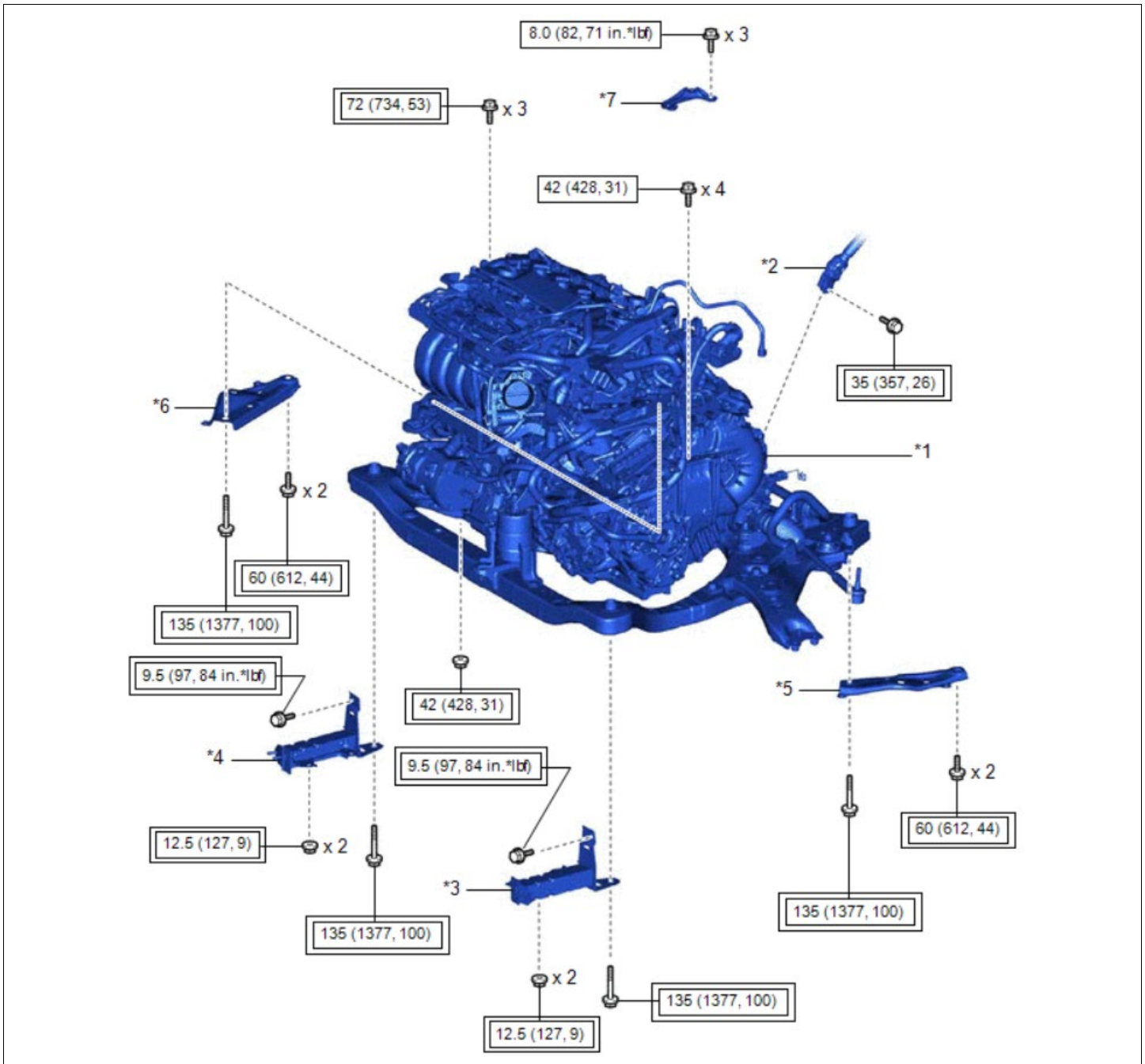

*1	FRONT DRIVE SHAFT ASSEMBLY LH	*2	FRONT DRIVE SHAFT ASSEMBLY RH
*3	FRONT DRIVE SHAFT HOLE SNAP RING	*4	FRONT DRIVE SHAFT OIL SEAL LH
*5	FRONT DRIVE SHAFT OIL SEAL RH	-	-
	Tightening torque for "Major areas involving basic vehicle performance such as moving/turning/stopping": N*m (kgf*cm, ft.*lbf)	•	Non-reusable part
	MP grease		Toyota Genuine ATF WS
	Toyota Genuine Oil Seal Side Lip Grease	-	-

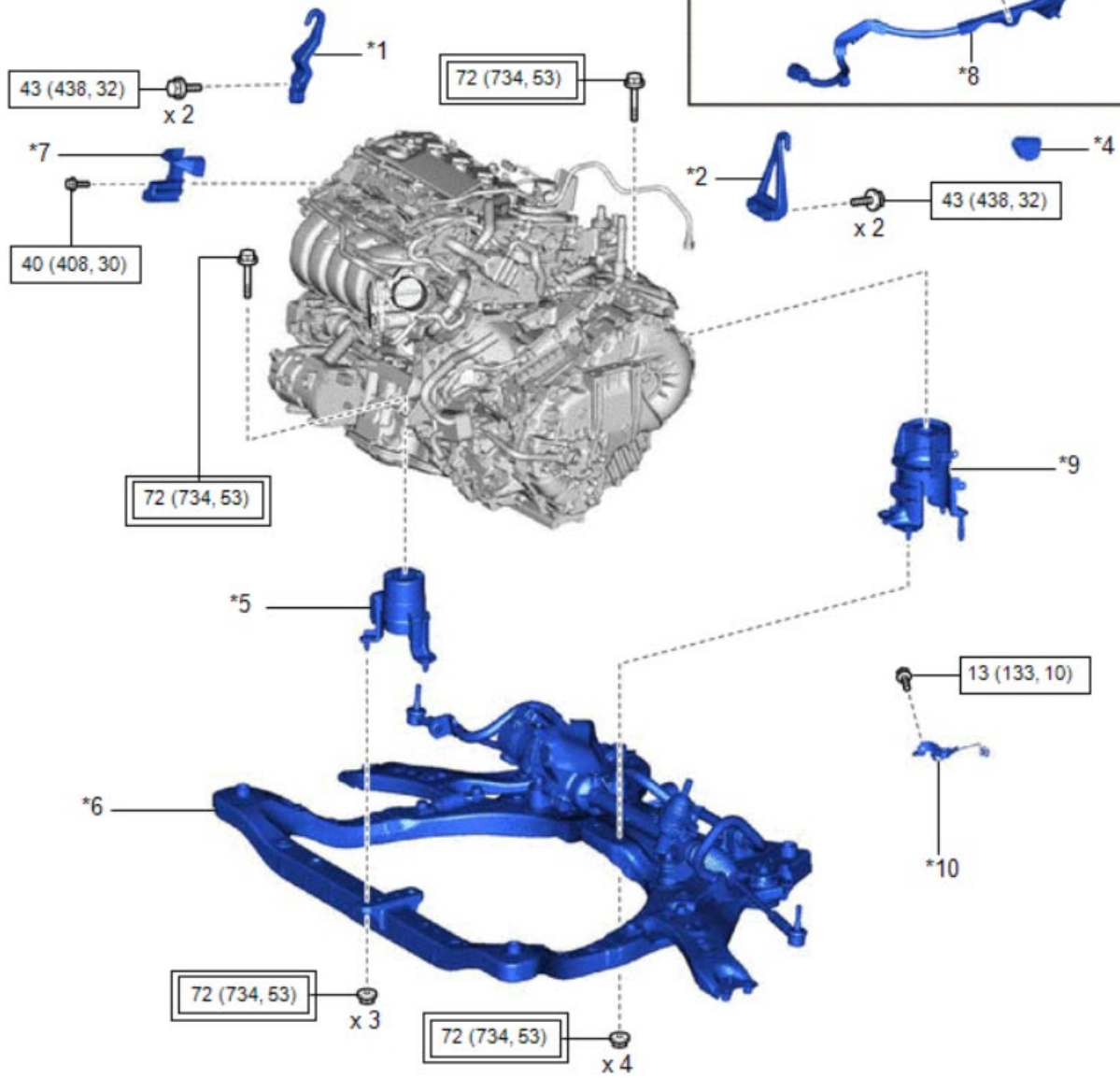
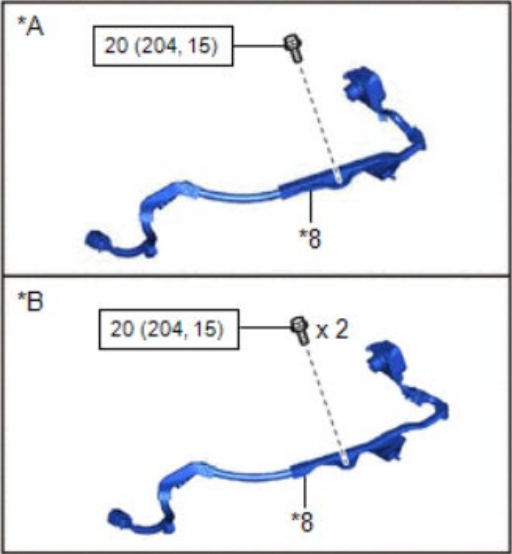
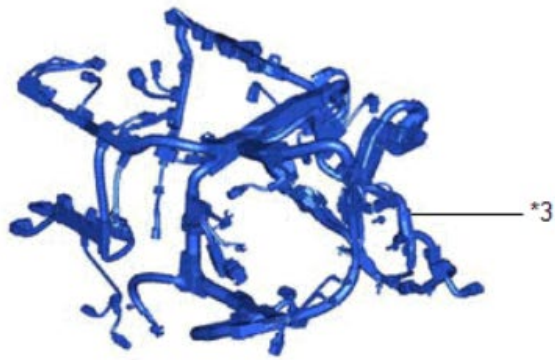

*1	ENGINE ASSEMBLY WITH TRANSAXLE	*2	STEERING INTERMEDIATE SHAFT ASSEMBLY
*3	FRONT BUMPER EXTENSION SUB-ASSEMBLY LH	*4	FRONT BUMPER EXTENSION SUB-ASSEMBLY RH
*5	REAR FRONT SUSPENSION MEMBER BRACE SUB-ASSEMBLY LH	*6	REAR FRONT SUSPENSION MEMBER BRACE SUB-ASSEMBLY RH
*7	ENGINE MOUNTING STAY LH	-	-
	Tightening torque for "Major areas involving basic vehicle performance such as moving/turning/stopping": N*m (kgf*cm, ft.*lbf)		N*m (kgf*cm, ft.*lbf): Specified torque



(Diagram detail on next page)

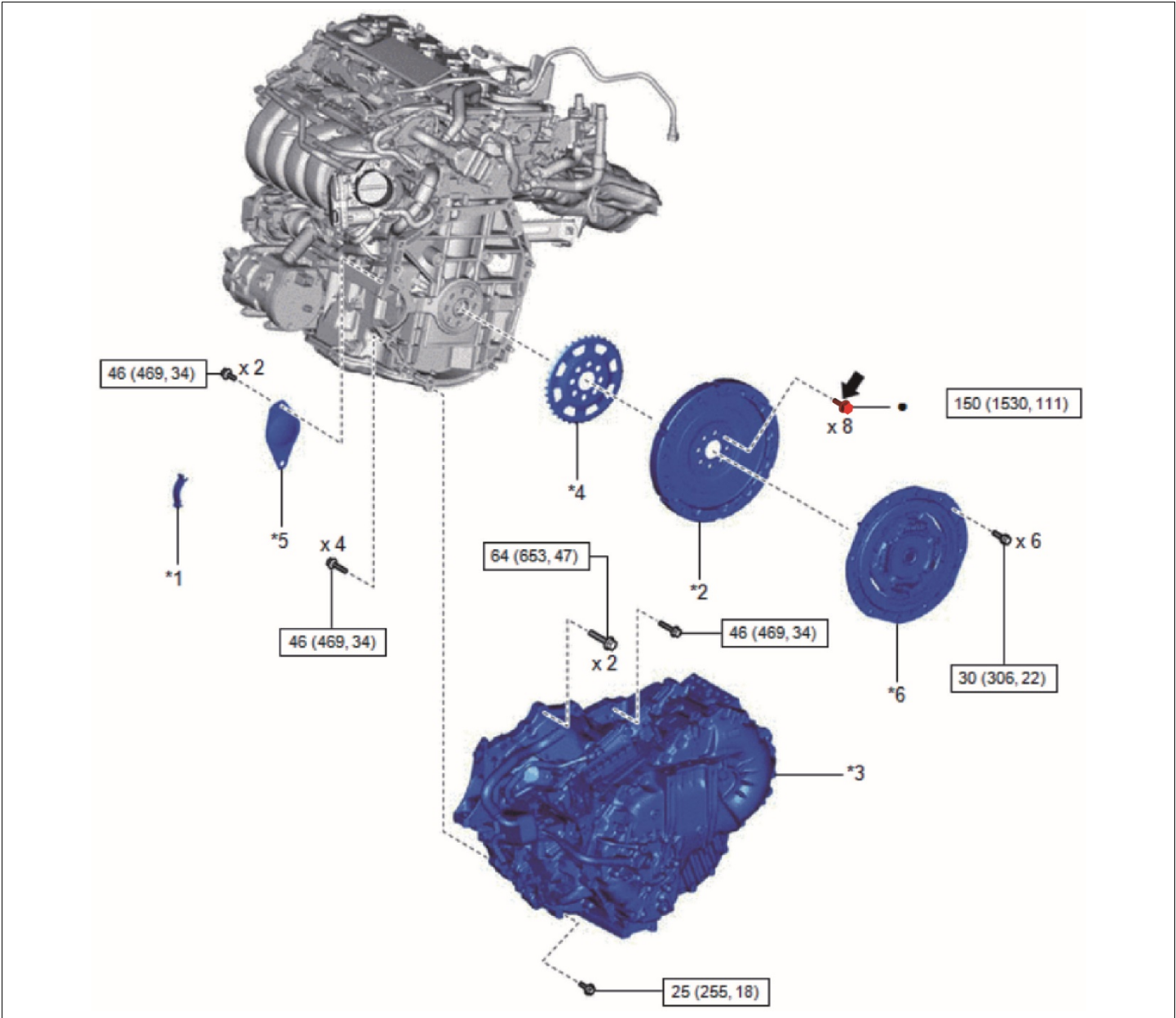

*A	for 2WD	*B	for AWD
*1	NO. 1 ENGINE HANGER	*2	NO. 2 ENGINE HANGER
*3	ENGINE WIRE	*4	FLYWHEEL HOUSING UNDER COVER
*5	FRONT ENGINE MOUNTING INSULATOR	*6	FRONT FRAME ASSEMBLY
*7	FUEL DELIVERY GUARD	*8	HV AIR CONDITIONING WIRE
*9	REAR ENGINE MOUNTING INSULATOR	*10	WIRING HARNESS CLAMP BRACKET
	Tightening torque for "Major areas involving basic vehicle performance such as moving/turning/stopping": N*m (kgf*cm, ft.*lbf)		N*m (kgf*cm, ft.*lbf): Specified torque

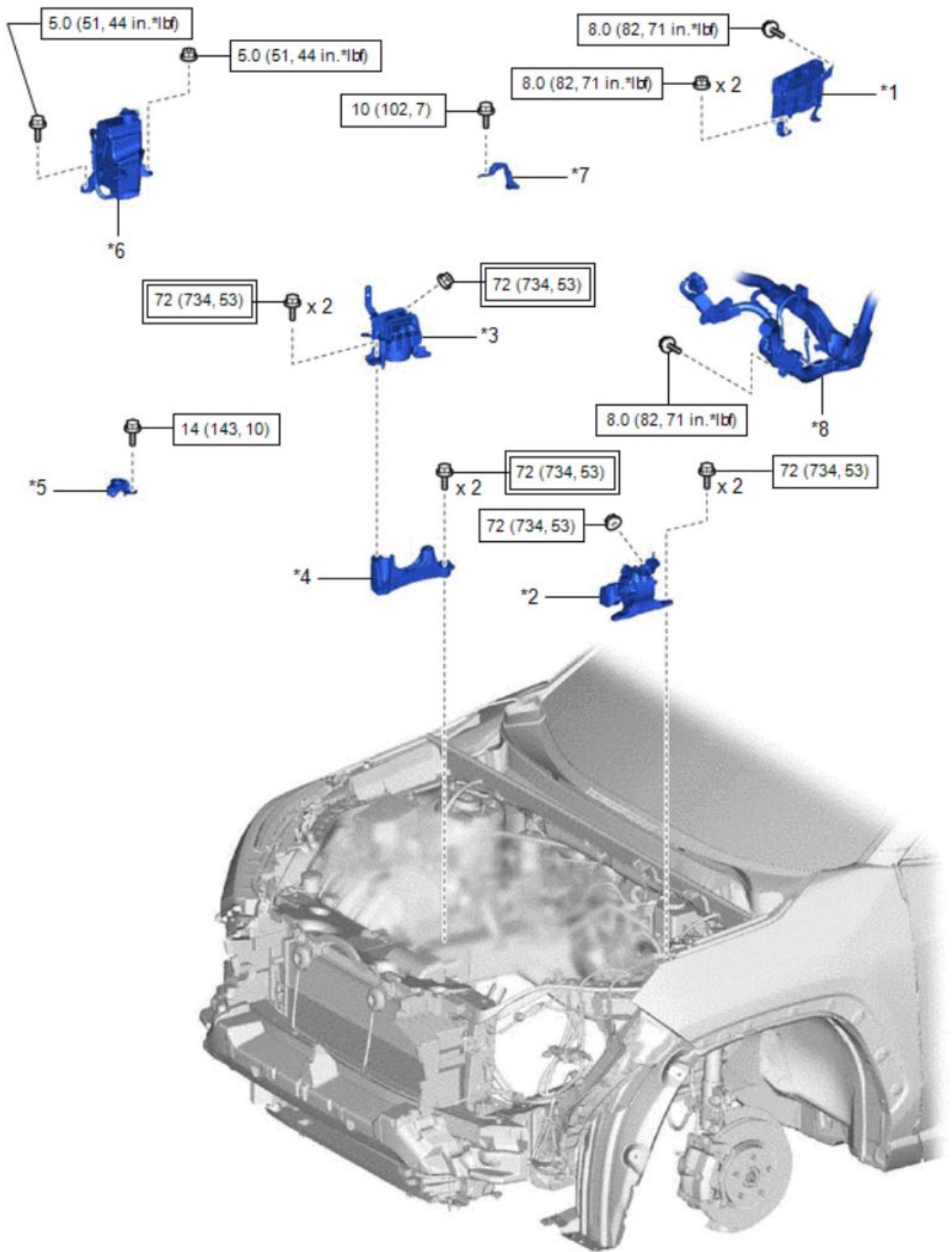

*1	FLYWHEEL HOUSING SIDE COVER	*2	FLYWHEEL SUB-ASSEMBLY
*3	HYBRID VEHICLE TRANSAXLE ASSEMBLY	*4	NO. 1 CRANKSHAFT POSITION SENSOR PLATE
*5	STARTER HOLE INSULATOR	*6	TRANSMISSION INPUT DAMPER ASSEMBLY
	N*m (kgf*cm, ft.*lbf): Specified torque	•	Non-reusable part
	Adhesive 1324	★	Precoated part



(Diagram detail on next page)

*1	ECM	*2	ENGINE MOUNTING INSULATOR SUB-ASSEMBLY LH
*3	ENGINE MOUNTING INSULATOR SUB-ASSEMBLY RH	*4	ENGINE MOUNTING SPACER
*5	NO. 1 INVERTER RESERVE TANK BRACKET	*6	RADIATOR RESERVE TANK ASSEMBLY
*7	NO. 2 GROUND WIRE	*8	ENGINE ROOM MAIN WIRE
	Tightening torque for "Major areas involving basic vehicle performance such as moving/turning/stopping": N*m (kgf*cm, ft.*lbf)		N*m (kgf*cm, ft.*lbf): Specified torque

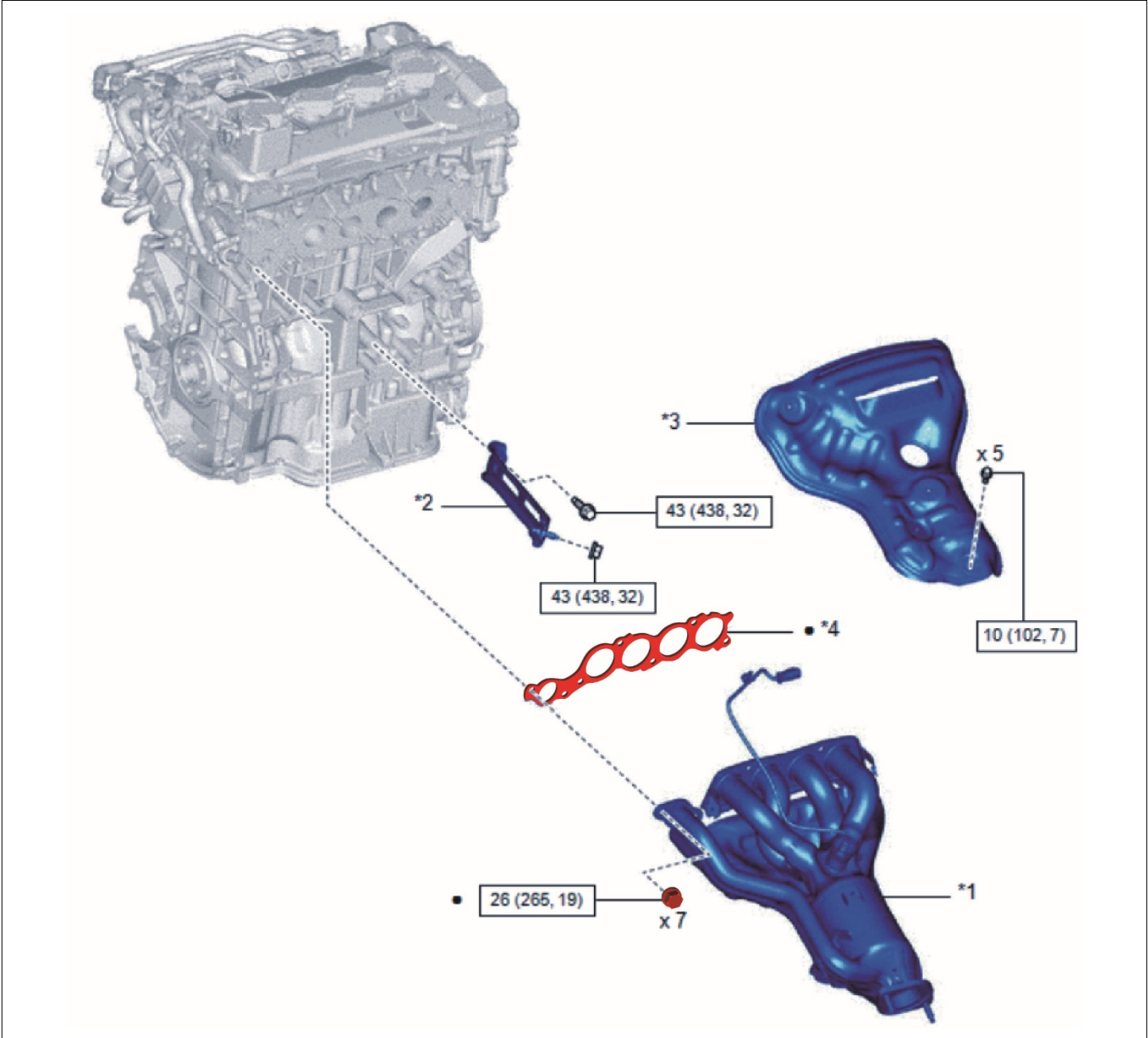

*1	EXHAUST MANIFOLD	*2	MANIFOLD STAY
*3	NO. 1 EXHAUST MANIFOLD HEAT INSULATOR	*4	EXHAUST MANIFOLD TO HEAD GASKET
	N*m (kgf*cm, ft.*lbf): Specified torque	•	Non-reusable part

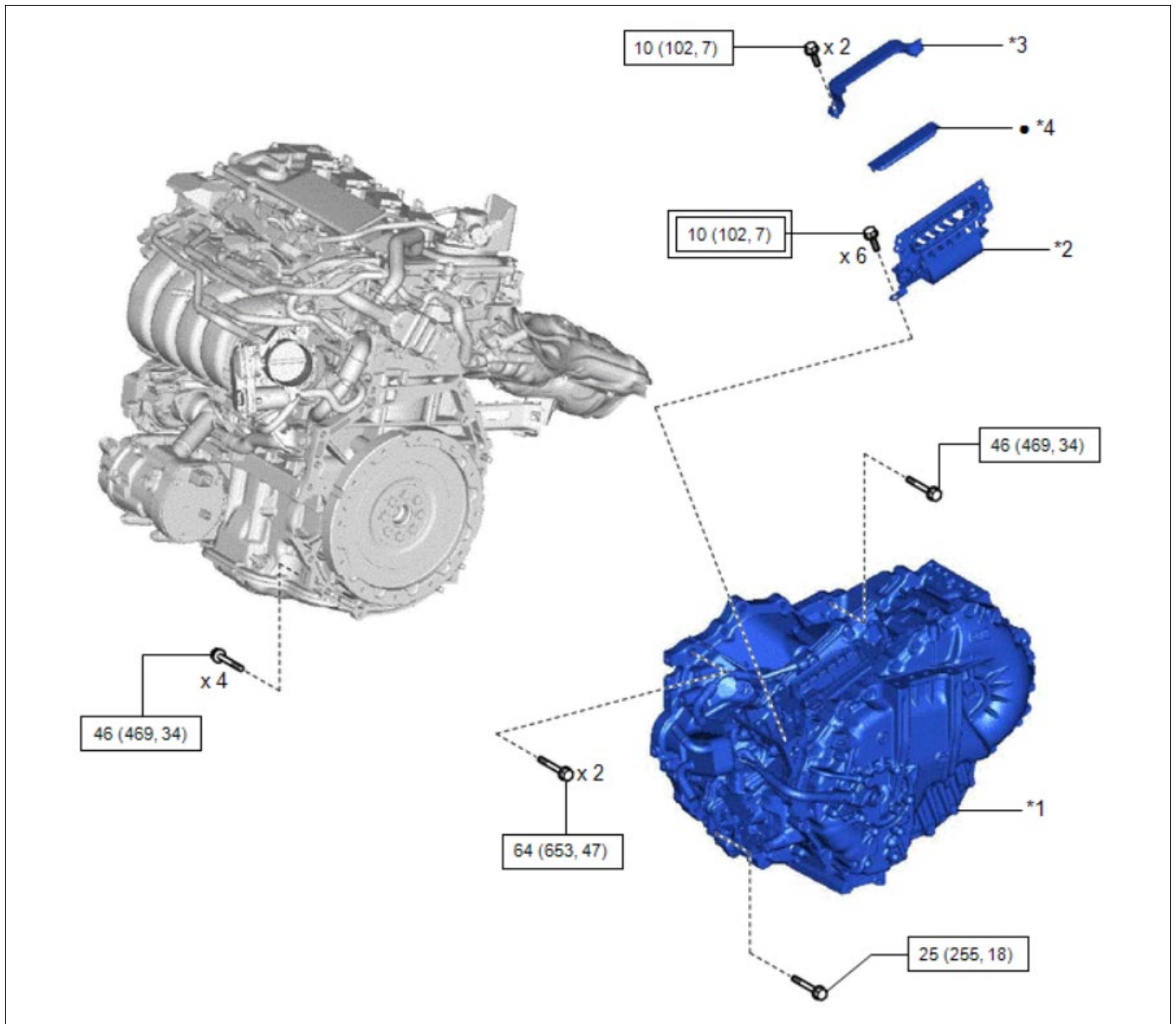

*1	HYBRID VEHICLE TRANSAXLE ASSEMBLY	*2	MOTOR CABLE
*3	CONNECTOR COVER	*4	TERMINAL CAP
	Tightening torque for "Major areas involving basic vehicle performance such as moving/turning/stopping": N*m (kgf*cm, ft.*lbf)		N*m (kgf*cm, ft.*lbf): Specified torque
•	Non-reusable part	-	-

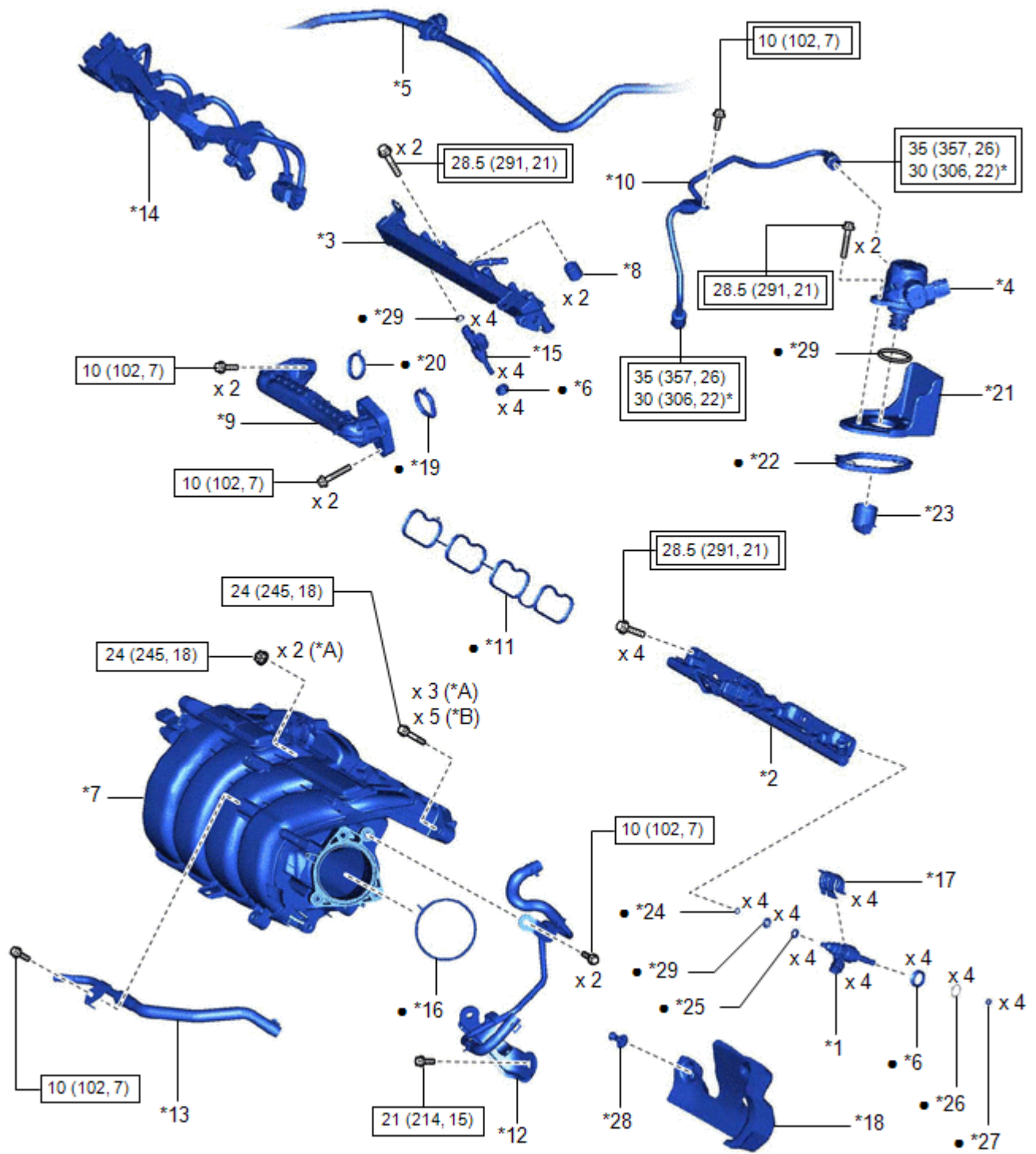

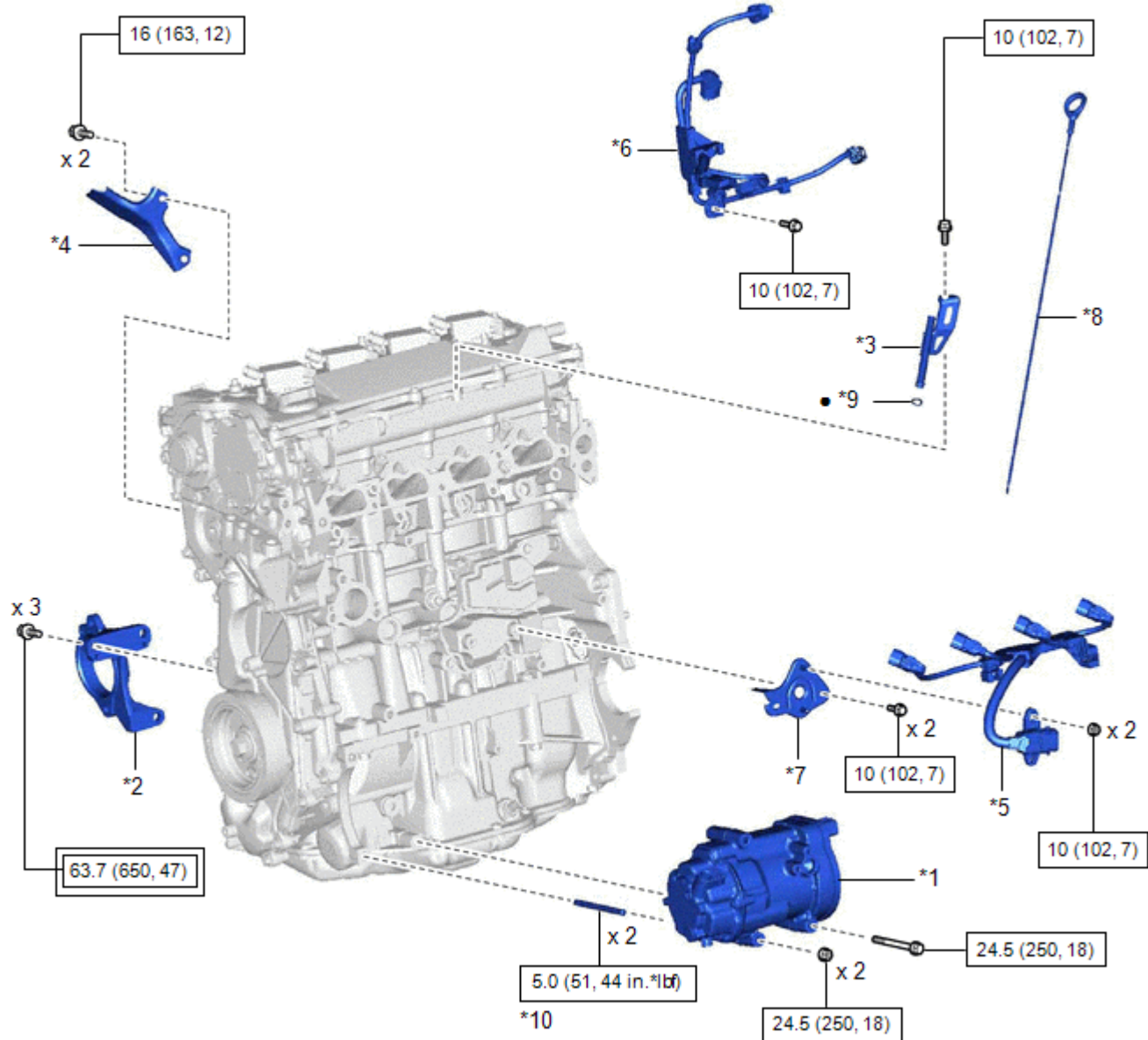

(Diagram detail on next page)

*A	w/ Stud Bolt	*B	w/o Stud Bolt
*1	DIRECT FUEL INJECTOR ASSEMBLY	*2	FUEL DELIVERY PIPE
*3	FUEL DELIVERY PIPE SUB-ASSEMBLY	*4	FUEL PUMP ASSEMBLY (for High Pressure)
*5	FUEL TUBE SUB-ASSEMBLY	*6	INJECTOR VIBRATION INSULATOR
*7	INTAKE MANIFOLD	*8	NO. 1 DELIVERY PIPE SPACER
*9	NO. 1 EGR PIPE SUB-ASSEMBLY	*10	NO. 1 FUEL PIPE SUB-ASSEMBLY
*11	NO. 1 INTAKE MANIFOLD TO HEAD GASKET	*12	NO. 2 WATER BY-PASS PIPE
*13	NO. 3 WATER BY-PASS PIPE	*14	NO. 5 ENGINE WIRE
*15	PORT FUEL INJECTOR ASSEMBLY	*16	THROTTLE BODY GASKET
*17	NOZZLE HOLDER CLAMP	*18	NO. 3 ENGINE COVER
*19	EGR VALVE ADAPTER GASKET	*20	EGR INLET GASKET
*21	FUEL PUMP FLANGE	*22	FUEL PUMP SPACER GASKET
*23	FUEL PUMP LIFTER ASSEMBLY	*24	NO. 3 FUEL INJECTOR BACK-UP RING
*25	NO. 1 FUEL INJECTOR BACK-UP RING	*26	C-RING
*27	FUEL INJECTOR SEAL	*28	CLIP
*29	O-RING	-	-
	Tightening torque for "Major areas involving basic vehicle performance such as moving/turning/stopping": N*m (kgf*cm, ft.*lbf)		N*m (kgf*cm, ft.*lbf): Specified torque
*	For use with a union nut wrench	•	Non-reusable part



(Diagram detail on next page)

*1	COMPRESSOR ASSEMBLY WITH PULLEY	*2	DRIVE SHAFT BEARING BRACKET
*3	ENGINE OIL LEVEL DIPSTICK GUIDE	*4	NO. 3 EXHAUST MANIFOLD HEAT INSULATOR
*5	NO. 6 ENGINE WIRE	*6	SENSOR WIRE
*7	WIRE HARNESS CLAMP BRACKET	*8	ENGINE OIL LEVEL DIPSTICK
*9	O-RING	*10	STUD BOLT
	Tightening torque for "Major areas involving basic vehicle performance such as moving/turning/stopping": N*m (kgf*cm, ft.*lbf)		N*m (kgf*cm, ft.*lbf): Specified torque
•	Non-reusable part	-	-

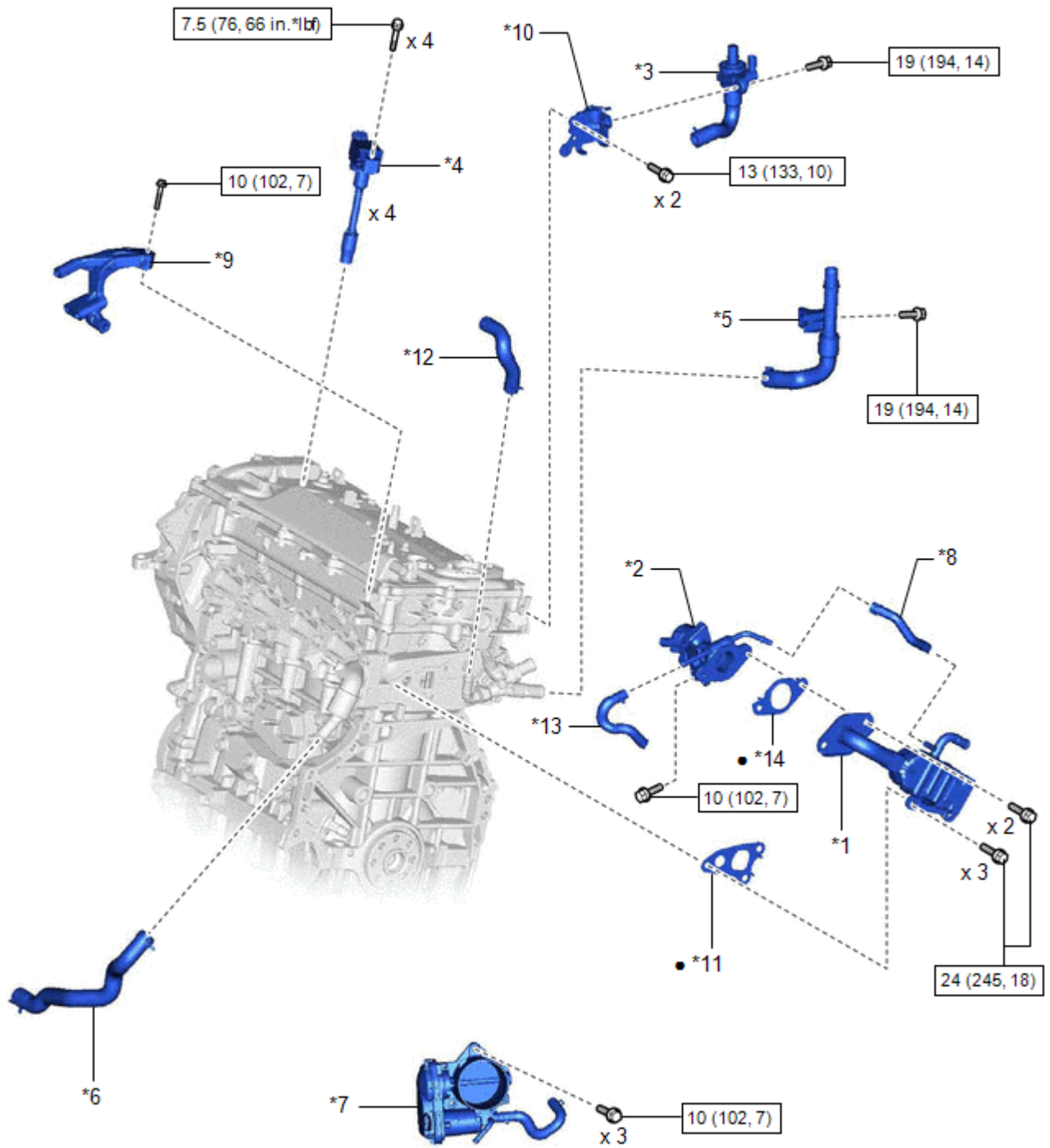

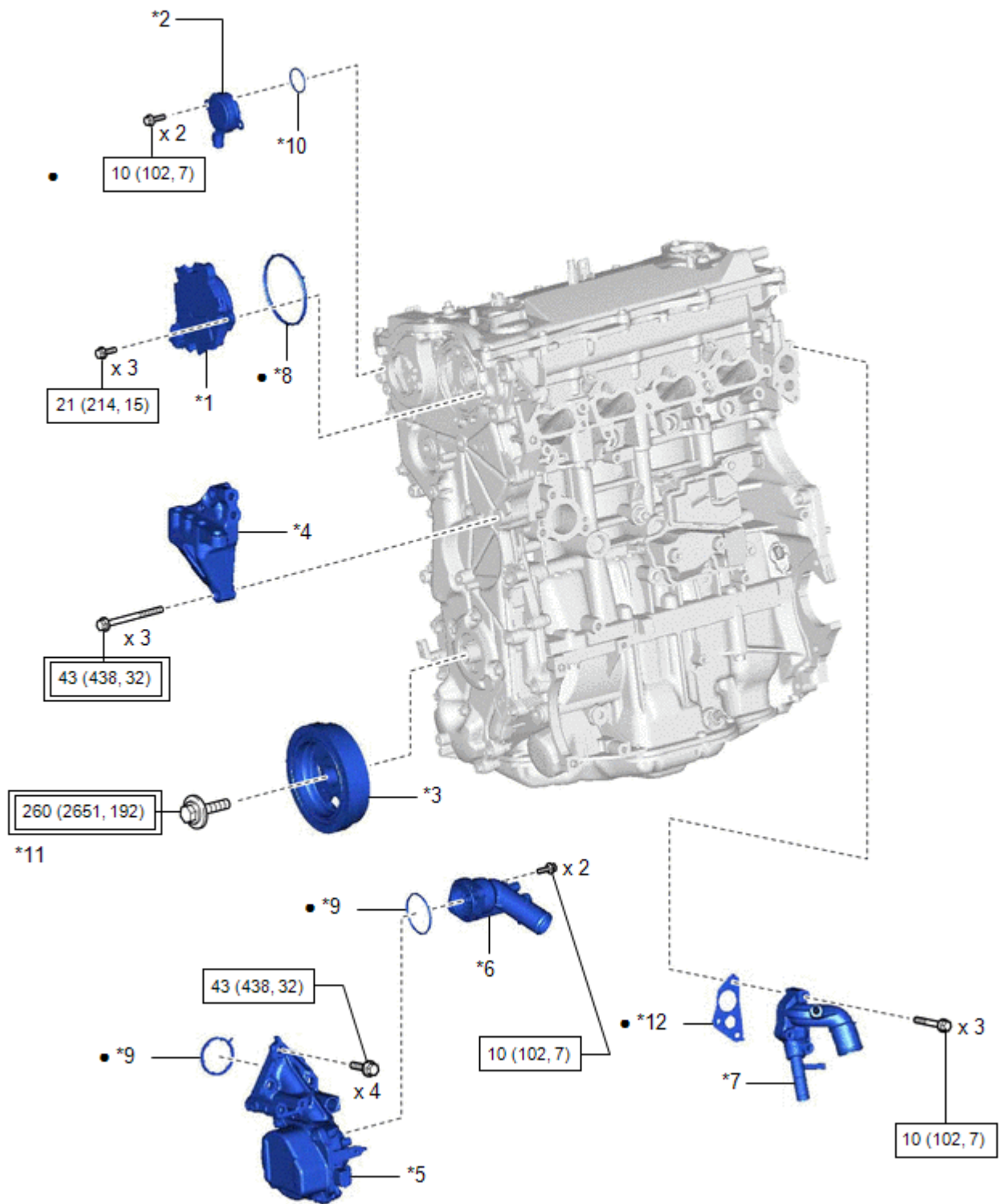

(Diagram detail on next page)

*1	EGR COOLER ASSEMBLY	*2	EGR VALVE ASSEMBLY
*3	FLOW SHUTTING VALVE (WATER BY-PASS HOSE ASSEMBLY)	*4	IGNITION COIL ASSEMBLY
*5	NO. 2 WATER BY-PASS PIPE SUB-ASSEMBLY	*6	NO. 7 WATER BY-PASS HOSE
*7	THROTTLE BODY WITH MOTOR ASSEMBLY	*8	WATER HOSE
*9	EGR VALVE BRACKET	*10	WATER HOSE CLAMP BRACKET
*11	EGR COOLER GASKET	*12	NO. 3 WATER BY-PASS HOSE
*13	NO. 8 WATER BY-PASS HOSE	*14	EGR VALVE GASKET
	N*m (kgf*cm, ft.*lbf): Specified torque	•	Non-reusable part



c

(Diagram detail on next page)

*1	CAM TIMING CONTROL MOTOR WITH EDU ASSEMBLY	*2	CAM TIMING OIL CONTROL SOLENOID ASSEMBLY
*3	CRANKSHAFT PULLEY ASSEMBLY	*4	ENGINE MOUNTING BRACKET RH
*5	ENGINE WATER PUMP ASSEMBLY (WATER INLET HOUSING)	*6	WATER INLET WITH THERMOSTAT SUB-ASSEMBLY
*7	WATER OUTLET	*8	CAM TIMING CONTROL MOTOR O-RING
*9	GASKET	*10	O-RING
*11	CRANKSHAFT PULLEY BOLT	*12	WATER OUTLET GASKET
	Tightening torque for "Major areas involving basic vehicle performance such as moving/turning/stopping": N*m (kgf*cm, ft.*lbf)		N*m (kgf*cm, ft.*lbf): Specified torque
•	Non-reusable part	★	Precoated part

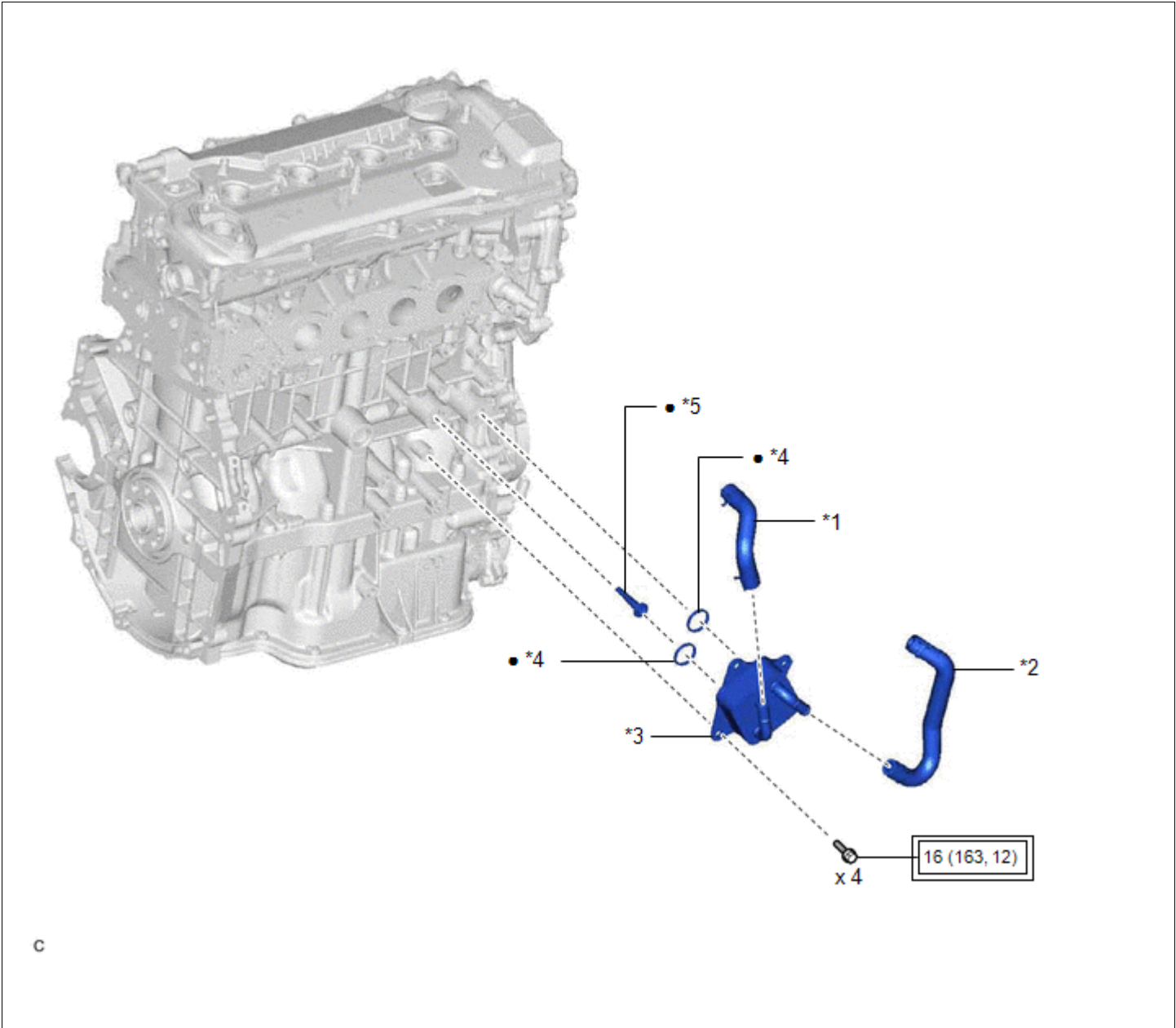

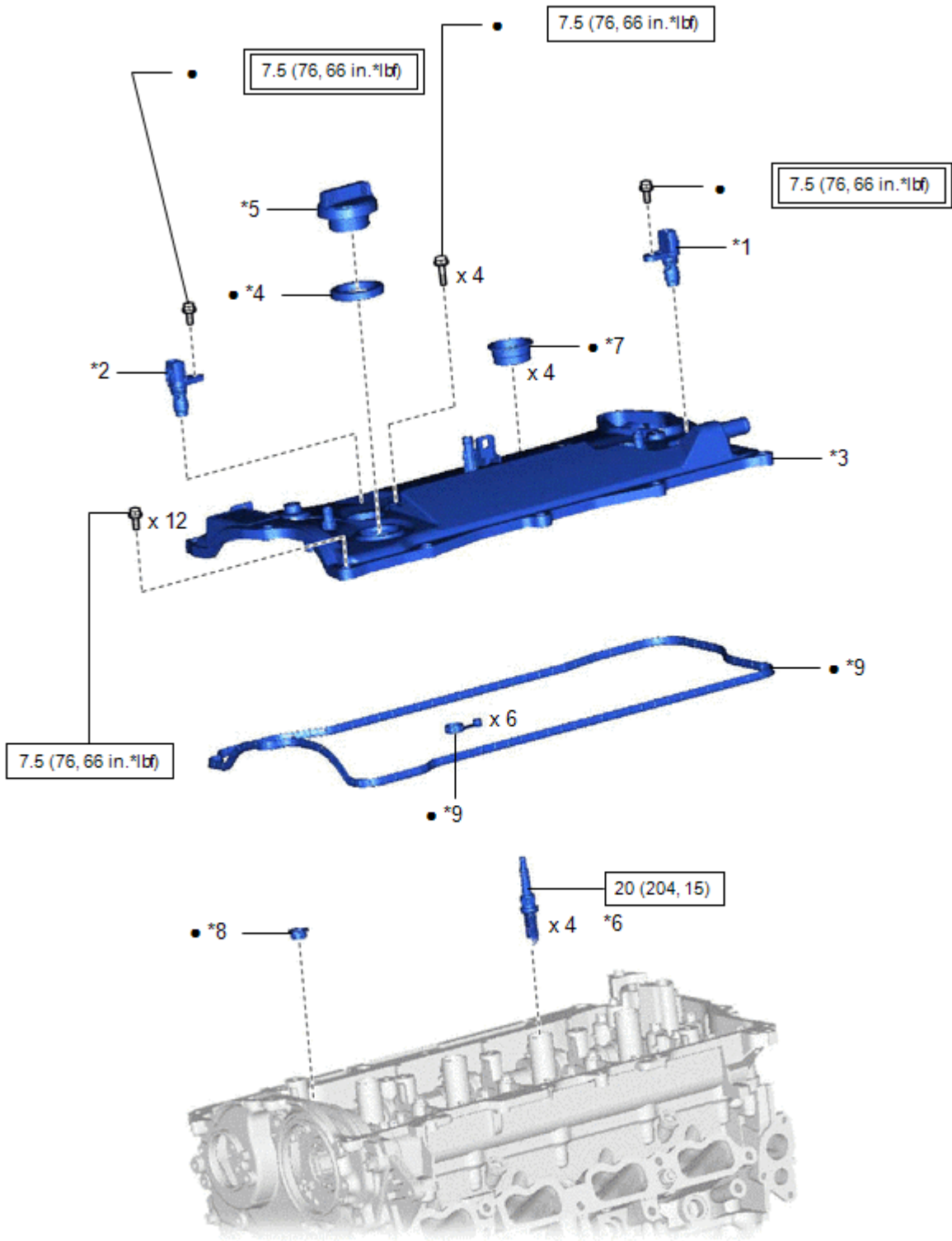

*1	NO. 1 WATER BY-PASS HOSE	*2	NO. 2 WATER BY-PASS HOSE
*3	OIL COOLER ASSEMBLY	*4	OIL COOLER GASKET
*5	OIL CONTROL VALVE FILTER	-	-
	Tightening torque for "Major areas involving basic vehicle performance such as moving/turning/stopping": N*m (kgf*cm, ft.*lbf)	•	Non-reusable part



c

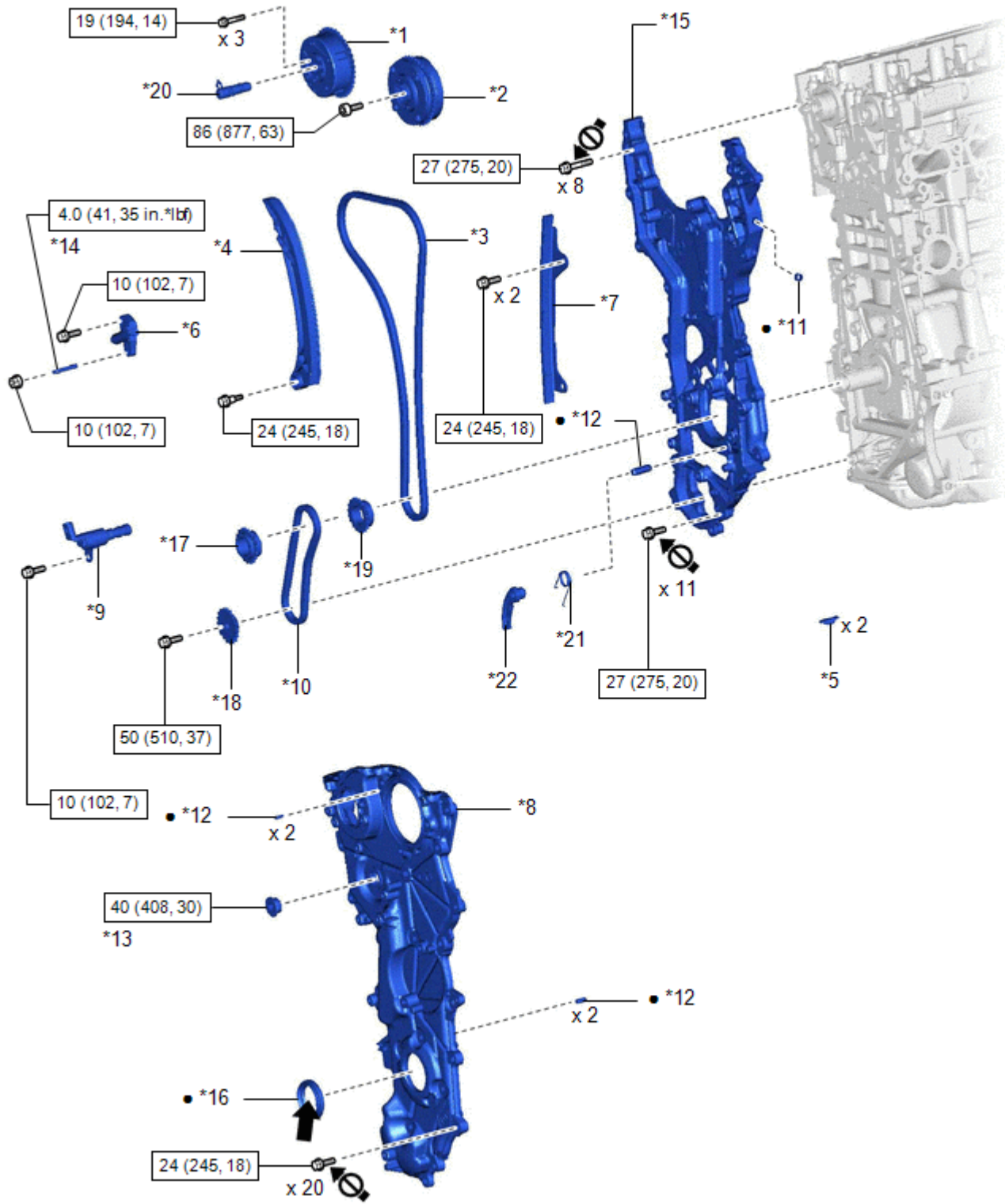

(Diagram detail on next page)

*1	CAMSHAFT POSITION SENSOR (for Intake Side)	*2	CAMSHAFT POSITION SENSOR (for Exhaust Side)
*3	CYLINDER HEAD COVER SUB-ASSEMBLY	*4	OIL FILLER CAP GASKET
*5	OIL FILLER CAP SUB-ASSEMBLY	*6	SPARK PLUG
*7	SPARK PLUG TUBE GASKET	*8	CAMSHAFT BEARING CAP OIL HOLE GASKET
*9	CYLINDER HEAD COVER GASKET	-	-
	Tightening torque for "Major areas involving basic vehicle performance such as moving/turning/stopping": N*m (kgf*cm, ft.*lbf)		N*m (kgf*cm, ft.*lbf): Specified torque
•	Non-reusable part	★	Precoated part





c

(Diagram detail on next page)

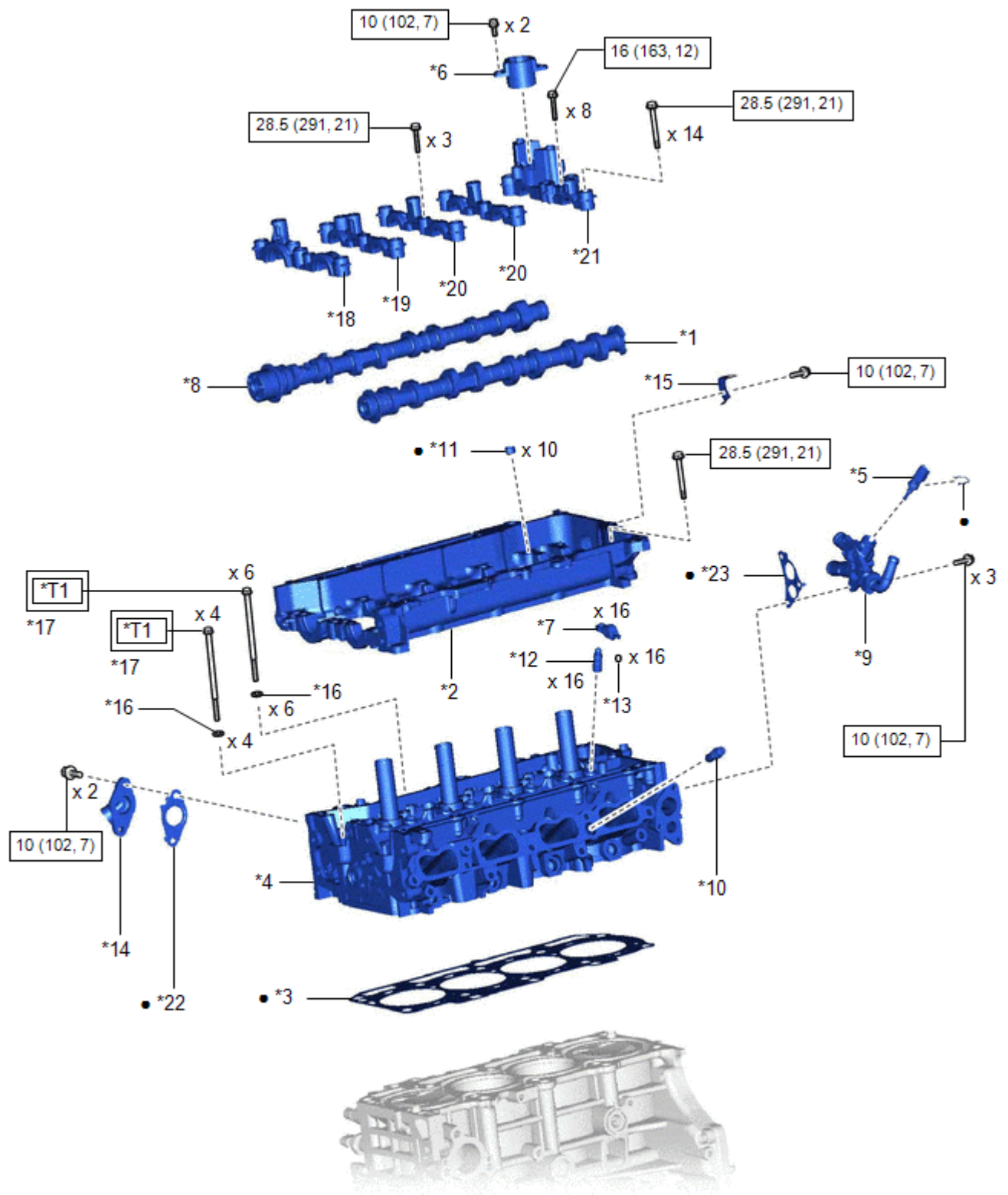
*1	CAMSHAFT TIMING EXHAUST GEAR ASSEMBLY	*2	CAMSHAFT TIMING GEAR ASSEMBLY
*3	CHAIN SUB-ASSEMBLY	*4	CHAIN TENSIONER SLIPPER
*5	CRANKSHAFT TIMING GEAR KEY	*6	NO. 1 CHAIN TENSIONER ASSEMBLY
*7	NO. 1 CHAIN VIBRATION DAMPER	*8	NO. 2 TIMING CHAIN COVER ASSEMBLY
*9	OIL PRESSURE CONTROL VALVE ASSEMBLY	*10	OIL PUMP DRIVE CHAIN SUB-ASSEMBLY
*11	RING PIN	*12	STRAIGHT PIN
*13	STRAIGHT SCREW PLUG	*14	STUD BOLT
*15	TIMING CHAIN COVER ASSEMBLY	*16	TIMING CHAIN COVER OIL SEAL
*17	OIL PUMP DRIVE SPROCKET	*18	OIL PUMP DRIVE SHAFT SPROCKET
*19	CRANKSHAFT TIMING SPROCKET	*20	CAMSHAFT TIMING OIL CONTROL VALVE ASSEMBLY (EXHAUST CAMSHAFT TIMING GEAR BOLT ASSEMBLY)
*21	CHAIN DAMPER SPRING	*22	CHAIN TENSIONER PLATE
	N*m (kgf*cm, ft.*lbf): Specified torque	•	Non-reusable part
	MP grease		Do not apply lubricants to the threaded parts





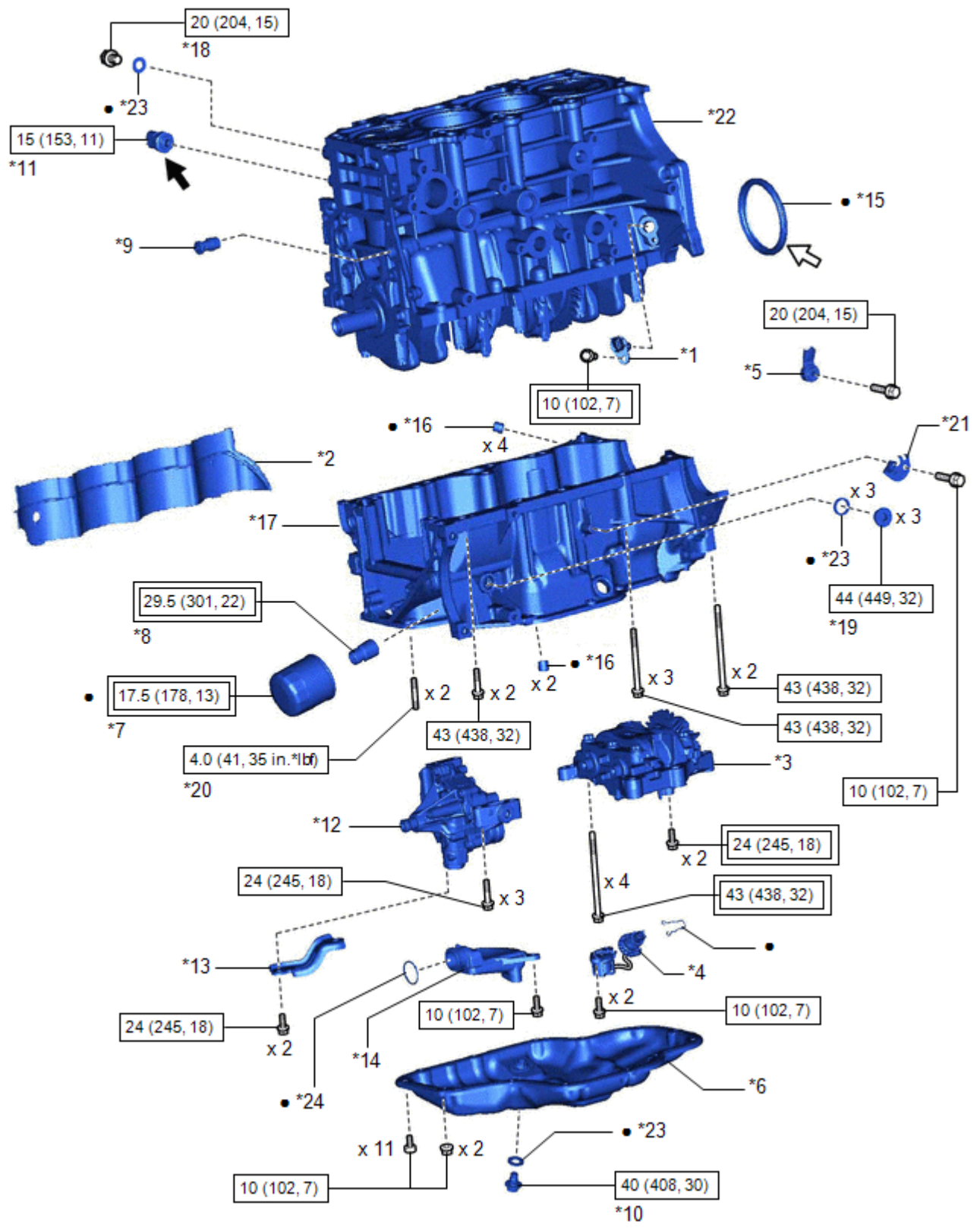

(Diagram detail on next page)

*1	CAMSHAFT	*2	CAMSHAFT HOUSING SUB-ASSEMBLY
*3	CYLINDER HEAD GASKET	*4	CYLINDER HEAD SUB-ASSEMBLY
*5	ENGINE COOLANT TEMPERATURE SENSOR	*6	FUEL PUMP LIFTER GUIDE
*7	NO. 1 VALVE ROCKER ARM SUB-ASSEMBLY	*8	NO. 2 CAMSHAFT
*9	OUTLET WATER BY-PASS SUB-ASSEMBLY	*10	PCV VALVE (VENTILATION VALVE SUB-ASSEMBLY)
*11	RING PIN	*12	VALVE LASH ADJUSTER ASSEMBLY
*13	VALVE STEM CAP	*14	WATER BY-PASS PIPE SUB-ASSEMBLY
*15	WIRE HARNESS CLAMP BRACKET	*16	PLATE WASHER
*17	CYLINDER HEAD SET BOLT	*18	NO. 1 CAMSHAFT BEARING CAP
*19	NO. 2 CAMSHAFT BEARING CAP	*20	NO. 3 CAMSHAFT BEARING CAP
*21	NO. 4 CAMSHAFT BEARING CAP	*22	GASKET
*23	OUTLET WATER PIPE GASKET	-	-
	Tightening torque for "Major areas involving basic vehicle performance such as moving/turning/stopping": N*m (kgf*cm, ft.*lbf)		N*m (kgf*cm, ft.*lbf): Specified torque
•	Non-reusable part	-	-
*T1	1st: 90 (918, 66) 2nd: Turn 90° 3rd: Turn 90°	-	-



P

(Diagram detail on next page)

*1	CRANKSHAFT POSITION SENSOR	*2	CYLINDER BLOCK WATER JACKET SPACER
*3	ENGINE BALANCER ASSEMBLY	*4	ENGINE OIL LEVEL SENSOR
*5	KNOCK CONTROL SENSOR	*6	NO. 2 OIL PAN SUB-ASSEMBLY
*7	OIL FILTER SUB-ASSEMBLY	*8	OIL FILTER UNION
*9	OIL NOZZLE VALVE SUB-ASSEMBLY	*10	OIL PAN DRAIN PLUG
*11	OIL PRESSURE AND TEMPERATURE SENSOR	*12	OIL PUMP ASSEMBLY
*13	OIL PUMP BRACKET	*14	OIL STRAINER SUB-ASSEMBLY
*15	REAR ENGINE OIL SEAL	*16	RING PIN
*17	STIFFENING CRANKCASE ASSEMBLY	*18	STRAIGHT SCREW PLUG
*19	STRAIGHT SCREW PLUG	*20	STUD BOLT
*21	WIRE HARNESS CLAMP BRACKET	*22	CYLINDER BLOCK SUB-ASSEMBLY
*23	GASKET	*24	OIL STRAINER GASKET
	Tightening torque for "Major areas involving basic vehicle performance such as moving/turning/stopping": N*m (kgf*cm, ft.*lbf)		N*m (kgf*cm, ft.*lbf): Specified torque
•	Non-reusable part		Adhesive 1344
	MP grease	★	Precoated part

VII. BLOCK ID No. INSPECTION

1. REMOVE CENTER No. 4 ENGINE UNDER COVER

- Raise the car on a lift to gain access to the bottom of the vehicle.
- Remove the 4 screws to remove the Center No. 4 Engine Under Cover below the engine oil pan.

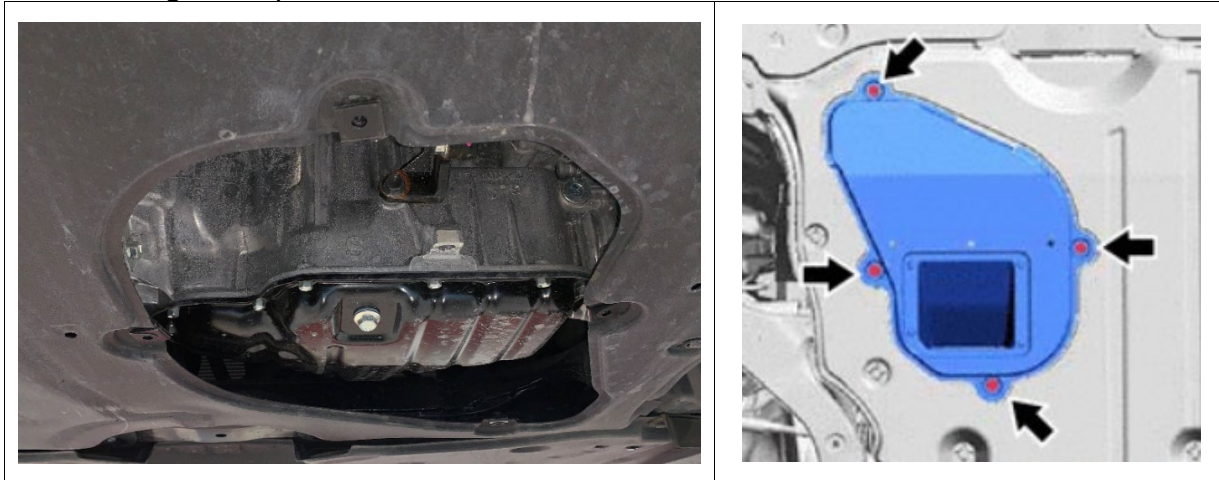

2. LOCATE ENGINE BLOCK ID No.

- Reference the photo below to locate the Block ID No. stamping.
- Use a clean, wet rag to wipe clean the area of the stamping.

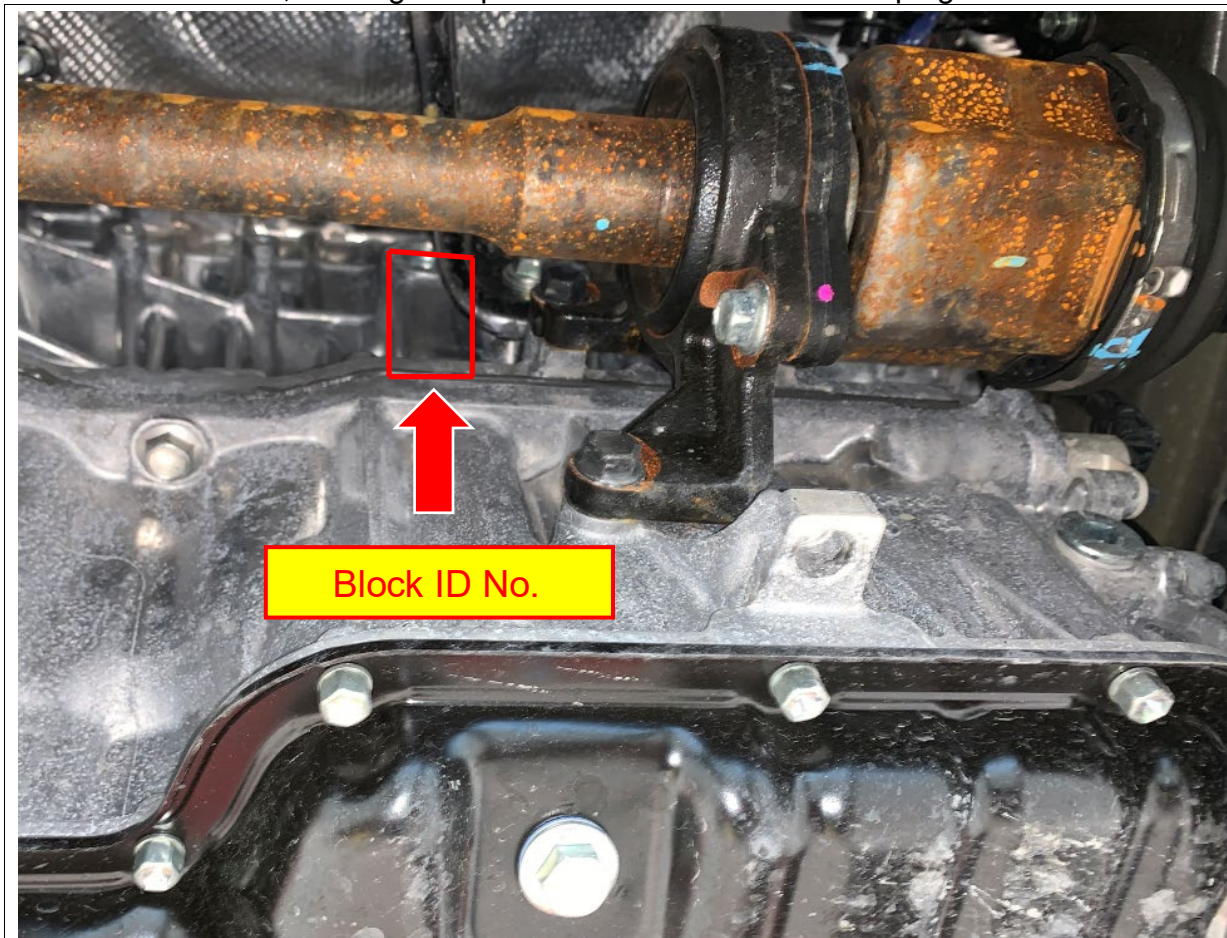

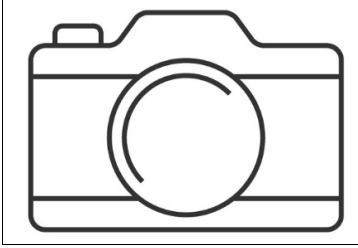

3. TAKE A PHOTO OF THE BLOCK ID No.

- a. Use a camera to take a photo of the Block ID No. Be sure to place the camera as straight and level as possible to the surface of the stamping.



4. REVIEW PHOTO

- a. Zoom in on the Block ID No. in the photo to be sure all 12 characters can be clearly read. If all 12 digits are not legible, retake the photo.

Note: If Necessary, clean the area with a wire brush to remove any dirt and corrosion.

Note: If the Block ID No. is unreadable after properly cleaning the surface and retaking the photos, send an email to Quality Compliance:

Email address: Quality_Compliance@Toyota.com

Subject: Block ID Unreadable

Provide the following:

- **Attachment: Quality photo of the Block ID No.**
- **Dealer Code**
- **Technician Name**
- **VIN #**
- **Explanation of the problem**

Once this email has been sent, please wait for an email response from Quality Compliance. They will provide directions for your next step.

5. OPEN INSPECTION WEBSITE

- a. Open the 20TA04 Inspection Website by selecting the following link:

<https://20TA04-20LA02-safety-recall.imagespm.info/>

- b. Enter your dealer code in the User ID field.
- c. Enter xxxxx for the Password. It will then prompt you to change the password. You can enter the same (5 x's) again, or create your own password. If you do change the password, be sure to advise other technicians of the updated password.

Note: Selecting the "Forgot Password" link will reset the password to the default password: xxxxx

- d. Enter the vehicles VIN. It is critical that the VIN be entered accurately.

6. ENTER BLOCK ID No.

a. Enter the top row of the Block ID No. (6 digits) when prompted.

NOTE: All 6 digits are NUMBERS.



b. Enter the bottom row of the Block ID No. (6 digits) when prompted.

NOTE: The first digit is a LETTER, the remaining digits are NUMBERS.

A screenshot of a web form titled "Image Upload". It contains a text input field for "VIN:" and a "Block ID Number:" field with a "Choose File" button and "No file chosen" text. A "Submit" button is at the bottom.

7. UPLOAD PHOTO

a. The website will require a photo of the Block ID No. to be uploaded. Be sure that all 12 digits of the Block ID No. are legible in the photo.

8. REVIEW INSPECTION RESULTS

a. Review the results provided by the website after inputting the Block ID No.

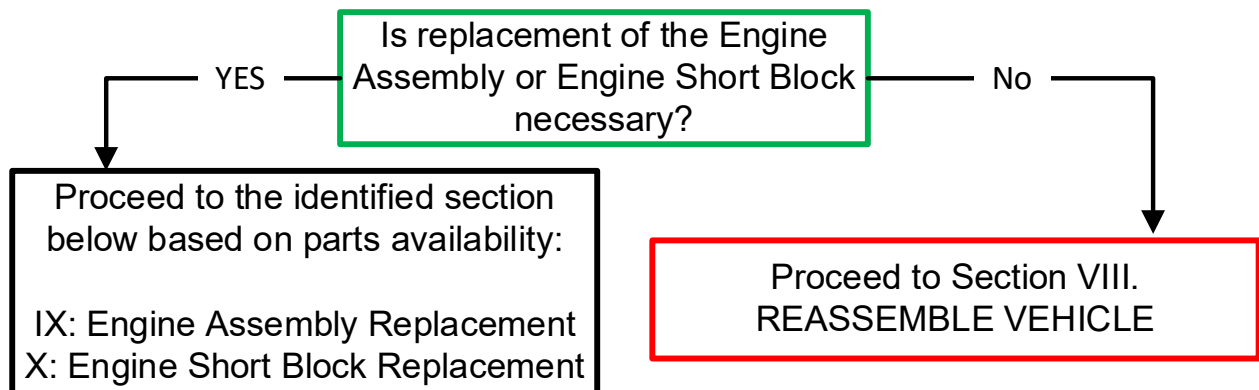

VIII. REASSEMBLE VEHICLE (Engine Replacement NOT Necessary)

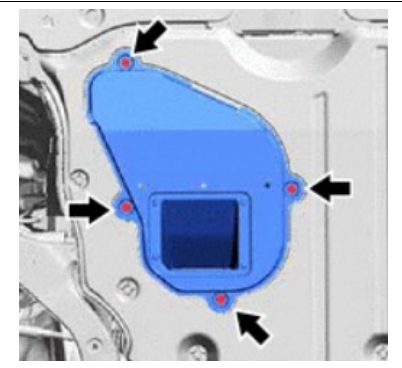

1. **INSTALL CENTER No. 4 ENGINE UNDER COVER**
 - a. Install the center No. 4 engine under cover with the 4 screws.

The Campaign is now complete. Return the vehicle to the customer.

IX. ENGINE ASSEMBLY REPLACEMENT

Engine Assembly Replacement is necessary ONLY if directed by the inspection website and an Engine Assembly IS available.

DO NOT perform this procedure unless directed.

CAUTION:

- Before inspecting the high-voltage system or disconnecting the low voltage connector of the inverter with converter assembly or electric vehicle charger assembly, take safety precautions such as wearing insulated gloves and removing the service plug grip to prevent electrical shocks. After removing the service plug grip, put it in your pocket to prevent other technicians from accidentally reconnecting it while you are working on the high-voltage system.
- After removing the service plug grip, wait for at least 10 minutes before touching any of the high voltage connectors or terminals. After waiting for 10 minutes, check the voltage at the terminals in the inspection point in the inverter with converter assembly. The voltage should be 0 V before beginning work.
- Wait for at least 10 minutes is required to discharge the high-voltage capacitor inside the inverter with converter assembly and electric vehicle charger assembly.



Failure to comply with the following glove inspection procedures could result in serious bodily injury or death as a result from high voltage electrocution.



1. **CHECK HIGH VOLTAGE SERVICE GLOVES**
 - a. Obtain the proper size (M, L, XL) High Voltage Service Gloves with from drawer #6 of the TOYOTA HEV WORKSTATION. Slide the drawer (release in the lower right) out to access the gloves located behind the HV Battery Charger.



Electrical protective equipment shall be maintained in a safe, reliable condition. These gloves should be stored to protect them from light, temperature extremes, excessive humidity, ozone, and other damaging substances and conditions. If needed, the gloves can be cleaned as needed to remove foreign substances.



- b. Remove the leather outer protective glove (left and right) to expose the rubber High Voltage Service Gloves.
- c. Check the Date of Test stamped on the gloves. This indicates the date of the gloves most recent **Certified electrical inspection**. If the date on the gloves is more than 6 months ago, do not use these gloves. They will either need to be replaced or sent to a Certified Testing Facility for recertification to comply with **OSHA standard 1910.137**. An internet search for High Voltage Glove Testing should assist in finding a company to recertify your gloves. For replacement gloves, contact Bosch/OTC at 1-800-933-8335:

Insulated Glove Set, Size M	01413-00072
Insulated Glove Set, Size L	01413-00073
Insulated Glove Set, Size XL	01413-00074



Rubber insulating gloves should always be used with the outer leather protector gloves in place. If the rubber insulator gloves are used without the protective leather gloves, the rubber insulative gloves need to be retested.



- d. Before each daily use and immediately after any incident that may have caused damage, the gloves must be physically inspected. Using the Glove Inflator found in drawer #2 of the TOYOTA HEV WORKSTATION, inflate each glove and inspect for:

- Air leaks
- Holes, tears, punctures or cuts
- Ozone cutting or ozone checking
- Embedded foreign objects, texture changes, including swelling, softening, hardening, or becoming sticky or inelastic
- Any other defect that damages the insulating properties.

Gloves with any of the above defects shall be removed from service or returned for testing.

- e. Reinstall the outer protective leather covers (gloves) over the rubber High Voltage glove to prevent damage.

2. REMOVE SERVICE PLUG

- a. Follow the Repair Manual Process to remove the High Voltage Service Plug.

[HYBRID / BATTERY CONTROL: SERVICE PLUG GRIP: REMOVAL; 2019 MY RAV4 HV](#)

3. REMOVE ENGINE & TRANSMISSION FROM VEHICLE

- a. Follow the Repair Manual Process to remove the engine from the vehicle.

2019: [A25A-FXS \(ENGINE MECHANICAL\): ENGINE ASSEMBLY: REMOVAL; 2019 MY RAV4 HV](#)

2020: [A25A-FXS \(ENGINE MECHANICAL\): ENGINE ASSEMBLY: REMOVAL; 2020 MY RAV4 HV](#)

4. UPDATE ENGINE SERIAL NUMBER

- a. Send an email to quality_compliance@toyota.com with the following information:

- Subject: 20TA04 Engine Serial Number Update
- Vehicle Identification Number (VIN)
- Serial Number from the ORIGINAL engine
- Serial Number from the **NEW** engine

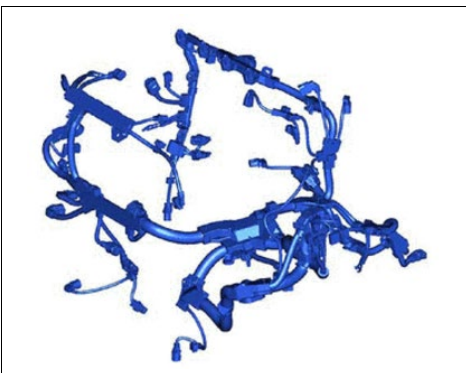
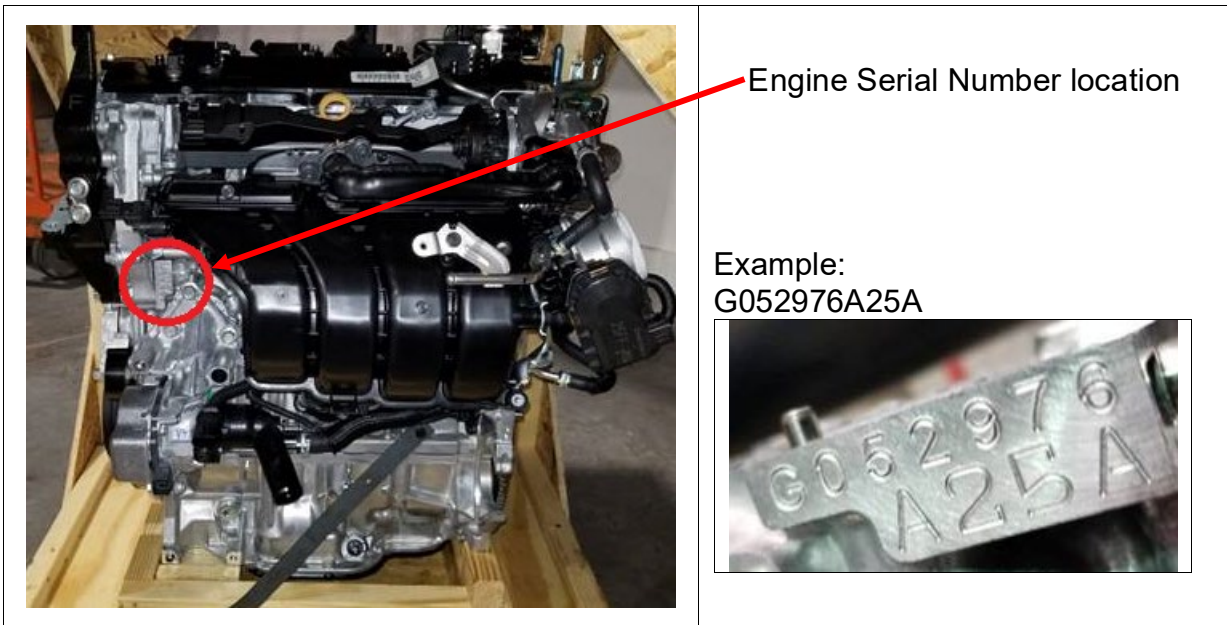

5. REMOVE ENGINE MAIN HARNESS

- a. Remove the engine main harness from the original engine.

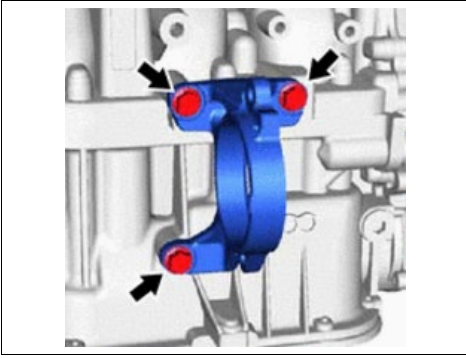

6. TRANSFER DRIVE SHAFT BEARING BRACKET

- a. Remove the 3 bolts and drive shaft bearing bracket from the original engine.
- b. Install the drive shaft bearing bracket and 3 bolts onto the **NEW** engine.

Torque: 47 lbf.ft {63.7 N·m, 650 kgf·cm}

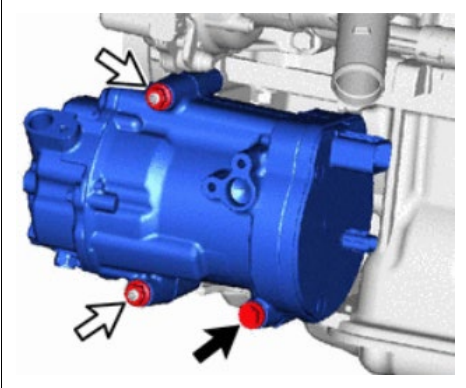

7. TRANSFER COMPRESSOR ASSEMBLY

- a. Remove the bolt and 2 nuts from the original engine.

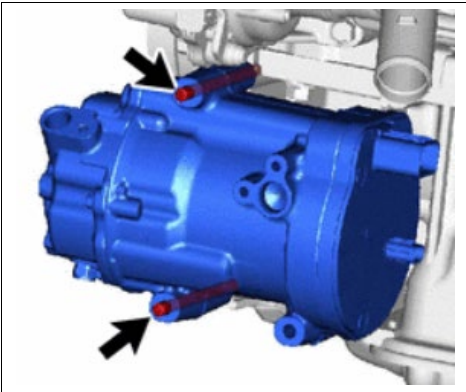

- b. Using a E8 “TORX” wrench, remove the 2 stud bolts and compressor assembly.
- c. Install the 2 stud bolts onto the **NEW** engine.

Torque: 7 lbf.ft {10 N·m, 102 kgf·cm}

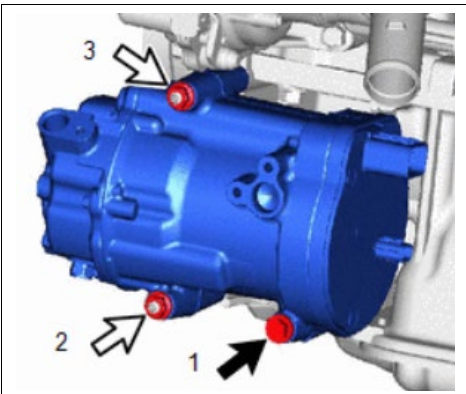

- d. Install the compressor assembly onto the **NEW** engine with the bolt and 2 nuts. Torque in the sequence shown.

Torque: 18 lbf.ft {24.5 N·m, 250 kgf·cm}

Note: Tighten the bolt and nuts in the order shown in the illustration

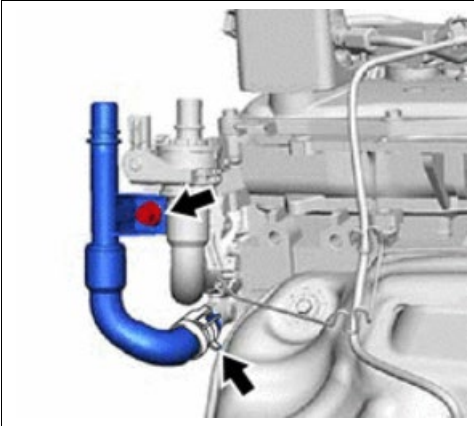

- 8. TRANSFER NO. 2 WATER BY-PASS PIPE**
- Remove the bracket bolt from the original engine.
 - Slide the clamp and remove the hose.
 - Install the hose and clamp onto the **NEW** engine.
 - Install the bracket bolt.

Torque: 14 lbf.ft {19 N·m, 194 kgf·cm}

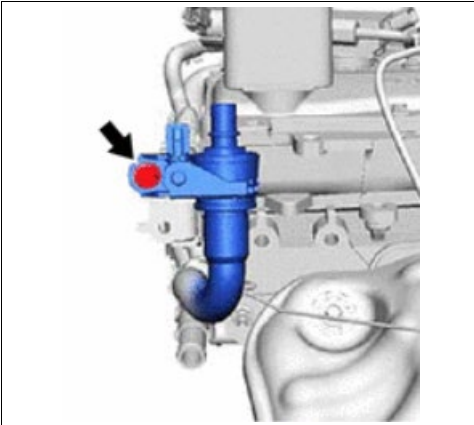

- 9. TRANSFER FLOW SHUTTING VALVE**
- Remove the bolt from the original engine.

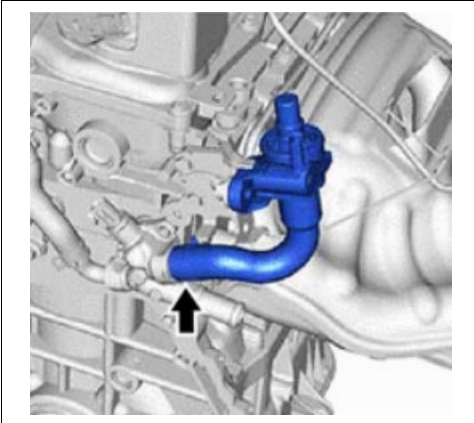

- Slide the clip and disconnect the flow shutting valve from the water by-pass outlet.

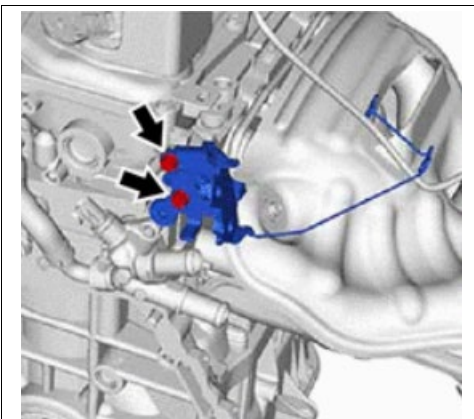

- Remove the 2 bolts and the water hose bracket.
- Install the bracket onto the **NEW** engine with the 2 bolts.

Torque: 10 lbf.ft {13 N·m, 133 kgf·cm}

- Connect the flow shutting valve to the water by-pass outlet and slide the clip to secure it.
- Install the valve to the bracket.

Torque: 14 lbf.ft {19 N·m, 194 kgf·cm}



10. TRANSFER EXHAUST MANIFOLD

- a. Remove the 5 bolts from the heat insulator.
- b. Remove the manifold stay on the bottom.
- c. Using a 12mm deep socket, remove the 7 nuts and separate the exhaust manifold.

Note: Discard the 7-exhaust manifold nut's as they will not be reused.

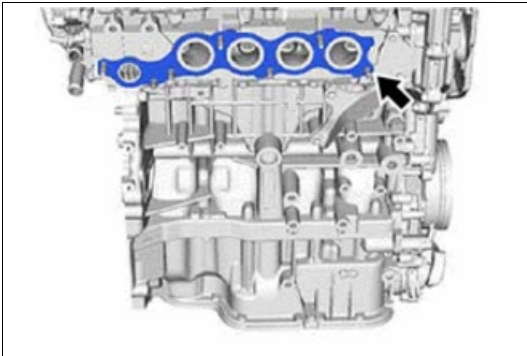

- d. Install a **NEW** exhaust manifold gasket onto the **NEW** engine.

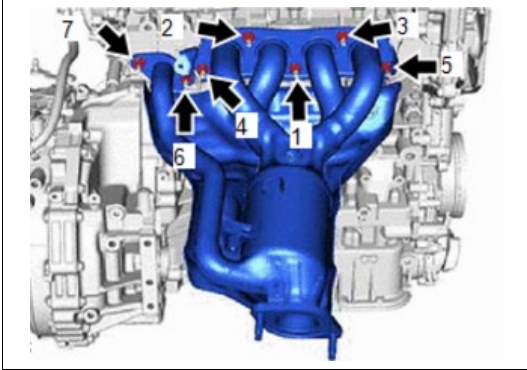

- e. Install the exhaust manifold onto the **NEW** engine.
- f. Temporarily install the 7 **NEW** nuts onto the studs.
- g. Using a 12mm deep socket, torque the 7 nuts in the sequence shown.

Torque: 19 lbf.ft {26 N·m, 265 kgf·cm}

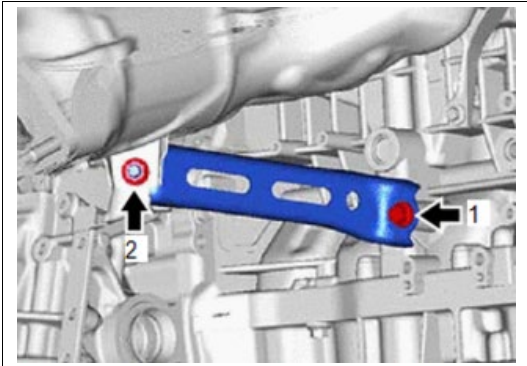

- h. Install the manifold stay and the nut and bolt.
- i. Torque the nut and bolt in the sequence shown

Torque: 32 lbf.ft {43 N·m, 438 kgf·cm}

- j. Install the heat insulator with the 5 bolts.

Torque: 7 lbf.ft {10 N·m, 102 kgf·cm}

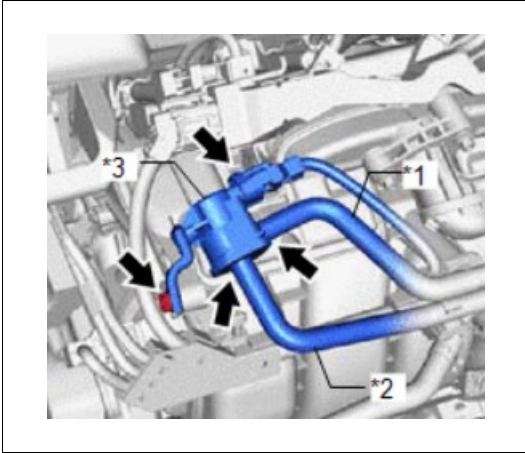

11. TRANSFER PURGE VALVE

- a. Disconnect electrical connector.
- b. Disconnect the 2 fuel vapor feed hoses.
- c. Unbolt the purge valve from the mounting bracket on the original engine.
- d. Install the purge valve on the **NEW** engine, attaching the hoses properly. Install the bolt to the mounting bracket.

Torque: 7 lbf.ft {10 N·m, 102 kgf·cm}

- e. Connect the 2 vapor feed hoses.
- f. Connect the electrical connector.

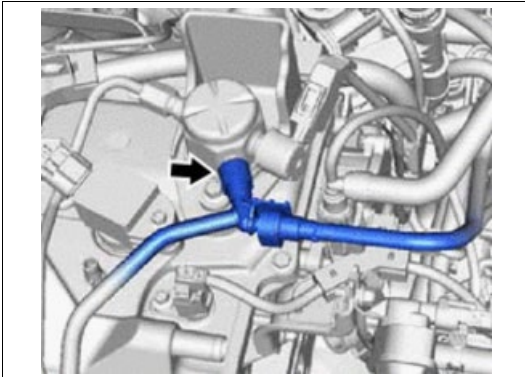

12. TRANSFER FUEL TUBE

- a. Disconnect the fuel tube at the high-pressure fuel pump of the original engine.

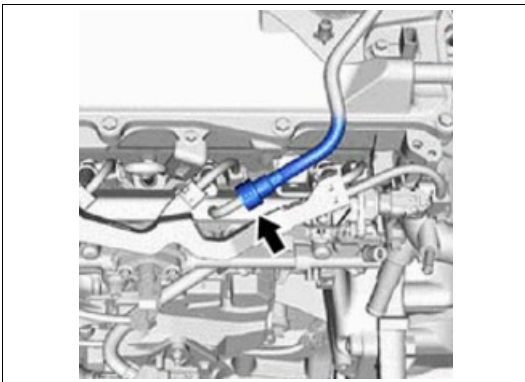

- b. Disconnect the fuel tube at the low-pressure fuel rail of the original engine.
- c. Install the fuel tube to both the low-pressure fuel rail and the high-pressure pump of the **NEW** engine.

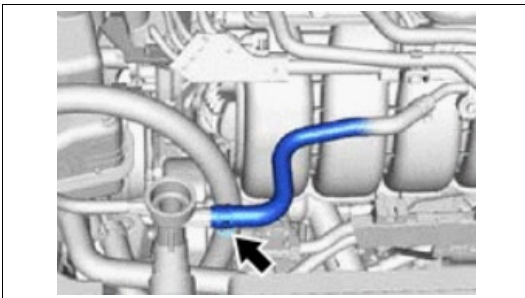

13. TRANSFER No. 5 WATER BYPASS HOSE

- a. Remove the No. 5 water bypass hose from the original engine.
- b. Install the No. 5 water bypass hose onto the **NEW** engine.

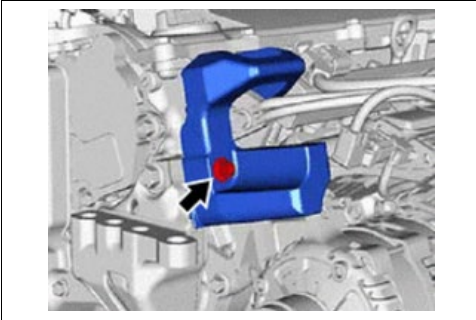

14. TRANSFER FUEL DELIVERY GUARD

- a. Remove the bolt and fuel delivery guard from the original engine.
- b. Install the fuel delivery guard and bolt onto the **NEW** engine.

Torque: 30 lbf.ft {40 N·m, 408 kgf·cm}

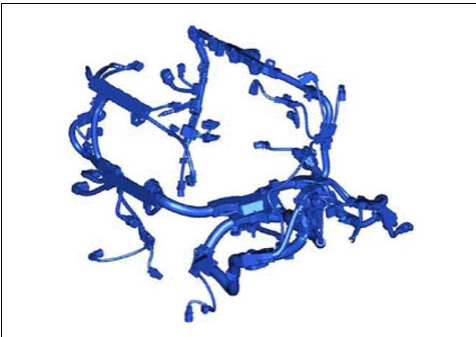

15. INSTALL ENGINE MAIN HARNESS

- a. Install the engine main harness onto the **NEW** engine.

16. REMOVE AUTOMATIC TRANSMISSION ASSEMBLY FROM ORIGINAL ENGINE

- a. Follow the Repair Manual Process to separate the engine and transmission.

2019: [P710 \(HYBRID TRANSMISSION / TRANSAXLE\): HYBRID VEHICLE TRANSAXLE: REMOVAL; 2019 MY RAV4 HV](#)

2020: [P710 \(HYBRID TRANSMISSION / TRANSAXLE\): HYBRID VEHICLE TRANSAXLE: REMOVAL; 2020 MY RAV4 HV](#)

17. INSTALL AUTOMATIC TRANSMISSION ASSEMBLY TO **NEW** ENGINE

- a. Follow the Repair Manual Process to join the **NEW** engine and transmission together

2019 & 2020: [P710 \(HYBRID TRANSMISSION / TRANSAXLE\): HYBRID VEHICLE TRANSAXLE: INSTALLATION; 2019 - 2020 MY RAV4 HV](#)

18. INSTALL **NEW** ENGINE & TRANSMISSION INTO VEHICLE

- a. Follow the Repair Manual Process to install the **NEW** engine into the vehicle.

[A25A-FKS \(ENGINE MECHANICAL\): ENGINE ASSEMBLY: INSTALLATION; 2019 - 2020 MY RAV4](#)

◀ VERIFY REPAIR QUALITY ▶

- Verify all DTC's have been cleared.
- Verify the air cleaner cap and hose are properly installed.
- Verify there are no oil or coolant leaks.
- Test drive the vehicle to confirm normal operation.

If you have any questions regarding this update, please contact your regional representative.

X. ENGINE SHORT BLOCK REPLACEMENT

Engine Short Block Replacement is necessary ONLY if directed by the inspection website and an Engine Assembly IS NOT available.

DO NOT perform this procedure unless directed.

CAUTION:

- Before inspecting the high-voltage system or disconnecting the low voltage connector of the inverter with converter assembly or electric vehicle charger assembly, take safety precautions such as wearing insulated gloves and removing the service plug grip to prevent electrical shocks. After removing the service plug grip, put it in your pocket to prevent other technicians from accidentally reconnecting it while you are working on the high-voltage system.
- After removing the service plug grip, wait for at least 10 minutes before touching any of the high voltage connectors or terminals. After waiting for 10 minutes, check the voltage at the terminals in the inspection point in the inverter with converter assembly. The voltage should be 0 V before beginning work.
- Wait for at least 10 minutes is required to discharge the high-voltage capacitor inside the inverter with converter assembly and electric vehicle charger assembly.



Failure to comply with the following glove inspection procedures could result in serious bodily injury or death as a result from high voltage electrocution.



1. **CHECK HIGH VOLTAGE SERVICE GLOVES**
 - a. Obtain the proper size (M, L, XL) High Voltage Service Gloves with from drawer #6 of the TOYOTA HEV WORKSTATION. Slide the drawer (release in the lower right) out to access the gloves located behind the HV Battery Charger.



Electrical protective equipment shall be maintained in a safe, reliable condition. These gloves should be stored to protect them from light, temperature extremes, excessive humidity, ozone, and other damaging substances and conditions. If needed, the gloves can be cleaned as needed to remove foreign substances.



- b. Remove the leather outer protective glove (left and right) to expose the rubber High Voltage Service Gloves.
- c. Check the Date of Test stamped on the gloves. This indicates the date of the gloves most recent **Certified electrical inspection**. If the date on the gloves is more than 6 months ago, do not use these gloves. They will either need to be replaced or sent to a Certified Testing Facility for recertification to comply with [OSHA standard 1910.137](#). An internet search for [High Voltage Glove Testing](#) should assist in finding a company to recertify your gloves. For replacement gloves, contact Bosch/OTC at 1-800-933-8335:

Insulated Glove Set, Size M	01413-00072
Insulated Glove Set, Size L	01413-00073
Insulated Glove Set, Size XL	01413-00074

 **Rubber insulating gloves should always be used with the outer leather protector gloves in place. If the rubber insulator gloves are used without the protective leather gloves, the rubber insulative gloves need to be retested.**



- d. Before each daily use and immediately after any incident that may have caused damage, the gloves must be physically inspected. Using the Glove Inflator found in drawer #2 of the TOYOTA HEV WORKSTATION, inflate each glove and inspect for:
 - Air leaks
 - Holes, tears, punctures or cuts
 - Ozone cutting or ozone checking
 - Embedded foreign objects, texture changes, including swelling, softening, hardening, or becoming sticky or inelastic
 - Any other defect that damages the insulating properties.

Gloves with any of the above defects shall be removed from service or returned for testing.

- e. Reinstall the outer protective leather covers (gloves) over the rubber High Voltage glove to prevent damage.

2. REMOVE SERVICE PLUG

- a. Follow the Repair Manual Process to remove the High Voltage Service Plug.

[HYBRID / BATTERY CONTROL: SERVICE PLUG GRIP: REMOVAL; 2019 MY RAV4 HV](#)

3. REMOVE ENGINE & TRANSMISSION FROM VEHICLE

- a. Follow the Repair Manual Process to remove the engine from the vehicle.

2019: [A25A-FXS \(ENGINE MECHANICAL\): ENGINE ASSEMBLY: REMOVAL; 2019 MY RAV4 HV](#)

2020: [A25A-FXS \(ENGINE MECHANICAL\): ENGINE ASSEMBLY: REMOVAL; 2020 MY RAV4 HV](#)

4. UPDATE ENGINE SERIAL NUMBER

- a. Send an email to quality_compliance@toyota.com with the following information:

- Subject: 20TA04 Engine Serial Number Update
- Vehicle Identification Number (VIN)
- Serial Number from the ORIGINAL engine
- Serial Number from the **NEW** engine short block

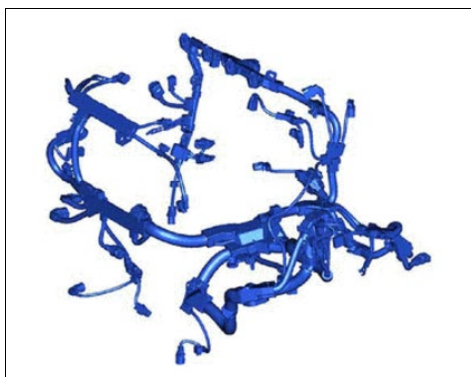
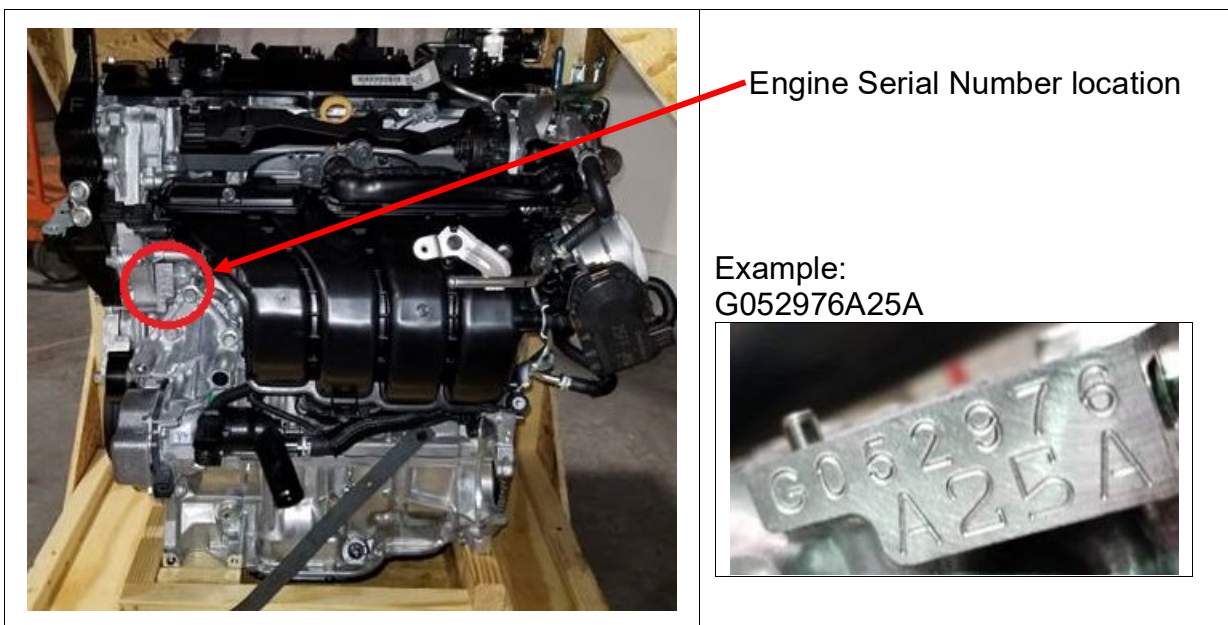

5. REMOVE ENGINE MAIN HARNESS

- a. Remove the engine main harness from the original engine.

6. REMOVE ENGINE UNIT

- a. Follow the Repair Manual Process to remove the engine unit.

2019: [A25A-FXS \(ENGINE MECHANICAL\): ENGINE UNIT: REMOVAL; 2019 MY RAV4 HV](#)

2020: [A25A-FXS \(ENGINE MECHANICAL\): ENGINE UNIT: REMOVAL; 2020 MY RAV4 HV](#)

7. REMOVE AUTOMATIC TRANSMISSION ASSEMBLY FROM **ORIGINAL** ENGINE

- a. Follow the Repair Manual Process to separate the engine and transmission.

2019: [P710 \(HYBRID TRANSMISSION / TRANSAXLE\): HYBRID VEHICLE TRANSAXLE: REMOVAL; 2019 MY RAV4 HV](#)

2020: [P710 \(HYBRID TRANSMISSION / TRANSAXLE\): HYBRID VEHICLE TRANSAXLE: REMOVAL; 2020 MY RAV4 HV](#)

8. DISASSEMBLE ENGINE COMPONENTS FROM **ORIGINAL** SHORT BLOCK

- a. Follow the Repair Manual Process to disassemble the engine unit.

2019: [A25A-FXS \(ENGINE MECHANICAL\): ENGINE UNIT: DISASSEMBLY; 2019 - 2020 MY RAV4 HV](#)

2020: [A25A-FXS \(ENGINE MECHANICAL\): ENGINE UNIT: DISASSEMBLY; 2020 - 2021 MY RAV4 HV](#)

9. REASSEMBLE ENGINE COMPONENTS TO **REPLACEMENT** SHORT BLOCK

- a. Follow the Repair Manual Process to reassemble the engine unit.

[A25A-FXS \(ENGINE MECHANICAL\): ENGINE UNIT: REASSEMBLY; 2019 - 2020 MY RAV4 HV](#)

10. INSTALL AUTOMATIC TRANSMISSION ASSEMBLY TO **REBUILT** ENGINE

- a. Follow the Repair Manual Process to join the **REBUILT** engine and transmission together

[P710 \(HYBRID TRANSMISSION / TRANSAXLE\): HYBRID VEHICLE TRANSAXLE: INSTALLATION; 2019 - 2020 MY RAV4 HV](#)

11. INSTALL ENGINE UNIT

- a. Follow the Repair Manual Process to remove the engine unit.

[A25A-FXS \(ENGINE MECHANICAL\): ENGINE UNIT: INSTALLATION; 2019 - 2020 MY RAV4 HV](#)

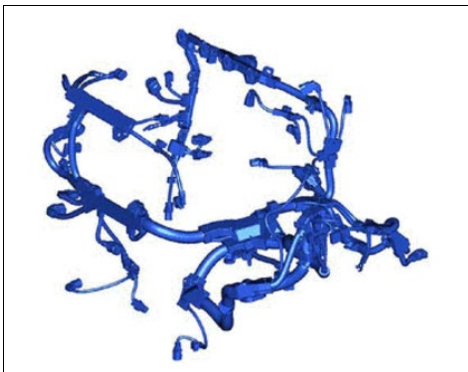

12. INSTALL ENGINE MAIN HARNESS

- a. Install the engine main harness on the **REBUILT** engine.

13. INSTALL **REBUILT** ENGINE & TRANSMISSION INTO VEHICLE

a. Follow the Repair Manual Process to install the **REBUILT** engine into the vehicle.

A25A-FXS (ENGINE MECHANICAL): ENGINE ASSEMBLY: INSTALLATION; 2019 - 2020 MY RAV4 HV

◀ VERIFY REPAIR QUALITY ▶

- Verify all DTC's have been cleared.
- Verify the air cleaner cap and hose are properly installed.
- Verify there are no oil or coolant leaks.
- Test drive vehicle to confirm normal operation.

If you have any questions regarding this update, please contact your area representative.

XI. APPENDIX

A. PARTS DISPOSAL

As required by Federal Regulations, please make sure all recalled parts (original parts) removed from the vehicle are disposed of in a manner in which they will not be reused, **unless requested for parts recovery return.**

