

# TECHNICAL INSTRUCTIONS

FOR

## SAFETY RECALL 20TA02

### VEHICLE MAY STALL DURING DRIVING AT HIGHER SPEED

#### 2017 – 2020 SIENNA MOBILITY VEHICLES

These instructions are only for 20TA02 Sienna vehicles that have been converted for mobility use by an authorized mobility conversion company. All other models are detailed in separate instructions.

The repair quality of covered vehicles is extremely important to Toyota. All dealership technicians performing this recall are required to successfully complete the most current version of the E-Learning course “Safety Recall and Service Campaign Essentials”. To ensure that all vehicles have the repair performed correctly; technicians performing this recall repair are required to currently hold at least one of the following certification levels:

- Certified (any specialty)
- Expert (any specialty)
- Master
- Master Diagnostic Technician

It is the dealership’s responsibility to select technicians with the above certification level or greater to perform this recall repair. Carefully review your resources, the technician skill level, and ability before assigning technicians to this repair. It is important to consider technician days off and vacation schedules to ensure there are properly trained technicians available to perform this repair at all times.

## MOBILITY VEHICLE ELIGIBILITY

### **Are Sienna vehicles that have been converted for wheelchair accessibility able to have the remedy performed?**

Only vehicles that are converted for wheelchair accessibility by a Toyota-authorized mobility conversion company are compatible with the remedy.

### **Who are the authorized mobility conversion companies?**

Below is the list of companies that are authorized by Toyota to convert Sienna vehicles for wheelchair accessibility.

- The Braun Corporation (BraunAbility)
- Vantage Mobility International (VMI)

### **What if a vehicle is converted by a non-authorized mobility conversion company?**

Sienna vehicles that have been converted for wheelchair accessibility by a non-Toyota authorized mobility conversion company have undergone an unauthorized modification to the factory condition of the vehicle. These vehicles may be incompatible with the remedy in their current modified condition. Toyota does not recommend modifying vehicles and cannot evaluate how any aftermarket, non-Toyota approved parts and/or modifications could affect a vehicle's performance.

Notwithstanding Toyota's recommendation, some dealers may be willing to perform the Safety Recall remedy with the vehicle in its current modified condition. If your dealership is willing to do so, the customer may be responsible for the cost of parts and/or labor not otherwise covered by Toyota's Safety Recall. Toyota provides the specific remedy parts, differential oil (AWD-only), and covers 2.6 – 2.7 hours of dealership labor expenses. The customer is responsible to pay any additional charges for parts and/or labor which are the result of the vehicle's non-Toyota-approved modifications.

Toyota is not responsible for later performance problems the vehicle may have that are the result of the non-Toyota-approved vehicle modifications.

# I. OPERATION FLOW CHART

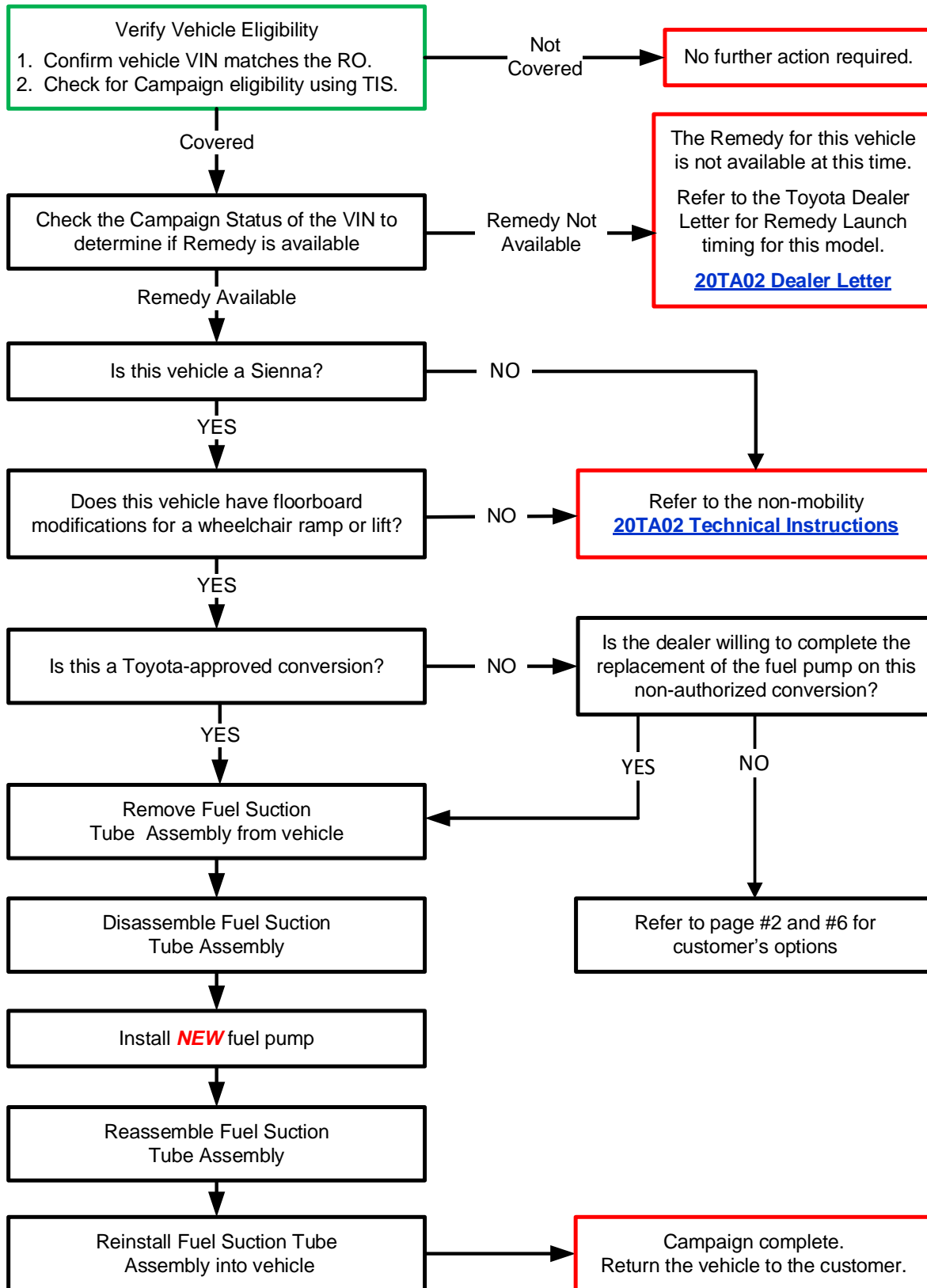

## II. IDENTIFICATION OF AFFECTED VEHICLES

### 1. CHECK VEHICLE FOR CAMPAIGN ELIGIBILITY

- Compare the vehicle's VIN to the VIN listed on the Repair Order to ensure they match.
- Check the TIS Vehicle Inquiry System or Service Lane to verify this vehicle is eligible for Safety Recall 20TA02.
- Determine the **Campaign Status** for Safety Recall 20TA02.

**Campaign Description:** Safety Recall 20TA02 (Remedy Notice), Multiple  
**Campaign Status:** ??????????  
**Completion Status:** **Not Completed**

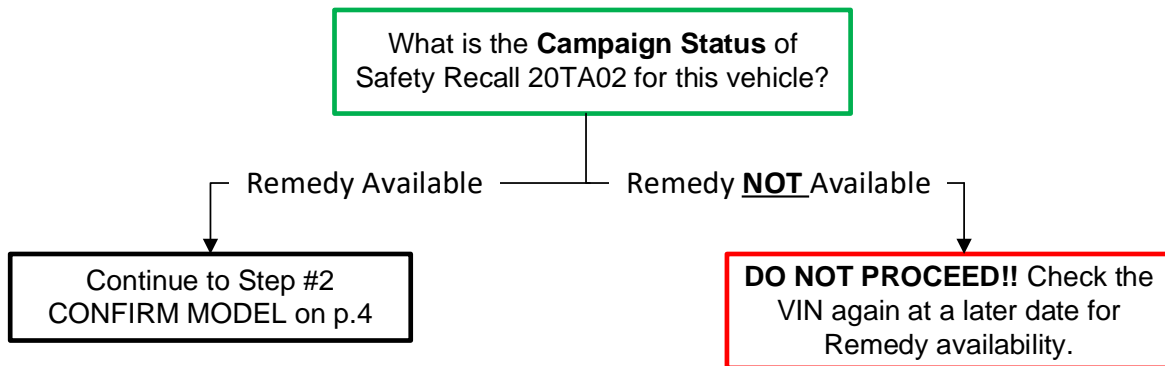

**DO NOT PROCEED with these instructions if the Campaign Status shows Remedy Not Available!**

The remedy for this campaign is being launched in phases. Confirm remedy eligibility on each VIN in TIS before starting any repairs. Launch timing specific to each model is available in the [20TA02 Dealer Letter](#).

Note: Warranty will not reimburse dealers for repairs completed on vehicles that are not affected or were previously completed, even by another dealer. In addition, warranty claims will not be processed for vehicles that are not yet eligible for the remedy.

### 2. CONFIRM MODEL

- Confirm that this vehicle is a Sienna.

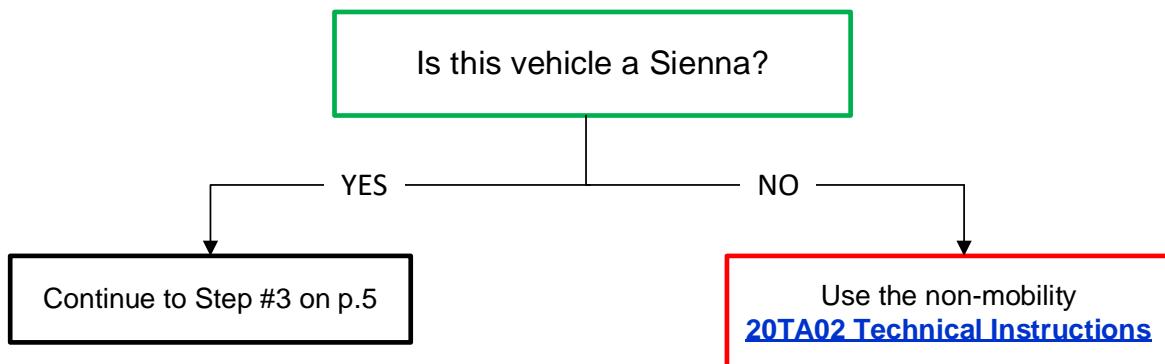

### 3. CHECK FOR FLOORBOARD & FUEL TANK MODIFICATIONS

- a. Inspect the vehicle to determine if modifications have been made to the floorboard of the vehicle to accommodate a ramp or lift for wheelchair use. Such modifications typically require the relocation and/or modification of the fuel tank. If the fuel tank has not been modified or relocated, use the non-mobility 20TA02 Technical Instructions.

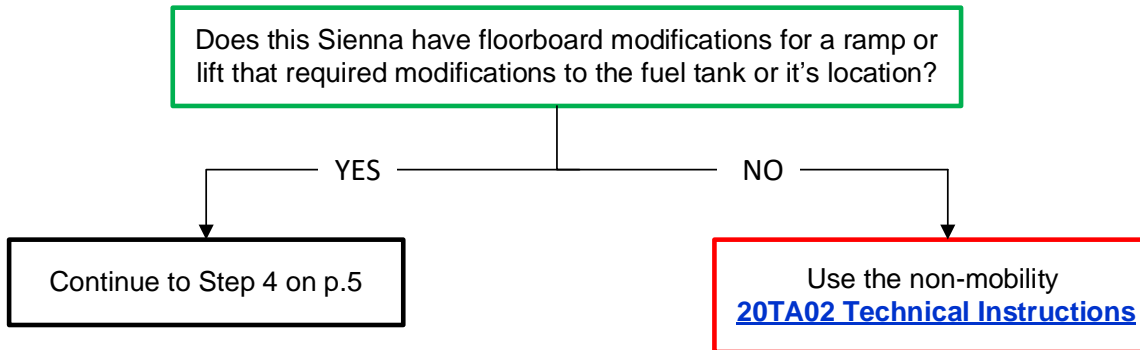

### 4. CHECK TIS MEMO FIELD FOR TOYOTA-APPROVED CONVERSION

- a. Check the Memo field in TIS to determine if the modifications on this vehicle were completed by a Toyota-authorized conversion company.

#### TIS Campaign Search:

**Campaign Description:** Safety Recall 20LA01 (Remedy Notice), Multiple Model and Model Years, Vehicle May Stall During Driving at Higher Speed  
**Campaign Status:** Remedy Available  
**Completion Status:** ~~Not Completed~~  
**Memo:** Toyota's records show that this unit has been converted for wheelchair accessibility by a Toyota-authorized company. Refer to Dealer Letter for additional details.

[Show Documents]

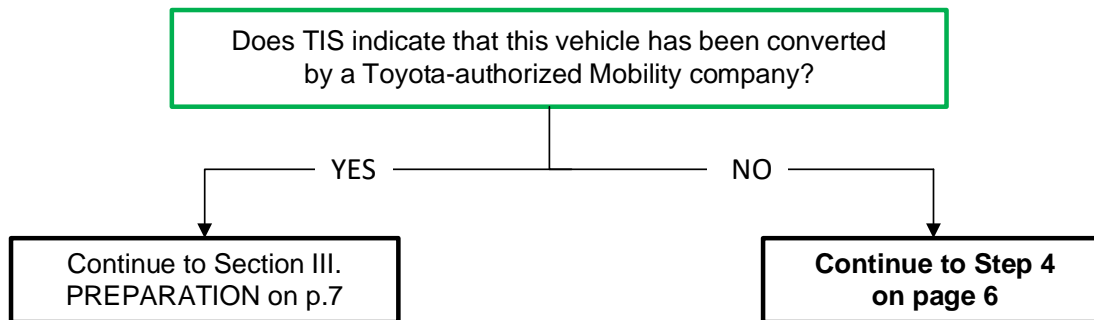

Note: In rare cases, Sienna vehicles converted by an authorized company may not appear in Toyota's records and; therefore, may not appear on TIS / Service lane as shown above. These vehicles should still have this remedy performed per the Technical Instructions.

#### Authorized Conversion Companies:

- The Braun Corporation (BraunAbility)
- Vantage Mobility International (VMI)

To determine the brand of conversion on mobility vans, the conversion companies usually apply their logos to the sides and rear hatch. It's also common to find stickers applied inside the driver's door jamb. If there are no visual indicators on the vehicle to identify the conversion company, ask the vehicle owner if they have the information available.

## 5. NON-APPROVED CONVERSION

Sienna vehicles that have been converted for wheelchair accessibility by a non-Toyota authorized mobility conversion company have undergone an unauthorized modification to the factory condition of the vehicle. These vehicles may be incompatible with the remedy in their current modified condition. Toyota does not recommend modifying vehicles and cannot evaluate how any aftermarket, non-Toyota approved parts and/or modifications could affect a vehicle's performance.

Subject to individual review by the dealer and notwithstanding Toyota's recommendation, some dealers may be willing to perform the Safety Recall remedy with the vehicle in its current modified condition. If your dealership is willing to do so, the customer may be responsible for the cost of parts and/or labor not otherwise covered by Toyota's Safety Recall. Toyota provides the specific remedy parts, differential oil (AWD-only), and covers 2.6 – 2.7 hours of dealership labor expenses. The customer is responsible to pay any additional charges for parts and/or labor which are the result of the vehicle's non-Toyota-approved modifications.

Toyota is not responsible for later performance problems the vehicle may have that are the result of the non-Toyota-approved vehicle modifications.

Because the modifications to this vehicle are unknown to Toyota, there will be no repair instructions available. If the dealer decides to proceed with the repair, it will up to the technician to determine the best method to remove the fuel tank and replace the fuel pump. Torque values for reinstallation will need to be determined by contacting the conversion company.

If the dealer decides it cannot complete the repair on a non-authorized conversion due the modifications in that case, the dealer may advise the customer that they have the option of contacting the conversion company for direction. Although the conversion company may or may not be able to provide a solution for the customer, the conversion company may, in the alternative, remove the fuel tank and fuel suction tube assembly, at the customer or conversion company's expense. In this case, the Toyota dealer could then be able to install the remedy low-pressure fuel pump into the fuel suction tube assembly free-of-charge. The re-installation of the fuel suction tube assembly and fuel tank into the vehicle would need to be performed at the customer or conversion company's expense by the conversion company in this case.

If upon inspection it's determined that this vehicle does not use a Toyota fuel pump, as originally designed, email the Quality Compliance Dept ([quality\\_compliance@toyota.com](mailto:quality_compliance@toyota.com)) for further instructions.

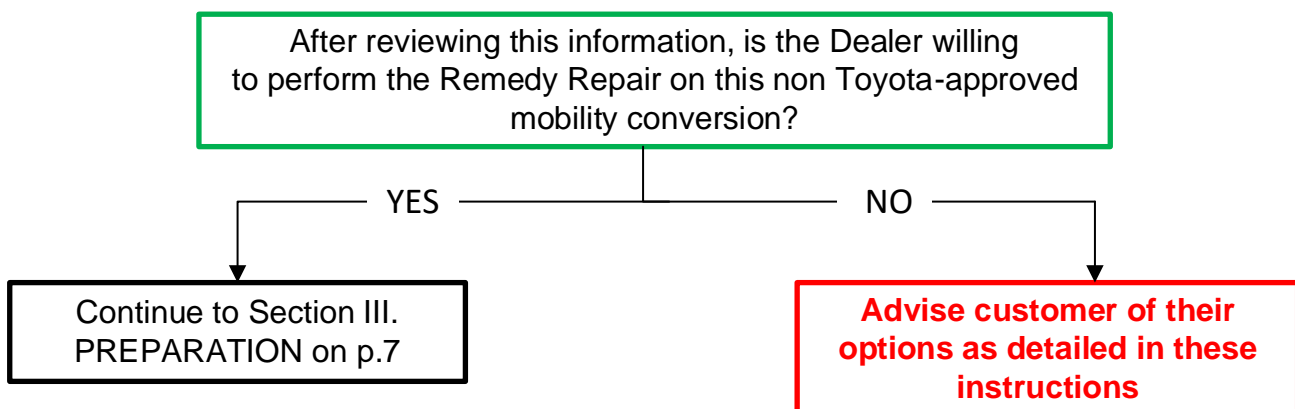

### III. PREPARATION

#### A. PARTS

Because of the extensive list of parts for this model, a website has been created to detail the required parts. Reference the following website for a detailed parts list for **each specific VIN**:

<https://20ta02.imagespm.info>

To log into the website:

- a. Enter your dealer code in the Dealer Code field.
- b. Enter XXXXX (5 Capital X's) for the Password.

**Note: Warranty will only reimburse dealers for the part numbers listed on the website. Any other part numbers will not be accepted on the campaign claim.**

#### B. TOOLS & EQUIPMENT





- Standard Hand Tools
- Torque Wrench
- Air Blow gun
- Gas Caddy (minimum 25 gallon capacity)

#### C. MATERIALS

- Brake Cleaner

C. Special Service Tools

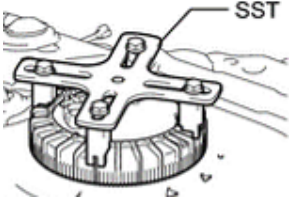
Sienna vehicles that have been modified by Toyota-authorized conversion companies could have the following Retainer Ring types. Vehicles that have been modified by non-authorized companies may have different types of Fuel Pump Housing Retainers.

RETAINER TYPE	
Type:	<div style="display: flex; justify-content: space-around;"> <div style="text-align: center;"> <p>Bolt In</p>  </div> <div style="text-align: center;"> <p>Plastic Ring</p>  </div> </div>
SST:	<div style="display: flex; justify-content: space-around;"> <div style="text-align: center;"> <p>No SST Required</p> </div> <div style="text-align: center;">  <p>Fuel Sender Lock Nut Wrench Kit <a href="#">(09808-14031)</a></p> <p>Option 1: Claw: 50mm Jaw Set <a href="#">(09808-01040)</a></p> <p>Option 2: Claw: Sliding jaw <a href="#">(09808-01080)</a></p> <p>Crossbar <a href="#">(09808-01030)</a></p> </div> </div>
Special Notes:	<p><b><u>Aftermarket alternative:</u></b></p> <p>CTA Tools 1044 Fuel Tank Lid Wrench</p>  <p>This tool is available from <a href="http://Autopart.com">Autopart.com</a></p> <p>Or contact <a href="http://CTA Tools">CTA Tools</a> at <a href="mailto:info@ctatools.com">info@ctatools.com</a> for purchasing inquiries</p>
Brands	<div style="display: flex; justify-content: space-between;"> <div style="width: 45%;">Braun Rear Entry</div> <div style="width: 45%;">Braun Side Entry VMI</div> </div>



## IV. BACKGROUND

The subject vehicles are equipped with a low-pressure fuel pump which may stop operating. If this were to occur, warning lights and messages may be displayed on the instrument panel, and the engine may run rough. This may result in a vehicle stall, and the vehicle may be unable to be restarted. If a vehicle stall occurs while driving at higher speeds, this could increase the risk of a crash.

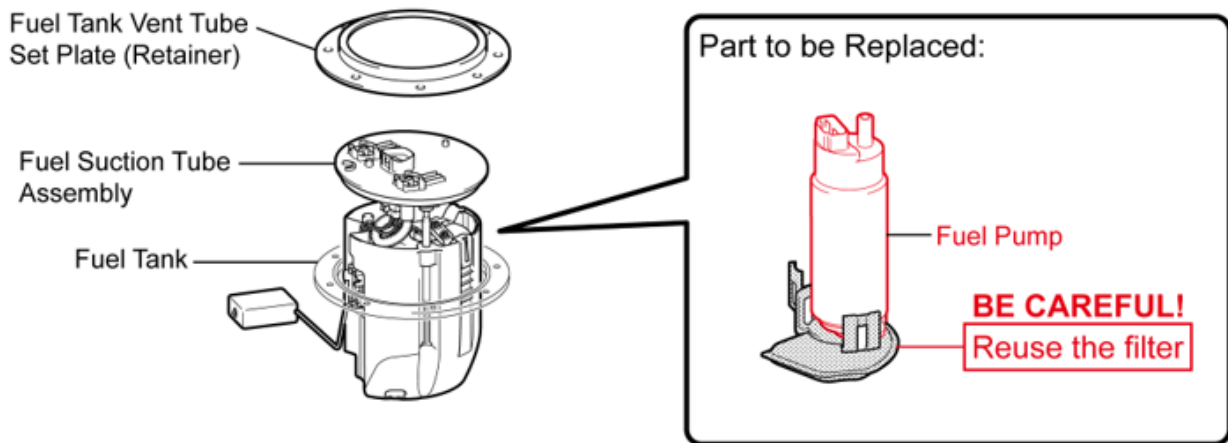

\*The configuration of the parts will differ depending on the specification.

S38182aSU

## V. SAFETY PRECAUTIONS

### CAUTION:

- When installing/uninstalling the fuel system components, keep safety first in mind and carefully observe the following instructions to avoid accidents:
  - a. When working on the fuel system, display a Flammable - Keep Fire Away sign.
  - b. Smoking is prohibited nearby.
  - c. Perform this work in an area where there are no sparks nearby from the operation of welders, grinders, drills, electric motors, stoves, etc.
  - d. **DO NOT** use electrical devices nearby because they can become hot and the operation of power switches can generate sparks.
  - e. **DO NOT** use iron or steel hammers while working, because they may generate sparks.
  - f. **DO NOT** start engines even in adjacent stalls.
  - g. Prepare fire extinguishers before starting any work.
  - h. Perform this work in a well-ventilated area (natural ventilation). **DO NOT** use exhaust fans or electric fans, because their motors might generate sparks.
  - i. Since it is possible for fuel vapor to build up, **DO NOT** work in or near a pit.
  - j. If fuel is spilled, use shop towels or similar material to quickly wipe it up and then use compressed air to diffuse the fuel vapor.
  - k. Shop towels and other materials that have come into contact with fuel should be dried in a well-ventilated area and then disposed of as appropriate.

## VI. COMPONENTS

Example Only. Modifications performed on Mobility Vehicles may be different than indicated.

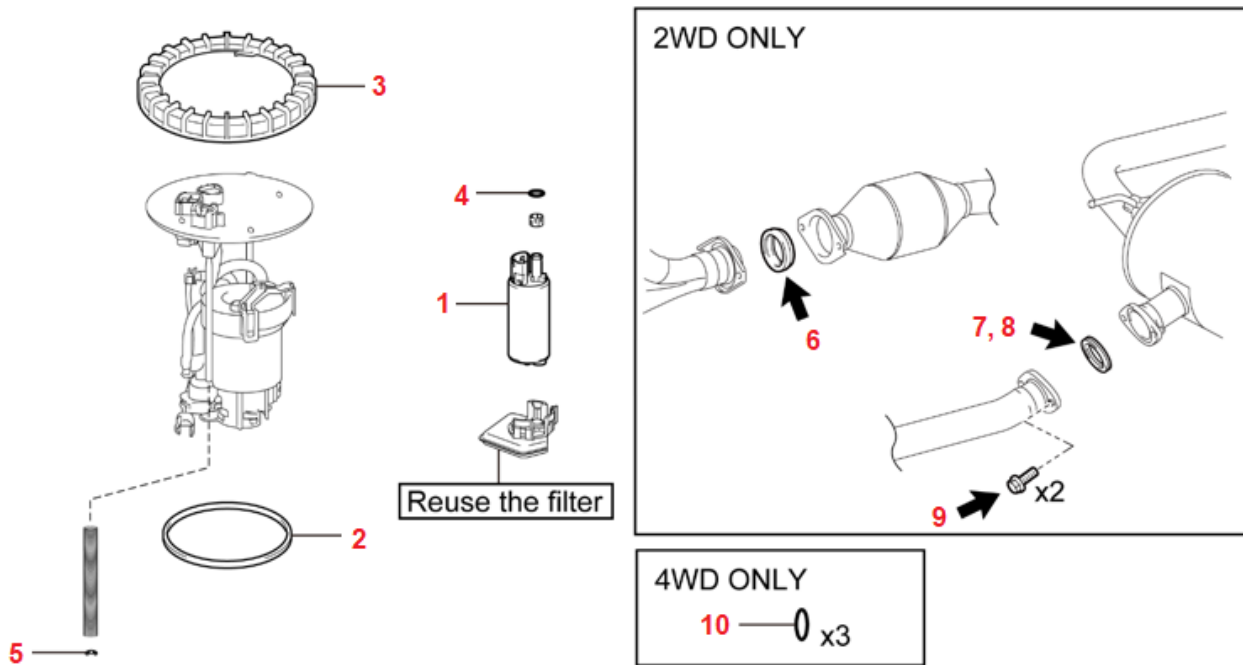

Replacement items in red

Note: Due to the variances in design of fuel tanks in mobility vehicles, this diagram should be only be used as a guide. The actual installation method of the Fuel Tube Assemblies may differ from original equipment.

No.	Contents of Part Kit's	Quantity	Remarks
1	FUEL PUMP	1	
2	FUEL SUCTION TUBE SET GASKET	1	
3	FUEL PUMP GAUGE RETAINER	1	
4	O-RING	1	
5	FUEL TANK PIPE SETTING HOLDER	1	
6	EXHASUT PIPE GASKET (2WD)	1	16.4mm
7	EXHASUT PIPE GASKET (2WD)	1	
8	EXHASUT PIPE GASKET (2WD)	1	
9	FLANGE BOLT (2WD)	2	
10	DRAIN PLUG GASKET (4WD)	3	

DO NOT order the individual parts listed here. It is provided as a reference to assist in the correct installation. Order the parts kit's specific to each VIN, as detailed in the parts lookup website (p. 4).  
 Warranty will only reimburse dealers for the part numbers listed on the website. Any other part numbers will not be accepted on the campaign claim.

## VII. REMOVE FUEL TUBE ASSEMBLY



### 1. CHECK FOR DTC'S

- Using a Techstream, perform a Health Check to check for Diagnostic Trouble Codes.

**Note:** This Safety Recall covers only the replacement of the fuel pump and associated parts. It does not cover the diagnosis or replacement of any other parts on the vehicle.

### REMOVAL TIP: FUEL LEVEL

If the fuel level inside the fuel tank is above the specified level, fuel may overflow from the fuel tank during the removal of the tank and fuel suction tube assembly. Confirm the fuel tank in Sienna Mobility Vehicles has been completely drained before proceeding.

FUEL LEVEL RECOMMENDATIONS	
Sienna Mobility Vehicle	<b>Drain Fuel Tank</b>

**Note:** Be sure to recover all fuel into an approved fuel recovery system. Suitable systems are available from the [Toyota Approved Dealer Equipment](#) website.

### REMOVAL TIP: PLASTIC RING RETAINERS

If removing the Plastic Ring type retainers, cut the 4 internal claws to prevent the Fuel Tube assembly from rotating during removal. This could cause damage to the fuel level sender, fuel tank, or fuel tube assembly.

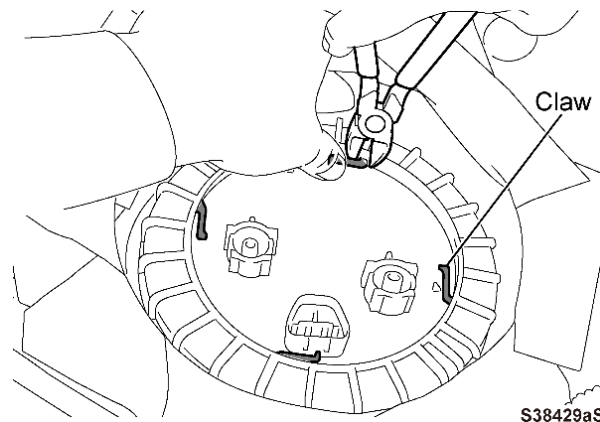

## REMOVAL TIP: TUBE ASSY ALIGNMENT

For vehicles with the plastic retainer rings, place matchmarks on both the Fuel Tube Assembly and the fuel tank. During disassembly, confirm that the Fuel Tube Assembly does not rotate. During reassembly, this will aid in aligning the locating tabs for proper installation.

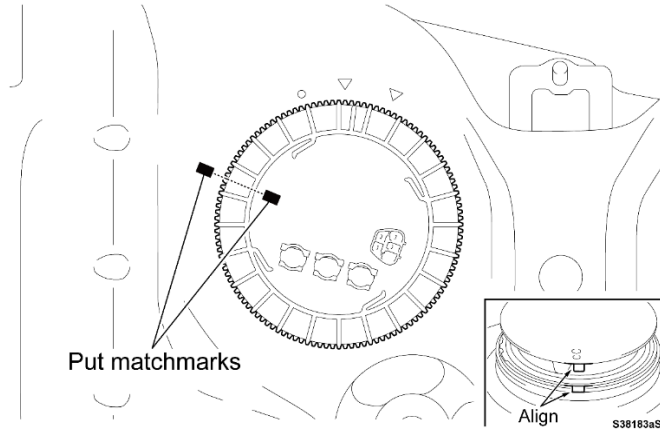

### 2. REMOVE FUEL TUBE ASSEMBLY FROM VEHICLE

Because of fuel tank modifications to mobility vehicles, the removal and installation procedure will be different than the Repair Manual instructions indicate. Reference the following links for details regarding the Toyota-authorized conversions:

Toyota-authorized Conversion Details:
<a href="#">BraunAbility</a>
<a href="#">Vantage Mobility International (VMI)</a>

#### Non-authorized Mobility Conversions:

Because the modifications to this vehicle are unknown to Toyota, there will be no repair instructions available. It will be up to the technician to determine the best method to remove the fuel tank and replace the fuel pump. Torque values for reinstallation will need to be determined by contacting the conversion company.

## VIII. DISASSEMBLE FUEL TUBE ASSEMBLY

### DISASSEMBLY TIP: FOLLOW THE REPAIR MANUAL

The Part's Kit contains the necessary O-Rings for reassembly, if the Repair Manual procedure is followed. If the pump components are disassembled in a manor other than as detailed in the Repair Manual, the Parts Kit may not contain the necessary O-Rings for proper reassembly. Please follow the procedures in the Repair Manual to ensure the correct O-Rings are available.

#### Example of Proper Disassembly:

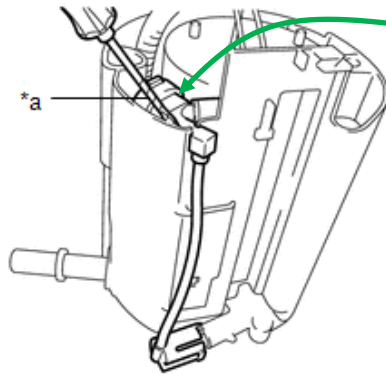

Repair Manual: Using a screwdriver (\*a) with its tip wrapped in protective tape, remove the jet pump from the No. 1 fuel sub-tank.

Tube still attached

Jet pump properly removed from the No.1 fuel sub-tank.

Replacement O-Ring will be installed in this location

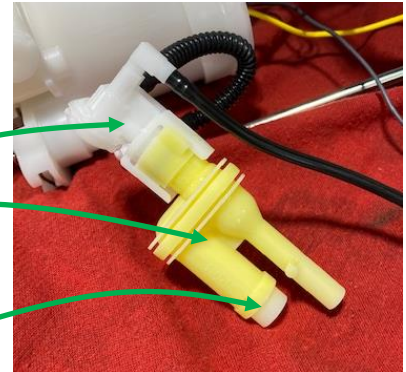

#### Example of Incorrect Disassembly:

Tube incorrectly removed from jet pump



Replacement O-ring is the incorrect size

DO NOT disconnect the tube from the jet pump

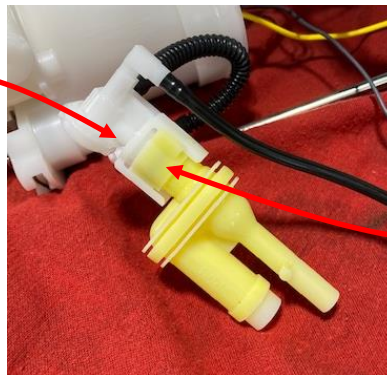

Replacement O-Ring is NOT provided for this location

## DISASSEMBLY TIP: MAIN VALVE AND REGULATOR

When replacing the fuel pump, it is not necessary to remove the Fuel Main Valve or Fuel Pressure Regulator. These O-Rings are NOT included in the parts kit.

DO NOT remove

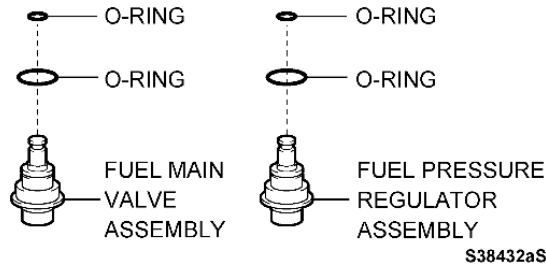

## DISASSEMBLY TIPS: FUEL FILTER

Be careful with the tabs when removing the filter from the original fuel pump as to not overextend them. When installing the filter on the **NEW** Fuel Pump, be sure that the clips have engaged properly.

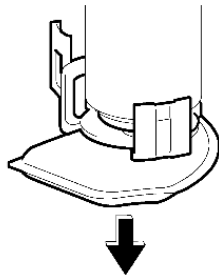

### 1. DISASSEMBLE FUEL SUCTION TUBE ASSEMBLY

- a. Follow the Repair Manual instructions to disassemble the Fuel Suction Tube Assembly.

## DISASSEMBLE FUEL TUBE

	<b>DISASSEMBLE FUEL TUBE</b>			
Sienna	<a href="#">2017</a>	<a href="#">2018</a>	<a href="#">2019</a>	<a href="#">2020</a>

### 2. CLEAN SUB TANK ASSEMBLY

- a. Using brake cleaner, clean the sub-tank assembly.

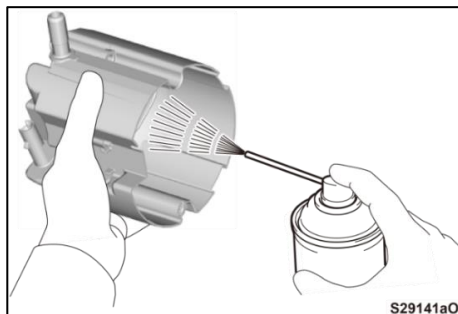

## IX. REASSEMBLE FUEL TUBE ASSEMBLY

### 1. CONFIRM PARTS

- a. Using the part lookup website, input the VIN number to confirm that you have the proper parts for this vehicle:

<https://20ta02.imagespm.info>

To log into the website:

- Enter your dealer code in the Dealer Code field.
- Enter XXXXX (5 Capital X's) for the Password.

### 2. REASSEMBLE FUEL SUCTION TUBE ASSEMBLY WITH **NEW** FUEL PUMP

- a. Follow the Repair Manual instructions to reassemble the Fuel Suction Tube Assembly with a **NEW** Fuel Pump.



**Refer to the Component diagrams at the beginning of these Technical Instructions to confirm the location of each replacement part.**

#### Example Procedure:

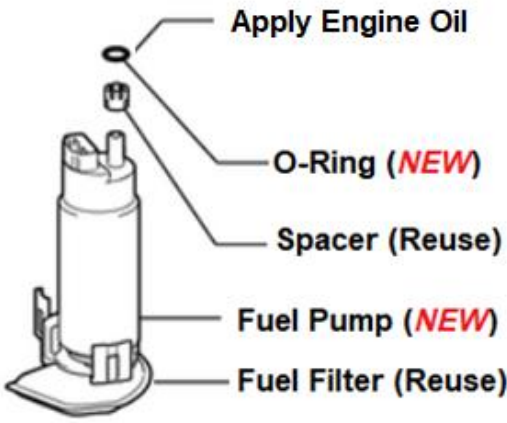
 <p><b>HINT:</b> The reused filter may be discolored.</p>	<ul style="list-style-type: none"><li>Remove the original O-Ring, Spacer and Fuel Filter from the original Fuel Pump.</li><li>Discard the original O-Ring and Fuel Pump, <u>saving the Spacer and Fuel Filter.</u></li><li>Install the original Spacer onto the <b>NEW</b> Fuel Pump.</li><li>Install the <b>NEW</b> O-Ring onto the <b>NEW</b> Fuel Pump. Refer to the Component Diagram to determine to proper O-Ring, as identified by the colored tape on the bag.</li><li>Apply a small amount of engine oil to the <b>NEW</b> O-Ring to assure correct installation into the Tube Assembly.</li><li>Install the original Fuel Filter onto the <b>NEW</b> Fuel Pump.</li><li>Refer to the <u>Components diagrams</u> to review the other <b>NEW</b> parts to install.</li></ul>
---	--

- Apply engine oil to the **NEW** O-ring before assembly to assure correct installation into the Fuel Suction Tube.

### 3. REASSEMBLE FUEL SUCTION TUBE ASSEMBLY

- b. Follow the Repair Manual instructions to reassemble the Fuel Suction Tube Assembly.

## REASSEMBLE FUEL TUBE

Sienna

[2017](#)

[2018](#)

[2019](#)

[2020](#)



## X. INSTALL FUEL TUBE ASSEMBLY

### INSTALLATION TIP: PLASTIC RETAINER (if used)

Set **NEW** gasket properly

**DO NOT** apply  
silicon grease

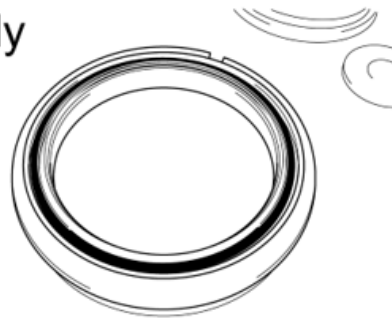

**OK**



**NG**



Put the retainer around the  
arm so that it is not necessary  
to change hands to keep  
pressing down the fuel  
suction tube.  
(Plastic Retainer)

Keep pressing down the fuel suction  
tube while installing the retainer.

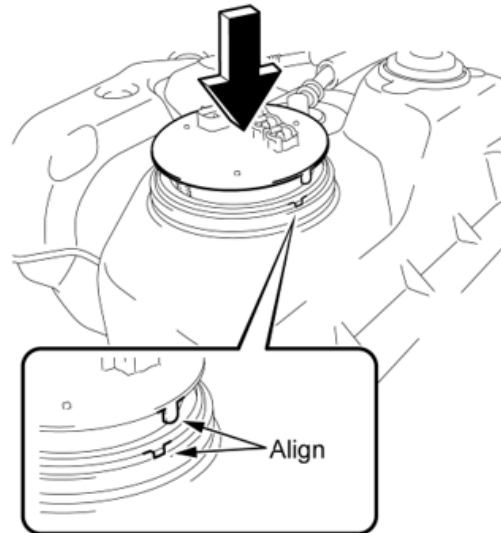
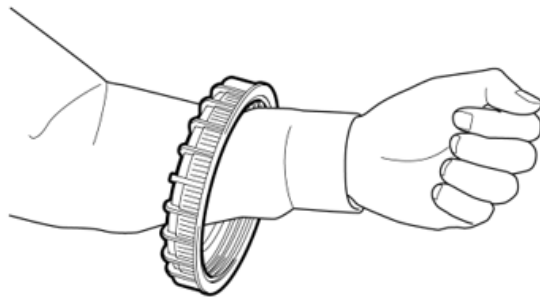

S38184aSU



## 1. INSTALL THE FUEL SUCTION TUBE AND TANK INTO VEHICLE

Because of fuel tank modifications to mobility vehicles, the removal and installation procedure will be different than the Repair Manual instructions indicate. If working on a Toyota-authorized conversion, use the disassembly instructions (p. 12) in reverse order.

If working on a non-authorized conversion, there will be no repair instructions available. Torque values for reinstallation will need to be determined by contacting the conversion company.



**Refer to the Component diagrams at the beginning of these Technical Instructions to confirm the location of each replacement part.**

## 2. INSTALL REMOVED FUEL

- a. Reinstall the originally recovered fuel into the tank.



## 3. CHECK FOR DTC'S

- a. Using a Techstream, perform a Health Check to check for Diagnostic Trouble Codes.

**Note:** *This Safety Recall covers only the replacement of the fuel pump and associated parts. It does not cover the diagnosis or replacement of any other parts on the vehicle.*

## ◀ VERIFY REPAIR QUALITY ▶

- Confirm no fuel leaks from vehicle
- Confirm any fuel drained from the vehicle has been reinstalled
- Test drive to confirm normal operation while under load
- Confirm no DTC's are present
- Confirm that all parts listed in the Components Diagrams have been properly installed on the vehicle.

## XI. APPENDIX

### A. PARTS DISPOSAL

In accordance with Federal law, please make sure all recalled parts (original parts) removed from the vehicle are disposed of in a manner in which they will not be reused, ***unless requested for parts recovery return.***

### B. CAMPAIGN DESIGNATION DECORDER

