



David J. Johnson
Director
Service Engineering Operations
Ford Customer Service Division

Ford Motor Company
P. O. Box 1904
Dearborn, Michigan 48121

September 11, 2020

TO: All U.S. Ford and Lincoln Dealers

**SUBJECT: NEW VEHICLE DEMONSTRATION / DELIVERY HOLD -
Safety Recall 20S36 – Supplement #1**

Certain 2021 Model Year Medium Duty Trucks equipped with 7.3L Engine
Cabin Floor and Seat Mount Thermal Management Repairs

New! REASON FOR THIS SUPPLEMENT

- *Parts are now available for open order*

AFFECTED VEHICLES

Vehicle	Model Year	Assembly Plant	Build Dates
Medium Duty	2021	Ohio	March 13, 2019 through June 8, 2020

Affected vehicles are identified in OASIS and FSA VIN Lists.

REASON FOR THIS SAFETY RECALL

The affected vehicles may have a missing under body heat shield, thermal insulator patch under the floor mat, or covers for the seat bolts and the seat pedestal. This may cause elevated temperatures on the interior cabin floor or seat attachments during certain high load and high ambient temperature driving conditions. Contact with exposed skin at these locations could cause skin irritation and/or a minor burn.

SERVICE ACTION

Dealers are to follow technical instructions on repairs required. This service must be performed on all affected vehicles at no charge to the vehicle owner.

New! OWNER NOTIFICATION MAILING SCHEDULE

Owner letters will begin mailing the week of September 28, 2020 advising customers parts are available. Dealers should repair any affected vehicles that arrive at their dealerships, whether or not the customer has received a letter.

PLEASE NOTE:

Federal law requires dealers to complete this recall service before a new vehicle is delivered to the buyer or lessee. Violation of this requirement by a dealer could result in a civil penalty of up to \$21,000 per vehicle. Correct all vehicles in your new vehicle inventory before delivery.

ATTACHMENTS

Attachment I: Administrative Information
Attachment II: **Labor Allowances and Parts Ordering Information**
Attachment III: Technical Information
Owner Notification Letters

QUESTIONS & ASSISTANCE

For questions and assistance, contact the Special Service Support Center (SSSC) via the SSSC Web Contact Site. The SSSC Web Contact Site can be accessed through the Professional Technician Society (PTS) website using the SSSC link listed at the bottom of the OASIS VIN report screen or listed under the SSSC tab.

Sincerely,

A handwritten signature in black ink, appearing to read "D. Johnson".

David J. Johnson

**NEW VEHICLE DEMONSTRATION / DELIVERY HOLD -
Safety Recall 20S36 – Supplement #1**
Certain 2021 Model Year Medium Duty Trucks equipped with 7.3L Engine
Cabin Floor and Seat Mount Thermal Management Repairs

OASIS ACTIVATION

OASIS was activated on July 20, 2020

FSA VIN LISTS ACTIVATION

FSA VIN Lists was made through <https://web.fsavinlists.dealerconnection.com> on July 20, 2020. Owner names and addresses will be available once parts are available to repair all vehicles.

NOTE: Your FSA VIN Lists may contain owner names and addresses obtained from motor vehicle registration records. The use of such motor vehicle registration data for any purpose other than in connection with this recall is a violation of law in several states, provinces, and countries. Accordingly, you must limit the use of this listing to the follow-up necessary to complete this recall.

SOLD VEHICLES

- Ford has not issued instructions to stop selling/delivering or driving used vehicles under this safety recall. Owners should contact their dealer for an appointment to have their vehicles remedied as soon as practicable. Owners can continue to safely drive their vehicles.
- Immediately contact any of your affected customers whose vehicles are not on your VIN list but are identified in OASIS. Give the customer a copy of the Owner Notification Letter (when available) and schedule a service date.
- Correct other affected vehicles identified in OASIS which are brought to your dealership.
- Dealers are to prioritize repairs of customer vehicles over repairs of new and used vehicle inventory.

STOCK VEHICLES

- Correct all affected units in your new vehicle inventory before delivery.
- Use OASIS to identify any affected vehicles in your used vehicle inventory.

DEALER-OPERATED RENTAL VEHICLES

The Fixing America's Surface Transportation (FAST) Act law effective June 2016 prohibits a rental company from selling, renting or leasing vehicles subject to a safety or compliance recall. Please consult your legal counsel for legal advice.

TITLE BRANDED / SALVAGED VEHICLES

Affected title branded and salvaged vehicles are eligible for this recall.

OWNER REFUNDS

Refunds are not approved for this program.

RENTAL VEHICLES

Rental vehicles are not approved for this program.

**NEW VEHICLE DEMONSTRATION / DELIVERY HOLD -
Safety Recall 20S36 – Supplement #1**

Certain 2021 Model Year Medium Duty Trucks equipped with 7.3L Engine
Cabin Floor and Seat Mount Thermal Management Repairs

ADDITIONAL REPAIR (LABOR TIME AND/OR PARTS)

Additional repairs identified as necessary to complete the FSA should be managed as follows:

- For related damage and access time requirements, refer to the Warranty and Policy Manual / Section 6 – Ford & Lincoln Program Policies / General Information & Special Circumstances for FSA's / Related Damage.
- For vehicles within new vehicle bumper-to-bumper warranty coverage, no SSSC approval is required, although related damage must be on a separate repair line with the "Related Damage" radio button checked.
 - F-650/F-750 trucks – 2 years, regardless of miles driven

CLAIMS PREPARATION AND SUBMISSION

- **Claim Entry:** Enter claims using Dealer Management System (DMS) or One Warranty Solution (OWS) online.
 - When entering claims, select claim type 31: Field Service Action. The FSA number 20S36 is the sub code.
 - For additional claims preparation and submission information, refer to the Recall and Customer Satisfaction Program (CSP) Repairs in the OWS User Guide.
- **Related Damage/Additional labor and/or parts:** Must be claimed as Related Damage on a separate repair line from the FSA with same claim type and sub code as described in Claim Entry above.

IMPORTANT: Click the Related Damage Indicator radio button.

- **Provision for Foil Tape:**
 - JL3Z-19E523-A Foil Tape or equivalent
 - Program Code: 20S36
 - Misc. Expense: OTHER
 - Amount: Up to \$2.00 per vehicle

**NEW VEHICLE DEMONSTRATION / DELIVERY HOLD -
Safety Recall 20S36 – Supplement #1**
Certain 2021 Model Year Medium Duty Trucks equipped with 7.3L Engine
Cabin Floor and Seat Mount Thermal Management Repairs

LABOR ALLOWANCES

Description	Labor Operation	Labor Time
<ul style="list-style-type: none"> Install heat patch under floor covering Inspect seat bolt/pedestal protective covers and underbody heat shield 	20S36B	0.5 Hours
<ul style="list-style-type: none"> Install heat patch under floor covering Install seat bolt/pedestal protective covers Inspect for underbody heat shield 	20S36C	0.7 Hours
<ul style="list-style-type: none"> Install heat patch under floor covering Inspect for seat bolt/pedestal protective covers Install underbody heat shield 	20S36D	1.0 Hours
<ul style="list-style-type: none"> Install heat patch under floor covering Install seat bolt/pedestal protective covers Install underbody heat shield 	20S36E	1.2 Hours

New! PARTS REQUIREMENTS / ORDERING INFORMATION

NOTE: All parts are on open order

Part Number	Description	Order Quantity	Claim Quantity
4C2Z-1511173-A	Floor Heat Patch	1	1
DC3Z-2511172-A	Underbody Heat Shield (Order only if required)	1	1
W705002-S300	Push Clip (For installing underbody heat shield only, 3 req 1 in pkg)	3	3
W715272-S300	Push Clip (For installing underbody heat shield only, 3 required, 4 in pkg)	1	3
JL3Z-19E523-A	Foil Tape or equivalent (Used in FSA 19S52)	Misc.	Misc.
MC4Z-16611D02-A	Seat Bolt Cover (Front half bolts and seat belt bolts)	Order Per Technical Instruction	Up to 6
MC4Z-16611D02-B	Seat Bolt Cover (Rear half stud/nut)		4
MC4Z-16611D02-C	Seat Bolt Cover (Rear seat bolt covers)		3
MC4Z-99611D02-A	Non-Air Ride Seat Pedestal Cover		Up to 4
MC4Z-99611D02-B	Air Rise Seat Pedestal Cover		Up to 2

To guarantee the shortest delivery time, an emergency order for parts must be placed.

**NEW VEHICLE DEMONSTRATION / DELIVERY HOLD -
Safety Recall 20S36 – *Supplement #1***

Certain 2021 Model Year Medium Duty Trucks equipped with 7.3L Engine
Cabin Floor and Seat Mount Thermal Management Repairs

DEALER PRICE

For latest prices, refer to DOES II.

PARTS RETENTION AND RETURN

Follow the provisions of the Warranty and Policy Manual, Section 1 - WARRANTY PARTS
RETENTION AND RETURN POLICIES.

EXCESS STOCK RETURN

Excess stock returned for credit must have been purchased from Ford Customer Service Division in
accordance with Policy Procedure Bulletin 4000.

CERTAIN 2021 MODEL YEAR MEDIUM DUTY TRUCKS EQUIPPED WITH 7.3L ENGINE — CABIN FLOOR AND SEAT MOUNT THERMAL MANAGEMENT REPAIRS

Table of Contents

- Service Procedures

- a. Cabin Floor Thermal Patch Installation Procedure..... Pages 1-3
- b. Seat Mount Thermal Covers Inspection Procedures.....Pages 4-6
- c. Seat Mount Thermal Covers Installation Procedures.....Pages 7-13
- d. Underbody Heat Shield Inspection Procedure.....Pages 14-15
- e. Underbody Heat Shield Installation Procedure.....Pages 15-21

NEW ! SERVICE PROCEDURE

CABIN FLOOR THERMAL PATCH INSTALLATION PROCEDURE

1. Release the clips and remove the front Left Hand (LH) side scuffplate trim panel. See Figure 1.

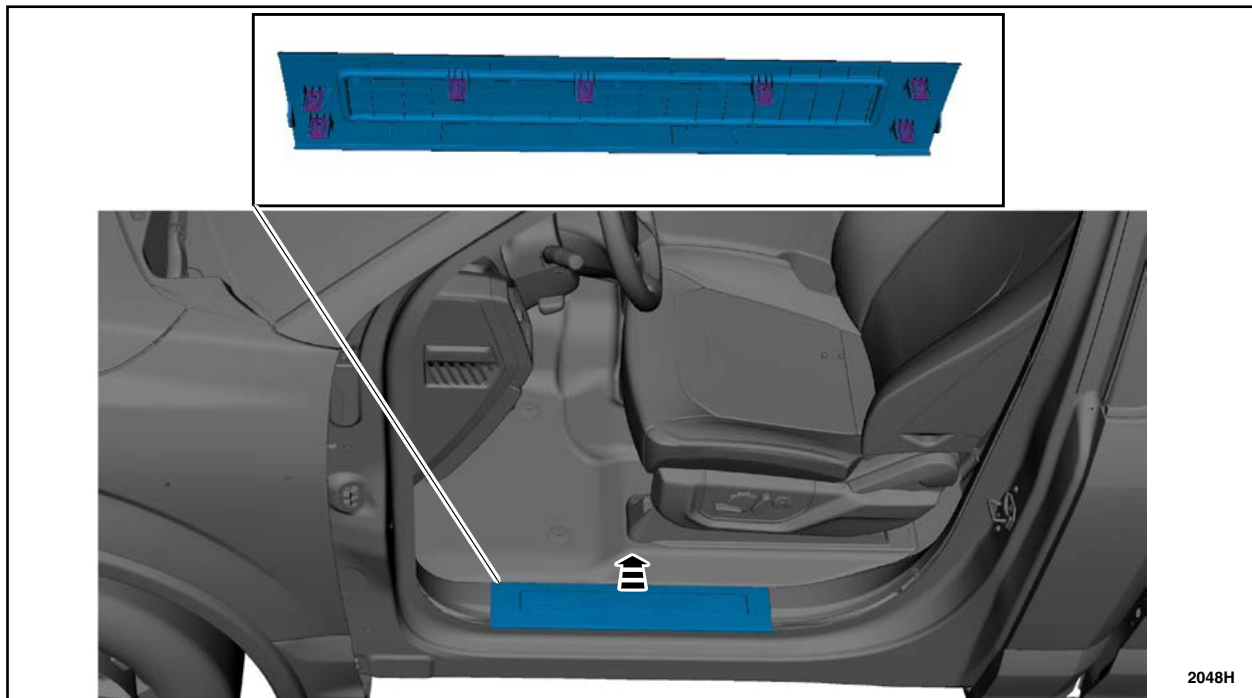

FIGURE 1



2. Remove the front LH cowl side trim panel. See Figure 2.

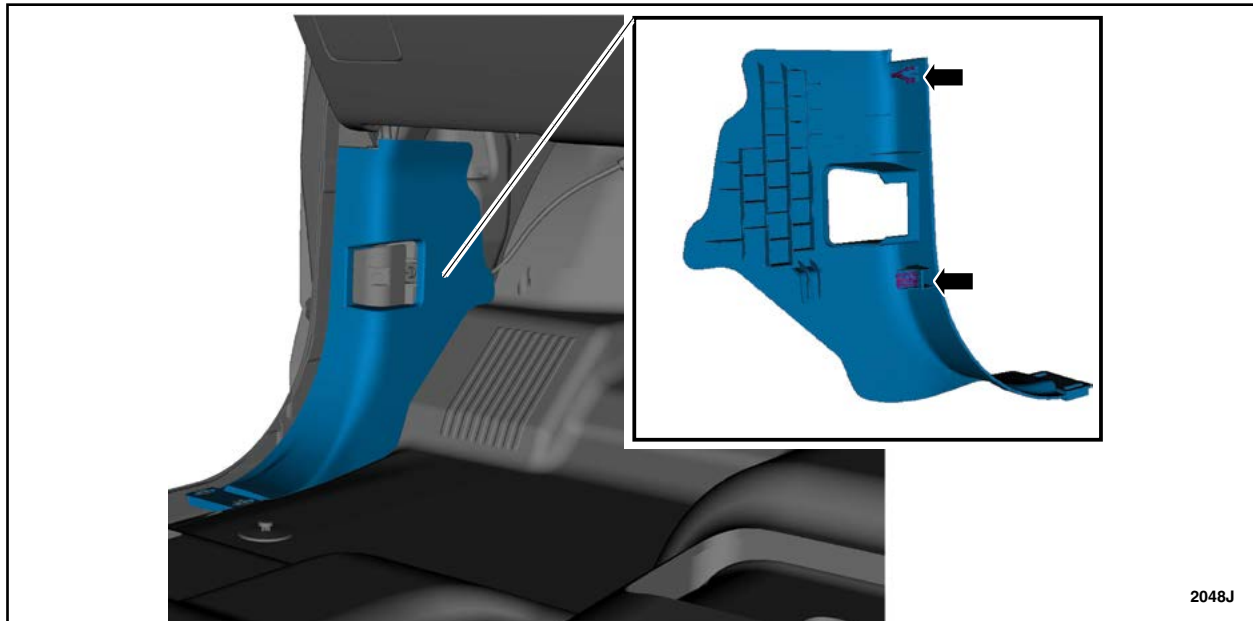

FIGURE 2

3. Lift up the carpet until the highlighted area, just below the brake pedal, is visible. See Figure 3.



FIGURE 3



4. Peel the protective backing cover from the *new* cabin floor thermal patch and install it over the highlighted area in Figure 3. Start at the bottom, sticky side down, and align the lower outboard heel of the thermal patch so that it sets between the areas indicated in Figure 4.

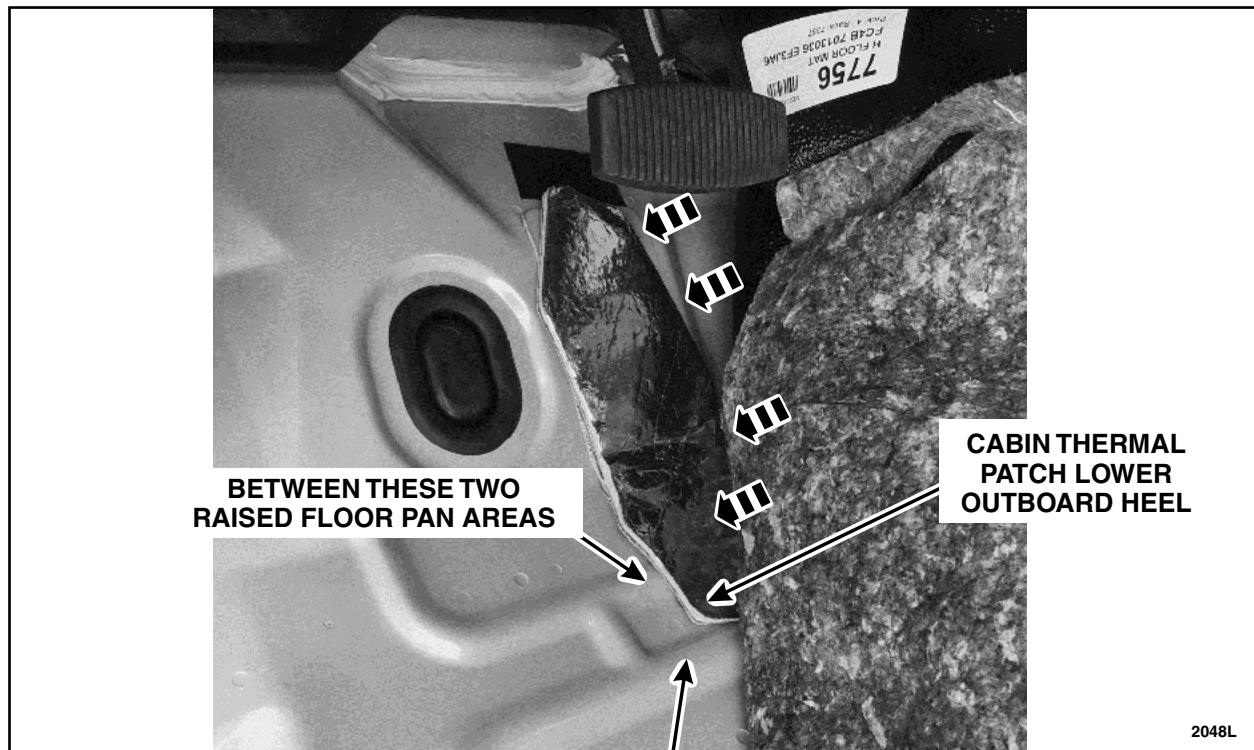

FIGURE 4

5. Position the carpet down and install the front LH cowl side trim panel. See Figure 2.
6. Install the front LH side scuffplate trim panel. See Figure 1.
7. Proceed to the 'Seat Mount Thermal Covers Inspection Procedure' on Page 4.



SEAT MOUNT THERMAL COVERS INSPECTION PROCEDURE

1. Inspect for the presence of the following thermal covers for the vehicle type being inspected:

Regular Cabs - a. Covers and sleeve on both front seat, front bolts (4). See Figure 5.

Non-Air Ride Seat

Super Cabs and Crew Cabs - a. Covers and sleeve on both front seat, front bolts (4). See Figure 5.
b. Covers on both front seatbelt buckle anchor bolts (2). See Figure 6.
c. Covers on all bolts, on the front seat, rear bolts (4). See Figure 7.
d. Covers on the rear seat, front bolts (3). See Figure 8.

Air Ride Equipped Seat

Super Cabs and Crew Cabs - a. Covers and sleeve on front seat, front bolts (4). See Figure 9
b. Covers on both front seatbelt buckle anchor bolts (2). See Figure 6.
c. Covers on all bolts, on the front seat, rear bolts (4). See Figure 7.
d. Covers on the rear seat, front bolts (3). See Figure 8.

- Are all covers present for the vehicle type inspected?

Yes - Proceed to 'Underbody Heat Shield Inspection' on Page 14.

No - Proceed to the 'Seat Mount Thermal Covers Installation Procedures' on Page 7.

There are multiple repair procedures for the seat mount thermal covers, perform the necessary procedure(s) to complete the seat mount thermal cover installations per the vehicle cab type and the needed seat mount thermal covers that were identified during the inspection.

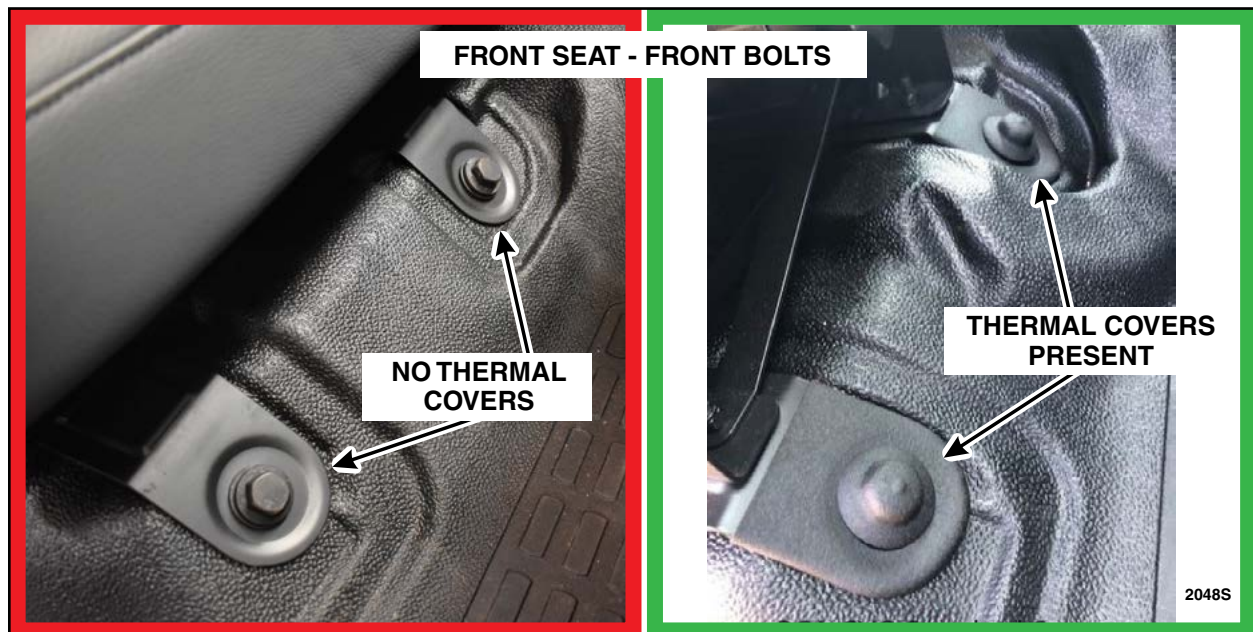

FIGURE 5



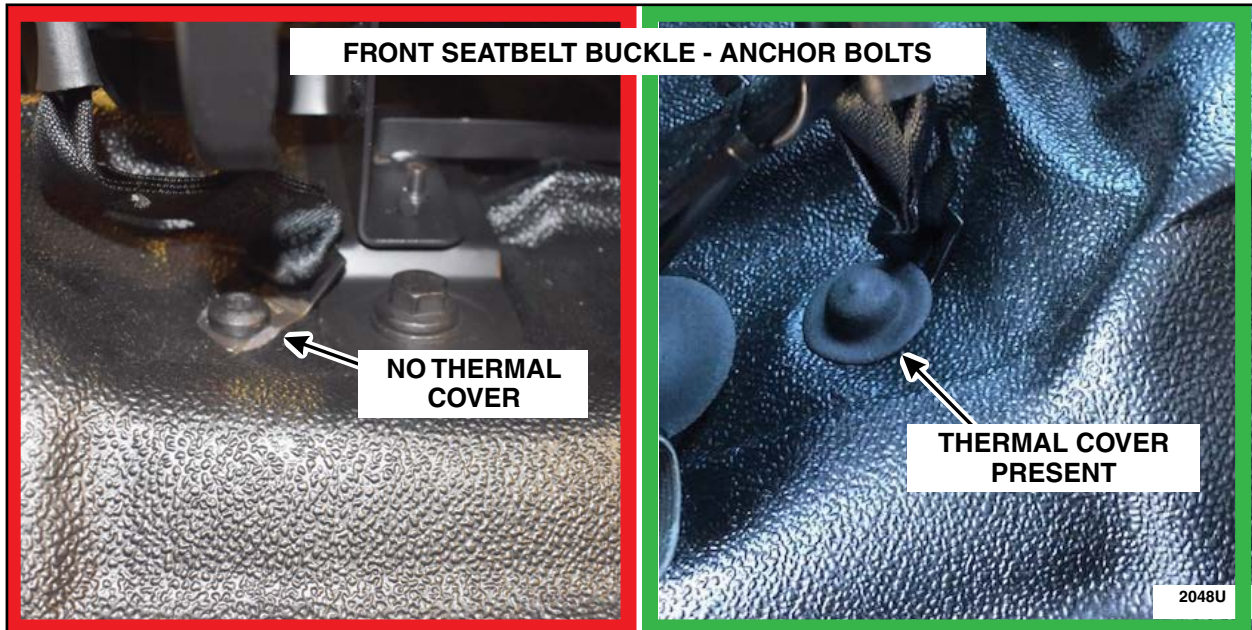

FIGURE 6

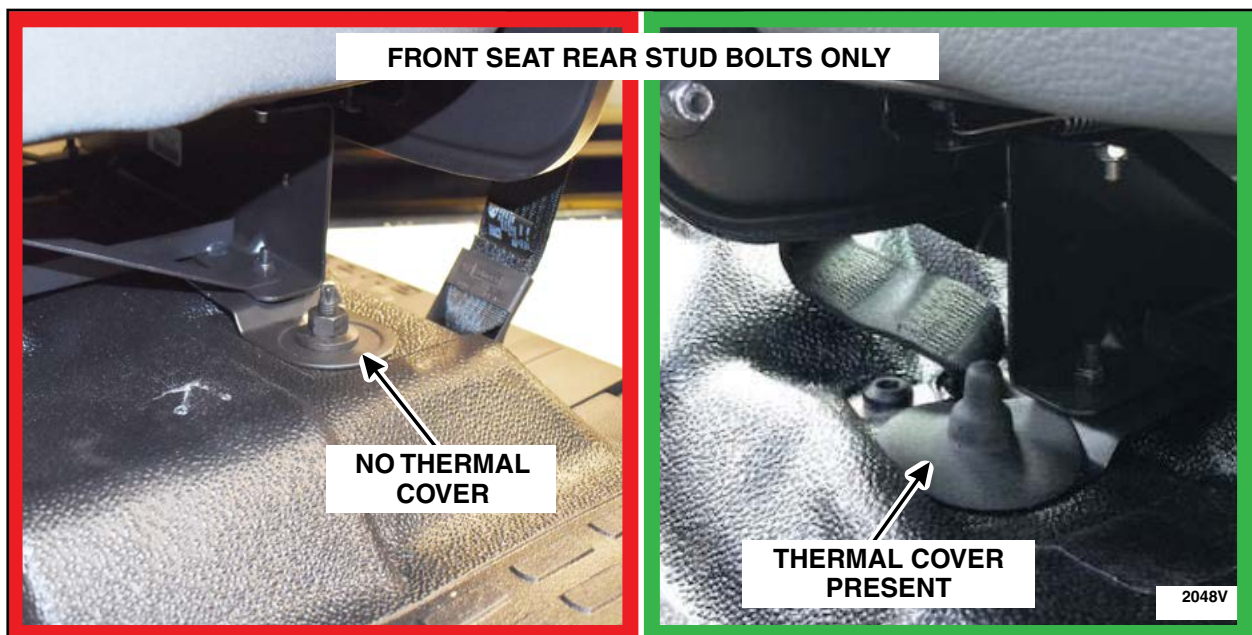

FIGURE 7



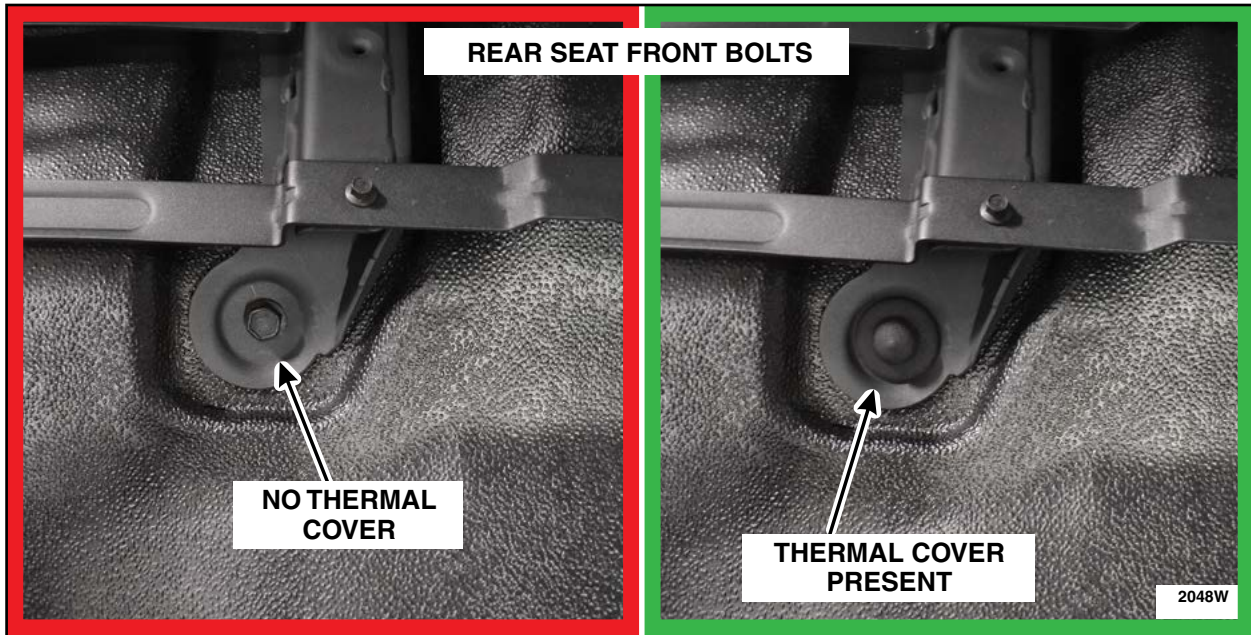

FIGURE 8

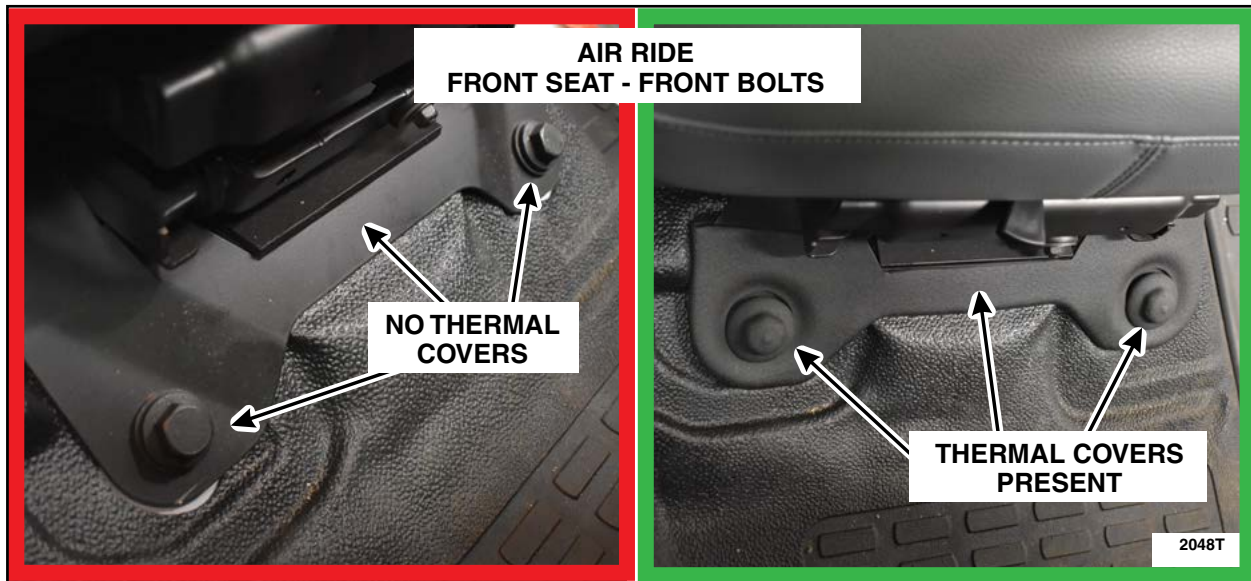

FIGURE 9



SEAT MOUNT THERMAL COVERS INSTALLATION PROCEDURES

ALL FRONTS SEATS EXCEPT AN AIR RIDE EQUIPPED SEAT (Proceed to Page 9)

1. Remove both of the front bolts from the front seat.
2. Install a thermal protective sleeve over both front seat track legs as shown in Figure 10.

NEW ! NOTE: Use Part Number MC4Z-99611D02-A, 2 required per seat.

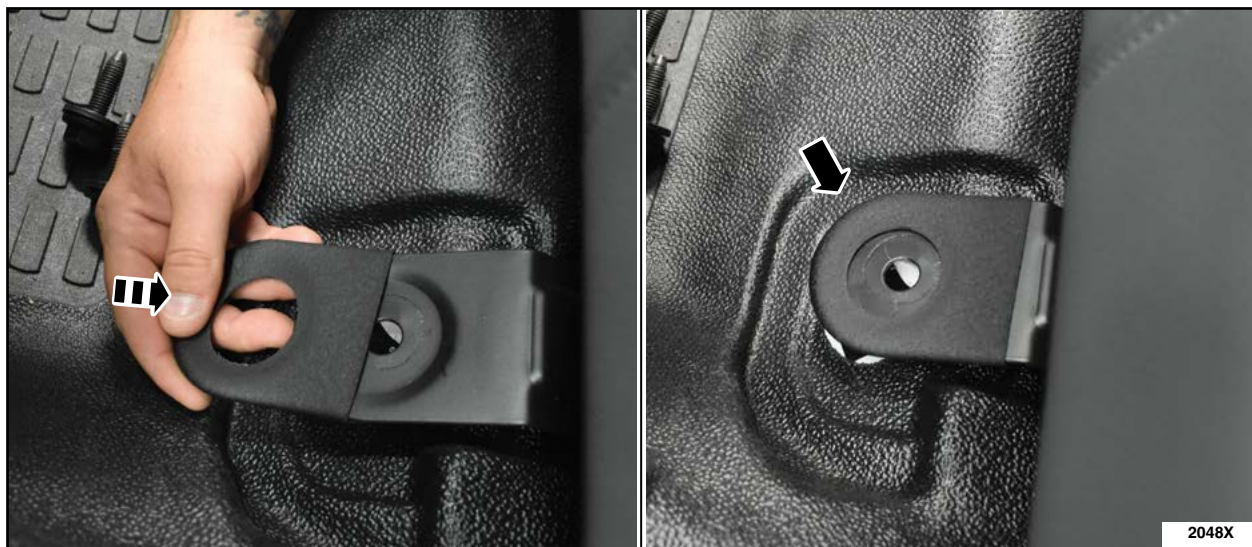

FIGURE 10



3. Position the seat track back into position and install the bolt.

- Torque: 52 lb.ft (70 Nm).

4. Install a seat bolt thermal protective cover as shown in Figure 11.

NOTE: Use Part Number MC3Z-16611D02-A, 2 required per seat.

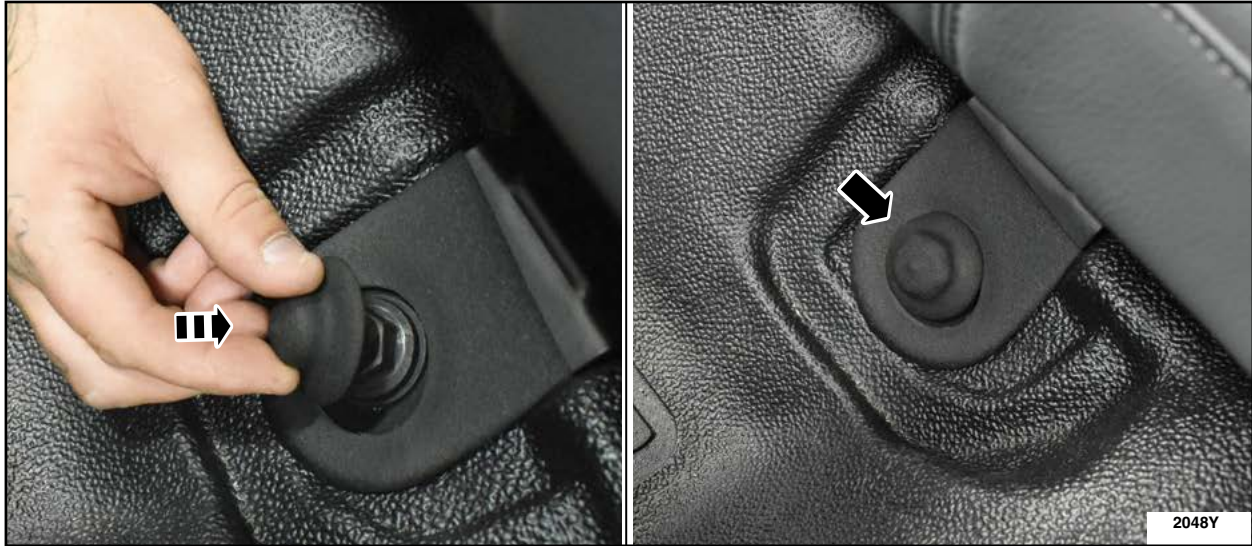

FIGURE 11

5. Repeat Steps 1 through 4 to the remaining seat.

- Regular Cab vehicles proceed to the 'Underbody Heat Shield Inspection'.
- Super Cab and Crew Cab vehicles continue on with the 'Seat Mount Thermal Covers Installation Procedures' until all of the inspected bolts that needed thermal covers have been installed.



FRONT AIR RIDE EQUIPPED SEAT ONLY

1. Remove the two (2) front bolts from the drivers front seat.
2. Install the thermal protective sleeve over the front seat track leg as shown in Figure 12.

NOTE: Use Part Number MC4Z-99611D02-B, 1 per seat.



FIGURE 12



3. Position the seat track leg back into position and install the bolts.

- Torque: 52 lb.ft (70 Nm).

4. Install a seat bolt thermal protective covers as shown in Figure 13.

NOTE: Use Part Number MC4Z-16611D02-A, 2 per seat.



FIGURE 13

5. If equipped with an air ride passenger seat, repeat Steps 1 through 4.

- Regular Cab vehicles proceed to the 'Underbody Heat Shield Inspection'.
- Super Cab and Crew Cab vehicles continue on with the 'Seat Mount Thermal Covers Installation Procedures' until all of the inspected bolts that needed thermal covers have been installed.



FRONT SEAT - REAR BOLTS

SUPERCAB AND CREWCAB VEHICLES ONLY

1. Install 2 front seat, rear bolt thermal covers per seat as shown in Figure 14.

NOTE: Use Part Number MC4Z-16611D02-B, 2 per seat.



FIGURE 14

2. Repeat Step 1 to the remaining front seat rear bolts.

- Super Cab and Crew Cab vehicles continue on with the 'Seat Mount Thermal Covers Installation Procedures' until all of the inspected bolts that needed thermal covers have been installed.



REAR SEAT - FRONT BOLTS

1. Install the rear seat front bolt covers as shown in Figure 15.

NOTE: Use Part Number MC4Z-16611D02-C, 3 required.

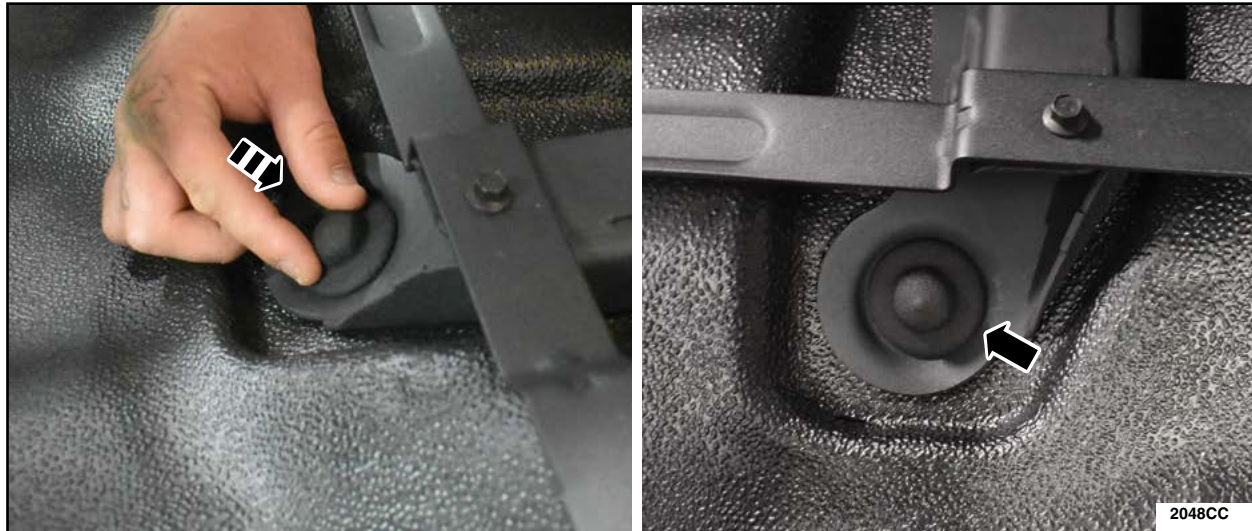

FIGURE 15

2. Repeat Step 1 to the remaining 2 bolts.

- Super Cab and Crew Cab vehicles continue on with the 'Seat Mount Thermal Covers Installation Procedures' until all of the inspected bolts that needed thermal covers have been installed.



BOTH FRONT SEATBELT BUCKLE ANCHOR BOLTS

SUPERCAB AND CREWCAB VEHICLES ONLY

1. Install a thermal protective cover over both front seatbelt buckle anchor bolts as shown in Figure 16.

NOTE: Use Part Number MC4Z-16611D02-A, 1 per seatbelt anchor bolt.

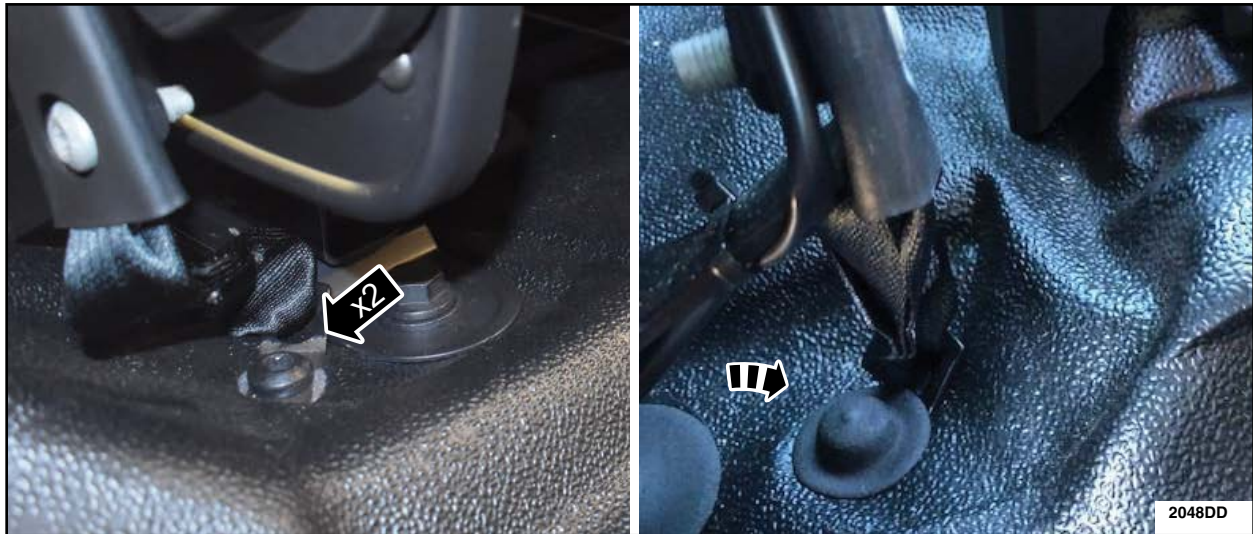

FIGURE 16

2. Seat mount thermal covers installation complete, all Super Cab and Crew Cab vehicles proceed to the 'Underbody Heat Shield Inspection' on Page 14.



UNDERBODY HEAT SHIELD INSPECTION PROCEDURE

1. Inspect for the presence of an underbody tunnel heat shield over the transmission assembly. Is there a tunnel heat shield present? See Figures 17 and 18.

Yes - PASS - Repair complete.

No - DOES NOT PASS - Proceed to the Service Procedure.

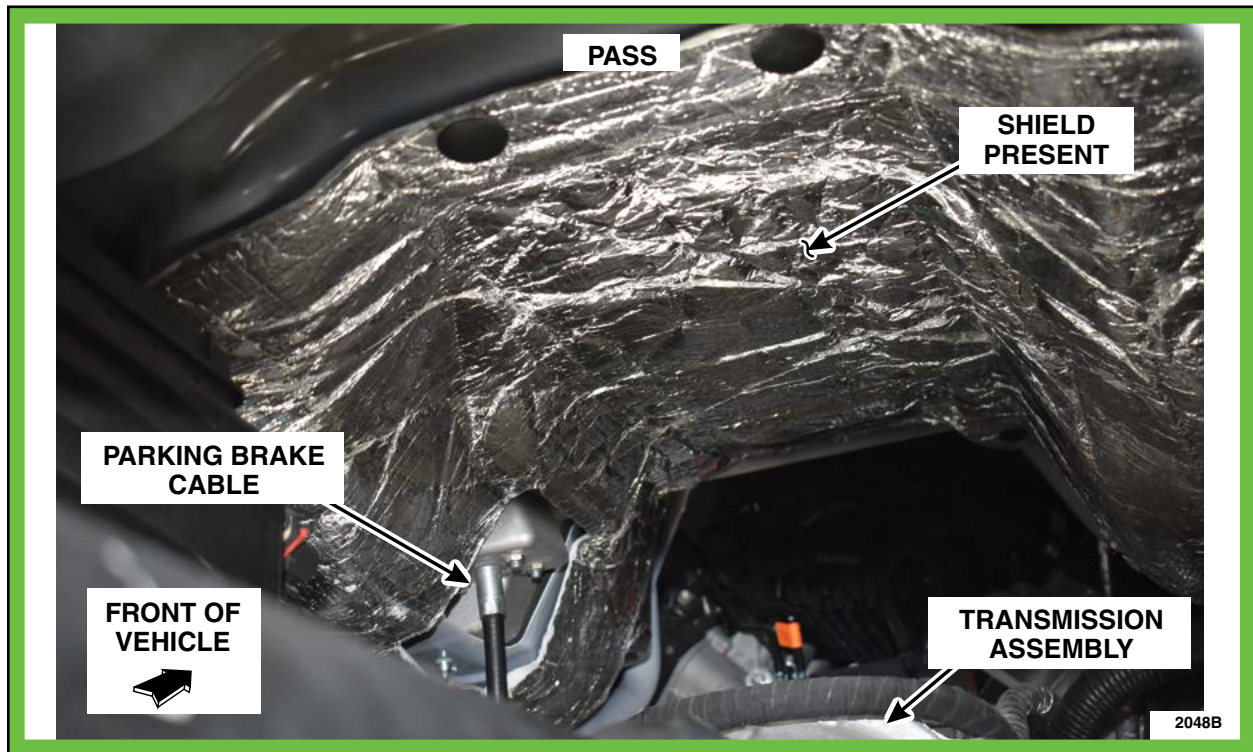

FIGURE 17



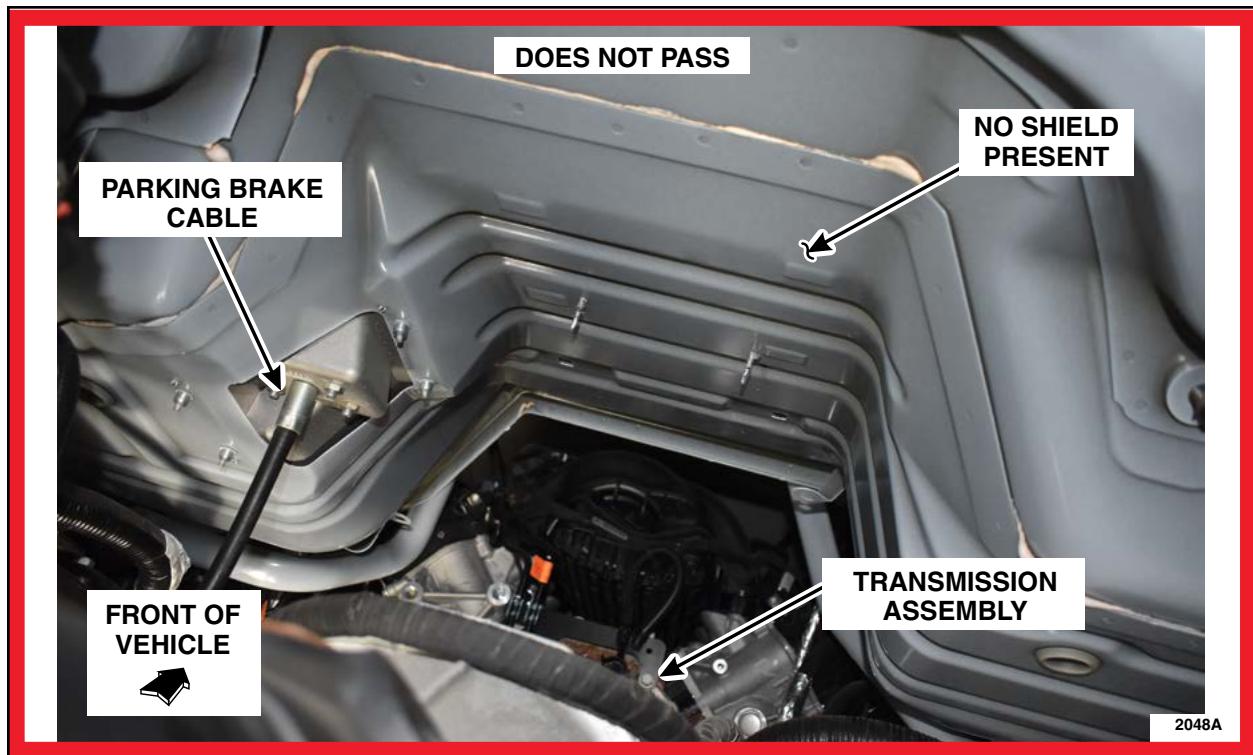

FIGURE 18

UNDERBODY HEAT SHIELD INSTALLATION PROCEDURE

IMPORTANT: Safety Glasses, Sleeves and Gloves are required to perform this repair.

NOTICE: Run the engine as little as possible and let the engine cool before performing the Service Procedure.

1. Before the heat shield is installed a cut must be made on the heat shield so that the shield can be positioned around the parking brake cable. Lay the heat shield down and locate the parking brake cable opening and the area in which to be cut, shown in Figure 19. Split the distance of the opening in half and using a pair of scissors, cut a straight line as indicated in Figure 19. Figure 20 shows a completed cut shield.





FIGURE 19



FIGURE 20



2. Fold the shield in half with the reflective sides touching. The end with the ears goes towards the front of the vehicle. See Figures 20 and 21.

NOTE: The heat shield is durable and can handle bending the sides to meet. However, care should still be taken not to deform or damage the heat shield. Heat tape can be used to fix any damage to the heat shield during installation.

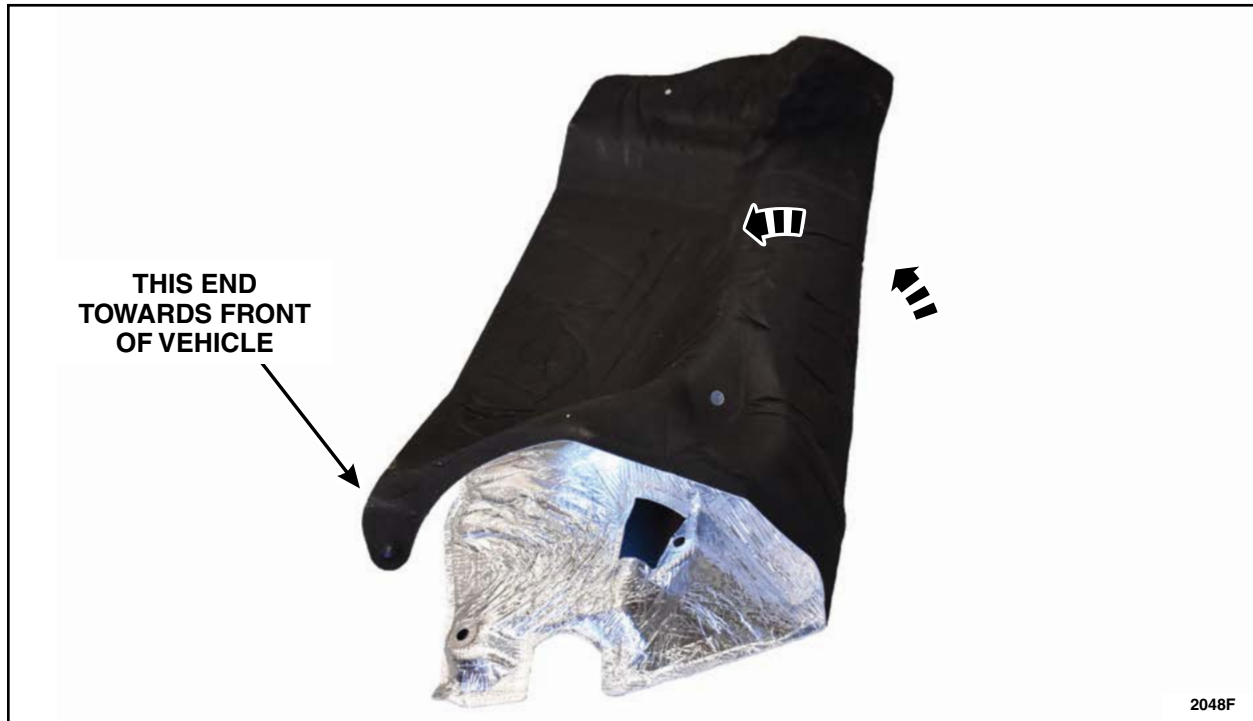

FIGURE 21



3. With the open portion of the folded shield facing down and parking brake cable opening on the drivers side of the vehicle, slide the folded shield along the left hand side of the drive shaft towards the front of the vehicle and up an over the transmission. See Figure 22.



FIGURE 22



4. Continue to work the shield forward until its over the transmission. Once over the transmission, begin to open the shield up and position it loosely in place. See Figure 23.

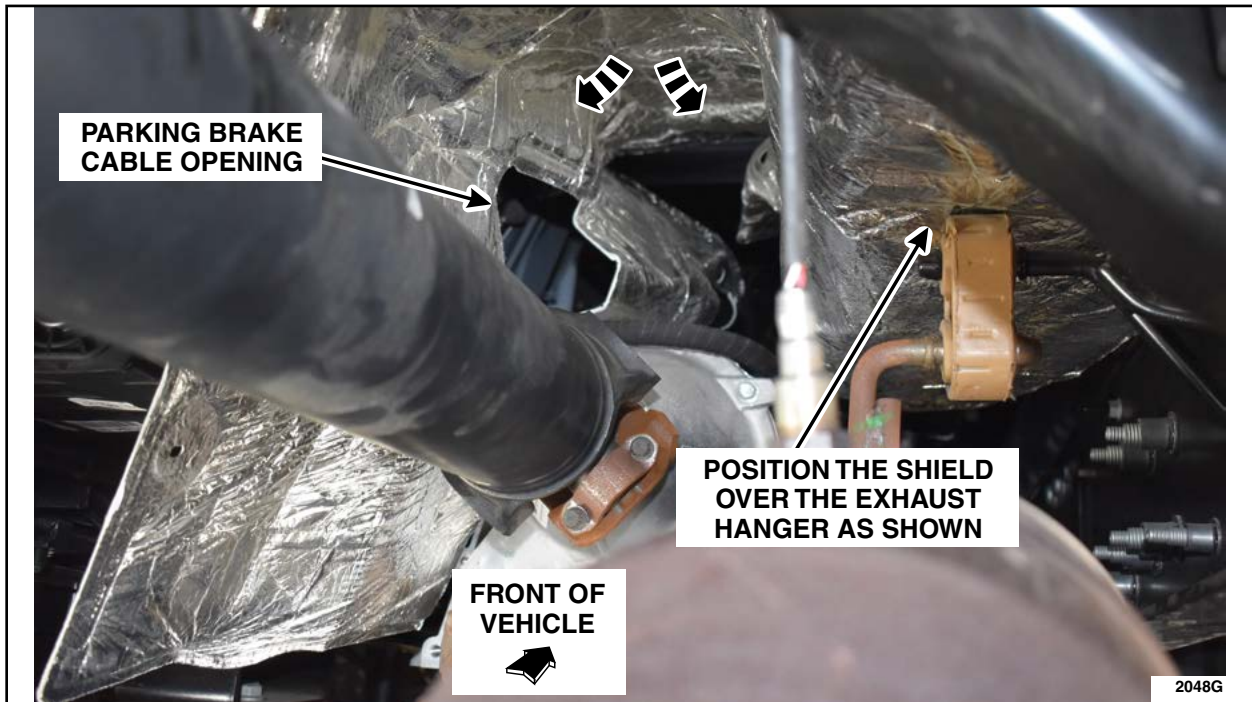

FIGURE 23

5. On the driver's side, position the shield around the parking brake cable and position the shield in place. See Figure 24.

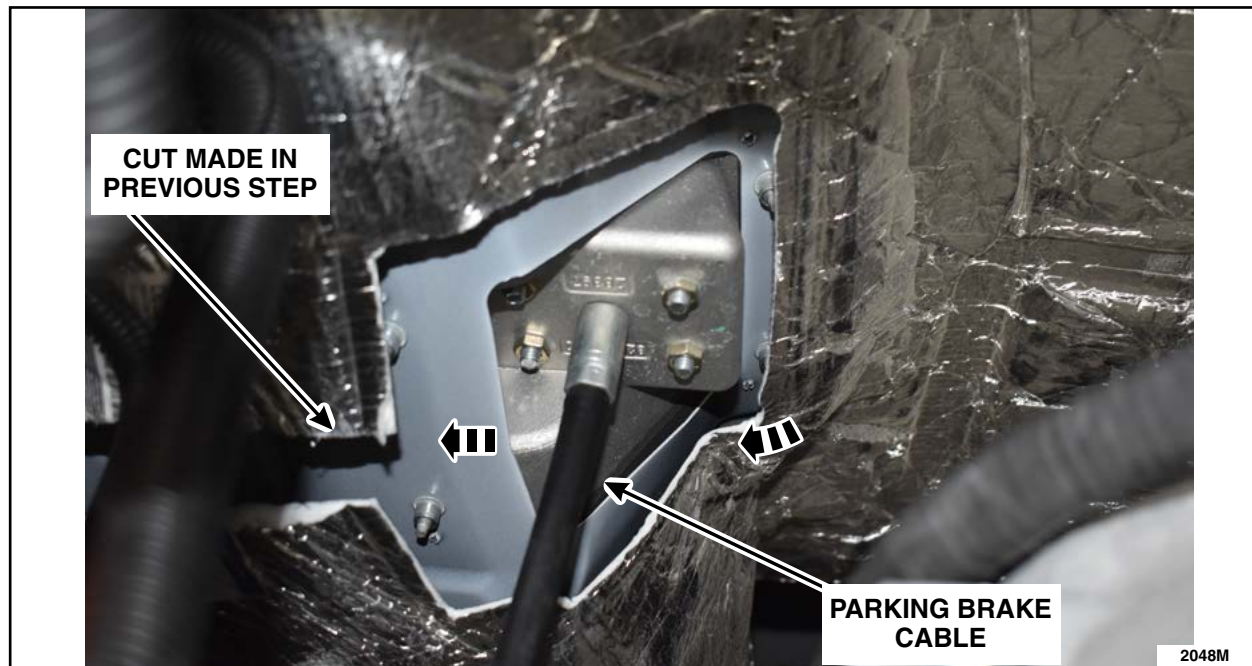

FIGURE 24



NOTE: The *new* heat shield comes equipped with 2 fasteners already in their respective retaining holes. All retaining holes for this shield are preexisting and once the shield is set into place will align with these retaining holes and conform to the underbody of the vehicle.

NOTE: The front ears on the *new* heat shield will go over the stiffening bar at the firewall when properly positioned.

6. Slide all 4 corners in their respective positions and install the one (1) rear alignment fastener that came installed on the heat shield as shown in Figure 25.



FIGURE 25



- Using the provided smaller shank push pins, install the three (3) remaining rear heat shield fasteners and using the provided larger shank push pins, install the three (3) remaining front heat shield fasteners. See Figure 26.



FIGURE 26

- Using a pair of scissors, cut a 9 in. strip of heat tape. Remove the protective backing from the heat tape and center it over the cut line for the parking brake cable (made in Step 1.) then press the sticky side on the shield. Continue to press the heat tape into the heat shield to prevent the two halves from separating. See Figure 27. Repair Complete.



FIGURE 27

