



David J. Johnson
 Director
 Service Engineering Operations
 Ford Customer Service Division

Ford Motor Company
 P. O. Box 1904
 Dearborn, Michigan 48121

March 12, 2020

- TO:** All U.S. Ford and Lincoln Dealers
- SUBJECT:** **Safety Recall 20S08 –Supplement #1**
 Certain 2015 - 2016 Model Year F-150 Vehicles Equipped with 3.5L GTDI Engines and Engine Block Heaters
 Engine Block Heater Cable Inspection
- REF:** **Application Performance Upgrade 19G01 – Supplement #4**
 Certain 2015 - 2019 Model Year F-150 and 2017 – 2019 Model Year F-Super Duty Vehicles Equipped with Engine Block Heaters
 Engine Block Heater Cable Replacement
- REF:** **Technical Service Bulletin 16-0003**
 2015-2016 Model Year F-150
 3.5L GTDI – No Start After Using Block Heater - Temperatures Below -15 °C (0 °F)
- REF:** **Technical Service Bulletin 19-2121**
 3.3L/3.5L Duratec/3.5L EcoBoost/5.0L - With Block Heater - Lack Of Heat When Operating In Temperatures Below -20°C (4°F) - Built On Or Before 1-Jan-2019
- REF:** **Technical Service Bulletin 19-2019**
 3.3L/3.5L Duratec/3.5L EcoBoost/5.0L - With Block Heater - Lack Of Heat When Operating In Temperatures Below -20°C (4°F)

AFFECTED VEHICLES

Vehicle	Model Year	Assembly Plant	Build Dates
F-150	2015-2016	Dearborn	July 31, 2014 through September 27, 2016
F-150	2015-2016	Kansas City	February 10, 2015 through October 15, 2016

Affected vehicles are identified in OASIS and FSA VIN Lists.

All vehicles in this program have had 19G01 completed.

New! REASON FOR THIS SUPPLEMENT

DO NOT USE – customers should be instructed to not use the engine block heater cord and provide them with Attachment IV: CUSTOMER INFORMATION SHEET – DO NOT USE – Risk of Fire.

REASON FOR THIS SAFETY RECALL

The 2015-16 MY F-150 3.5L GTDI engines were equipped with an engine block heater element located in the thermostat housing. Some customers reported poor engine cold-start concerns with the block heater in this location. Technical service bulletin (TSB) 16-0003 introduced a repair option to relocate the heater element to an alternate port in the engine block. This repair replaced the block heater cable with a shorter cable with heat protective tape and a heat shield, mainly to protect the cable from the heat from the turbocharger in this alternate location.

The released cables in 19G01 for 2015-2016 with 3.5L GTDI engine did not account for the different engine block mounting location and they were approximately 0.5m too long. Also, these cables did not contain the heat protection which was present on the TSB 16-0003 cable. A second TSB, TSB 19-2019 (superseded by 19-2121), was issued that relocated the engine block heater to an alternate location. It also included a replacement block heater cable that did not include heat protection, similar to the cable

used in TSB 16-0003. The absence of heat protection and the excess cable length in proximity to other engine components could result in cable damage. A damaged engine block heater cable can increase the risk of fire when the vehicle is parked, and the block heater cable is plugged into an electrical outlet.

New! SERVICE ACTION

Dealers are to inspect the left hand (LH) side of the block, behind the LH turbocharger assembly for immersion block heater element and cable:

- **PASS** - If the vehicle does not have an immersion block heater element installed on the left hand (LH) side of the block, behind the LH turbocharger assembly, no repair is necessary.
- **DOES NOT PASS, PART AVAILABLE:**
 - Rectangular connector: If the block heater cable and heater element have a rectangular connector, both the heater element and block heater cable will be replaced.
 - Round connector: If the block heater cable and heater element have a round connector, only the block heater cable will be replaced.
- **DOES NOT PASS, PART NOT AVAILABLE** - DISABLE the existing engine block heater cable so that it cannot be used.
 - ***DO NOT USE – customers should be instructed to not use the engine block heater cord and provide them with Attachment IV: CUSTOMER INFORMATION SHEET – DO NOT USE – Risk of Fire.***
 - ***This only applies when vehicle does not pass inspection, and updated cable is not available.***

This service must be performed on all affected vehicles at no charge to the vehicle owner.

OWNER NOTIFICATION MAILING SCHEDULE

Parts to repair this condition are currently not available in sufficient quantities to service all the affected vehicles. Owner letters are expected to be mailed the week of April 6, 2020. Dealers should inspect and repair any affected vehicles that arrive at their dealerships, whether or not the customer has received a letter.

PLEASE NOTE:

Federal law requires dealers to complete this recall service before a new vehicle is delivered to the buyer or lessee. Violation of this requirement by a dealer could result in a civil penalty of up to \$21,000 per vehicle. Correct all vehicles in your new vehicle inventory before delivery.

New! ATTACHMENTS

Attachment I: Administrative Information
Attachment II: Labor Allowances and Parts Ordering Information
Attachment III: Technical Information
Attachment IV: Customer Information Sheet – DO NOT USE ENGINE BLOCK HEATER CORD
Owner Notification Letters

QUESTIONS & ASSISTANCE

For questions and assistance, contact the Special Service Support Center (SSSC) via the SSSC Web Contact Site. The SSSC Web Contact Site can be accessed through the Professional Technician Society (PTS) website using the SSSC link listed at the bottom of the OASIS VIN report screen or listed under the SSSC tab.

Sincerely,

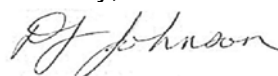

David J. Johnson

**NEW VEHICLE DEMONSTRATION / DELIVERY HOLD -
Safety Recall 20S08–*Supplement #1***
Certain 2015 - 2016 Model Year F-150 Vehicles
Equipped with 3.5L GTDI Engines and Engine Block Heaters
Engine Block Heater Cable Inspection

OASIS ACTIVATION

OASIS will be activated on February 24, 2020.

FSA VIN LISTS ACTIVATION

FSA VIN Lists will be available through <https://web.fsavinlists.dealerconnection.com> on February 24, 2020. Owner names and addresses will be available by April 21, 2020.

NOTE: Your FSA VIN Lists may contain owner names and addresses obtained from motor vehicle registration records. The use of such motor vehicle registration data for any purpose other than in connection with this recall is a violation of law in several states, provinces, and countries. Accordingly, you must limit the use of this listing to the follow-up necessary to complete this recall.

SOLD VEHICLES

- Ford has not issued instructions to stop selling/delivering or driving used vehicles under this safety recall. Owners should contact their dealer for an appointment to have their vehicles remedied as soon as practicable. Owners can continue to safely drive their vehicles.
- Immediately contact any of your affected customers whose vehicles are not on your VIN list but are identified in OASIS. Give the customer a copy of the Owner Notification Letter (when available) and schedule a service date.
- Correct other affected vehicles identified in OASIS which are brought to your dealership.
- Dealers are to prioritize repairs of customer vehicles over repairs of new and used vehicle inventory.

STOCK VEHICLES

- Correct all affected units in your new vehicle inventory before delivery.
- Use OASIS to identify any affected vehicles in your used vehicle inventory.

DEALER-OPERATED RENTAL VEHICLES

The Fixing America's Surface Transportation (FAST) Act law effective June 2016 prohibits a rental company from selling, renting or leasing vehicles subject to a safety or compliance recall. Please consult your legal counsel for legal advice.

TITLE BRANDED / SALVAGED VEHICLES

Affected title branded and salvaged vehicles are eligible for this recall.

OWNER REFUNDS

Refunds are not approved for this program.

**NEW VEHICLE DEMONSTRATION / DELIVERY HOLD -
Safety Recall 20S08 –*Supplement #1***
Certain 2015 - 2016 Model Year F-150 Vehicles
Equipped with 3.5L GTDI Engines and Engine Block Heaters
Engine Block Heater Cable Inspection

RENTAL VEHICLES

Rental vehicles are not approved for this program.

Ford has not issued instructions to stop driving used vehicles under this safety recall. Owners can continue to safely drive their vehicles until this safety recall has been completed.

Part shortages are not considered extenuating circumstances and do not qualify for rental vehicles with this program.

ADDITIONAL REPAIR (LABOR TIME AND/OR PARTS)

Additional repairs identified as necessary to complete the FSA should be managed as follows:

- For related damage and access time requirements, refer to the Warranty and Policy Manual / Section 6 – Ford & Lincoln Program Policies / General Information & Special Circumstances for FSA's / Related Damage.
- For vehicles within new vehicle bumper-to-bumper warranty coverage, no SSSC approval is required, although related damage must be on a separate repair line with the “Related Damage” radio button checked.
 - Ford vehicles – 3 years or 36,000 miles
- For vehicles outside new vehicle bumper-to-bumper warranty coverage, submit an Approval Request to the SSSC Web Contact Site prior to completing the repair.

CLAIMS PREPARATION AND SUBMISSION

- **Claim Entry:** Enter claims using Dealer Management System (DMS) or One Warranty Solution (OWS) online.
 - When entering claims, select claim type 31: Field Service Action. The FSA number (20S08) is the sub code.
 - For additional claims preparation and submission information, refer to the Recall and Customer Satisfaction Program (CSP) Repairs in the OWS User Guide.
- **Related Damage/Additional labor and/or parts:** Must be claimed as Related Damage on a separate repair line from the FSA with same claim type and sub code as described in Claim Entry above.

IMPORTANT: Click the Related Damage Indicator radio button.
- Provision for locally obtained supplies or misc. expense: Motorcraft Silicone Rubber TA-32 or equivalent or Motorcraft Thread lock TA-26 (for vehicles equipped with adaptive cruise control and approved by SSSC).
 - Program Code: 20S08
 - Misc. Expense: OTHER
 - Amount: Actual cost up to \$2.00
 - Estimated five vehicles per tube, twelve tubes per box.

**NEW VEHICLE DEMONSTRATION / DELIVERY HOLD -
Safety Recall 20S08–*Supplement #1***
Certain 2015 - 2016 Model Year F-150 Vehicles
Equipped with 3.5L GTDI Engines and Engine Block Heaters
Engine Block Heater Cable Inspection

New! LABOR ALLOWANCES**PASS**

Inspect left hand (LH) side of the block, behind the LH turbocharger assembly for immersion block heater element:

Description	Labor Operation	Labor Time
No immersion block heater element installed on the left hand (LH) side of the block, behind the LH turbocharger assembly No Repair Necessary	20S08A	0.3 Hours

DOES NOT PASS, PART AVAILABLE*

Inspect left hand (LH) side of the block, behind the LH turbocharger assembly for immersion block heater element;

Description	Labor Operation	Labor Time
RECTANGULAR CONNECTOR: - block heater cable and heater element have a <u>rectangular connector</u> : Replace heater element and block heater cable	20S08B (may claim 3 parts: cable, element, anti-freeze)	2.2 Hours
ROUND CONNECTOR: - block heater cable and heater element have a <u>round connector</u> : Replace block heater cable (DOES <u>NOT</u> INCLUDE REPLACING HEATER ELEMENT)	20S08C (may claim cable only)	1.2 Hours

*For labor operation codes 20S08B and 20S08C only – if vehicle is Lariat, King Ranch, Platinum Series, or Supercrew Limited Series equipped with adaptive cruise control, when you submit a VIN-specific Part Order to SSSC, you may also request the following:

- o additional labor time for the cruise control module (CCM) if equipped
- o TA-26 threadlock (may also obtain locally)
- o SSSC will confirm VIN is equipped with Adaptive Cruise Control with one of the following packages:
 - 50A Adaptive Cruise Control (option)
 - 68T Technology Package (option)
 - 502A Lariat (option)
 - 66A Lariat Series (option)
 - 601A King Ranch (option)
 - 701A Platinum Luxury (standard)

**NEW VEHICLE DEMONSTRATION / DELIVERY HOLD -
Safety Recall 20S08–*Supplement #1***
Certain 2015 - 2016 Model Year F-150 Vehicles
Equipped with 3.5L GTDI Engines and Engine Block Heaters
Engine Block Heater Cable Inspection

***New!* LABOR ALLOWANCES (continued)**

DOES NOT PASS, PART NOT AVAILABLE – INTERIM – DOES NOT CLOSE RECALL

Description	Labor Operation	Labor Time
Disable Engine Block Heater Cable (Interim Labor Operation) 1. Remove the three prongs from end of cable (that plugs into home extension cord). 2. Apply silicone rubber into cap and plug end, install cap back onto the block heater cable plug end. - This cannot be claimed with 20S08A <i>DO NOT USE – customers should be instructed to not use the engine block heater cord and provide them with Attachment IV: CUSTOMER INFORMATION SHEET – DO NOT USE – Risk of Fire.</i>	20S08DD (may claim silicone only)	0.3 Hours

PARTS REQUIREMENTS / ORDERING INFORMATION

SSSC Web Contact Site:

- Updated block heater cables are not yet available to repair all vehicles which require replacement. To place an order for the updated block heater cable, submit a VIN-specific part order contact via the SSSC Web Contact Site, along with three VIN-specific photos showing the following:
 - Block heater cable part number tag that is currently on vehicle
 - Round or Rectangular connector
 - Vehicle VIN tag or door label
- Part orders will be taken and released by SSSC as they become available, sufficient quantities to repair all vehicles are expected 2nd Quarter 2020.

Part Number	Description	Order Quantity	Claim Quantity
GL3Z-6B018-B	Block Heater Cable for 2015-2016MY F-150 3.5L GTDI Engine, with an immersion block heater.	1	1

Dealers will be notified via a DOES II communication if circumstances warrant a change in part supply strategy and when open ordering resumes.

**NEW VEHICLE DEMONSTRATION / DELIVERY HOLD -
Safety Recall 20S08–*Supplement #1***
Certain 2015 - 2016 Model Year F-150 Vehicles
Equipped with 3.5L GTDI Engines and Engine Block Heaters
Engine Block Heater Cable Inspection

PARTS REQUIREMENTS / ORDERING INFORMATION (continued)

Order the parts below through normal order processing channels:

Part Number	Description	Order Quantity	Claim Quantity
YF1Z-6A051-AA	Block Heater Element – Round <i>(can only be claimed with 20S08B labor operation)</i>	1	1
VC-3-B	Anti-freeze 1 Gallon Bottles <i>(can only be claimed with 20S08B labor operation)</i>	1	1
TA-32 or equivalent	Silicone Rubber (box of 12 tubes – 5 vehicles per tube) <i>(can only be claimed with 20S08DD labor operation)</i>	Claim as MISC. OTHER May Obtain Locally	
TA-26 or equivalent	Threadlock <i>(can only be claimed with adaptive cruise control)</i>		

Order your parts through normal order processing channels. To guarantee the shortest delivery time, an emergency order for parts must be placed.

DEALER PRICE

For latest prices, refer to DOES II.

PARTS RETENTION AND RETURN

Follow the provisions of the Warranty and Policy Manual, Section 1 - WARRANTY PARTS RETENTION AND RETURN POLICIES.

EXCESS STOCK RETURN

Excess stock returned for credit must have been purchased from Ford Customer Service Division in accordance with Policy Procedure Bulletin 4000.

CERTAIN 2015-2016 MODEL YEAR F-150 VEHICLES EQUIPPED WITH 3.5L GTDI ENGINES — BLOCK HEATER CABLE INSPECTION

NEW ! NOTE: For 2015-2016 model year F-150 vehicles equipped with 3.5L GTDI engines, engine block heaters were installed in two different locations:

1. Immersion block heater element located on the left hand (LH) side of the block, behind the LH turbocharger assembly.
2. Thermostat mounted block heater element (majority of vehicles will have this option).

Table of Contents

- Inspection Procedure.....	Pages 2-3
- Service Procedure.....	Pages 4-14
i. Removal Procedure.....	Pages 4-10
ii. Installation Procedure.....	Pages 11-14
- Disable Engine Block Heater Cable Procedure	Pages 15-16



INSPECTION PROCEDURE

All Vehicles

1. Raise the vehicle on a hoist. Please follow the Workshop Manual (WSM) procedures in Section 100-02.
2. Inspect the left hand (LH) side of the block, behind the LH turbocharger assembly, for the presence of an immersion block heater element. Is the vehicle equipped with an immersion style block heater?
See Figure 1 and the **NOTE** below.

Yes - Proceed to Step 3.
No - Inspection Complete.

NOTE: No repair is necessary if the vehicle is equipped with a Thermostat Block Heater.

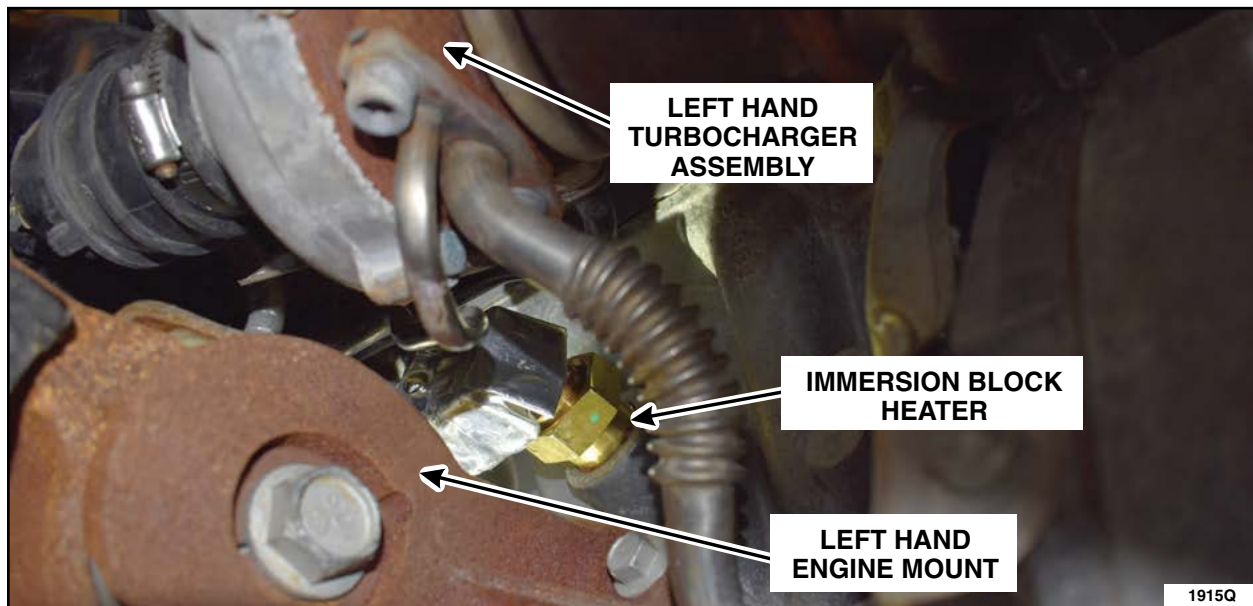

FIGURE 1



3. Does the immersion block heater cable have a rectangular or a round immersion element connector end? See Figures 2 and 3. Follow the repair procedure for the vehicles cable end shape.

For Rectangular End - Install a *new* immersion block heater element and block heater cable. Please follow the WSM procedures in Section 303-03C (immersion block heater element) and the Service Procedure on Page 4 (immersion block heater cable) of this campaign. **See WARNING below.**

For Round End - Install a *new* immersion block heater cable. Please follow the Service Procedure on Page 4 of this campaign. **See WARNING below.**

⚠ WARNING: If the immersion block heater cable is not available at the time of this repair, order the cable and perform the **Disable Engine Block Heater Cable Procedure** on Page 15. Failure to follow these instructions may increase the risk of overheated or melted wiring and/or fire.

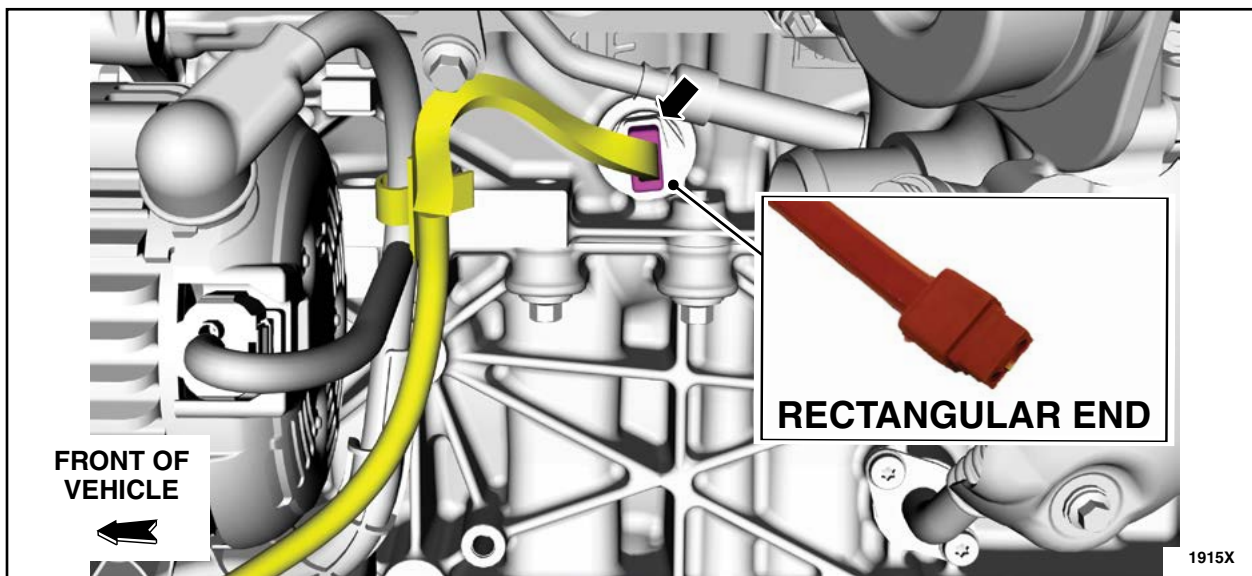

FIGURE 2

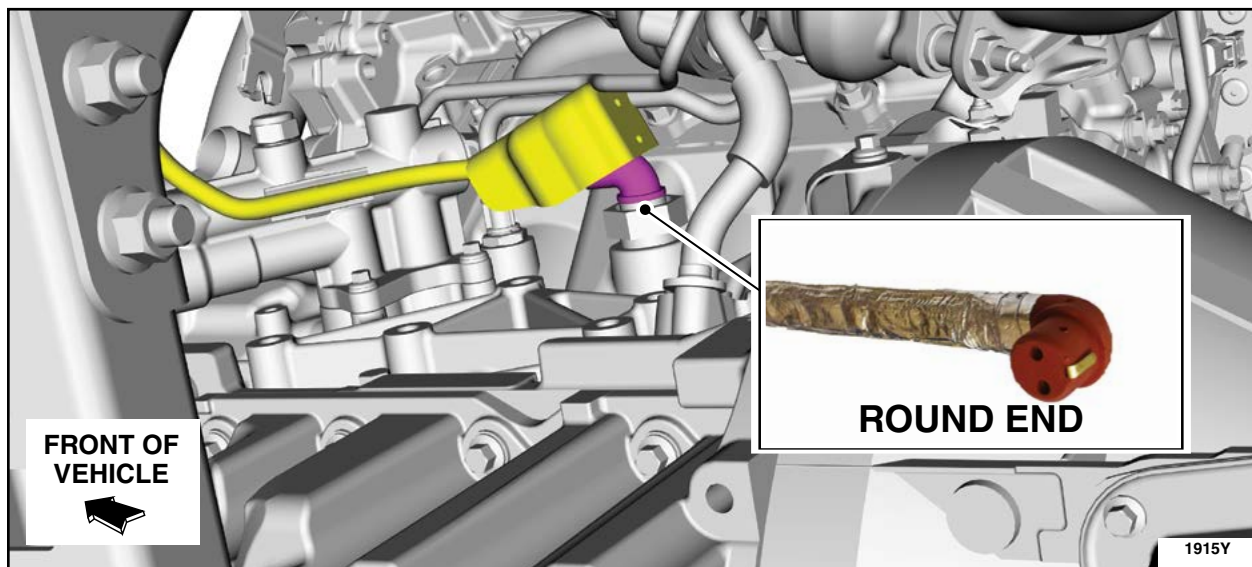

FIGURE 3



SERVICE PROCEDURE

⚠ WARNING: DO NOT INSTALL BLOCK HEATER CABLES THAT CONTAIN AN IN-LINE CONNECTOR FROM FSA PROGRAM 18S45.

REMOVAL PROCEDURE

Vehicles Equipped With Adaptive Cruise Control

NOTE: Do Not remove the CCM Bracket or the Front Bumper in the following Step.

1. Remove the Cruise Control Module (CCM). Please follow the Workshop Manual (WSM) procedures in Section 419-03.

NOTE: Remove any clips that remain in the bumper and reinstall them onto the front bumper trim panel.

Vehicles Not Equipped With Adaptive Cruise Control

2. Release the clips, detach the 110V plug end retainer and remove the front bumper trim panel. Remove any clips that remain in the bumper and reinstall them onto the front bumper trim panel. See Figure 4.

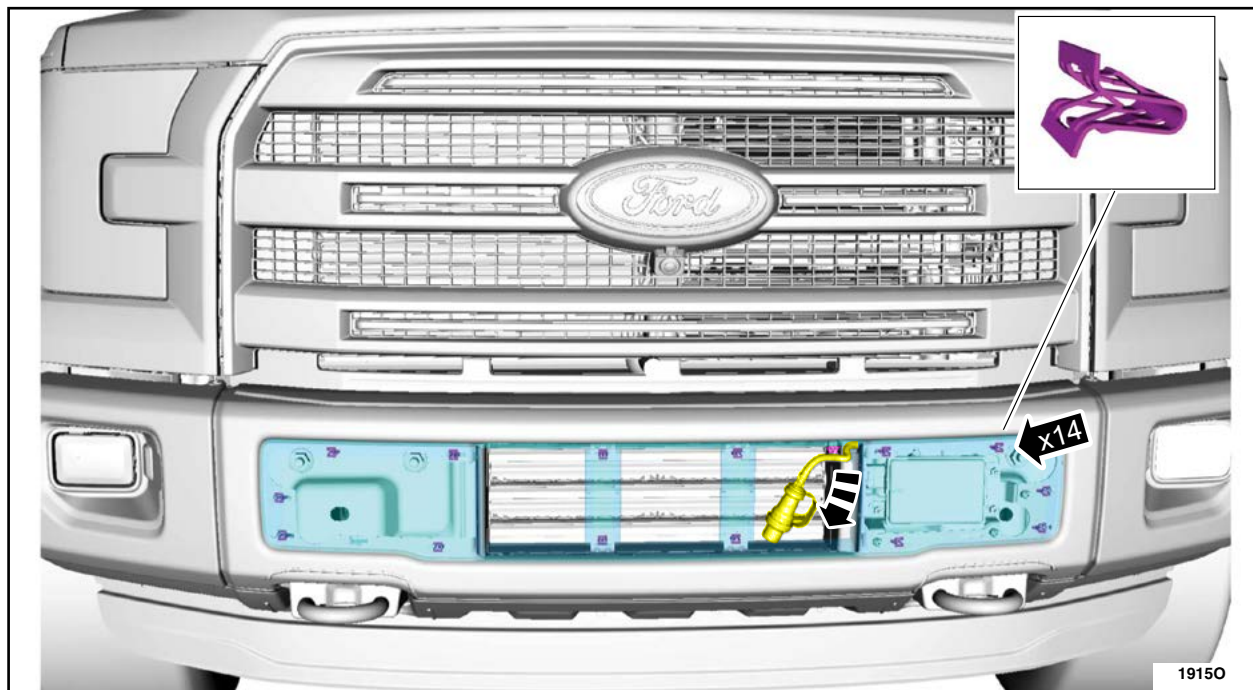

FIGURE 4



All Vehicles

3. Remove the left hand (LH) front fender splash shield. Please follow Workshop Manual (WSM) procedures in Section 501-02.
4. Remove the engine rear undershield. Please follow the WSM procedures in Section 501-02.
5. Disconnect the block heater electrical connector. Figure 5.
 - When installing the *new* block heater electrical connector, the heat shield will need to be positioned aside and positioned back over the electrical connector as needed to connect the block heater.

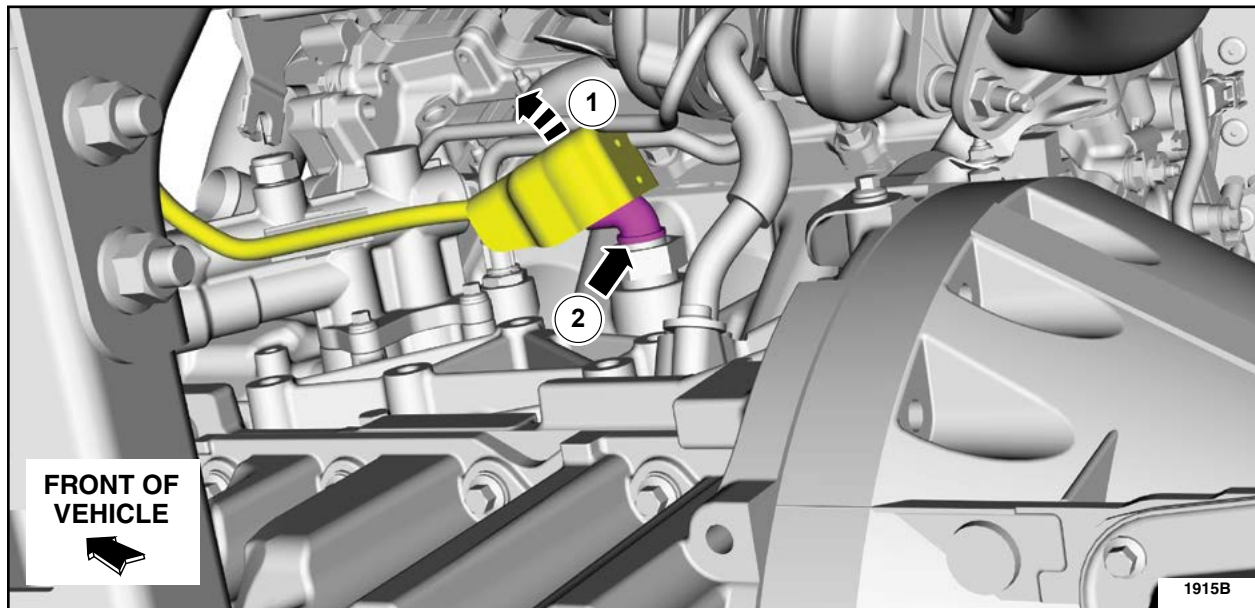

FIGURE 5



6. Release the block heater cable, small C-clip, from the generator wiring harness. See Figure 6.

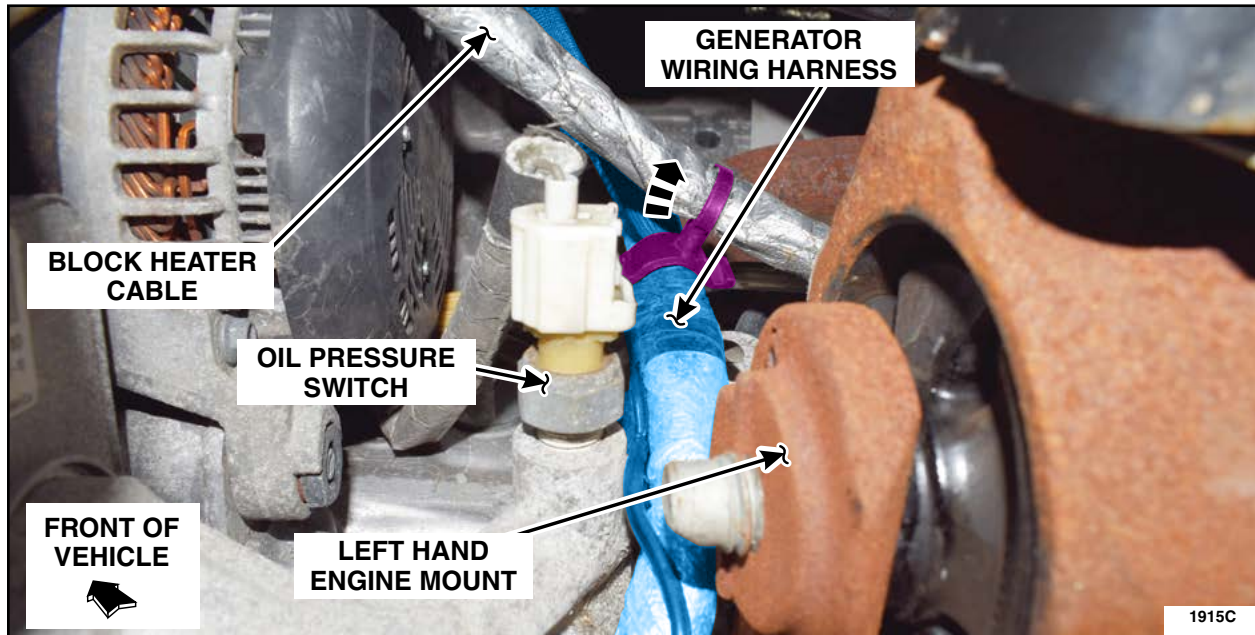

FIGURE 6



7. Release the large C-clip from the lower oil cooler coolant hose. See Figure 7.

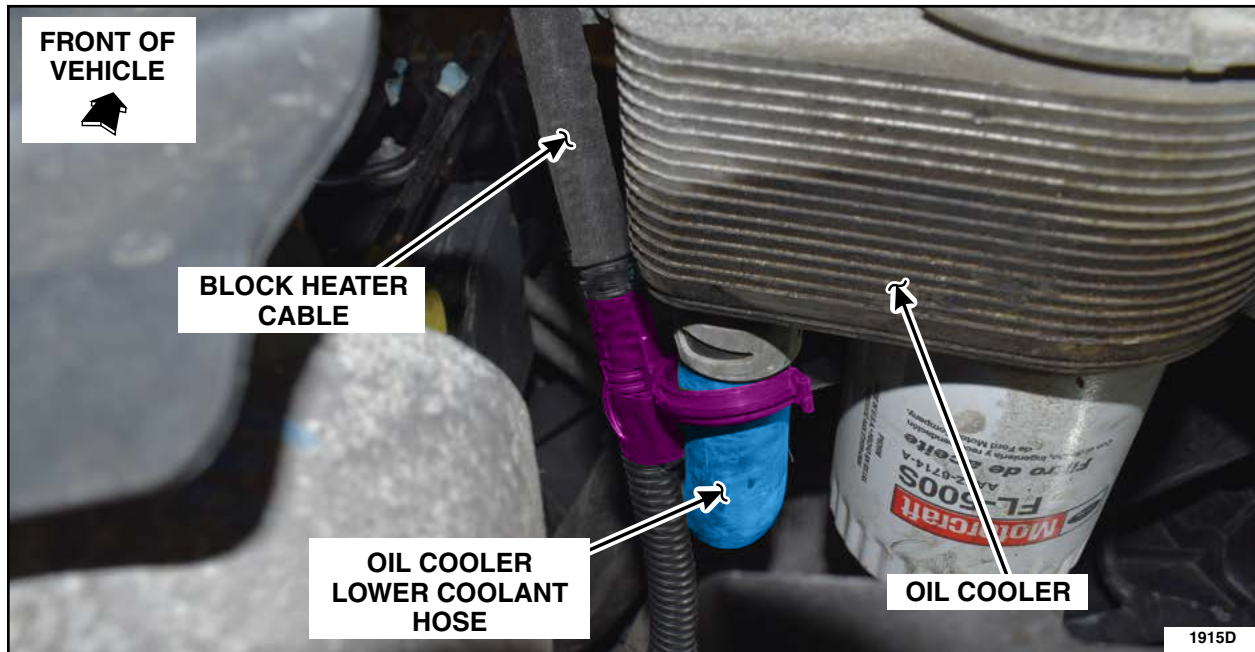

FIGURE 7

8. Release the block heater cable to frame retainer (a). Then, route the block heater cable over the LH motor mount toward the front of the vehicle (b). See Figure 8.

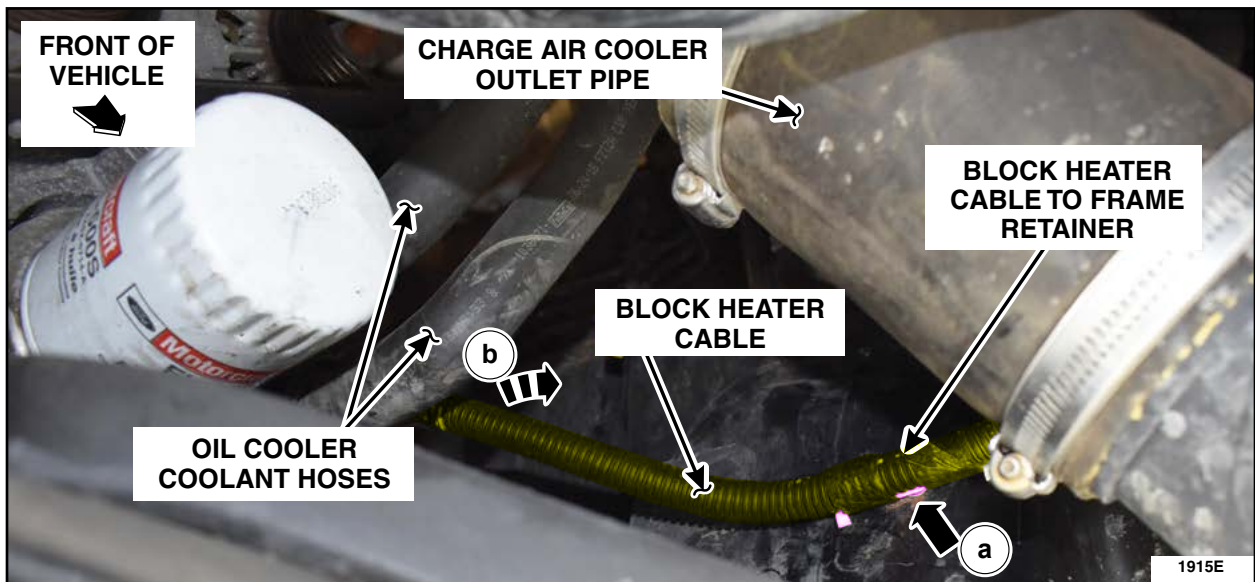

FIGURE 8



- If equipped, remove the heat shield by removing the reflective heat tape holding the heat shield to the block heater cable. See Figure 15.
- Remove and discard the small C-clip end by separating it from the tie strap base as shown in Figure 9.

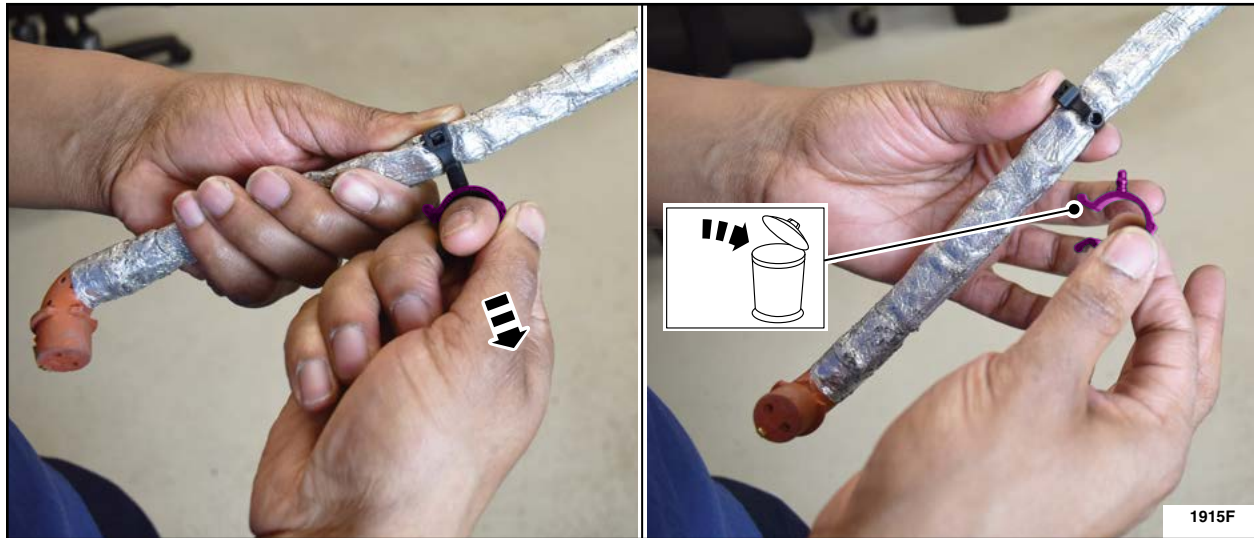

FIGURE 9

- Remove and discard the large C-clip, that was attached to the lower oil cooler coolant hose, from block heater cable by removing the tape holding it to the block heater cable. See Figure 10.

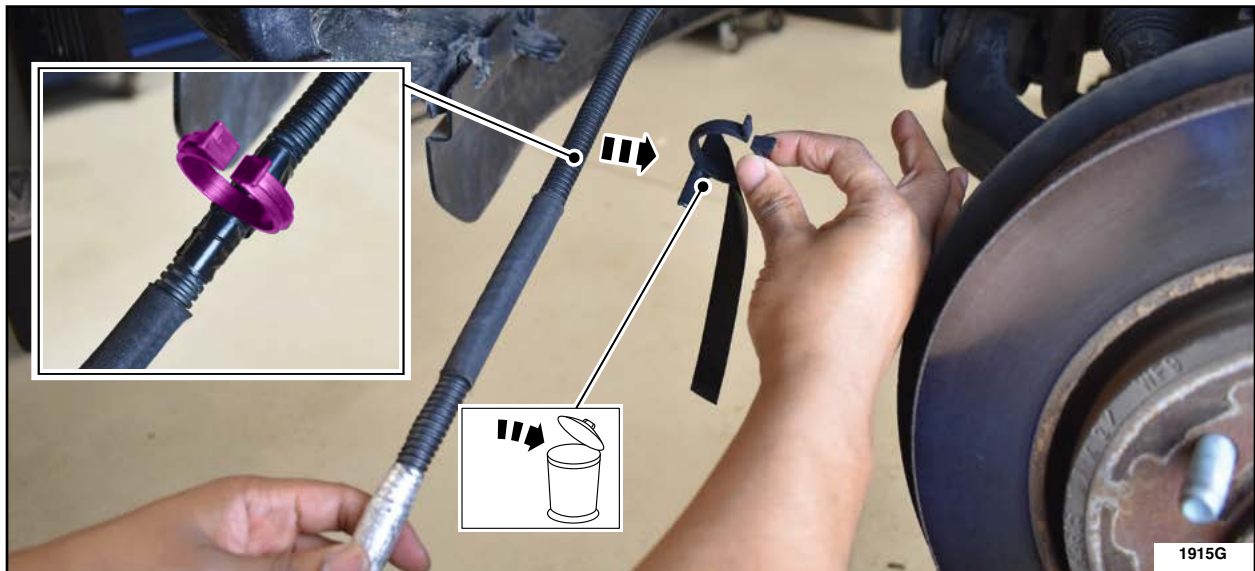

FIGURE 10



12. Detach the two (2) block heater cable retaining clips (a) from the left front frame rail and the one (1) cable retaining clip (b) from the bumper support bracket. See Figure 11.

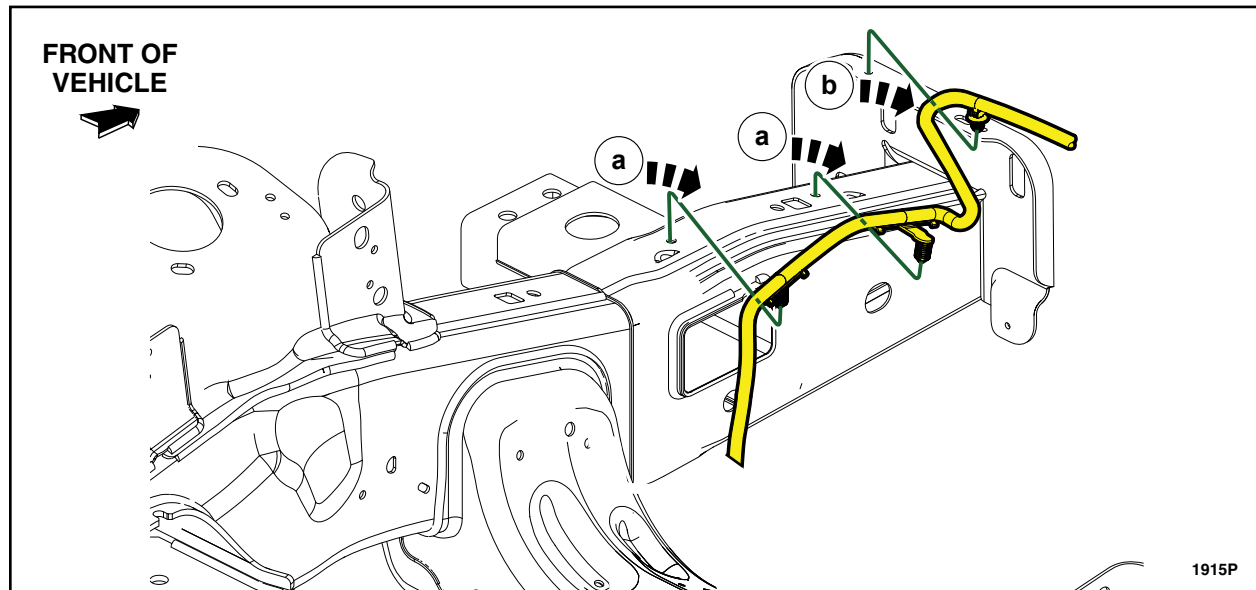

FIGURE 11

13. From the left front side of the vehicle, position the block heater cable out of the grill shutter air diverter slot and detach the retainer holding the block heater cable to bumper. See Figure 12.

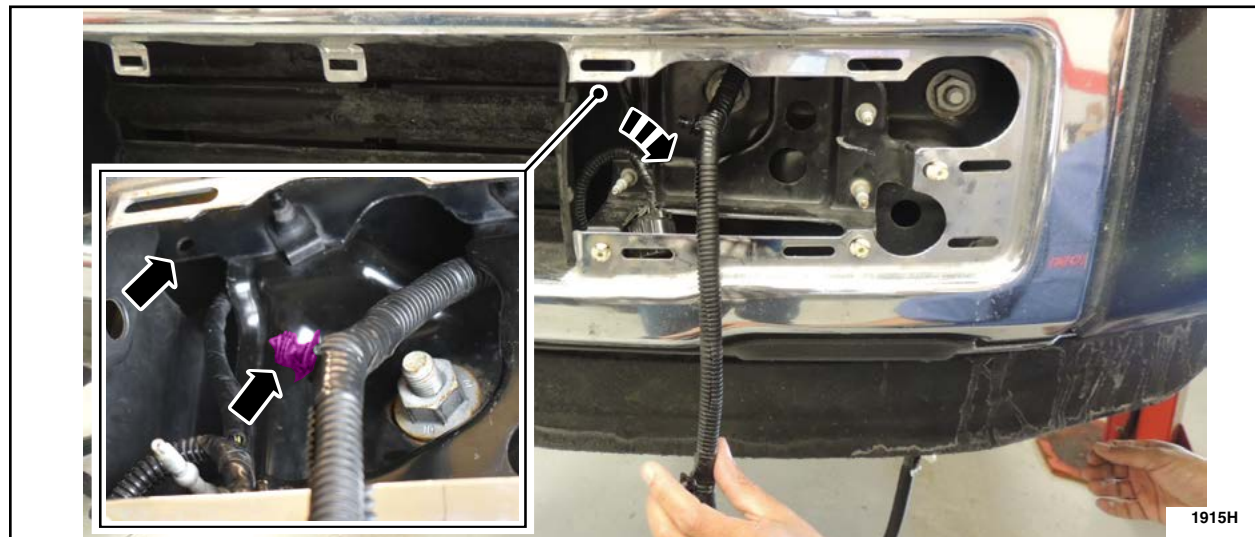

FIGURE 12



14. From the front of the vehicle, guide the block heater cable out through the front of the bumper. Remove and discard the original block heater cable. See Figure 13.

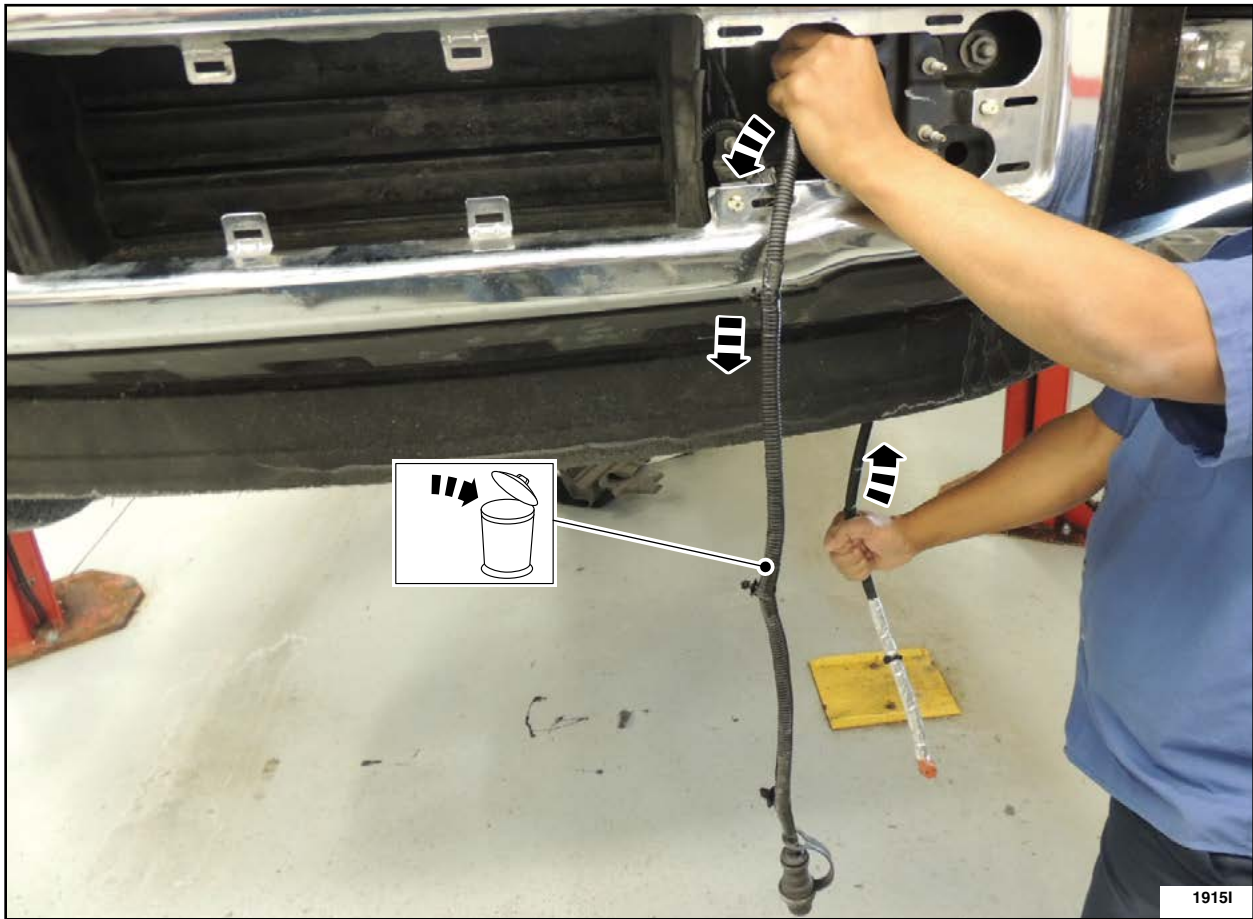

FIGURE 13



INSTALLATION PROCEDURE

NOTICE: Make sure the block heater cable is routed and secured away from rotating or hot components, or the cable can be damaged.

15. Before installing, lay out the *new* block heater cable. Mark the location of the large C-clip on the block heater cable as shown in Figure 14. Then, remove the tape holding the large C-clip to the block heater cable and set the clip to the side to be attach back to the block heater cable later in this procedure. See Figure 14.



FIGURE 14

16. Carefully remove the reflective heat tape holding the heat shield to the block heater cable. Then, remove the heat shield and reflective heat tape and set aside to be reattached back to the block heater cable later in this procedure. See Figure 15.

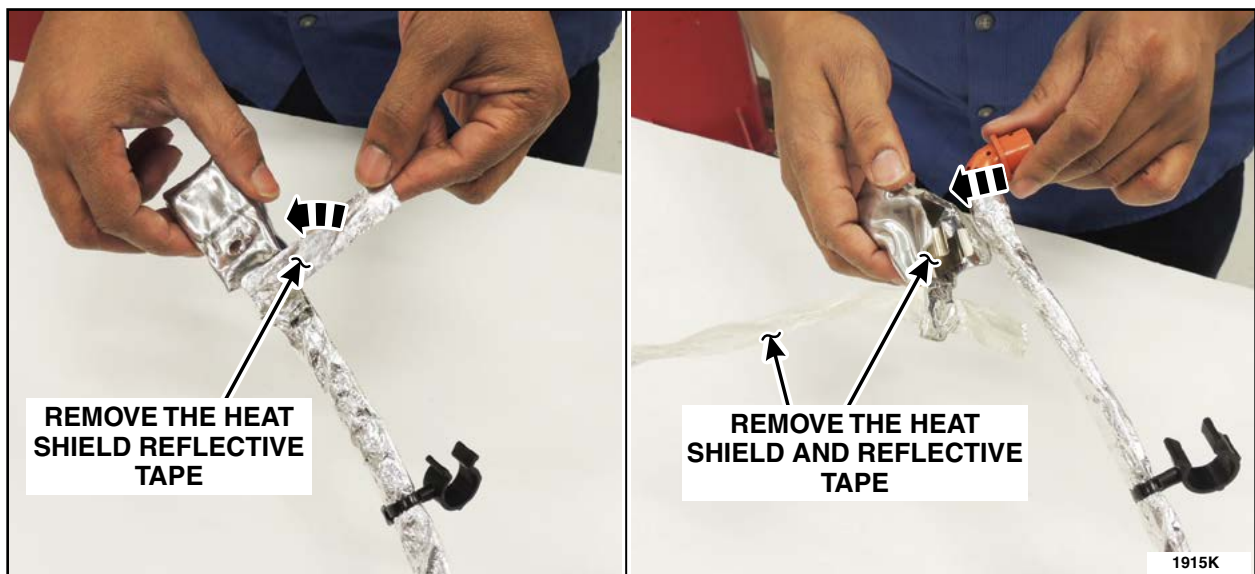

FIGURE 15



17. Remove the small cable C-clip by separating the clip from the zip tie base. Set aside the clip to be reinstalled later in this procedure. See Figure 16.

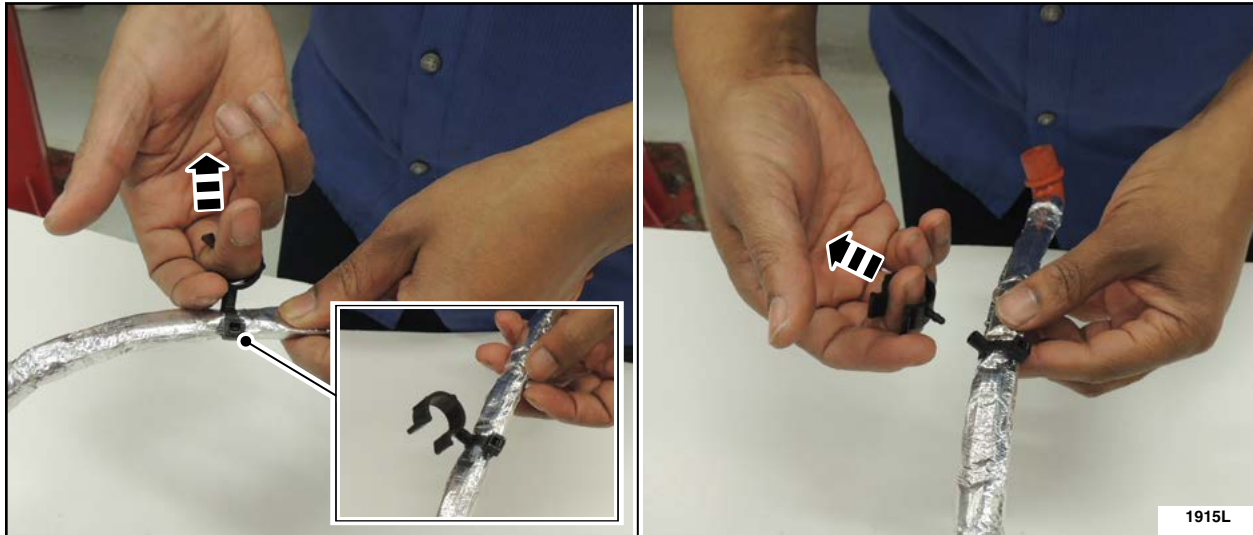

FIGURE 16

18. Route the block heater cable, starting with the block heater element (orange) connector, through the left front side of the bumper. See Figure 17.

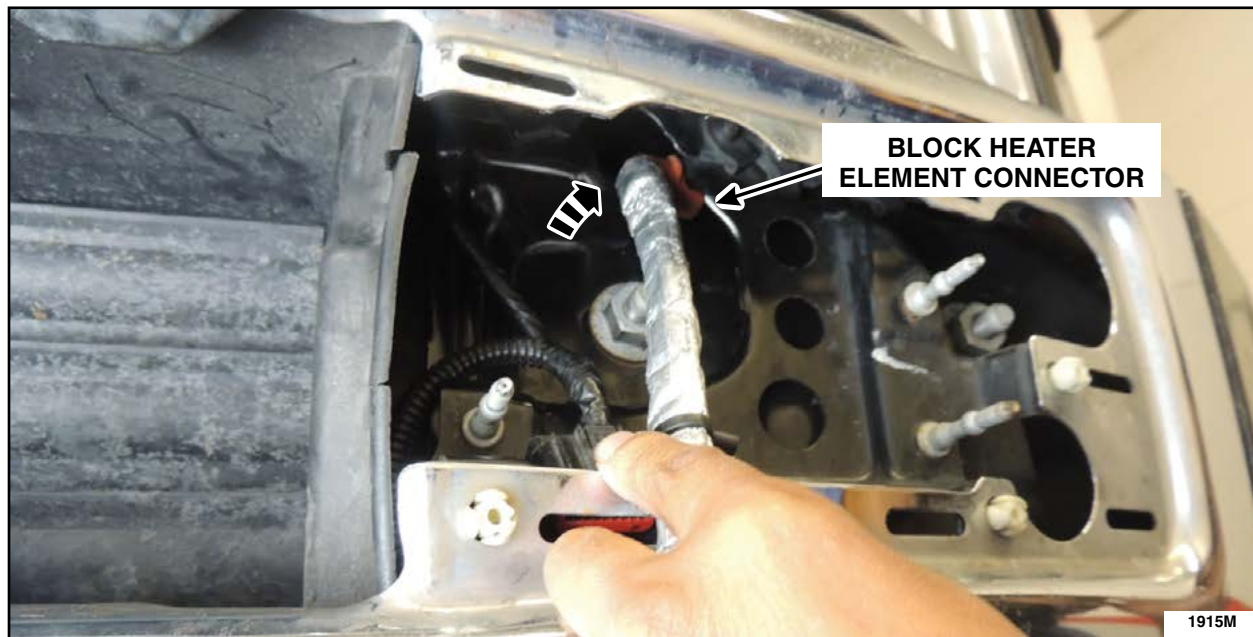

FIGURE 17



19. Continue to route the block heater cable until at least half of the cable is routed through the front bumper. See Figure 13.
20. Attach the two (2) block heater cable retaining clips (a) to the left front frame rail and one (1) cable retaining clip (b) to the bumper support bracket. See Figure 11.
21. Using electrical tape, retape the large C-clip to the block heater cable where it was previously marked for removal. See Figure 14.
22. Secure the small C-clip back into the zip tie base on the block heater cable. See Figure 16.
23. Using the original reflective heat tape, install and retape the heat shield around the block heater element connector end. See Figure 15.
24. Route the block heater cable toward the inboard side of the left front frame rail and over the LH engine mount toward the block heater element. Then, attach the block heater cable to frame retainer. See Figure 8.
25. Attach the large C-clip to the lower oil cooler coolant hose. See Figure 7.
26. Attach the small C-clip to the generator wiring harness. See Figure 6.
27. Connect the block heater electrical connector and position the heat shield back over the block heater connector. See Figure 5.
28. From the left front side of the vehicle, attach the retainer holding the block heater cable to bumper as shown in Figure 12.
29. Route the block heater cable through the upper slot in the grill shutter air diverter as shown in Figure 18.



FIGURE 18



30. Install the engine rear undershield. Please follow the WSM procedures in Section 501-02.
31. Install the LH front fender splash shield. Please follow the WSM procedures in Section 501-02.

Vehicles Not Equipped With Adaptive Cruise Control

32. Attach the block heater cables 110V plug end retainer and install the front bumper trim panel.
See Figure 4.

Vehicles Equipped With Adaptive Cruise Control

33. Install the CCM. Please follow the WSM procedures in Section 419-03.



⚠ WARNING: ONLY PERFORM THE DISABLE ENGINE BLOCK HEATER CABLE PROCEDURE IF THE VEHICLE REQUIRES A BLOCK HEATER CABLE REPLACEMENT AND NO PARTS ARE AVAILABLE TO COMPLETE THE REPAIR.

DISABLE ENGINE BLOCK HEATER CABLE PROCEDURE

- DISABLE the existing engine block heater cable so that it cannot be used.
- Disabling the Engine Block Heater Cable will not close this Safety Recall.

1. Remove the three prongs on the block heater cable using pliers, by bending the prongs back and forth to break the prongs off. See Figure 19.

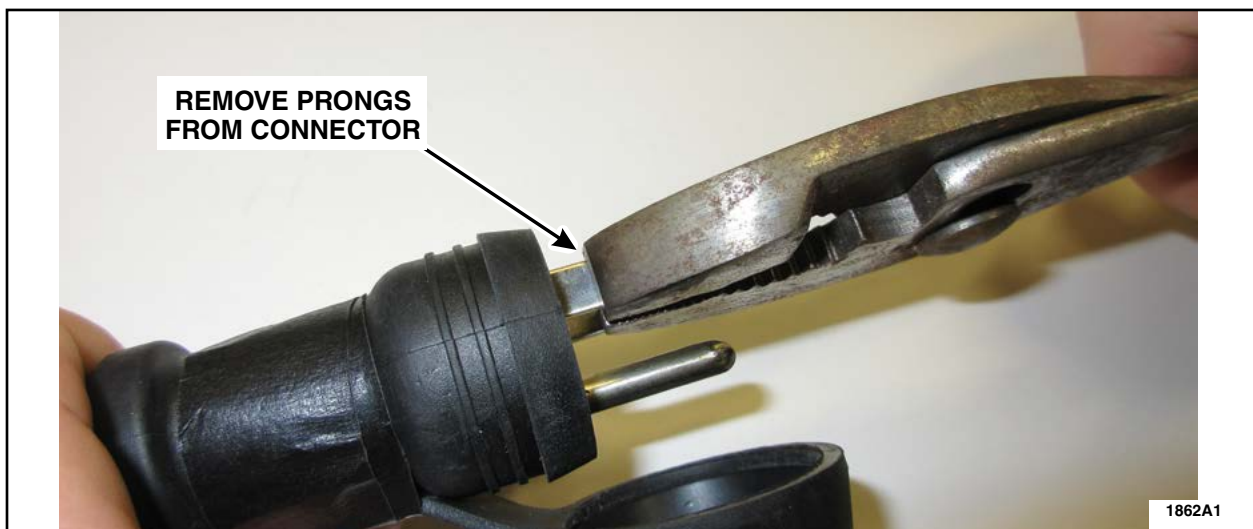

FIGURE 19

2. Apply Motorcraft silicone sealant TA-32 or equivalent to the cap and plug end. See Figure 20.

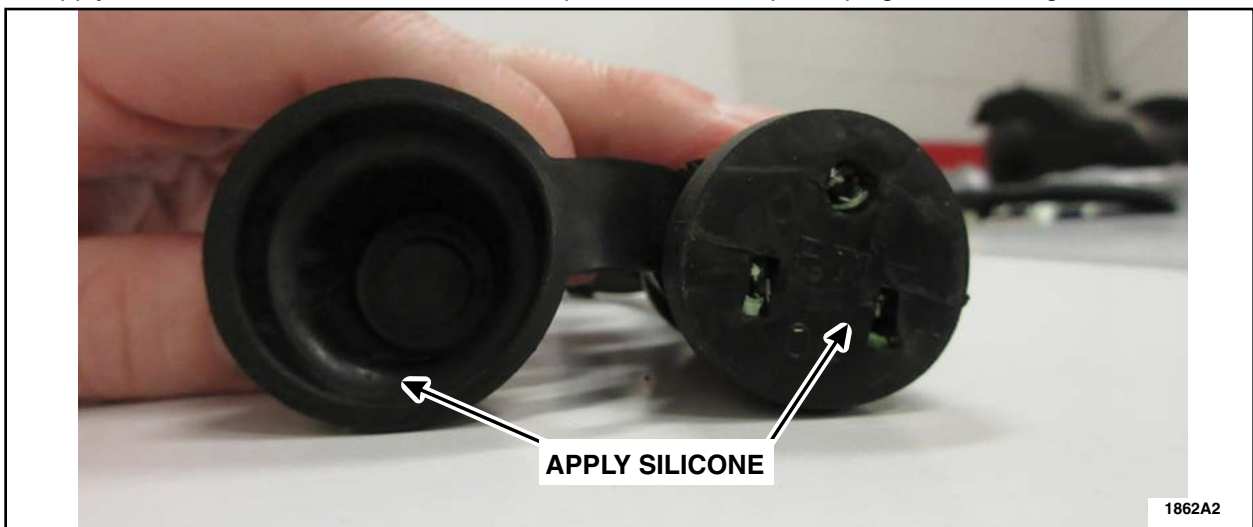

FIGURE 20



3. Install the cap back onto the block heater cable plug end. See Figure 21.

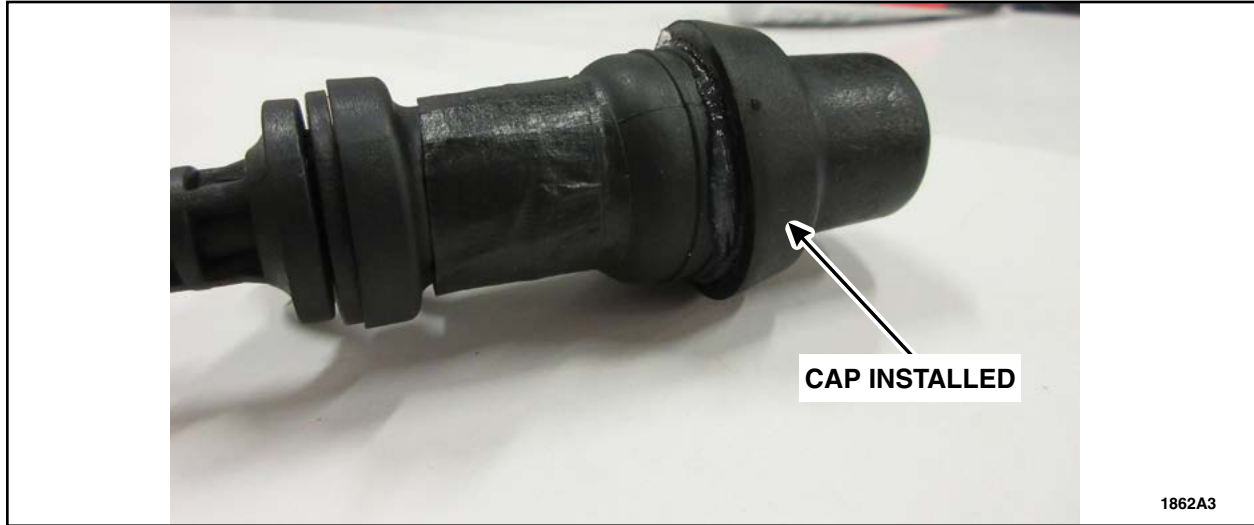

FIGURE 21



**Engine Block Heater Cord Replacement
Customer Information Sheet – DO NOT USE – RISK OF FIRE**

 **WARNING: DO NOT USE THE ENGINE BLOCK HEATER IN YOUR VEHICLE DUE TO THE RISK OF AN ENGINE COMPARTMENT FIRE AND/OR PROPERTY DAMAGE.**

Ford Motor Company is recalling certain 2015 - 2016 Model Year F-150 Vehicles Equipped with 3.5L GTDI Engines and Engine Block Heaters. The engine block heater cord will be disabled under Safety Recall 20S08 if replacement parts are not available.

When replacement parts become available, Ford Motor Company will notify you via mail to schedule a service appointment with your dealer to replace your engine block heater cord assembly.

Again, we apologize for the inconvenience this situation causes and assure you that we are doing everything possible to expedite resolution.

Sincerely,

Ford Motor Company
Ford Customer Service Division