



CR180 – Breather valve kit part no.69929001A installation

1199 Superleggera Model Year 2014

1299 Superleggera Model Year 2017

1299 Panigale R Final Edition Model Year 2018

Panigale R Model Year 2015-2017

Safety Recall Bulletin SRV-RCL-19-002

Date: September 26, 2019

To: Dealer Principal, General Manager, Service Manager, North American Dealer Network

From: Richard Kenton, Technical Director
Eric Bradley, Technical Training and Publications Manager

Dear Dealers,

Based on continued quality tests and service reports, it was identified that the engine vapor breather system could operate incorrectly, with possible consequent leakage of engine oil from the Airbox breather tube.

All motorcycles involved in this Safety Recall Campaign will be upgraded by installing the kit part no.69929001A characterized by a new completely redesigned cyclone separator to prevent the operational issues.

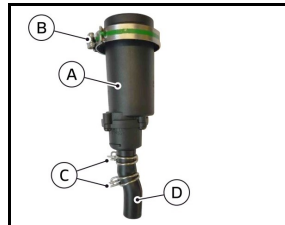

Application

The exact list of the frame numbers subject to the CR180 is available on the DCS, in sections:

VEHICLE HISTORY		It is possible to search by individual frame number.
CAMPAIGNS		It is possible to search for all the frame numbers that you received from Ducati Motor Holding.

1299 PANIGALE SUPERLEGGERA RACING MATT RED 2017 CAL DMH					
VIN #	ZDMHAAJW2HB00 XXX	ENGINE #	AAJH0 XXX	WTY END DATE	03/12/2020
END CUSTOMER	SMIECH	MANUFACT DATE	09/22/2017	INVOICE	10/19/2017
WARRANTY TYPE	Standard Warranty	STANDARD WTY START DATE	03/13/2018	LAST MILEAGE	10 MI

ATTENTION: YOU HAVE 1 PENDING RECALL CAMPAIGNS

N	TYPE	ID NUMBER	REPAIR DATE	DEFECT	CAUSAL PART	DEALER	MILEAGE
1	RECALL	CR 180		SRV-RCL-19-002 Breather Valve Installation		<input type="button" value="VIEW"/> <input type="button" value="APPLY"/>	



CR180 – Breather valve kit part no.69929001A installation

1199 Superleggera Model Year 2014

1299 Superleggera Model Year 2017

1299 Panigale R Final Edition Model Year 2018

Panigale R Model Year 2015-2017

Safety Recall Bulletin SRV-RCL-19-002

Customer Impact

All motorcycles in dealer stock ('to be registered' or 'already registered') and awaiting delivery to final customers must undergo this procedure during pre-delivery operations, before delivery to the final customer. All motorcycles already delivered to final customers must undergo this procedure at the next service appointment.

Parts distribution

Kit part no. 69929001A, required to complete the upgrade in accordance with this Safety Recall Campaign must be ordered individually per VIN by the dealer. The required tie straps can be sourced locally and do not need to be ordered through DCS

Special tool part no. 889450108 must NOT be ordered by the dealer. They will be distributed by the Ducati North America directly to each dealer.

Warranty claim reimbursement rules

The reimbursement for performing this Safety Recall Campaign will take place following the normal warranty claim procedure, using the DCS "**Vehicle History**" section. The warranty claim is pre-filled and is identified as **CR180**.

You shall be reimbursed for the cost of the components required and supplied for the repairs (Breather kit part no. 69929001A), and **2h:30 minutes (25 labor units)** labor time that includes the time necessary for:

- Vehicle reception
- Installation of the Breather kit part no. 69929001A
- Soft cleaning of the vehicle



CR180 – Breather valve kit part no.69929001A installation

1199 Superleggera Model Year 2014

1299 Superleggera Model Year 2017

1299 Panigale R Final Edition Model Year 2018

Panigale R Model Year 2015-2017

Safety Recall Bulletin SRV-RCL-19-002

Table of Contents

	Page
Introduction	1
Application	1
Customer Impact	2
Parts Distribution	2
Warranty reimbursement rules	2
Spare Parts	4
Service Solution	5
Additional Requirements and Notes	17
Customer Letter Example	18



CR180 – Breather valve kit part no.69929001A installation

1199 Superleggera Model Year 2014

1299 Superleggera Model Year 2017

1299 Panigale R Final Edition Model Year 2018

Panigale R Model Year 2015-2017

Safety Recall Bulletin SRV-RCL-19-002

Spare Parts

The kit part no.69929001A is made up of the following components:

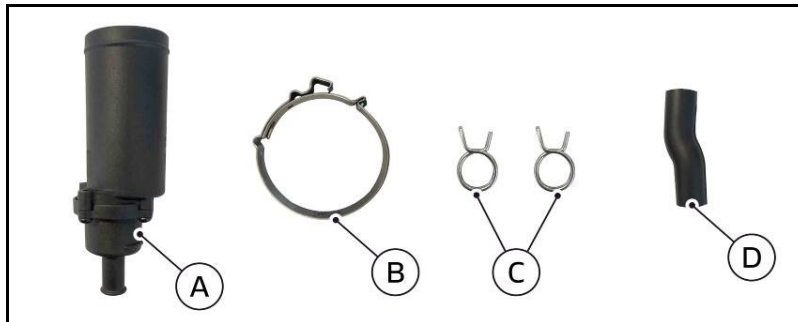

Part no.	Reference	Description	Quantity
69929001A	A	Cyclone separator	1
	B	Click clamp	1
	C	Clamps	2
	D	Rubber hose	1



ATTENTION

To install the Breather valve kit part no.69929001A, it is necessary to use the special buffer part no.889450108 that will be sent free of charge (1 per each Dealer).

Do NOT enter any order on the DCS for the purchase of the above-mentioned special tool.





CR180 – Breather valve kit part no.69929001A installation

1199 Superleggera Model Year 2014

1299 Superleggera Model Year 2017

1299 Panigale R Final Edition Model Year 2018

Panigale R Model Year 2015-2017

Safety Recall Bulletin SRV-RCL-19-002

Service Solution



WARNING

To ensure the correct execution of the operation within the provided labor time to carry out the updates, it is necessary to follow the sequence indicated in the following instructions



NOTE

The procedure for the installation of the Breather valve kit part no.69929001A indicated below, refers to the 1299 Superleggera model. Proceed in the same way also for the other models involved in this Safety Recall Campaign.

1. Position the vehicle on the rear paddock stand
2. Remove the LH side fairing (see Sec. 5: "Fairing installation – Fairing" of the Workshop Manual)
3. Remove the ignition switch cover (see Sec. 5: "Fairing installation – Headlight Fairing" of the Workshop Manual)
4. Remove both right and left air conveyer covers (see Sec. 5: "Fairing installation – Headlight Fairing" of the Workshop Manual)
5. Remove the battery cover (1)

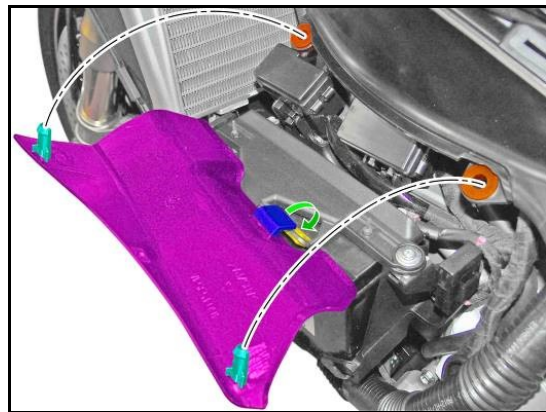



CR180 – Breather valve kit part no.69929001A installation

1199 Superleggera Model Year 2014

1299 Superleggera Model Year 2017

1299 Panigale R Final Edition Model Year 2018

Panigale R Model Year 2015-2017

Safety Recall Bulletin SRV-RCL-19-002

6. Remove the 3 M5x22 screws (2) and the relevant spacers (3) securing the electrical components support
7. Remove the 2 big self-locking ties (4)

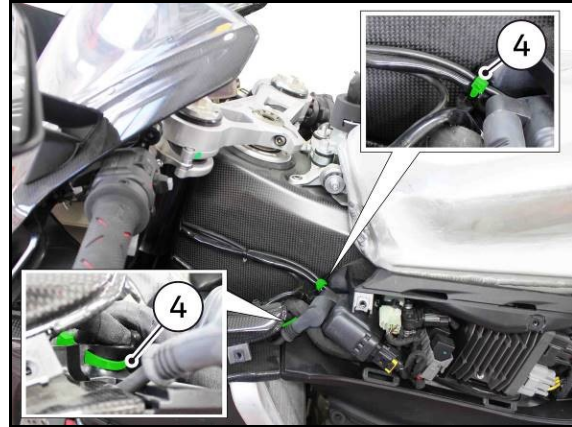
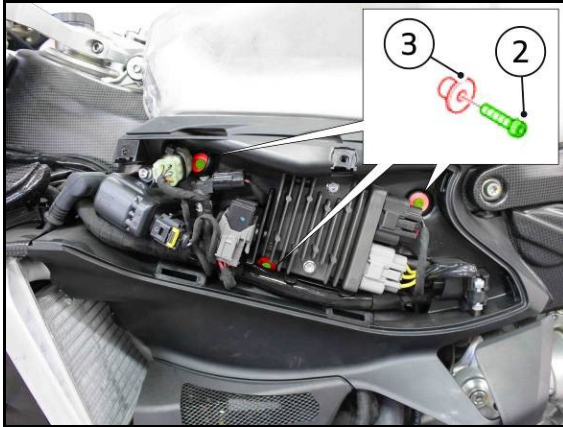

8. Disconnect the spark plug cable (5) from the horizontal cylinder coil
9. Remove the big self-locking tie (6) securing the ignition switch connector (7) to the electrical components support and disconnect the connector

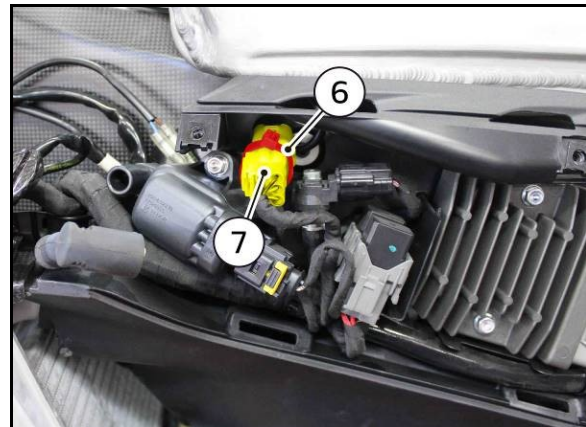
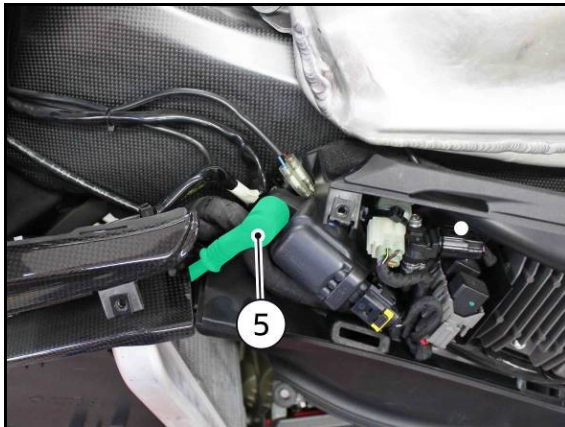



CR180 – Breather valve kit part no.69929001A installation

1199 Superleggera Model Year 2014

1299 Superleggera Model Year 2017

1299 Panigale R Final Edition Model Year 2018

Panigale R Model Year 2015-2017

Safety Recall Bulletin SRV-RCL-19-002

10. Remove the **M6x22 screw (8)** securing the pressure sensor to the electrical components support and slide **nut (9)** out
11. Remove the **2 connectors (10)** of the voltage regulator

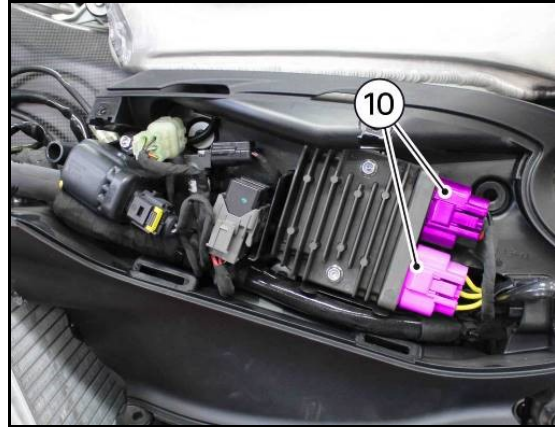
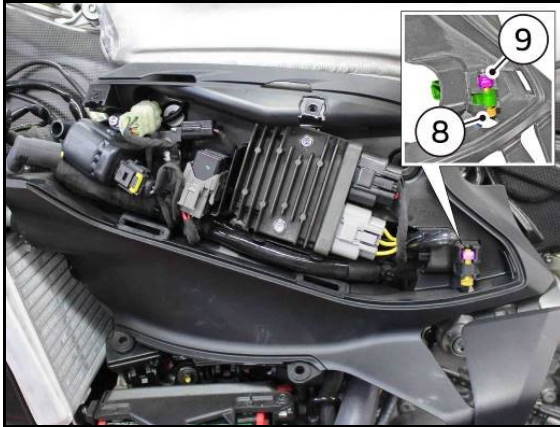

12. Remove the rider seat (see Sec.5: "Fairing installation – Seat" of the Workshop Manual)
13. Remove the **2 M6x14 screws (11)** that retain the fuel tank **bracket (12)** to the rear subframe
14. Lift the fuel tank and keep it lifted using a suitable support taking care not to damage components with the support or impinge the fuel tank into any other components, as shown in the figure

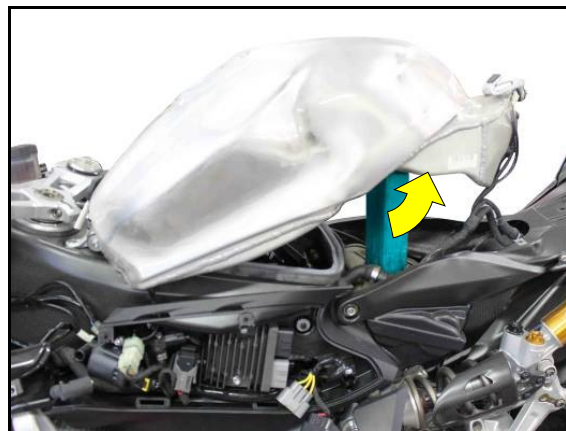
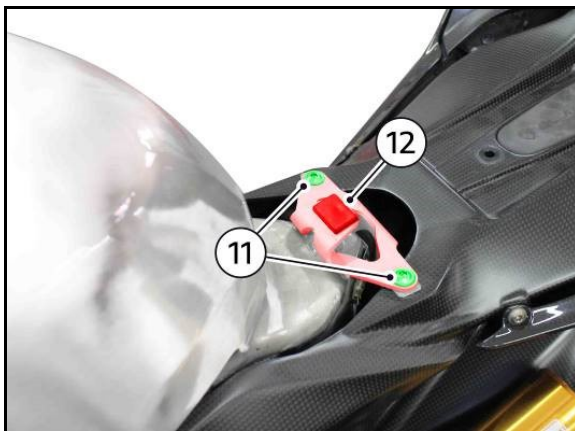



CR180 – Breather valve kit part no.69929001A installation

1199 Superleggera Model Year 2014

1299 Superleggera Model Year 2017

1299 Panigale R Final Edition Model Year 2018

Panigale R Model Year 2015-2017

Safety Recall Bulletin SRV-RCL-19-002

15. Disconnect fuel level sensor **connector (12)** and **ground cable (13)**

16. Release the BBS control unit from the rear subframe and disconnect **connector (14)**

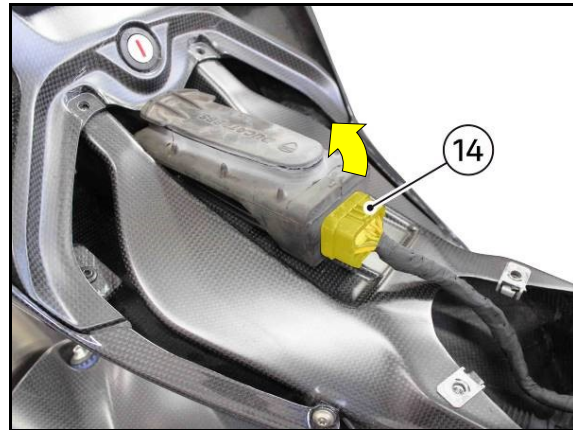
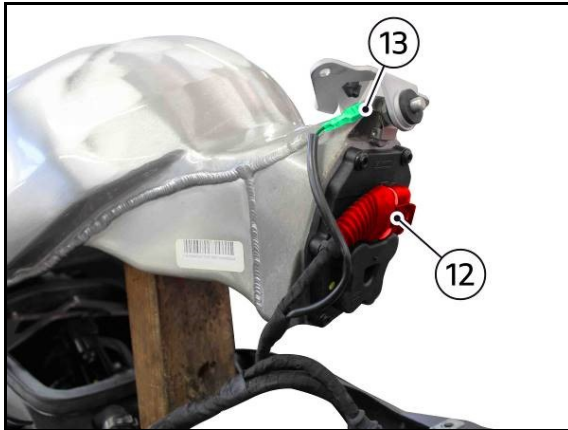

17. Disconnect the rear wiring **connector (15)**

18. Pull out the vertical head pressure sensor **hose (16)** by removing the **clamp (17)**

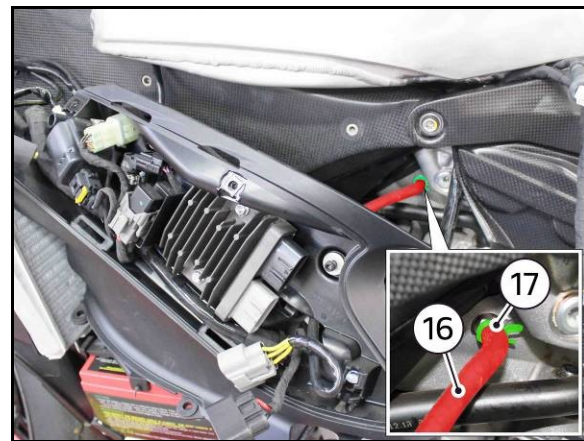
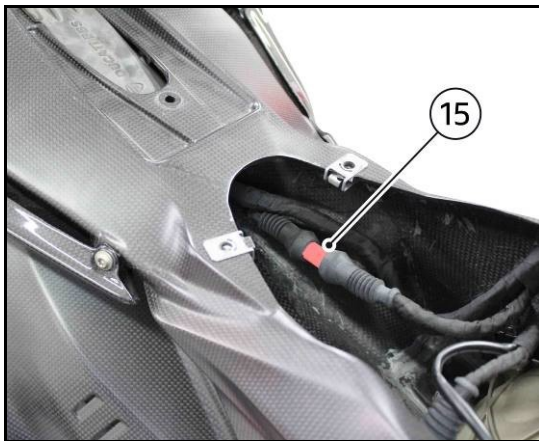



CR180 – Breather valve kit part no.69929001A installation

1199 Superleggera Model Year 2014

1299 Superleggera Model Year 2017

1299 Panigale R Final Edition Model Year 2018

Panigale R Model Year 2015-2017

Safety Recall Bulletin SRV-RCL-19-002

19. Disconnect vertical head pressure sensor connector (18)

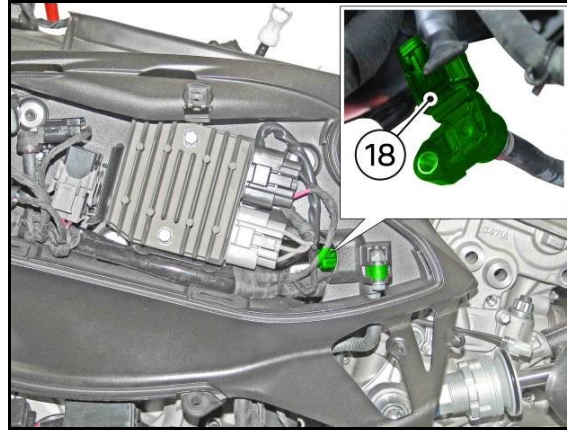

20. To access the cyclone hose (19), rotate the electrical components support towards the front side and fasten it with an elastic band, as shown in the figure

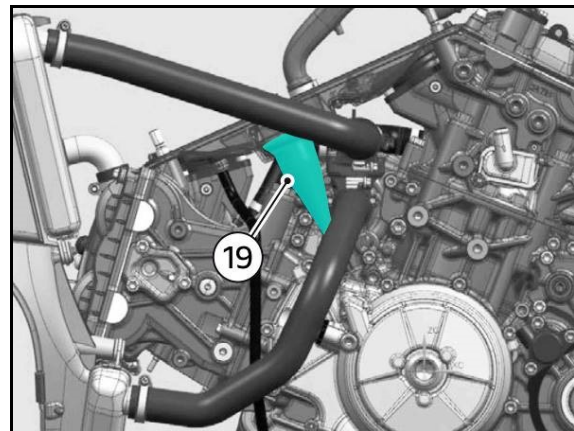
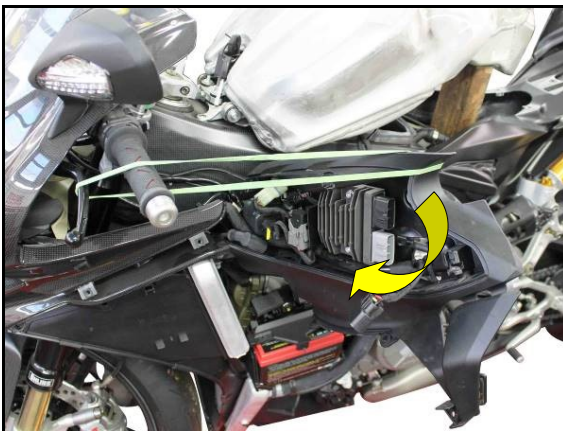

NOTE

If the adapter hose and junction were installed previously during the performance of SAT-901, remove and discard the additional hose section and junction.



CR180 – Breather valve kit part no.69929001A installation

1199 Superleggera Model Year 2014

1299 Superleggera Model Year 2017

1299 Panigale R Final Edition Model Year 2018

Panigale R Model Year 2015-2017

Safety Recall Bulletin SRV-RCL-19-002

21. To install the Breather valve kit part no.69929001A it is necessary to modify the cyclone **hose (19)** installed on the vehicle.

Use a marker to make a mark on the cyclone **hose (19)** at a length of **35 mm** measured from the Airbox bottom; use a cutter or workshop scissors to cut the hose in correspondence of the mark previously made with the marker.

22. Remove the click **clamp (20)** and pull out the lower part of the cyclone **hose (19)** from the crankcase

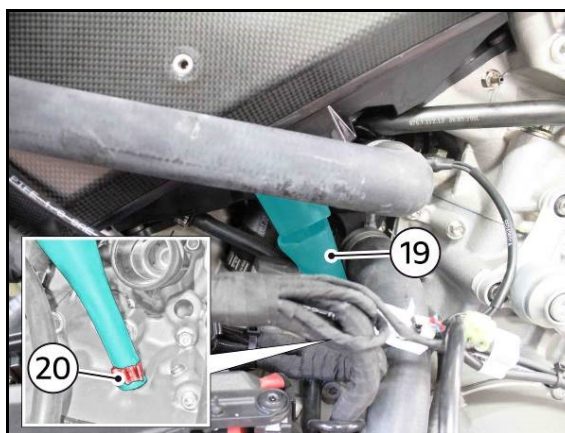
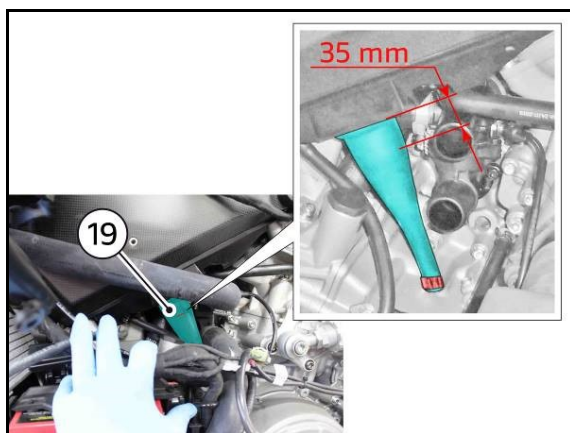

23. Take the tool part no.889450108, insert the buffer in the cyclone **hose (19)** driving it fully home and remove the excessive section of hose using a cutter.



ATTENTION

During the trimming operation, protect the surrounding components around the cyclone hose to avoid damaging the coolant hoses

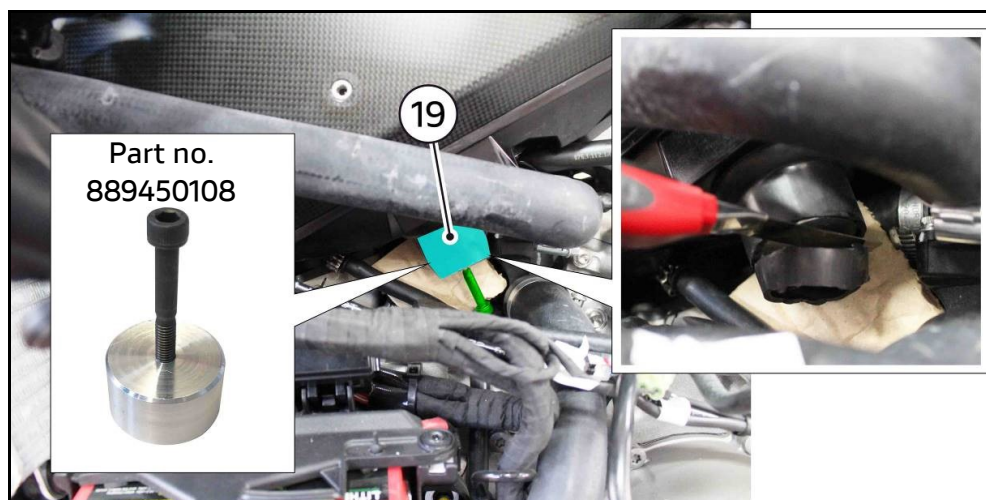



CR180 – Breather valve kit part no.69929001A installation

1199 Superleggera Model Year 2014

1299 Superleggera Model Year 2017

1299 Panigale R Final Edition Model Year 2018

Panigale R Model Year 2015-2017

Safety Recall Bulletin SRV-RCL-19-002



NOTE

Check that the remaining length of the cyclone **hose (19)** is equal to approx. 30 mm and remove both the protection used and the tool part no.889450108.



24. Take the kit part no.69929001A and assemble the **cyclone separator (A)**, the **click clamp (B)**, the **rubber hose (D)** and the **2 clamps (C)** as shown in the figure

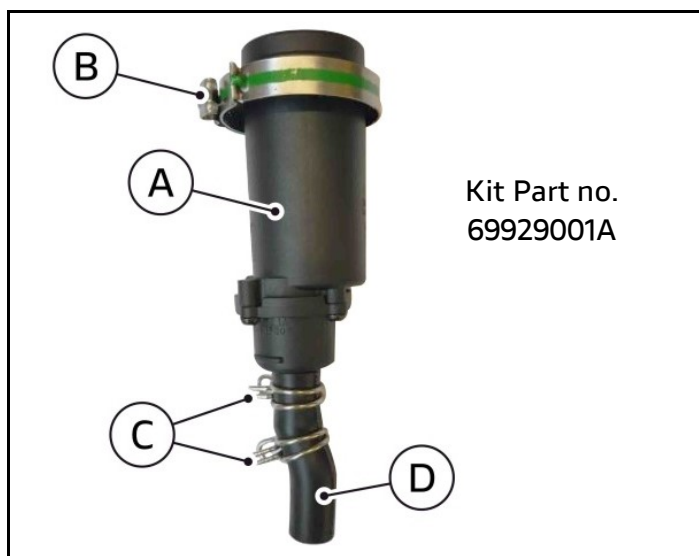



CR180 – Breather valve kit part no.69929001A installation

1199 Superleggera Model Year 2014

1299 Superleggera Model Year 2017

1299 Panigale R Final Edition Model Year 2018

Panigale R Model Year 2015-2017

Safety Recall Bulletin SRV-RCL-19-002

25. Install the **cyclone separator (A)** inside the cyclone hose aiming the stamping towards the vertical head, as shown in the figure. Fasten the cyclone separator using the **click clamp (B)**
26. Insert the terminal part of the **hose (D)** in the crankcase and aim the **2 clamps (C)** as shown in the figure

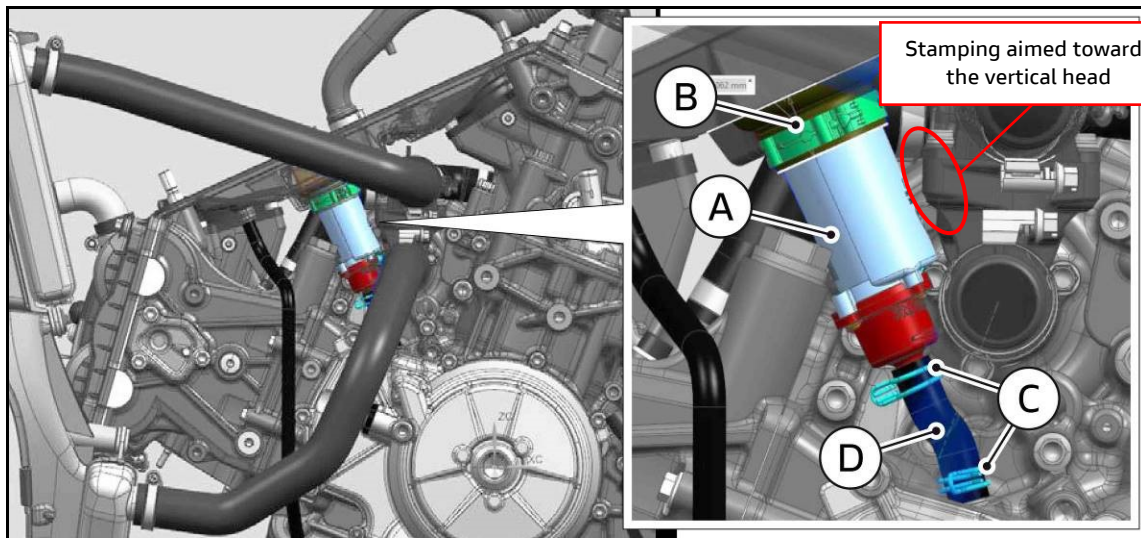

27. Remove the elastic band used to rotate the electrical components support
28. Connect the rear wiring **connector (15)**
29. Connect **connector (14)** and reposition the BBS control unit inside the rear subframe

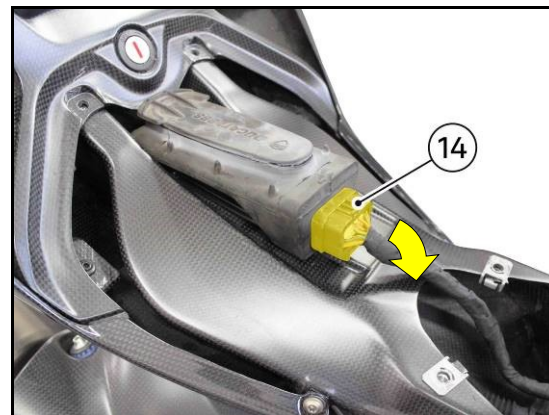
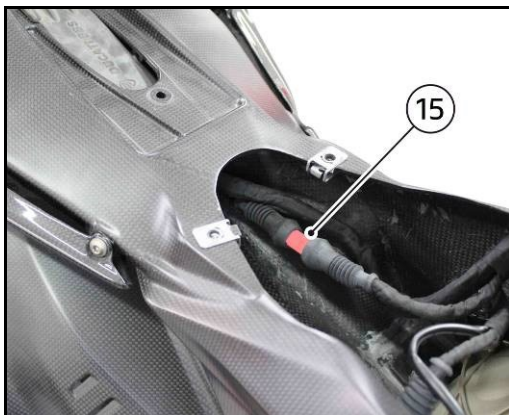



CR180 – Breather valve kit part no.69929001A installation

1199 Superleggera Model Year 2014

1299 Superleggera Model Year 2017

1299 Panigale R Final Edition Model Year 2018

Panigale R Model Year 2015-2017

Safety Recall Bulletin SRV-RCL-19-002

30. Connect fuel level sensor **connector (12)** and **ground cable (13)**

31. Remove the fuel tank support and fit **bracket (12)** tightening **2 M6x14 screws (11)** to **8 Nm \pm 10%**

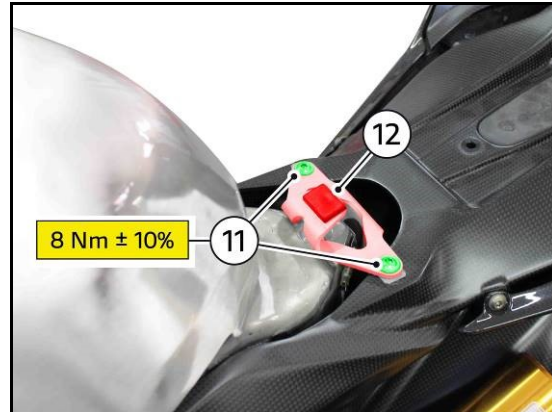
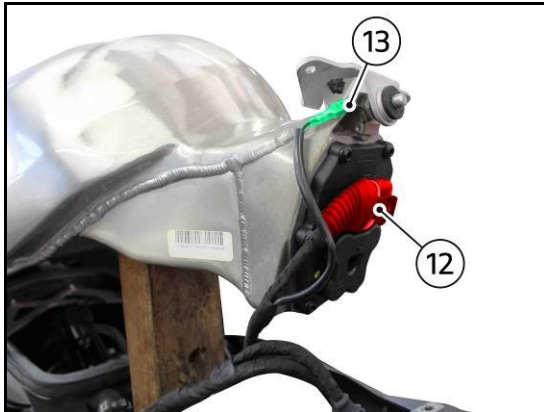

32. Connect vertical head pressure sensor **connector (18)**

33. Connect the vertical head pressure sensor **hose (16)** and fasten it with **clamp (17)** aiming it as shown in the figure

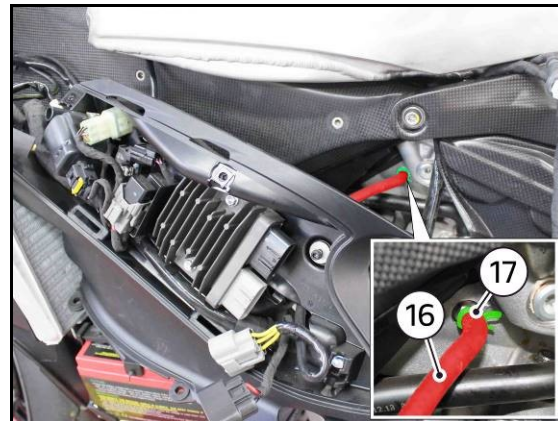
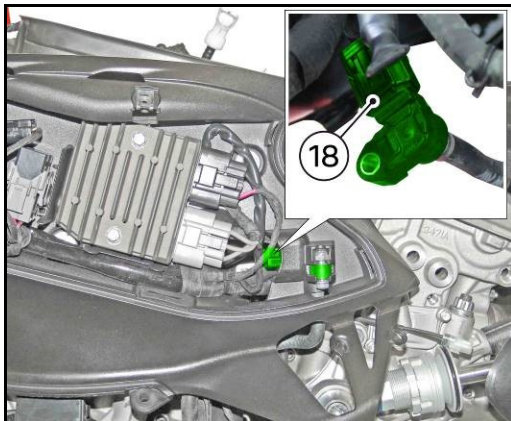



CR180 – Breather valve kit part no.69929001A installation

1199 Superleggera Model Year 2014

1299 Superleggera Model Year 2017

1299 Panigale R Final Edition Model Year 2018

Panigale R Model Year 2015-2017

Safety Recall Bulletin SRV-RCL-19-002

34. Fit the **2 connectors (10)** of the voltage regulator

35. Fasten the pressure sensor to the electrical components support by fitting **nut (9)** and tightening **M6x22 fastening screw (8)** to **4 Nm \pm 10%**

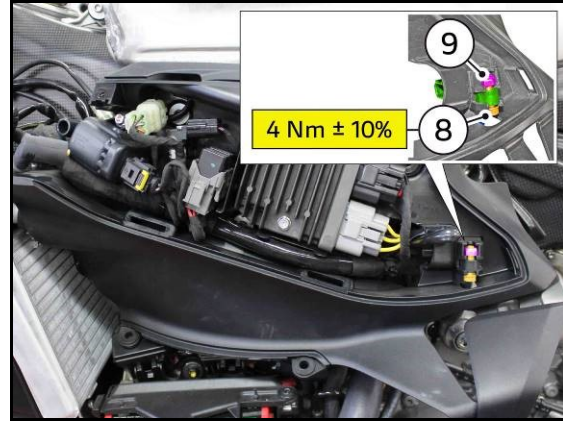
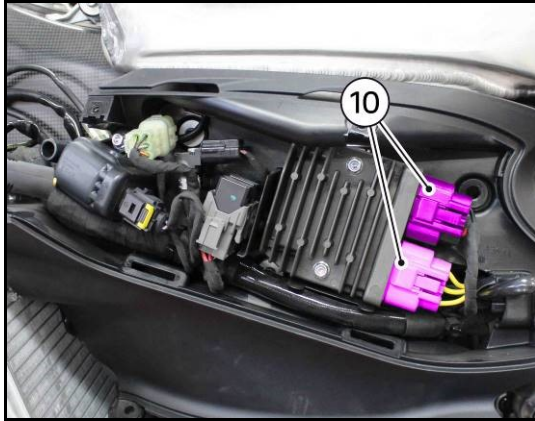

36. Connect the **spark plug cable (5)** of the horizontal cylinder coil

37. Connect ignition switch **connector (7)** and fasten it to the electrical components support using a new **self-locking tie (21)** and aim it as shown in the figure

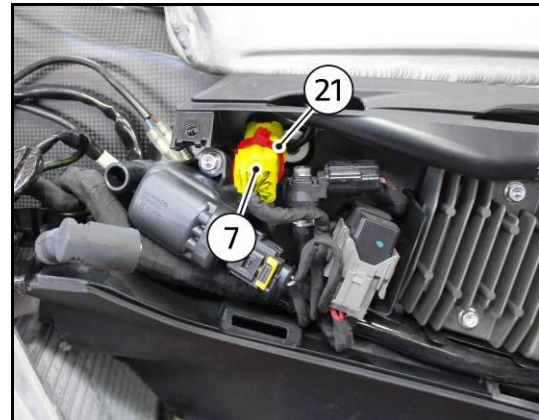
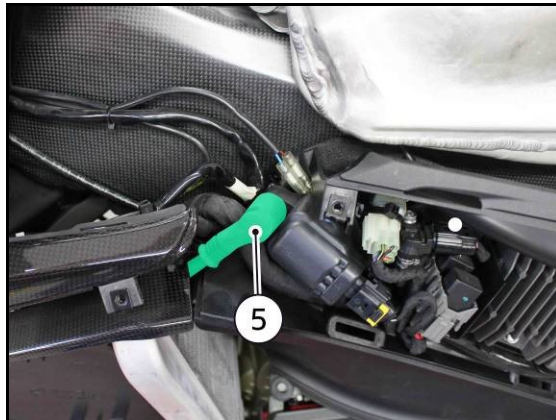



CR180 – Breather valve kit part no.69929001A installation

1199 Superleggera Model Year 2014

1299 Superleggera Model Year 2017

1299 Panigale R Final Edition Model Year 2018

Panigale R Model Year 2015-2017

Safety Recall Bulletin SRV-RCL-19-002

38. Install the electrical components support by starting the **3 M5x22 screws (2)** with the relevant **spacers (3)**. Tighten the **3 M5x22 screws (2)** to **5 Nm ± 10%**

39. Install the 2 new big self-locking **ties (22)** as shown in the figure

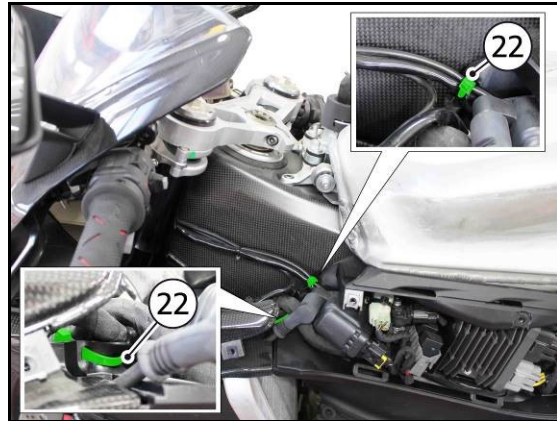
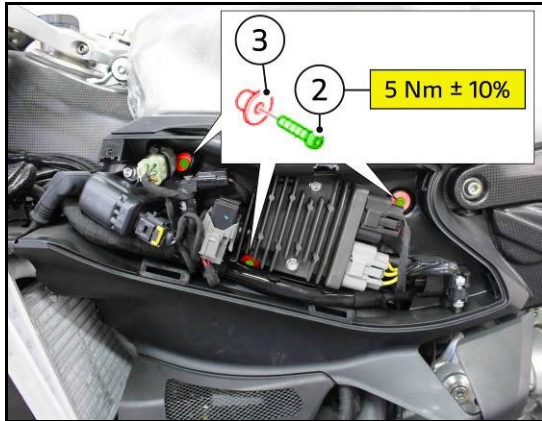

40. Install the battery **cover (1)** as shown in the figure

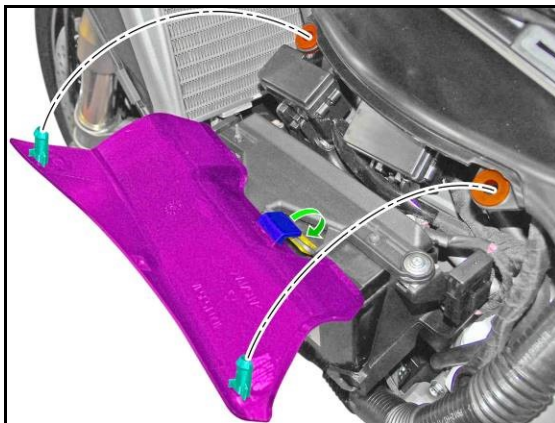



CR180 – Breather valve kit part no.69929001A installation

1199 Superleggera Model Year 2014

1299 Superleggera Model Year 2017

1299 Panigale R Final Edition Model Year 2018

Panigale R Model Year 2015-2017

Safety Recall Bulletin SRV-RCL-19-002

41. Fit the LH side fairing (see Sec. 5: "Fairing installation – Fairing" of the Workshop Manual)
42. Fit the ignition switch cover (see Sec. 5: "Fairing installation – Headlight Fairing" of the Workshop Manual)
43. Fit both right and left air conveyer covers (see Sec. 5: "Fairing installation – Headlight Fairing" of the Workshop Manual)
44. Fit the rider seat (see Sec.5: "Fairing installation – Seat" of the Workshop Manual)
45. Remove the rear paddock stand

For questions on this Safety Recall Campaign,
please contact your Service Area Manager.



CR180 – Breather valve kit part no.69929001A installation

1199 Superleggera Model Year 2014

1299 Superleggera Model Year 2017

1299 Panigale R Final Edition Model Year 2018

Panigale R Model Year 2015-2017

Safety Recall Bulletin SRV-RCL-19-002

Campaign Authorization

Ducati North America, Inc. will mail a notification letter to all known owners. If a customer does not present this notification letter, it is important that you confirm the eligibility for recall status on the DCS before you commence work. Reimbursement requests for duplicate recall campaign repairs will not be accepted.

Dealer Obligation

This program is designed to complete the necessary repairs and to achieve owner satisfaction. Therefore, we ask that you to take prompt and courteous action in accordance with these directives. Please provide a copy of this communication to every person in your dealership who has recall-related responsibilities. Please direct any questions or concerns to your Service Area Manager.

Thank you for your cooperation.

Service Department
Ducati North America, Inc.



CR180 – Breather valve kit part no.69929001A installation

1199 Superleggera Model Year 2014
1299 Superleggera Model Year 2017
1299 Panigale R Final Edition Model Year 2018
Panigale R Model Year 2015-2017
Safety Recall Bulletin SRV-RCL-19-002

IMPORTANT SAFETY RECALL NOTICE

This notice applies to your vehicle: XXXXXXXXXXXXXXXXXXXX

September 23, 2019

Customer Name
Customer Address
City, St, Zip Code

Subject:

Ducati Motorcycle: Panigale V4 (all models and country versions)

NHTSA Campaign I.D. Number: 19V-675

Transport Canada Safety Recall I.D. Number: 2019-XXX

Dealer Bulletin: SRV-RCL-19-002

Dear Ducati Owner,

This notice is sent to you in accordance with the U.S. National Traffic and Motor Vehicle Safety Act & Canada Motor Vehicle Safety Act. Ducati Motor Holding S.P.A. has decided that a defect which relates to motor vehicle safety exists in certain 2014-2018 Panigale 1199 and 1299 model motorcycles. Our records indicate that you are the owner of a Ducati motorcycle affected by this safety recall campaign. Please take the time to read this letter and help us take the appropriate steps to ensure that your vehicle is operating properly.

What is wrong?

Based on continued quality tests and service reports, it was identified that the engine vapor breather system could operate incorrectly, with possible consequent leakage of engine oil from the Airbox breather tube.

What will Ducati do?

An official Ducati dealer will update the crank case breather system with an updated valve and fluid separator assembly. The Dealer will perform this repair at no cost to you for parts and labor. We request that you contact your authorized Ducati dealer and schedule an appointment, so that the required repair can be performed without delay. The repair will take approximately 2.5 hours to complete. Service time will vary depending on dealer scheduling.



CR180 – Breather valve kit part no.69929001A installation

1199 Superleggera Model Year 2014

1299 Superleggera Model Year 2017

1299 Panigale R Final Edition Model Year 2018

Panigale R Model Year 2015-2017

Safety Recall Bulletin SRV-RCL-19-002

To locate your nearest authorized Ducati dealer, please go to www.ducati.com, and select the “dealer locator” or you may call toll free from the U.S. 1-888-391-5446.

Federal regulations require that any lessor receiving this recall notice must forward a copy of this notice to the lessee within ten days.

Service Problem Help:

If you believe that your dealer has failed or is unable to remedy the defect without charge, or within a reasonable period of time, please contact Ducati North America Customer Care at 1 (888) 391-5446.

If you still cannot obtain satisfaction, you may file a complaint with:

For USA Customers:

National Highway Traffic Safety Administration

1200 New Jersey Avenue, SE

Washington, D.C. 20590

Or call toll-free hotline at 1-888-327-4236 (TTY 1- 800-424-9153), or go to

[HTTP://WWW.SAFERCAR.GOV](http://WWW.SAFERCAR.GOV).

For Canadian customers:

Please contact Ducati customer service at 1-888-391-5446 or for additional information about the recall you

can contact Transport Canada at 1-800-333-0510.

TREAD ACT CUSTOMER REIMBURSEMENT PLAN

If you have paid for the repair described in the attached letter, and you would like to be considered for reimbursement, please contact your authorized Ducati dealer. Expenses from repair facilities outside of the authorized Ducati dealer network will be considered; however, the procedure must meet Ducati North America’s standards.

Your authorized Ducati retailer will request a copy of your owner notification letter, as well as, a copy of your previously paid invoice. They’ll inspect the vehicle, if still in your possession, prior to submitting a claim on your behalf to Ducati North America, Inc. for reimbursement.



CR180 – Breather valve kit part no.69929001A installation

1199 Superleggera Model Year 2014

1299 Superleggera Model Year 2017

1299 Panigale R Final Edition Model Year 2018

Panigale R Model Year 2015-2017

Safety Recall Bulletin SRV-RCL-19-002

Only a repair involving this safety recall campaign is reimbursable. Ducati North America, Inc will not reimburse consequential expenses such as towing, rental, accommodations, and damage repairs.

We recommend that your authorized Ducati dealer be your primary contact on this issue. We anticipate that your authorized Ducati dealer will be able to answer any questions that you may have regarding your qualifications for reimbursement of a previous repair; additionally, our Customer Relations Dept. may be contacted at 888-391-5446 for any special assistance required.

We regret any inconvenience to you from this action; however, your safety and satisfaction are important to us.

Sincerely,

Richard Kenton
Technical Director – Ducati North America