



SIB 12 30 19

2019-12-20

## RECALL 19V-883: TRANSMISSION WIRING HARNESS

Please perform the procedure outlined in this Service Information on all affected vehicles before customer delivery. In the event the customer has already taken delivery of the vehicle, please perform the procedure the next time the vehicle is in the shop.

This Service Information Bulletin (Revision 3) replaces SI B12 30 19 **dated December 2019**.

### What's New (Specific text highlighted):

- Recall number updated in the title
- Interim solution removed from Procedure
- Parts Information

## MODEL

E-Series	Model Descriptions	Production Dates	Engine
F90	M5 Sedan	January 30, 2019 – October 30, 2019	S63M
F91	M8 Convertible	February 20, 2019 – October 30, 2019	S63M
F92	M8 Coupe	July 3, 2019 – October 20, 2019	S63M
F93	M8 Gran Coupe	June 19, 2019 – October 29, 2019	S63M

## AFFECTED VEHICLES

Vehicles which require this Recall Campaign to be completed will show it as "Open" when checked either in AIR, the "Service Menu" of DCSnet (Dealer Communication System) or with ISPA NEXT. Recall letter and Q&A are attached.

## SITUATION

BMW of North America, LLC is conducting a Voluntary Safety Recall (effective December 5, 2019) on certain Model Year 2019-2020 BMW vehicles that were produced between January 30, 2019 and October 30, 2019.

The transmission wiring harness could become damaged due to the location and routing. This could lead to a short circuit, which affects the transmission function; and causes the vehicle to lose propulsion and to shift to Neutral while driving, increasing the risk of a crash.

The Recall Notice and Q&A have been attached for further information.

## CAUSE

The transmission wiring harness may be damaged due to high temperature, combined with compression from the wiring harness mounting clip. This damage may result in an electrical short circuit in the transmission wiring harness.

## CORRECTION

Check the vehicle mileage, then repair and/or relocate the transmission electrical harness as described in the required procedure.

Determine the current mileage displayed in the vehicle's instrument cluster:

If the vehicle mileage is under **six (6) miles and the vehicle has not been delivered** (no in-service date) to the customer:

- Perform the attached **Procedure A** (Reposition the transmission wiring harness)

All other vehicles:

- Perform the attached **Procedure B** (Rework the transmission wiring harness)

**Note for Procedure A and B:** The bolts for the transmission cross member can be reused, they do not need to be replaced as part of this bulletin's repair procedure.

Note: The **interim solution** is no longer a valid repair procedure because the cable strap with bracket (P/N 34 32 7 708 473) is now available. Vehicles which have been previously repaired with the **interim solution** do not require additional repairs.

## **PARTS INFORMATION**

**Note:** The bolts for the transmission cross member can be reused, they do not need to be replaced as part of this bulletin's repair procedure.

Only use and invoice the part numbers below.

Performing a part number look-up in ETK (EPC) by VIN or model in place of using/invoicing the following part numbers may result with the wrong part numbers being invoiced and installed, this could delay the payment of claim.

For **Procedure A** - Reposition the transmission wiring harness:

Part Number	Description	Quantity
34 32 7 708 473	Cable strap with bracket	2
61 13 6 902 588	Adhesive tape (orders round to a Qty of 25)	1 (if required)

Or:

For **Procedure B** - Rework the transmission wiring harness:

Part Number	Description	Quantity
34 32 7 708 473	Cable strap with bracket	2
61 13 1 379 833	Shrink hose (orders round to a Qty of 10)	2 (as needed)
61 13 8 353 748	Cable connector (orders round to a Qty of 10)	2 (as needed)
61 13 6 902 588	Adhesive tape (orders round to a Qty of 25)	1 (as needed)

## **WARRANTY INFORMATION**

Reimbursement for this Recall will be via normal claim entry utilizing the following information together with the part numbers the above that apply:

<b>Defect Code:</b>	<b>0012150500</b>
---------------------	-------------------

**Completion before the first vehicle delivery to a customer (no in-service date) and the vehicle mileage is under six (6) miles**

Work Pkg	Labor Operation	Description (Plus work)	Labor Allowance
# 1	00 68 828	<b>Procedure A</b> - Reposition the transmission wiring harness	6 FRU (F90/F91/F92); 7 FRU (F93)

Or:

**Completion before the first vehicle delivery to a customer (no in-service date) and the vehicle mileage is six (6) miles and higher but less than 300 miles or it is a delivered vehicle that is already**

**in the workshop**

Work Pkg	Labor Operation	Description (Plus work)	Labor Allowance
# 2	00 68 834	<b>Procedure B</b> - Rework the transmission wiring harness	7 FRU (F90/F91/F92) 8 FRU (F93)

Or:

**The vehicle arrives at your center and this Recall Campaign shows open (No other Main work will be performed/claimed during this workshop visit)**

Work Pkg	Labor Operation	Description (Main work)	Labor Allowance
# 3	00 68 248	<b>Procedure B</b> - Rework the transmission wiring harness	9 FRU (F90/F91/F92/F93)

And, with the above as necessary:

**Associated work with WP 1, 2 or 3**

Labor Operation	Description (Plus work)	Labor Allowance
00 68 835	Reworking the ground line	1 FRU

**Claim Repair Comments**

Only reference the SIB number and the work package (Pkg) number performed in the RO technician notes and in the claim comments (For example: B12 30 19 WP 1), unless otherwise required by State law.

**Supporting Materials**

[picture\\_as\\_pdf B123019 2019-2020-F9x-TransmissionWiringHarness-QA\(19Dec2019\).pdf](#)

[picture\\_as\\_pdf B123019 Recall Notice.pdf](#)

[picture\\_as\\_pdf B123019 Procedure A.pdf](#)

[picture\\_as\\_pdf B123019 Procedure B.pdf](#)

## **SAFETY RECALL NOTICE**

To: All Center Operators, Sales Managers, Service Manager, Parts Manager and Warranty Processor

RE: Recall 19V-883: Transmission Wiring Harness – B12 30 19

BMW of North America, LLC is conducting a Voluntary Safety Recall (effective December 5, 2019) on a certain Model Year 2019-2020 BMW vehicles that were produced between January 30, 2019 and November 27, 2019.

**Please be reminded that it is a violation of federal law (The Safety Act) for you to sell, lease or deliver any new motor vehicle covered by this notification until the recall repair has been performed. This means that centers may not legally deliver new motor vehicles to consumers until they are fixed or use/sell replacement equipment/parts subject to this recall. Note also that substantial civil penalties apply to violations of the Safety Act.**

**Also, you should not sell, lease or deliver any Certified Pre-Owned or used vehicles subject to a safety recall until the repair is completed.**

**Please follow any special instructions that we provide to you for the return or disposition of recall parts.**

We appreciate all your assistance with this Recall.

## RECALL 19V-883: TRANSMISSION WIRING HARNESS

### PROCEDURE A - Reposition the transmission wiring harness

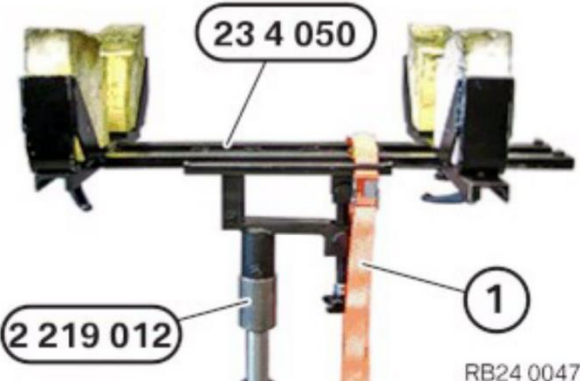
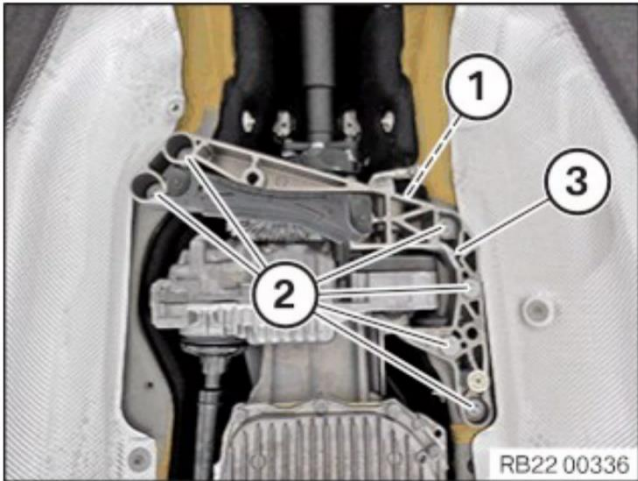
 <p>RB61 04141</p>	<p>Risk of short circuits! Risk of fire!</p> <p>Make sure that there is no charger connected to the jump start terminal in the engine compartment.</p> <ol style="list-style-type: none"> <li>1. Disconnect all negative battery cables.</li> </ol>
 <p>23 4 050</p> <p>2 219 012</p> <p>1</p> <p>RB24 00477</p>	<ol style="list-style-type: none"> <li>2. Remove the transmission crossmember by supporting the transmission with special tools 0 495 498 (23 4 050) and 2 219 012.</li> </ol> <p>Secure the transmission with lashing straps (1).</p>
 <p>1</p> <p>2</p> <p>3</p> <p>RB22 00336</p>	<ol style="list-style-type: none"> <li>3. Release and remove screw (1).</li> <li>4. Release screws (2).</li> <li>5. Remove transmission crossmember (3).</li> </ol>



6. Disconnect the transfer case and transmission 12 V connectors.

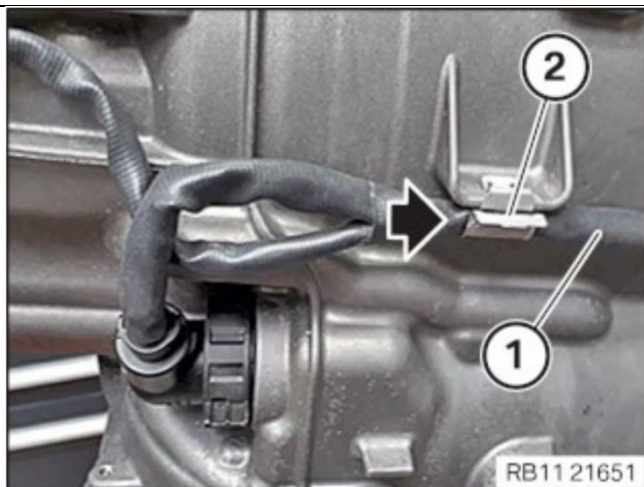

7. Remove the transmission wiring harness (1) from the retaining bracket (2).

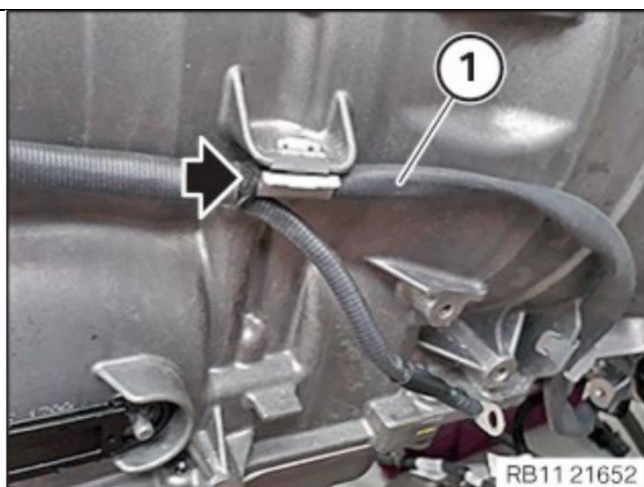

8. Remove the transmission wiring harness (1).

9. Remove transmission harness grounding lug.



10. Position the tape measure on the connector housing.

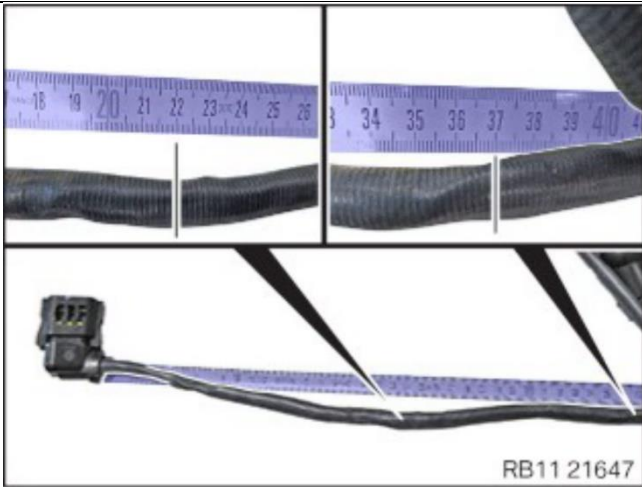

11. Measure the transmission wiring harness with a tape measure from the transfer case connector housing shown in step 6.

12. Cut two pieces of tape approximately 4 inches long.

Part Number: 61 13 6 902 588

13. Wrap one piece of tape around the harness at approximately 8 5/8 inches.

Wrap the other piece of tape around the harness at approximately 14 1/2 inches.

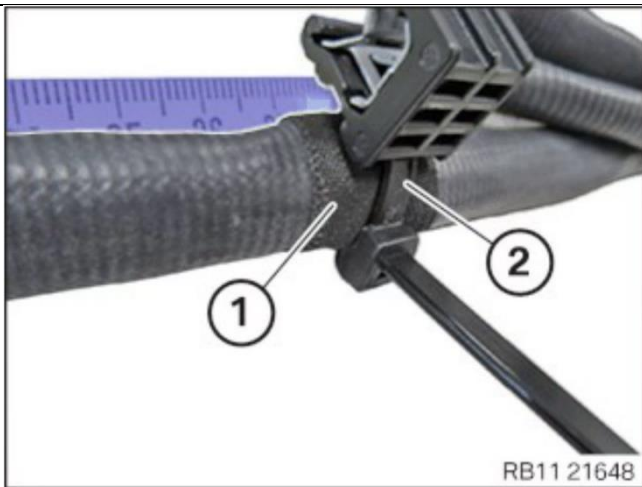

14. Loosely position the clip with a cable strap (2) on the fabric adhesive tape (1) at approximately 8 5/8".

15. Loosely position the clip with a cable strap at approximately 14 1/2 inches position.

Part Number: 34 32 7 708 473

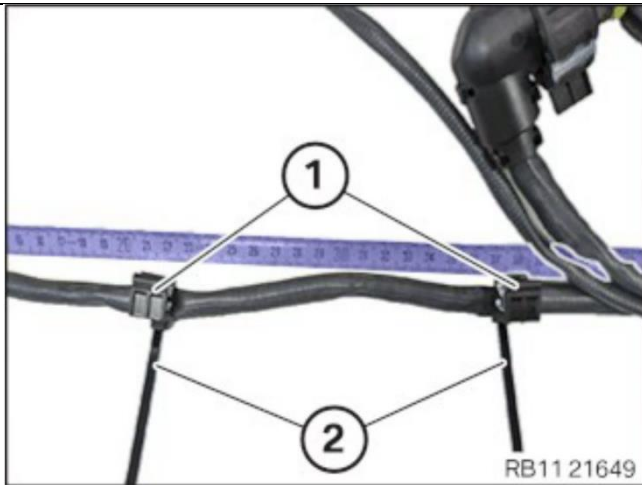

16. Secure the clips with the openings facing upwards (see graphic).

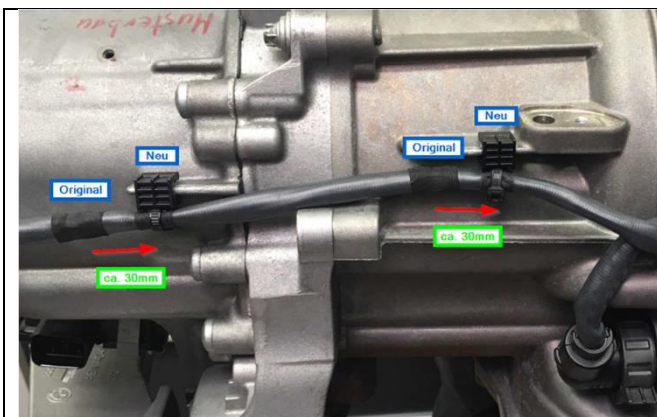

The cable strap location must be moved approximately 1 3/16 inches toward the front of the vehicle.

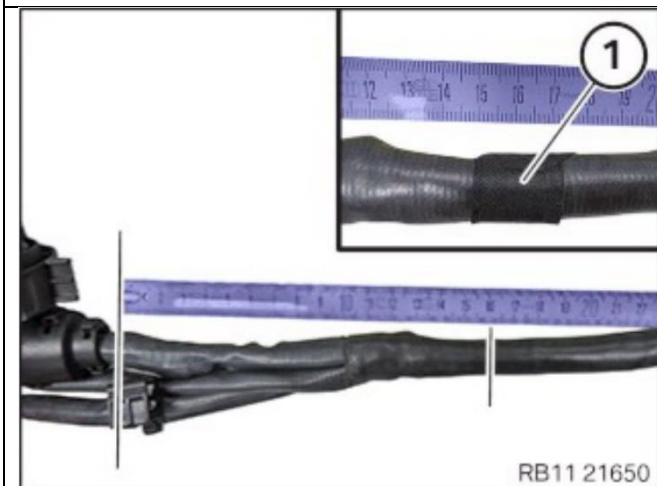

17. Cut a piece of tape approximately 4 inches long.

18. Attach the fabric adhesive tape (1) to the transmission wiring harness at approximately 6 1/4 inches from the transmission connector housing.

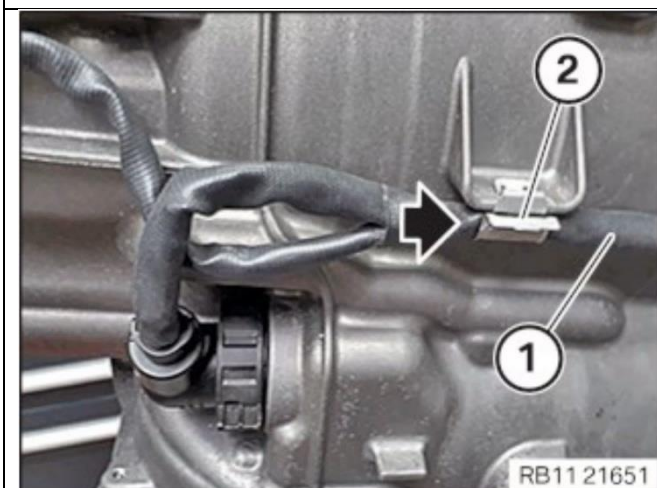

19. Insert transmission wiring harness (1) to transmission retaining bracket (2) at the transmission tape position.



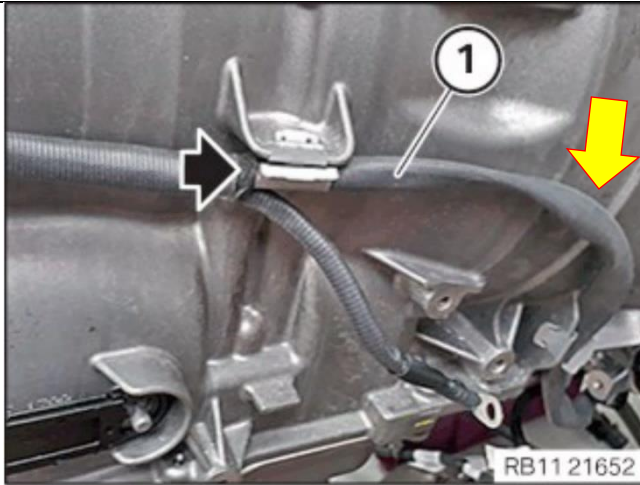

20. Insert the transmission wiring harness (1; see graphic).

21. Secure transmission grounding.

Ground connection on the transmission  
Screw M6 x 12: Tightening torque 10 Nm.

Note: Ensure enough slack (right arrow) so the harness is not pulled taught over the transmission housing casting lines.

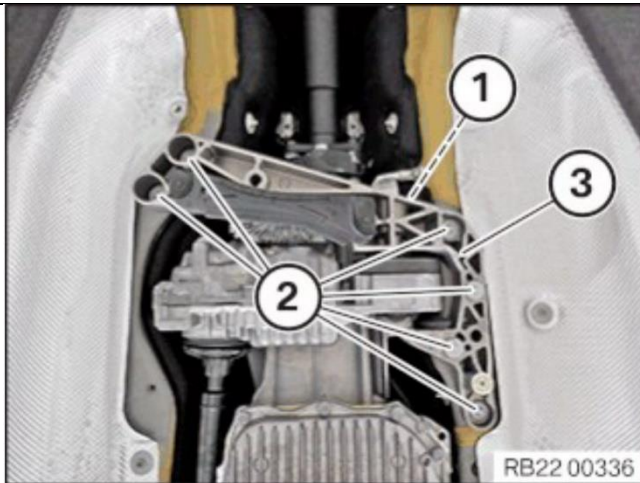

22. Install the gearbox crossmember (3).

23. Tighten screw (1).

Transmission crossmember on rubber mount  
M12: Tightening torque 68 Nm.

24. Tighten screws (2).

Transmission crossmember on the body M8:  
Tightening torque 19 Nm.

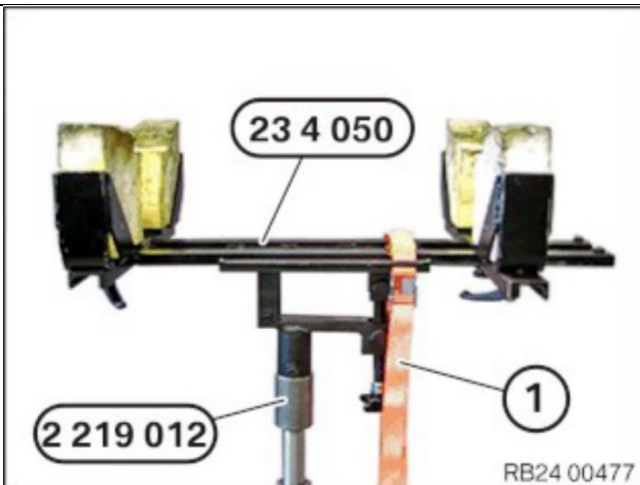

25. Release the lashing strap (1) from the transmission.

26. Remove special tools 0 495 498 (23 4 050) and 2 219 012



RB61 04141

27. Connect all negative battery cables.

Negative battery terminal Nut: tightening torque 5Nm.

## RECALL 19V-883: TRANSMISSION WIRING HARNESS

### PROCEDURE B - Rework the transmission wiring harness

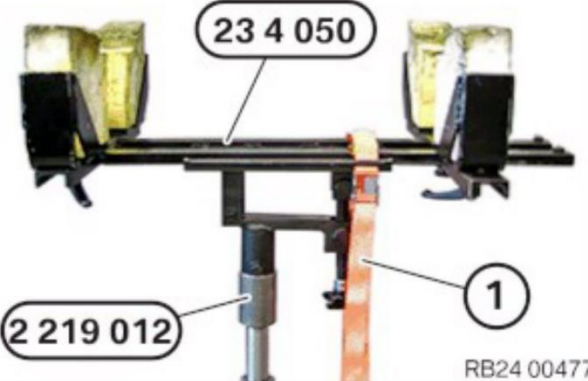
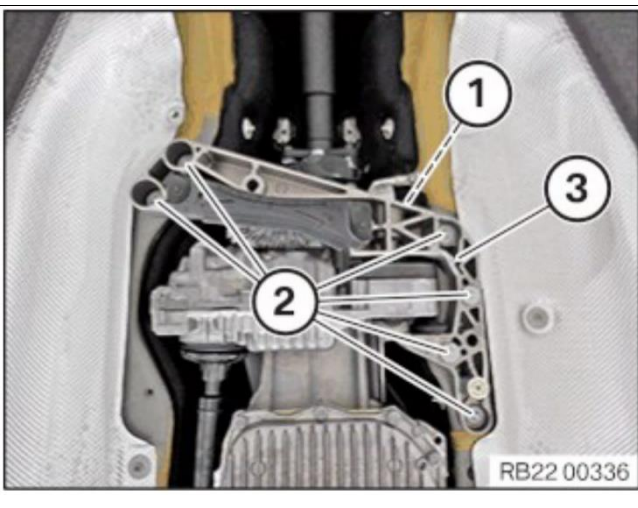
	<p>Risk of short circuits! Risk of fire!</p> <p>Make sure that there is no charger connected to the jump start terminal in the engine compartment.</p> <ol style="list-style-type: none"> <li>1. Disconnect all negative battery cables.</li> </ol>
	<ol style="list-style-type: none"> <li>2. Remove the transmission crossmember by supporting the transmission with special tools 0 495 498 (23 4 050) and 2 219 012.</li> </ol> <p>Secure the transmission with lashing straps (1).</p>
	<ol style="list-style-type: none"> <li>3. Release and remove screw (1).</li> <li>4. Release and remove screws (2).</li> <li>5. Remove transmission crossmember (3).</li> </ol>



6. Disconnect the 12 V connectors from the transfer case and transmission.



Branch (1) automatic transmission

Branch (2) transfer box

Branch (3) Not used in US vehicles

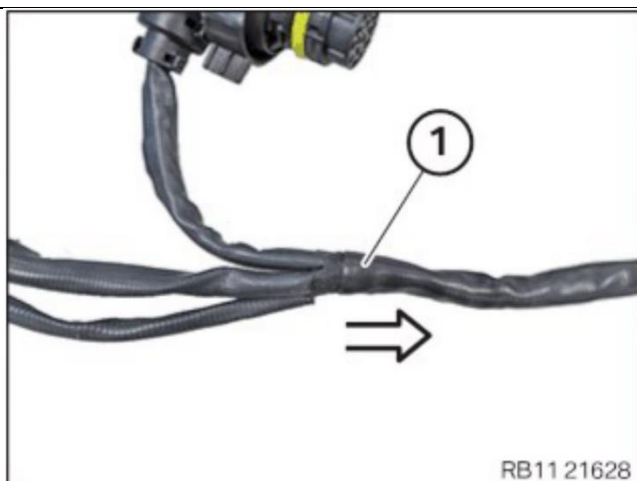

7. Push insulating sleeve (1) back in direction of the arrow 100 mm (approximately 4 inches).

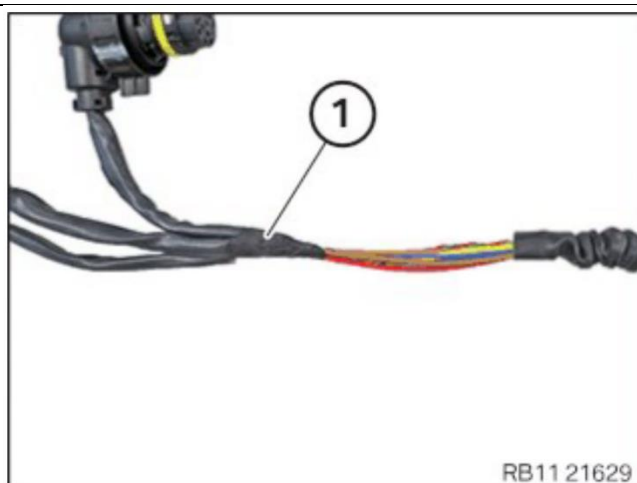

8. Open and remove insulating tape (1).



9. Open cable straps (1).

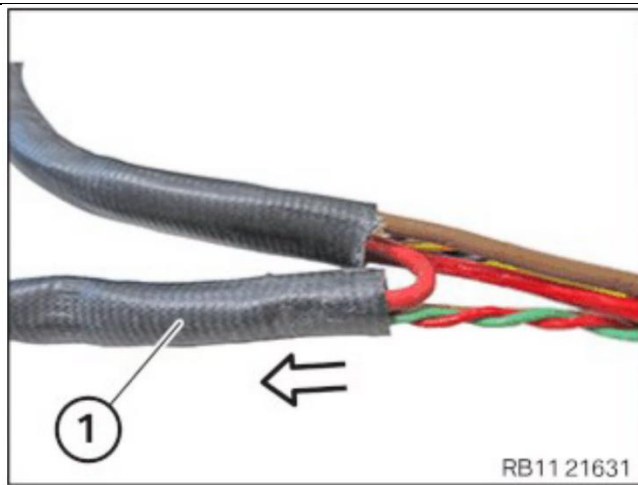

10. Push insulating sleeve (1) back in direction of the arrow 110 mm (approximately 4 ½ inches).

11. Check cable for damage.

Important: Steps 12 thru 20 must be performed even if damage is not observed.



12. Position the tape measure on the connector housing.

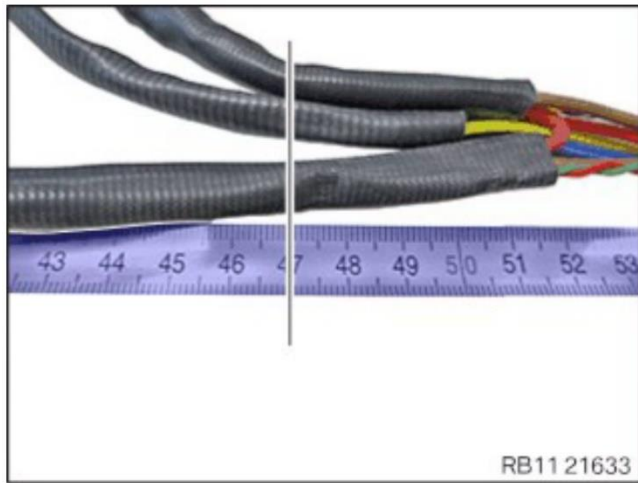

RB11 21633

13. Measure 470 mm (approximately 18 ½ inches) from the transfer case connector housing shown in step 12.

14. Mark the positive wire in the transmission wiring harness.

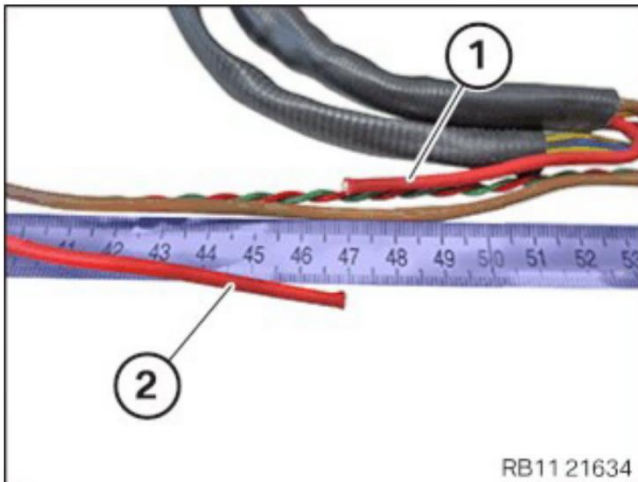

RB11 21634

15. Cut red positive wire at 470 mm (approximately 18 ½ inches) from the transfer case connector housing.

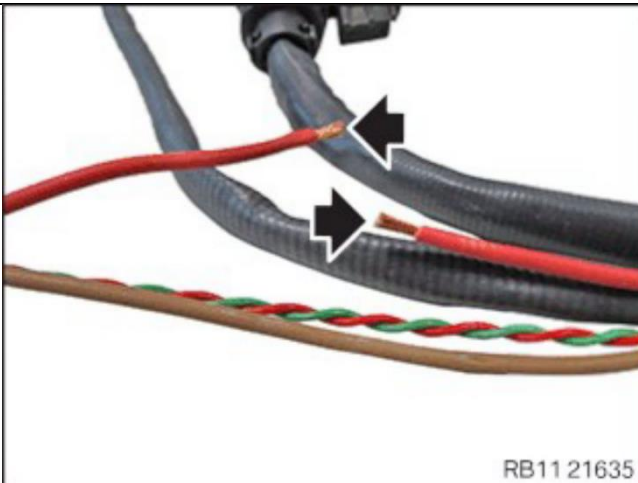

RB11 21635

16. Strip insulation from the ends of the positive wire.

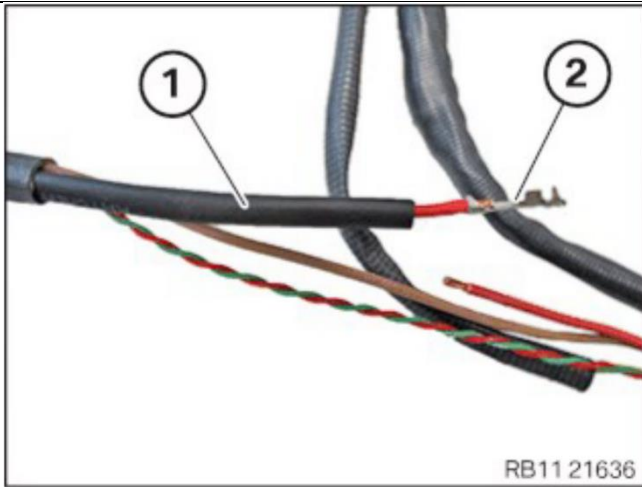

17. Push the insulating sleeve (1) onto the positive wire.

18. Crimp the positive wire with butt connector (2).

Part Number 61 13 8 353 748

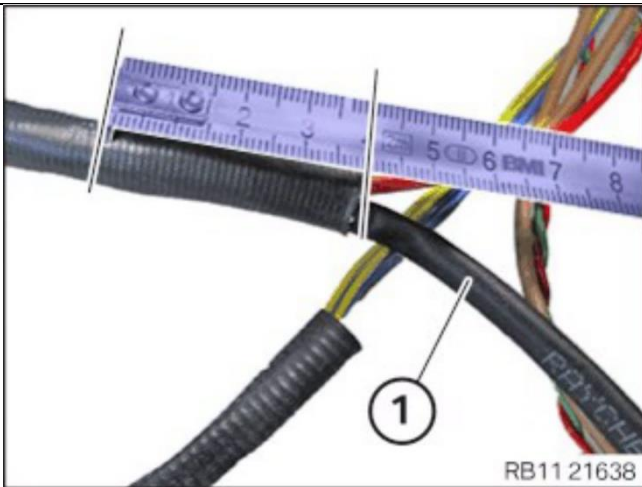

19. Insert the insulating sleeve (1) 40 mm (approximately 1 1/2 inches) under the heat protection shield.

Part Number 61 13 1 379 833

20. Heat the heat-shrink tubing (1) with a hot air blower with maximum 150°C (approximately 302°F) until the positive wire is insulated.

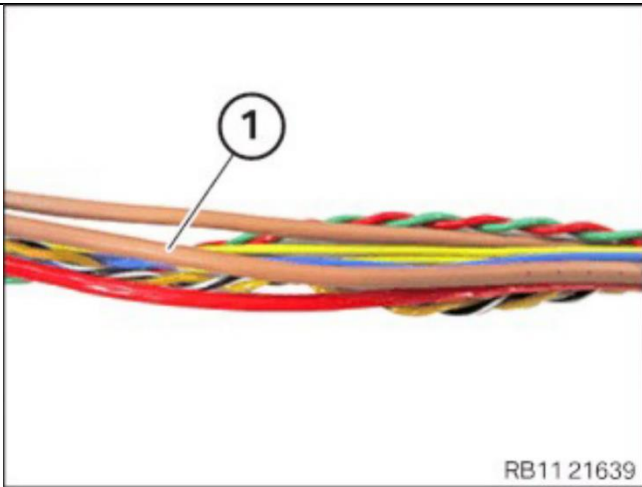

21. Check grounding cables (1) for damage and, if necessary, repair with an insulating sleeve.

Note: Do not perform steps 22 thru 27 if damage is not observed.

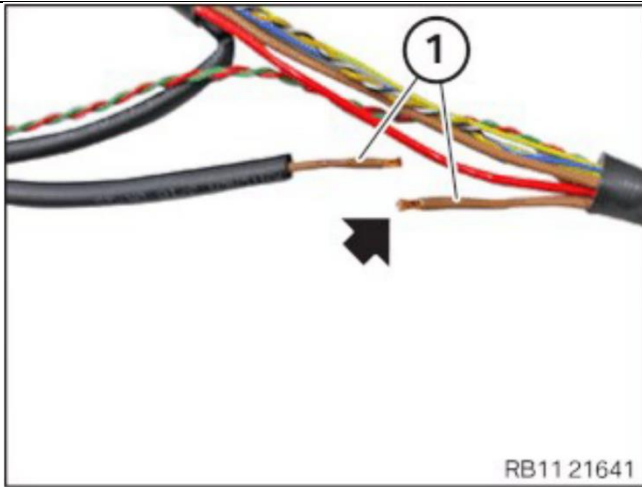

22. Strip insulation from ground cable (1) at both ends.
23. Push insulating sleeve onto ground cable.

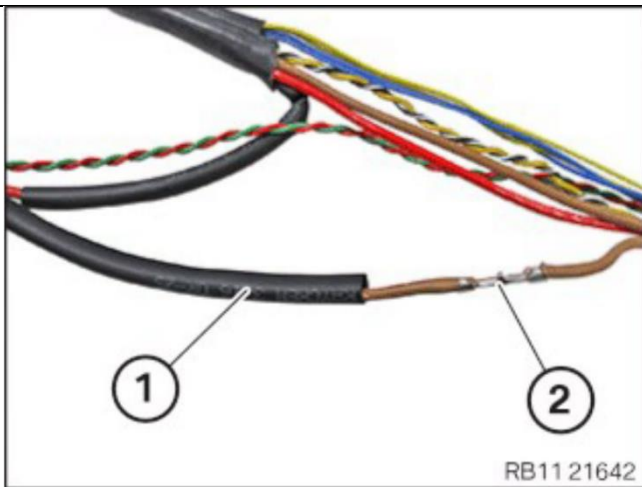

24. Crimp grounding cable with butt connector (2).
- Part Number 61 13 8 353 748
25. Slide the insulating sleeve (1) over the grounding cable.
- Part Number 61 13 1 379 833

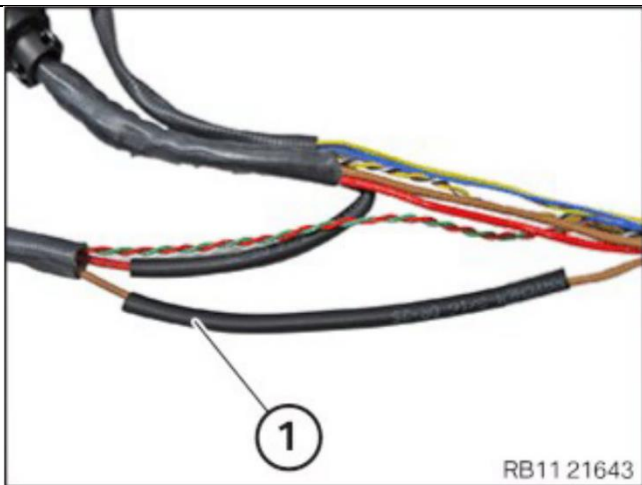

26. Slide the insulating sleeve (1) over the grounding cable.
27. Heat the heat-shrink tubing (1) with a hot air blower with maximum 150°C (approximately 302°F) until the grounding cable is insulated.



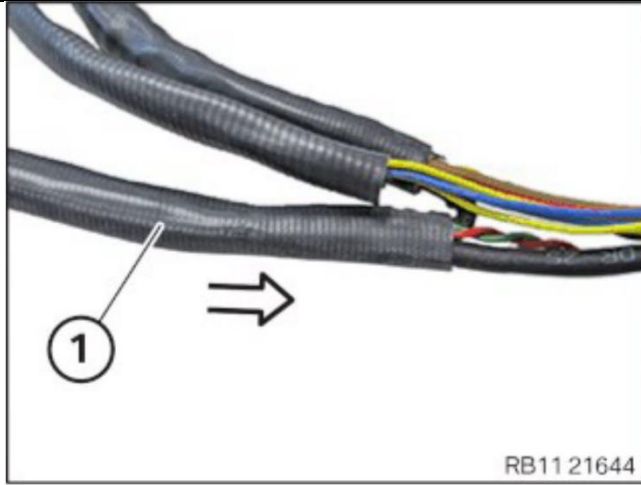

28. Push insulating sleeve (1) back into the end position in the direction of the arrow.

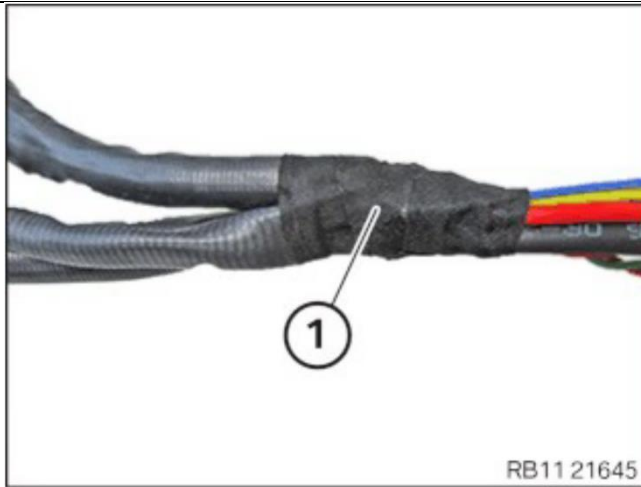

29. Secure and cover all insulating sleeves with fabric adhesive tape (1).

Part Number: 61 13 6 902 588

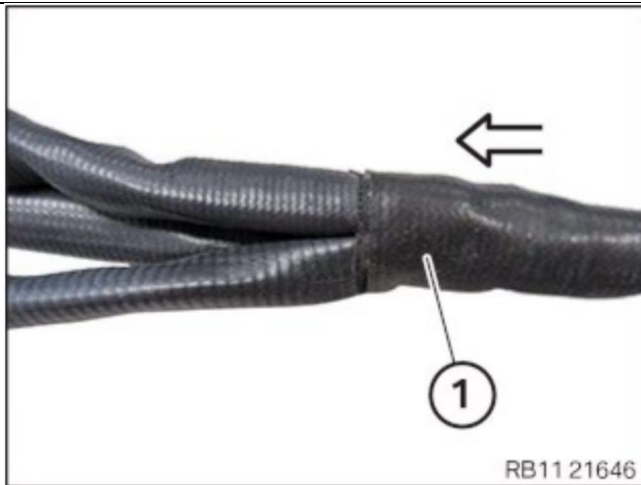

30. Put insulating sleeve (1) over the fabric adhesive tape in the direction of the arrow.

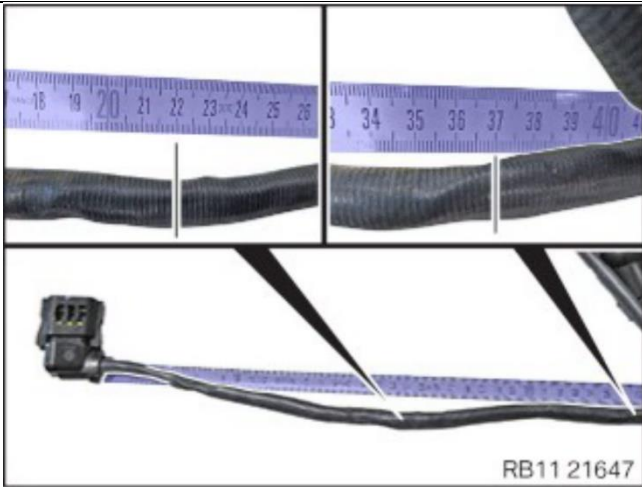

31. Measure the transmission wiring harness with a tape measure from the transfer case connector housing shown in step 12.

32. Cut two pieces of tape 100 mm (approximately 4 inches) long.

Part Number: 61 13 6 902 588

33. Wrap one piece of tap around the harness at 220 mm (approximately 8 5/8 inches).

34. Wrap the other piece of tape around the harness at 370 mm (approximately 14 1/2 inches).

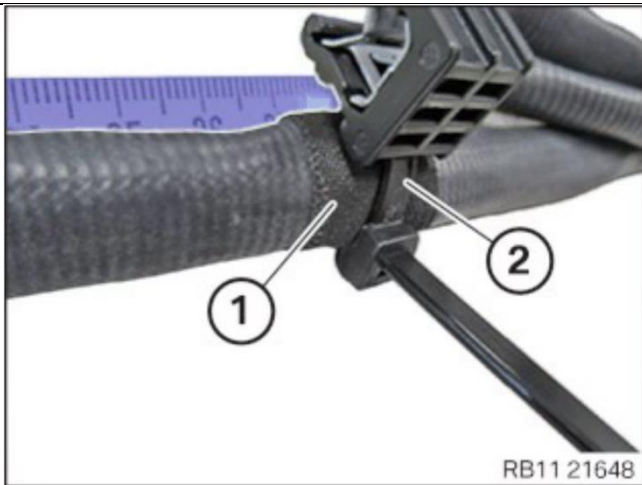

35. Loosely position the clip with a cable strap (2) on the fabric adhesive tape (1) at the 220 mm (approximately 8 5/8).

36. Loosely position the clip with a cable strap 370 mm (approximately 14 1/2 inches) position.

Part Number: 34 32 7 708 473

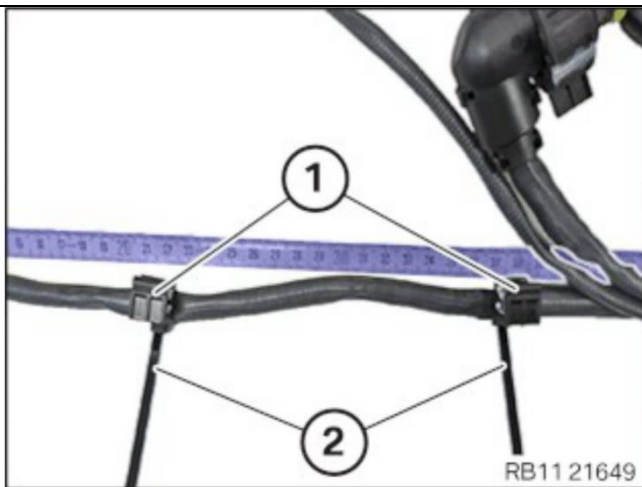

37. Secure the clips with the openings facing upwards (see graphic).

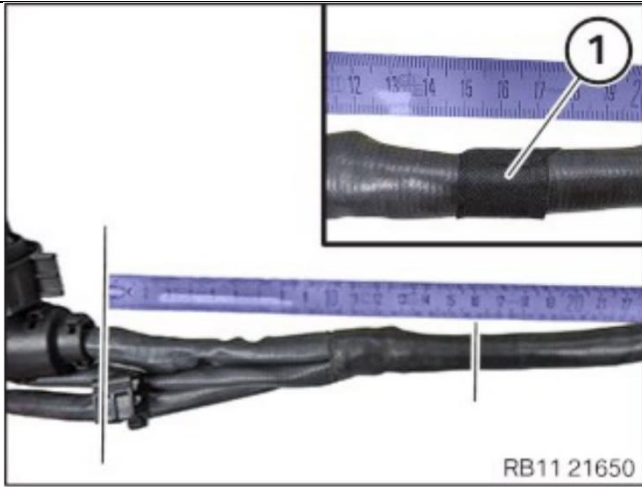

38. Attach the fabric adhesive tape (1) to the transmission wiring harness at 160 mm (approximately 6 ¼ inches) from the transmission connector housing.

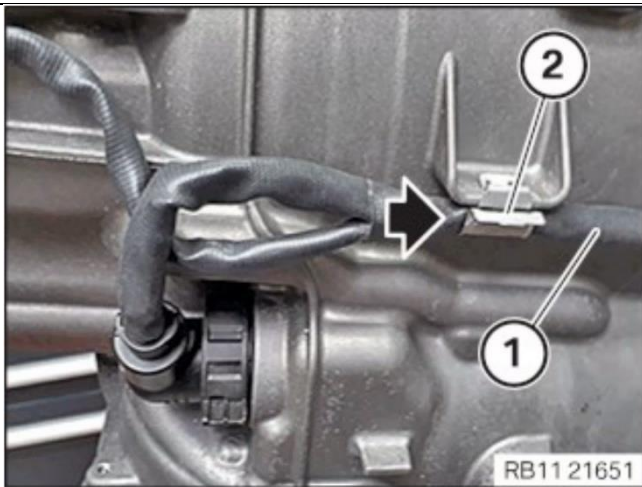

39. Insert the transmission wiring harness (1) to transmission retaining bracket (2) at the transmission tape position.

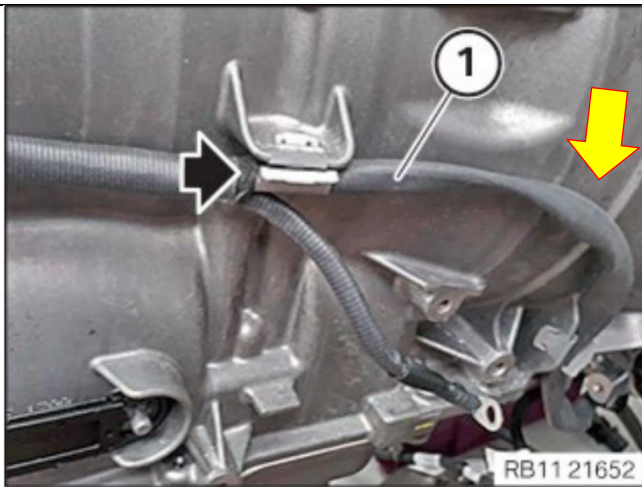

40. Insert the transmission wiring harness (1).

41. Secure transmission ground lug. Ground connection on the transmission Screw M6 x 12: Tightening torque 10 Nm.

Note: Ensure enough slack (right arrow) so the harness is not pulled taught over the transmission housing casting lines.

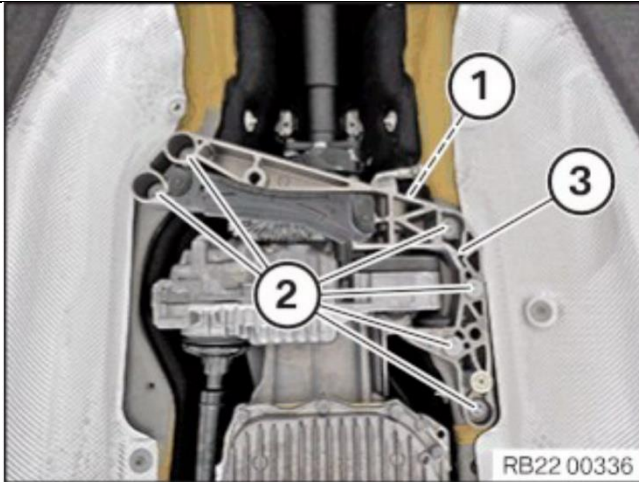

42. Install the gearbox crossmember (3).

43. Tighten screw (1).

Transmission crossmember on rubber mount M12: Tightening torque 68 Nm.

44. Tighten screws (2).

Transmission crossmember on the body M8: Tightening torque 19 Nm.

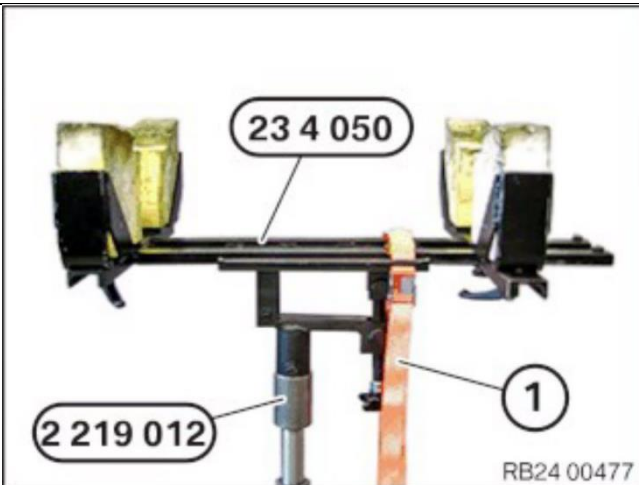

45. Release the lashing strap (1) from the transmission.

46. Remove special tools 0 495 498 (23 4 050) and 2 219 012.



47. Connect all negative battery cables.

Negative battery terminal nut: Tightening torque 5Nm.

**Transmission Wiring Harness  
Safety Recall 19V-883  
Model Year 2019-2020 BMW  
M5, M8  
*Last Updated 12/19/2019***

**Q1. Which BMW Group models in the US are potentially affected by this Safety Recall?**

Certain Model Year 2019-2020 BMW M5 and M8 vehicles produced between January and October 2019, are potentially affected. Please refer to the table below for further details.

<b>E-Series</b>	<b>Model Description</b>	<b>Production Date</b>
F90	M5 Sedan	January 30, 2019 – October 30, 2019
F91	M8 Convertible	February 20, 2019 – October 30, 2019
F92	M8 Coupe	July 3, 2019 – October 20, 2019
F93	M8 Gran Coupe	June 19, 2019 – October 29, 2019

**Q2. What is the specific issue?**

Due to the location and routing of the transmission wiring harness, it could become damaged. This could lead to a short circuit, affecting transmission function, cause the vehicle to lose propulsion and to shift to Neutral while driving, increasing the risk of a crash.

**Q3. Why are other BMW Group vehicles not included in this Safety Recall?**

Transmission wiring harness location and routing are specific to certain transmissions.

**Q4. How did BMW Group become aware of this issue?**

BMW Group became aware of this issue through its quality control procedures.

**Q5. Can I determine if this issue exists in my vehicle?**

If you notice that while driving the vehicle loses propulsion and the transmission shifts to Neutral, your vehicle may be experiencing this issue.

**Q6. What should I do if I notice this condition in my vehicle?**

If this condition occurs, please contact your authorized BMW center immediately to have this Safety Recall performed.

**Q7. Can I continue to drive my vehicle (before I receive my letter)?**

Yes. However, when you receive a letter requesting you to make an appointment to have this Safety Recall performed by an authorized BMW center, please do so as soon as possible. If you are not the only driver of this vehicle, please advise all other drivers of this important information.

**Q8. How will my vehicle be repaired?**

The transmission wiring harness will be inspected and rerouted or, in some cases, replaced and rerouted, for free and can take approximately one hour.

**Q9. Is BMW Group aware of any accidents or injuries in the US, involving these BMW Group vehicles associated with this Safety Recall?**

No.

**Q10. How will I be informed of this Safety Recall?**

You will receive a letter in February via First Class mail advising you of this Safety Recall and to schedule an appointment with an authorized BMW center to have this Safety Recall performed. You can locate your nearest authorized BMW center at [www.bmwusa.com/dealer](http://www.bmwusa.com/dealer). To ensure the BMW Group has your most recent contact and vehicle information, please register your BMW vehicle at [www.bmwusa.com/myBMW](http://www.bmwusa.com/myBMW). Registration is free, and will give you access to factory initiated campaigns and other information specific to your vehicle.

**Transmission Wiring Harness  
Safety Recall 19V-xyz  
Model Year 2019-2020  
BMW M5, M8  
*Last Updated 12/11/2019***

**Q11. Do I have to wait for my letter to have my vehicle serviced?**

Yes. BMW is in the process of ensuring that the necessary tools, parts, and procedures are available prior to contacting you to schedule an appointment with your authorized BMW center to have this important Safety Recall performed. For the latest updates to this Safety Recall, please visit [www.bmwusa.com/recall](http://www.bmwusa.com/recall).