



## SIB 52 24 19

2020-04-29

### RECALL 19V-823: ISOFIX CHILD SEAT ANCHORS

Please perform the procedure outlined in this Service Information on all affected vehicles before customer delivery. In the event the customer has already taken delivery of the vehicle, please perform the procedure the next time the vehicle is in the shop.

This Service Information Bulletin (Revision 4) replaces SI B52 24 19 **dated April 2020**.

#### What's New (Specific text highlighted):

- Parts Section updated – Refer to Parts Matrix for ordering procedure
- Attachment "B522419 ISOFIX-19V-823-QA-(27Apr2020)" revised

## MODEL

E-Series	Model Description	Production Date
F16	X6 Sports Activity Coupe	March 4, 2014 – May 16, 2019
F86	X6 M Sports Activity Coupe	July 24, 2014 – May 8, 2019

## AFFECTED VEHICLES

Vehicles which require this Recall Campaign to be completed will show it as Open when checked either in AIR, the Service Menu of DCSnet (Dealer Communication System), ISPA Next or Warranty Vehicle Inquiry.

## SITUATION

BMW of North America, LLC is conducting a Voluntary Safety Recall (effective November 18, 2019) on Model Year 2015 through 2019 BMW X6 and X6M vehicles that were produced from Start-of-Production through May 2019.

This Safety Recall involves the lower anchor bars in the vehicle's rear seat when specifically attaching a child seat with ISOFIX-type rigid-style connectors.

**This condition is unlikely to occur using LATCH-type flexible-style connector child seats which are the vast majority of child seats used in the US.**

Should rigid-style connectors be used, the lower anchor bars could become damaged over the lifetime of the vehicle. If the lower anchor bar(s) became damaged, this could increase the risk of injury to a child in an ISOFIX-type child seat during a crash.

Recall notice and Q&A have been attached for further information.

## CAUSE

When using child seats with ISOFIX mounting and additional support on the vehicle floor, it can lead to fatigue fractures of the ISOFIX retaining brackets.

## CORRECTION

The technician will weld 4 ISOFIX reinforcement plates onto the vehicles ISOFIX retaining brackets.

## PROCEDURE

See attached repair procedure.

See Repair Instruction video [V520120](#).

**Repair Scenario B - Repair Order Invoicing for Claim Submission: CCRC or body shop complete repairs**

On your center's repair order line item for this Service Action on an Affected Vehicle, invoice the required non-bulk part numbers and provide these items to the CCRC (Certified Collision Repair Center) or associated body shop that is performing this repair.

The CCRC or associated body shop will include the remaining material repair cost on their repair invoice.

The claim submission for repair Scenario B will include the BMW part numbers invoiced on the RO that your center provided and the CCRC or associated body shop repair invoice portion in sublet at cost.

## **PARTS INFORMATION**

**Only use and invoice the part numbers below.**

**Please refer to the Parts Matrix for ordering procedure.**

**Performing a part number look-up in ETK (EPC) by VIN or model in place of using/invoicing the following part numbers may result with the wrong part numbers being invoiced and installed, this could delay the payment of claim.**

Part Number	Description	Quantity
07 14 9 137 669	M10x24 oval head screw	8
52 20 4 A08 D40	Reinforcement plate of ISOFIX retaining bracket	4
72 11 9 122 425	Oval/Fillister Head Screw ( <b>M12</b> diameter)	1

And:

**Bulk Material (Claimed separately for repair Scenario A and C only)**

Part Number	Description	Quantity
51 91 2 347 904	1K Primer Aerosol (14 oz.)	Sublet as needed

## **WARRANTY INFORMATION**

Refer to Attachment.

<b>Defect Code:</b>	<b>0052920200</b>	<b>F16 F86 Rework the ISOFIX retaining strap</b>
---------------------	-------------------	--

### **Alternative Mobility Solution (AMS) for Vehicle Owners (RO and Claim Comments Required)**

Please refer to [SI B01 29 16](#) for additional Warranty information.

Supporting Materials

[picture\\_as\\_pdf B522419 Attachment Warranty Information 4\\_2020.pdf](#)

[picture\\_as\\_pdf B522419 REP 52 26 008 Remove side section.pdf](#)

[picture\\_as\\_pdf B522419 ISOFIX-19V-823-QA-\(27Apr2020\).pdf](#)

[picture\\_as\\_pdf B522419 REP 52 26 005 Unclip rear seat.pdf](#)

[picture\\_as\\_pdf B522419 REP 52 26 012 Removing right backrest.pdf](#)

[picture\\_as\\_pdf B522419 REP 51 26 Removing and install crossmember.pdf](#)

[picture\\_as\\_pdf B522419 REP 51 47 128 Remove trunk trim floor.pdf](#)

[picture\\_as\\_pdf B522419 REP 52 26 011 Remove left rear seatback.pdf](#)

[picture\\_as\\_pdf B522419 Recall Notice.pdf](#)

[picture\\_as\\_pdf B522419 Repair Procedure.pdf](#)

[picture\\_as\\_pdf B522419 REP 51 47 135 Remove lashing rails.pdf](#)

Videos

[52 01 20](#)



## **SAFETY RECALL NOTICE**

To: All Center Operators, Sales Managers, Service Manager, Parts Manager and Warranty Processor

RE: Recall 19V-823: ISOFIX Child Seat Anchors – B52 24 19

BMW of North America, LLC is conducting a Voluntary Safety Recall (effective November 18, 2019) on Model Year 2015 through 2019 BMW X6 and X6M vehicles that were produced from Start-of-Production through May 2019.

**Please be reminded that it is a violation of federal law (The Safety Act) for you to sell, lease or deliver any new motor vehicle covered by this notification until the recall repair has been performed. This means that centers may not legally deliver new motor vehicles to consumers until they are fixed or use/sell replacement equipment/parts subject to this recall. Note also that substantial civil penalties apply to violations of the Safety Act.**

**Also, you should not sell, lease or deliver any Certified Pre-Owned or used vehicles subject to a safety recall until the repair is completed.**

**Please follow any special instructions that we provide to you for the return or disposition of recall parts.**

We appreciate all your assistance with this Recall.

## RECALL CAMPAIGN 19V-823: ISOFIX CHILD SEAT ANCHORS

### WARRANTY INFORMATION

Reimbursement for this Recall will be via normal claim entry utilizing the following information for the repair procedure performed (A, B or C) together with the applicable part numbers listed above:

<b>Defect Code:</b>	<b>0052920200</b>	<b>F16 F86 Rework the ISOFIX retaining strap</b>
---------------------	-------------------	--

<b>Scenario A:</b> Split Repair between a BMW authorized center's <b>workshop (Mechanical)</b> and a <b>CCRC/body shop (welding)</b> or a <b>third-party mobile welding service</b> .
---

**Completion before the first vehicle delivery to a customer or the vehicle is already in the workshop**

Work Pkg	Labor Operation	Description (Plus work)	Labor Allowance
# 1	00 68 790	Removing and installing seat cross member	18 FRU
Or:			
# 2	00 68 791	Removing and installing seat cross member (with extended storage SA493)	20 FRU

Or:

**The vehicle arrives at your center and this Recall Campaign shows open (No other Main work will be performed/claimed during this workshop visit)**

Work Pkg	Labor Operation	Description (Main work)	Labor Allowance
# 3	00 68 211	Removing and installing seat cross member	20 FRU
Or:			
# 4	00 68 212	Removing and installing seat cross member (with extended storage SA493)	21 FRU

And:

**\*Associated work in Sublet (RO and Claim Comments Required)**

<b>Sublet Code 3</b>	Up to \$130.00	Welding the reinforcement plate to the ISOFIX retaining bracket (retrofit) and applying primer to seat cross member
----------------------	----------------	---

And:

**Bulk Material in Sublet (RO and Claim Comments Required)**

<b>Sublet Code 4</b>	Up to \$20.00	Reimbursement for the supported amount of repair-related bulk materials (Do not use the BMW part number for claim submission)
----------------------	---------------	---

Or:

**Scenario B: Entire repair performed under sublet by a CCRC or body shop, maximum amounts as listed below.**

**\*Sublet Repair – (RO and Claim Comments Required)**

<b>Sublet Code 3</b>	Up to \$260.00	Removing and installing seat cross member, welding reinforcement plate to ISOFIX retaining bracket (retrofit) and applying primer coating to seat cross member (Vehicles with or without extended storage SA493)
----------------------	----------------	--

Or:

**Scenario C – The authorized BMW center’s workshop completely performs this Repair**

**Completion before the first vehicle delivery to a customer or the vehicle is already in the workshop**

Work Pkg	Labor Operation	Description (Plus work)	Labor Allowance
# 5	00 68 758	Removing and installing seat cross member, welding reinforcement plate to ISOFIX retaining bracket (retrofit) and applying primer coating to seat cross member	25 FRU
Or:			
# 6	00 68 789	Removing and installing seat cross member, welding reinforcement plate to ISOFIX retaining bracket (retrofit) and applying primer coating to seat cross member (with extended storage SA493)	27 FRU

Or:

**The vehicle arrives at your center and this Recall Campaign shows open (No other Main work will be performed/claimed during this workshop visit)**

Work Pkg	Labor Operation	Description (Main work)	Labor Allowance
# 7	00 68 181	Removing and installing seat cross member, welding reinforcement plate to ISOFIX retaining bracket (retrofit) and applying primer coating to seat cross member	26 FRU
Or:			
# 8	00 68 210	Removing and installing seat cross member, welding reinforcement plate to ISOFIX retaining bracket (retrofit) and applying primer coating to seat cross member (with extended storage SA493)	28 FRU

And:

## Bulk Material in Sublet (RO and Claim Comments Required)

<b>Sublet Code 4</b>	Up to \$20.00	Reimbursement for the supported amount of repair-related bulk materials (Do not use the BMW part number for claim submission)
----------------------	---------------	---

### Claim Repair Comments

Only reference the SIB number and the work package (Pkg) number performed in the RO technician notes and in the claim comments (For example: B52 24 19 WP 1), unless otherwise required by State law.

### \*Sublet (Code 3) - Repair Work (RO and Claim Comments Required)

Invoice the applicable repair work (either **A**: welding portion only; or **B**: complete repair) on the repair order at the actual cost charged with no handling or markup. The sublet amount must also include any discounts or allowances.

Prior to having the third-party perform this repair, determine the appropriate charge for performing the necessary repair-related work procedure (either A or B) by comparing their estimated repair cost against the corresponding amount that is based on your warranty rates.

**It is your center's responsibility to review the estimate to ensure the amount requested for perform this repair work is customary, fair and reasonable. Also, it must not exceed the scope of the repair work that is described in this bulletin.**

### Sublet (Code 4) - Bulk Materials (RO and Claim Comments Required)

Sublet reimbursement calculation for claiming the applicable repair-related bulk material (BMW part numbers) is at the dealer net price amount for the quantity used plus your center's handling (up to \$20.00).

Please itemize the above sublet amounts (Code 3 and/or 4 as applicable) on the repair order and in claim comment section.

And, as applicable:

### Alternative Mobility Solution (AMS) for Vehicle Owners (RO and Claim Comments Required)

This Recall repair qualifies for Alternative Mobility Solution (AMS) expense reimbursement, claim this item under the Defect Code noted above as follows:

- **Sublet Code 2** - Itemize the AMS sublet amount on the repair order and in the claim comment section.

Please refer to SI B01 29 16 for additional information.

BMW Group - AIR: 2019-11-25 / 09:48  
 Retailer: -/-  
 Model: X5 xDrive40e iPerformance  
 Development code: F15  
 Model code: KT03  
 Lead type: KT03

### Repair instruction

## Removing and installing/replacing cross member mounting of the rear seat backrest

5226... | REP-REP-RAF1552-5226X09 - V.1

### 52 26 ... Removing and installing/replacing cross member mounting of the rear seat backrest



#### Necessary preliminary tasks:

- Remove luggage compartment floor trim panel
- Remove luggage compartment wheel arch panels on right and left
- Remove rear seat backrest



#### Removal:

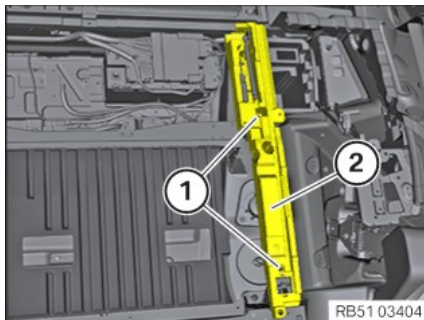

#### Note:

Carry out work on the right side in the same way as for the left side illustrated here.

Release screws (1).

Lift cover (2) such that the screw below is accessible.

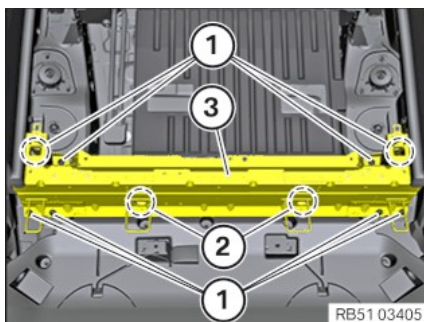

Release screws (1).

Unfasten screws (2).

Remove the cross member mounting for the rear seat backrest (3).



#### Installation:

Install cross member mounting of the rear seat backrest (3).



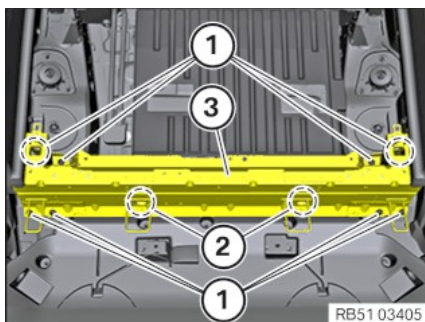

Tighten down screws (1).

Tightening torque 52 26 32AZ.

Tighten down screws (2).

Tightening torque 52 26 33AZ.

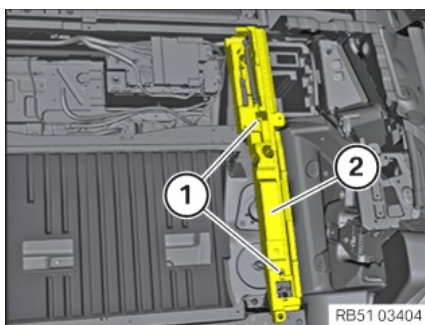

**Note:**

Carry out work on the right side in the same way as for the left side illustrated here.

Install cover (2).

Tighten down screws (1).



**Required follow-up work:**

- Install luggage compartment wheel arch panels on right and left
- Install luggage compartment floor trim panel
- Remove rear seat backrest

BMW Group - AIR: 2019-11-25 / 09:57

Retailer: -/-

Model: X5 xDrive40e iPerformance

Development code: F15

Model code: KT03

Lead type: KT03

#### Repair instruction

### Removing and installing/replacing trim panel for luggage compartment floor

51 47 128 I REP-REP-RAF1551-5147128 - V.3

#### 51 47 128 Removing and installing/replacing trim panel for luggage compartment floor

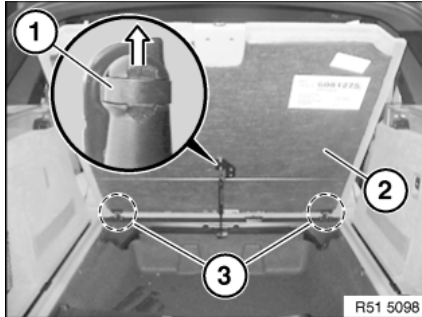

Push retaining spring (1) to end of gas pressure spring.

Remove gas pressure spring from ball head.

Firmly pull luggage compartment floor (2) towards the rear and thereby detach it from hinges (3).

**Note:**

Removal is easier the flatter the luggage compartment floor (2) is positioned.

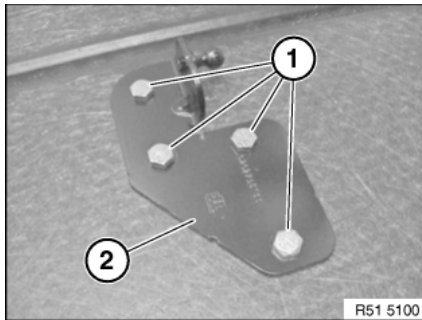

**Replacement:**

Remove handle on trim panel for luggage compartment floor.

Release screws (1).

Remove mounting plate (2).

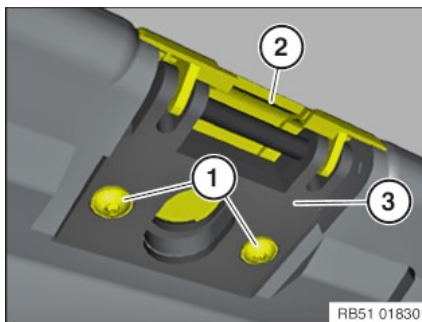

Release screws (1).

Remove cover (2) and retaining hook (3).

BMW Group - AIR: 2019-11-25 / 09:58  
Retailer: -/-  
Model: X5 xDrive40e iPerformance  
Development code: F15  
Model code: KT03  
Lead type: KT03

#### Repair instruction

### Removing and installing/replacing left or right lashing rail in luggage compartment floor

51 47 135 I REP-REP-RAF1551-5147135 - V.2

#### 51 47 135 Removing and installing/replacing left or right lashing rail in luggage compartment floor



#### Necessary preliminary tasks:

- Remove luggage compartment wheel arch panel

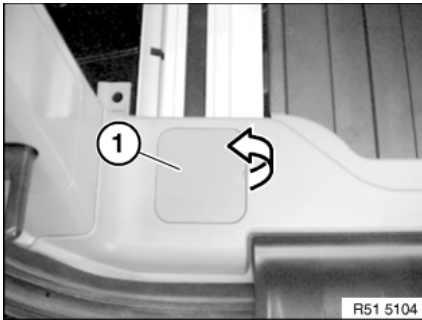

Lift off cover (1).

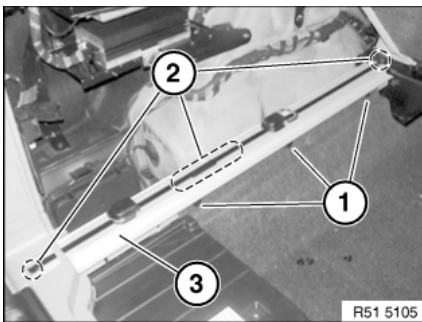

Release clamps (1).

Unfasten screws (2).

Tightening torque 51 47 15AZ.

Feed out lashing rail (3) to the front.

BMW Group - AIR: 2019-11-25 / 09:56  
Retailer: -/-  
Model: X5 xDrive40e iPerformance  
Development code: F15  
Model code: KT03  
Lead type: KT03

[Removing and installing/replacing backrest for left rear seat \(through-loading facility\) »](#)

## Removing and installing/replacing rear seat (through-loading facility)

REP-REP-RAF1552-5226005 - V.4

### 52 26 005 Removing and installing/replacing rear seat (through-loading facility)

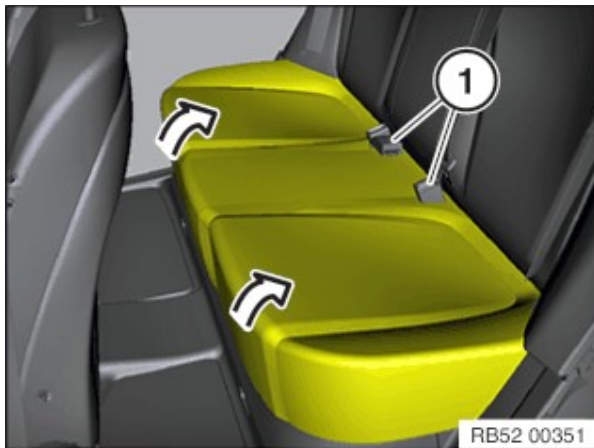

Unclip rear seat on left and right towards top.

***Installation note:***

Feed seat belt buckles (1) into recesses in rear seat.

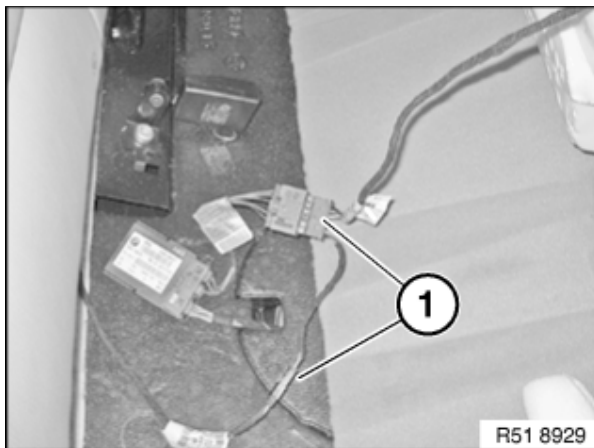

Only on vehicles with seat heating and/or rear compartment blower:

Unlock plug connections (1) and disconnect.

F15 Complete removal only:

Release screw (1) on seat belt (middle).

Tightening torque 72 11 22AZ.

***Installation note:***

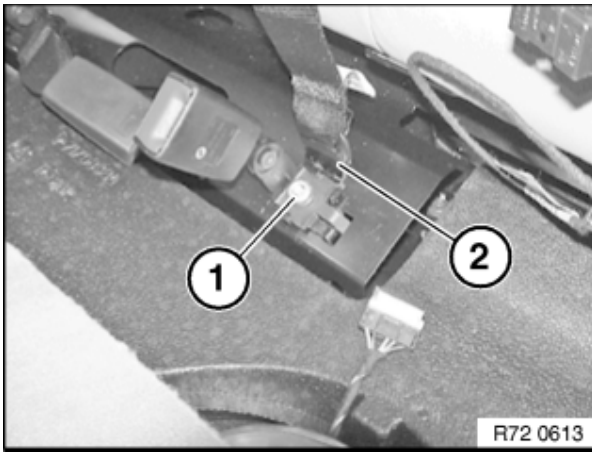

Seat belt is coded against incorrect installation.

Feed out anchor fitting (2) through rear seat.  
Lift out rear seat.

BMW Group - AIR: 2019-11-25 / 09:55  
Retailer: -/-  
Model: X5 xDrive40e iPerformance  
Development code: F15  
Model code: KT03  
Lead type: KT03

Removing and installing/replacing backrest for left rear seat (through-loading facility) »

## Removing and installing/replacing left/right backrest side section of rear seat backrest (through-loading facility)

REP-REP-RAF1552-5226008 - V.3

52 26 008

Removing and installing/replacing left/right backrest side section of rear seat backrest (through-loading facility)

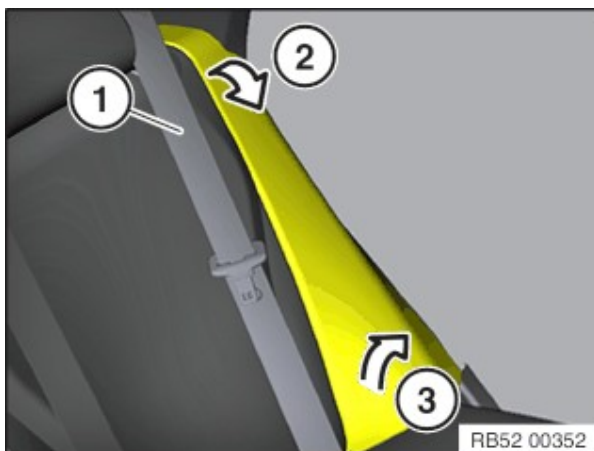

Pull seat belt (1) to middle and place behind head restraint.

Unclip backrest side section in direction of arrow (2) towards front and pull out in direction of arrow (3).

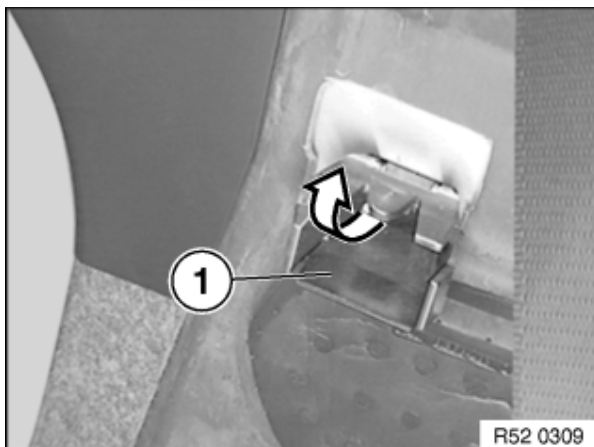

If necessary, pull out clamp (1) towards front.

Check clip (1) and locator (2) for damage.

Snap clamp (1) into locator (2) of backrest side

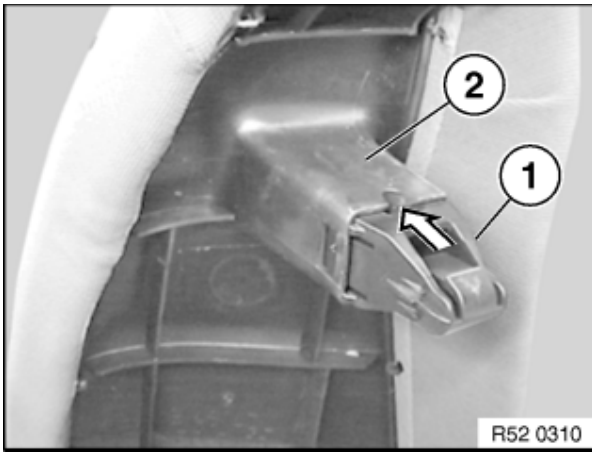

section.

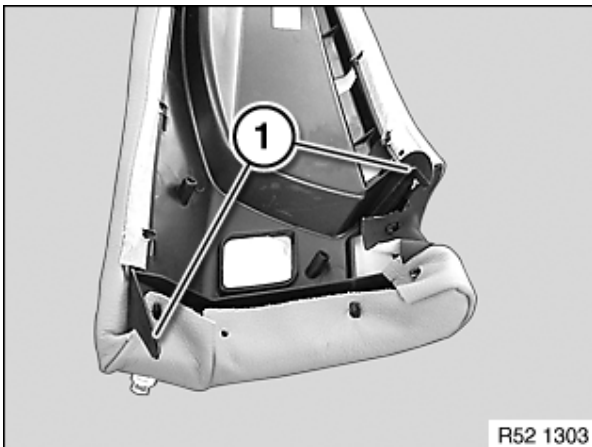

Insert guides (1) into locators.

clamp backrest side section at top into place.

***Installation note:***

Make sure backrest side section is correctly seated in locators.

BMW Group - AIR: 2019-11-25 / 09:54

Retailer: -/-

Model: X5 xDrive40e iPerformance

Development code: F15

Model code: KT03

Lead type: KT03

## Repair instruction

### Removing and installing/replacing backrest for left rear seat (through-loading facility)

52 26 011 | REP-REP-RAF1552-5226011 - V.3

#### 52 26 011 Removing and installing/replacing backrest for left rear seat (through-loading facility)



#### Necessary preliminary tasks:

- Remove armrest side section
- Remove rear seat

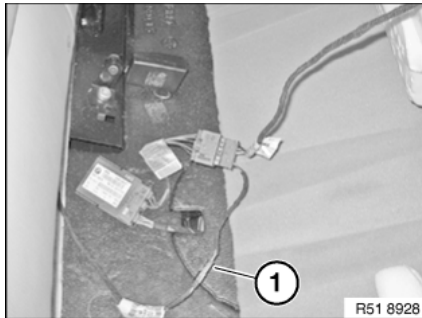

#### For seat heating optional extra only:

Unfasten plug connection (1) and disconnect.

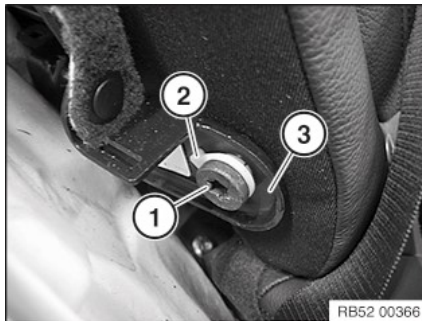

Release screw (1).

Tightening torque 52 26 04AZ.

#### ***Installation note:***

Make sure plastic bush (2) is fitted correctly in the outer mount (3).

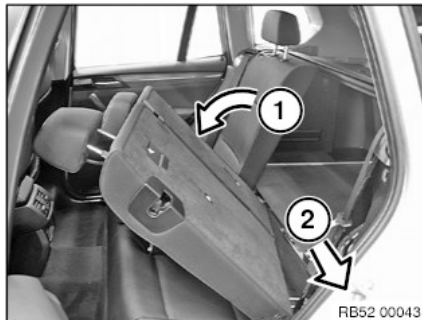

1. Tilt backrest slightly forwards.
2. Pull backrest forwards and outwards out of centre mount

#### ***Installation note:***

Make sure plastic bush (1) is fitted correctly in the centre



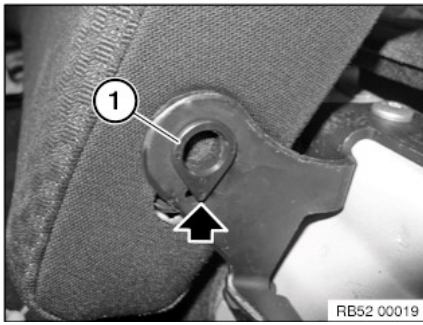

mount.

The plastic bush (1) must be retained in the centre mount with a lug.

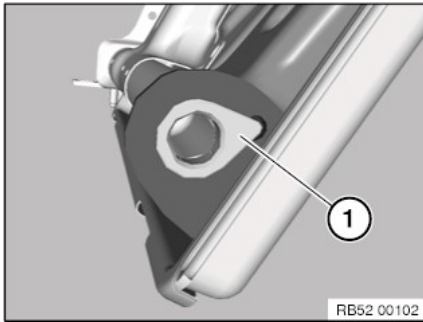

***Installation note:***

Make sure plastic bush (1) is fitted correctly in the right backrest frame.

The plastic bush (1) may slide during removal of the left backrest.

The plastic bush (1) must be retained in the backrest frame with a lug.

If applicable, partially remove the backrest cover and clip the plastic bush (1) in from the outside in.

BMW Group - AIR: 2019-11-25 / 11:14  
Retailer: -/-  
Model: X6 xDrive50i  
Development code: F16  
Model code: KU63  
Lead type: KU63

#### Repair instruction

### Removing and installing/replacing backrest for right rear seat (through-loading facility)

52 26 012 | REP-REP-RAF1652-5226012 - V.2

#### 52 26 012 Removing and installing/replacing backrest for right rear seat (through-loading facility)



#### Necessary preliminary tasks:

- Remove right luggage compartment wheel arch panel.



Release screws (1).

Tightening torque 52 26 02AZ.

Pull out backrest outwards from the centre mount.

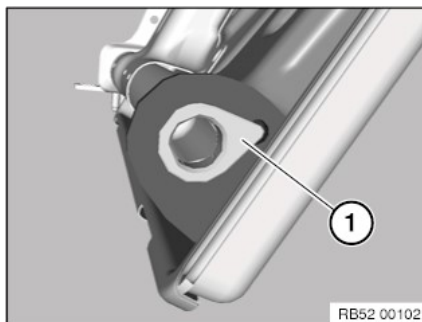

#### **Installation note:**



Make sure plastic bush (1) is fitted correctly in the backrest frame.

The plastic bush (1) must be retained in the backrest frame with a lug.

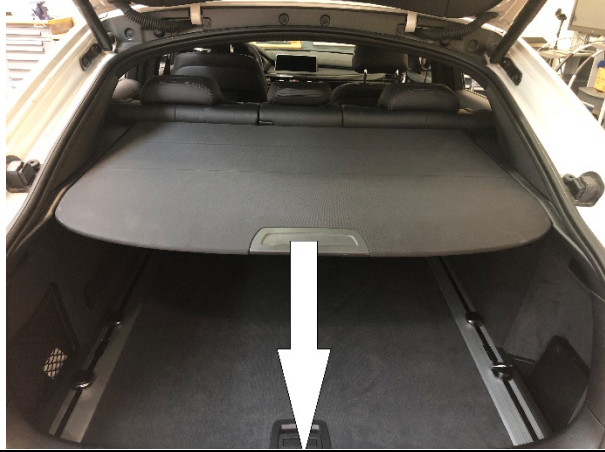
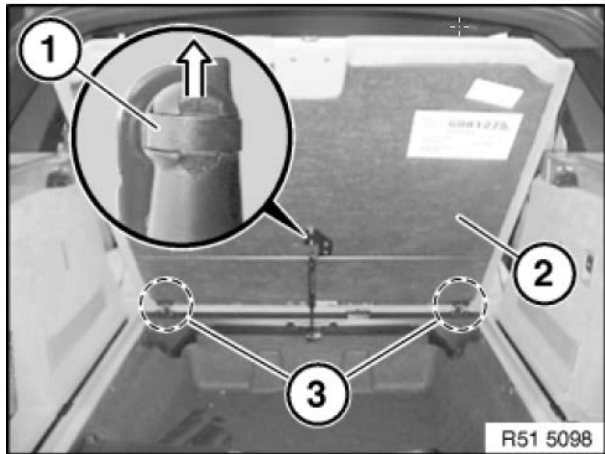
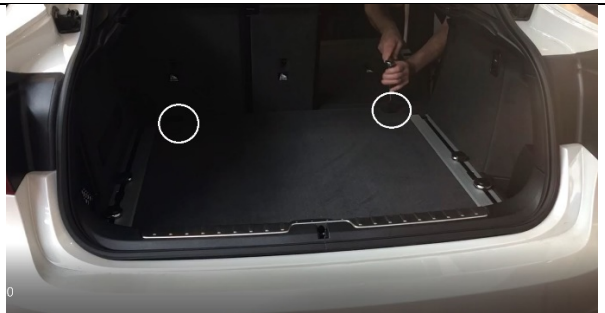

If applicable, partially remove the backrest cover and clip the plastic bush (1) in from the outside in.

**RECALL CAMPAIGN 19V-823: ISOFIX CHILD SEAT ANCHORS**

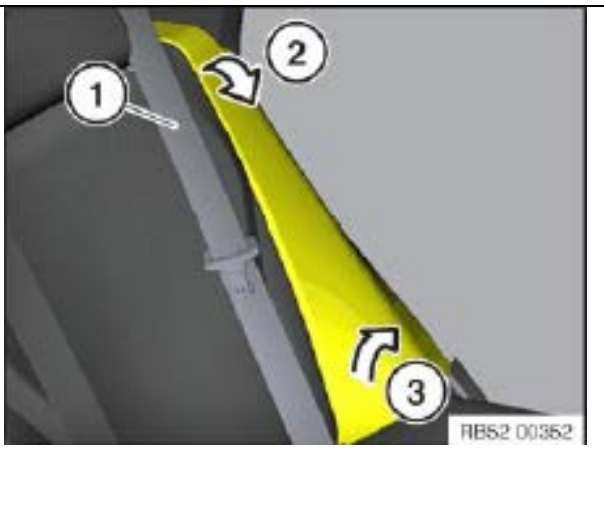
	<p><b>Note: Step 25 revised.</b></p> <ol style="list-style-type: none"> <li>1. Remove luggage cover by pulling toward the rear of the vehicle.</li> </ol>
	<ol style="list-style-type: none"> <li>2. Removing luggage compartment floor trim. Lift up luggage compartment floor.  Unclip the gas pressure spring off the ball head (1) so it no longer holds the floor up.  Follow Repair Instructions <b>RA 51 47 128</b> Removing and installing (replacing) luggage compartment floor trim.</li> </ol>
	<ol style="list-style-type: none"> <li>3. Close luggage compartment floor. Lift plastic cover at hinge of floor to expose bolt. Use T40 socket to remove both bolts. Remove luggage compartment floor from vehicle.</li> </ol>

	<p>4. Remove Battery cover. There are five 8mm bolts holding it in place.</p>
	<p>5. ONLY For vehicles with the SA493 (storage package), the lashing rails must also be removed. There are 4 T40 bolts holding each side. Three bolts are short, and one is long. The longest bolt goes in the hole closest to the front of the vehicle.</p> <p>Follow Repair Instructions <b>RA 51 47 135</b> Removing, installing / replacing the lashing rail in the luggage compartment floor left or right</p>
	<p>6. Remove left / right backrest side section</p> <p>Follow Repair Instructions <b>RA 52 26 008</b> Removing and installing/replacing left/right backrest side section of rear seat backrest (through-load)</p> <p>There are four panel pop clips holding each side in place.</p>

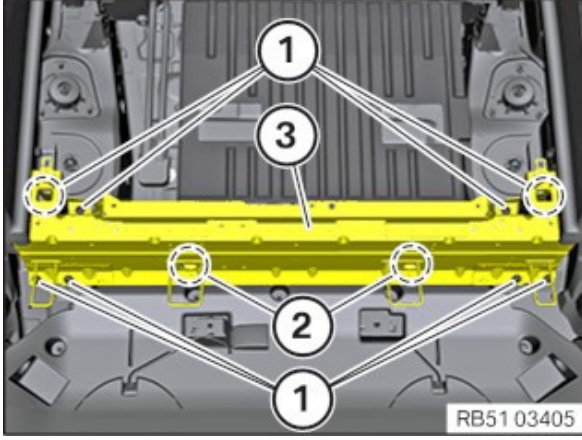
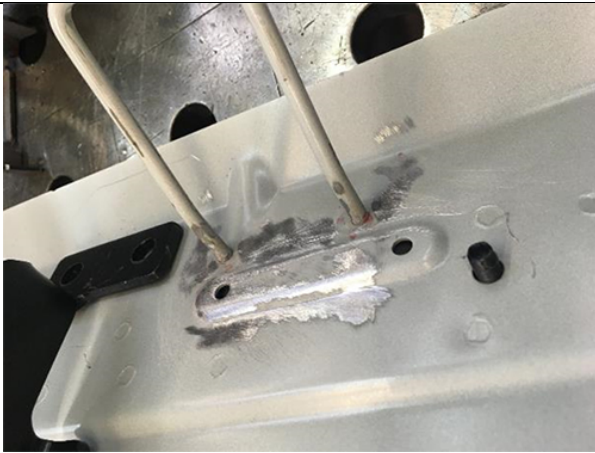
	<p>7. Remove lower rear seat</p> <p>Follow Repair Instructions <b>RA 52 26 005</b> Removing and installing/replacing rear seat (through-load)</p>
	<p>8. Remove upper left rear seat</p> <p>Follow Repair Instructions <b>RA 52 26 011</b> Removing and installing / replacing left rear seat backrest (through-load) backrest.</p> <p>The shoulder belt on this seat must be unbolted from the floor to remove the seat.</p>
	<p>9. Remove upper right rear seat</p> <p>Follow Repair Instructions <b>RA 52 26 012</b> Removing and installing / replacing right rear seat backrest (through-load) backrest</p>

	<p>10. Remove the seat cross member</p> <p>Follow Repair Instructions <b>RA 52 26 xxx</b> Crossmember Removing and installing / replacing rear seat backrest.</p> <p><b>This may not come up when searching F16/F86. To locate this Repair Instruction manually select the F15 PHEV in vehicle selection.</b></p> <p>After the crossbeam has been removed, it must be fixed in a vice for welding.</p>
	<p>11. With the crossbeam bracket positioned in a vise, remove protective coating off metal exposing bare metal. We must have clean metal to ensure a strong weld.</p> <p>Repeat this for all 4 ISO-FIX U shaped brackets.</p> <p><b>This metal prep and welding should be done far away from customer vehicles to ensure no consequential damage occurs.</b></p>
	<p>12. Position the 4 new reinforcement brackets to ISO-FIX bracket as shown.</p> <p><b>(P/N 52 20 4 A08 D40)</b></p>



13. Position new reinforcement bracket to ISO-FIX bracket as shown



14. Position new reinforcement bracket to ISO-FIX bracket as shown

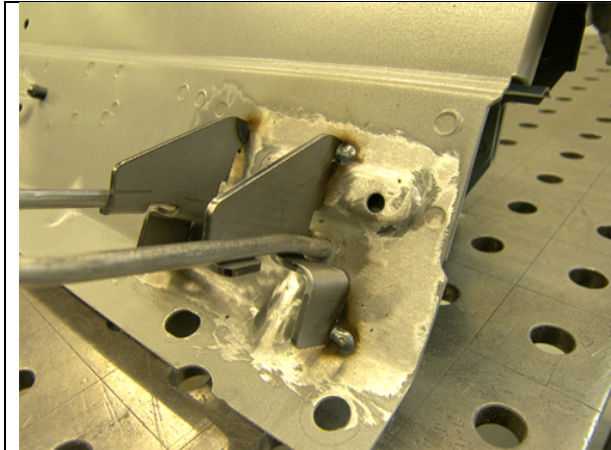

15. Once bracket position is correct, and it sits flush as indicated in the three previous pictures, then you can tack weld the bracket into place.

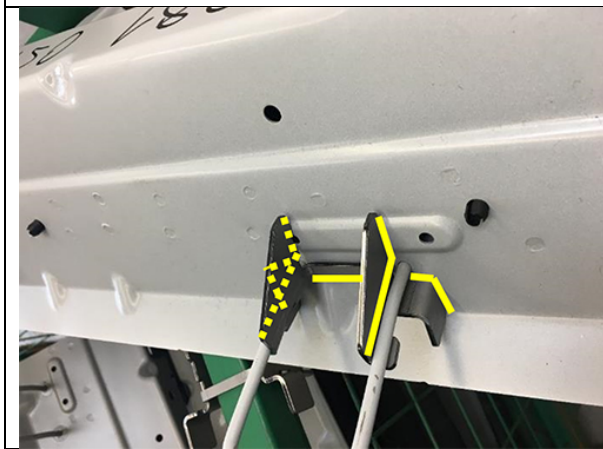

16. A continuous weld bead should be applied at the yellow lines.

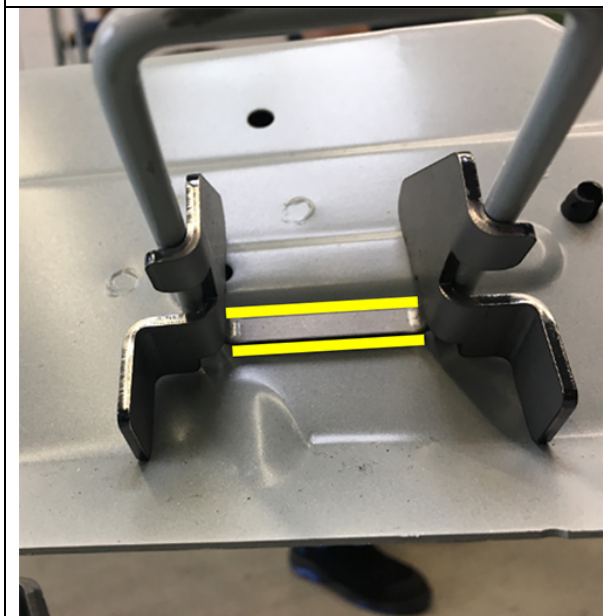

17. A continuous weld bead should be applied at the yellow lines.



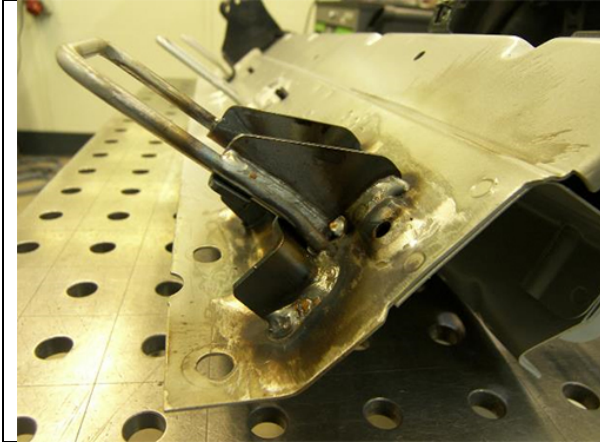





18. Example of properly executed weld is shown. Notice, the welding bead is continuous.

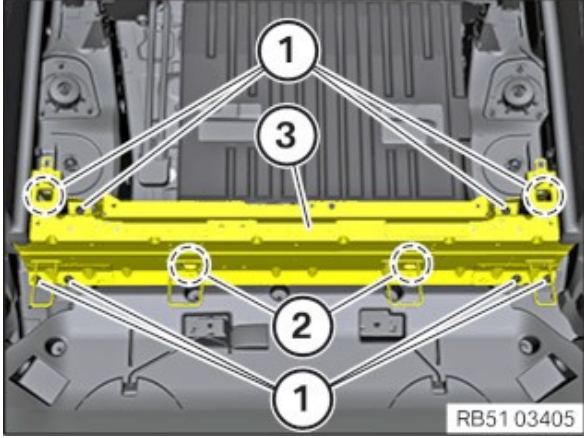

19. Example of properly executed weld is shown. Notice, the welding bead is continuous.

	<p>20. Example of properly executed weld is shown. Notice, the welding bead is continuous.</p>
	<p>21. Once all 4 reinforcement brackets are welded into place, and the welds have cooled, prepare the area to reapply anti-corrosion protection. Use a stainless brush to clean the weld before applying anti-corrosion protection.</p> <p>Anti-Corrosion protection can be sprayed on or applied with a brush.</p> <p>The back part of this crossbeam bracket is visible when the load floor is lifted up so the paint color used should match the existing paint already used on this part. (if you don't have matching paint, you can tape off the back part of this bracket before painting the repair)</p> <p>The front part of the crossbeam bracket is hidden behind the seat backrest so the paint color used on this side does not matter.</p>

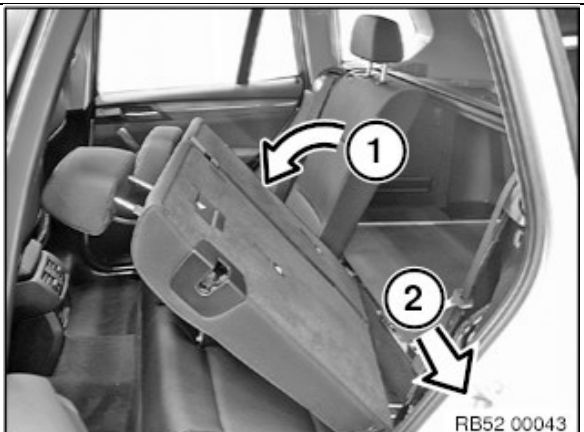
	<p>22. Install the seat cross member</p> <p><b>(1) These 8 bolts (M10x24) must be replaced once removed. (P/N 07 14 9 137 669)</b></p> <p>Torque the Oval head screw to 40 Nm</p>
	<p>23. Install upper right rear seat</p> <p>Make sure the plastic bushing is installed around the seat bolt</p> <p>Torque the bolt to 71 Nm</p>
	<p>24. Install upper left rear seat</p> <p>Make sure the plastic bushing is installed around the seat bolt</p> <p>Torque the bolt to 71 Nm</p>

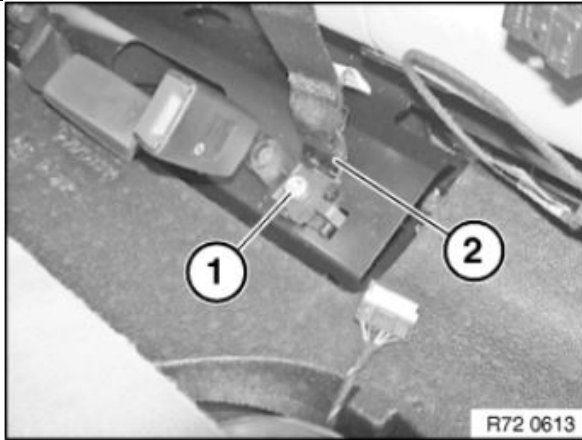

25. The shoulder belt on the rear left seat must be bolted to the floor to install the seat.

**This bolt must be replaced once removed. The replacement bolt used must match the bolt diameter removed.**

**For original M12 bolts use replacement bolt P/N 72 11 9 122 425**

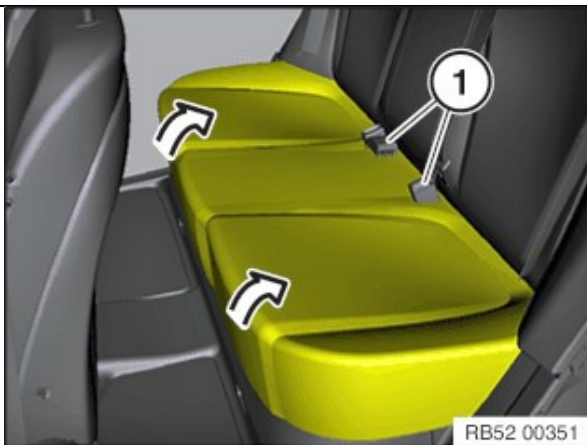

Torque new bolt to 63 Nm

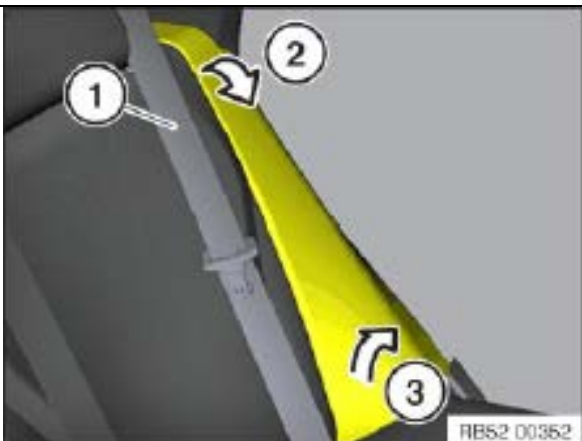

26. Install lower rear seat



27. Install left / right backrest side section

	<p>28. ONLY For vehicles with the SA493 (storage package), the lashing rails must be installed.</p> <p>There are 4 T40 bolts holding each side. Three bolts are short, and one is long. <b>The longest bolt goes in the hole closest to the front of the vehicle.</b></p> <p>Torque the bolts to 20 Nm</p>
	<p>29. Install Battery cover.</p>
	<p>30. Install luggage compartment floor.</p>

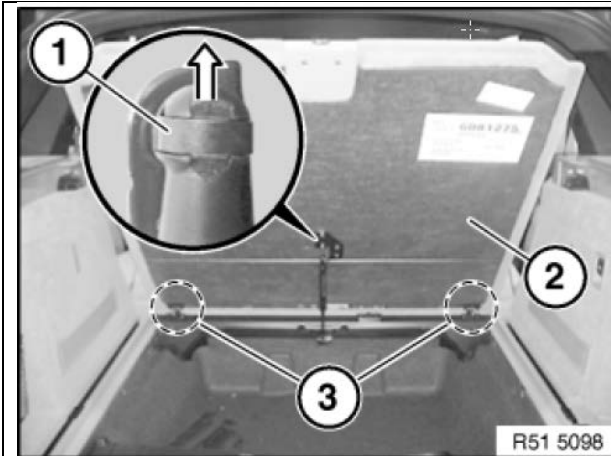

31. Install luggage compartment floor trim.



32. Install luggage cover

**ISOFIX Child Seat Anchors  
Safety Recall 19V-823  
Model Year 2015-2019  
*Last Updated 04/27/2020***

**Q1. Which BMW models in the US are potentially affected by this Safety Recall?**

Approximately 32,760 Model Year 2015-2019 BMW X6 and X6M vehicles in the US, produced between March 2014 and May 2019, are potentially affected.

**Q2. What is the specific issue?**

This Safety Recall involves the lower anchor bars in the vehicle's rear seat when specifically attaching a child seat with ISOFIX-type rigid-style connectors. **This condition is unlikely to occur using LATCH-type flexible-style connector child seats which are the vast majority of child seats used in the US.** Should rigid-style connectors be used, the lower anchor bars could become damaged over the lifetime of the vehicle. If the lower anchor bar(s) became damaged, this could increase the risk of injury to a child in an ISOFIX-type child seat during a crash.

Please refer to the image below illustrating a child seat with rigid-style connectors.



**Q3. Can I continue to drive my vehicle?**

Yes. However, when you receive a letter requesting you to make an appointment to have this Safety Recall performed by an authorized BMW center, please do so as soon as possible. If you are not the only driver of this vehicle, please advise all other drivers of this important information.

**Q4. Why are other BMW vehicles not included in this Safety Recall?**

The lower anchor bars on other vehicles do not have the same configuration.

**Q5. How did BMW become aware of this issue?**

BMW became aware of this issue through its quality control procedures.

**Q6. How will my vehicle be repaired?**

A reinforcing bracket will be welded to the lower anchor bars and the vehicle body for free and will take several hours.

**Q7. Is BMW aware of any accidents or injuries in the US, involving these BMW vehicles associated with this Safety Recall?**

No.

**ISOFIX Child Seat Anchors**  
**Safety Recall 19V-823**  
**Model Year 2015-2019**  
**X6 / X6M**  
***Last Updated 04/27/2020***

**Q8. Can I determine if this issue exists in my vehicle?**

This issue has only been known to occur with ISOFIX-type rigid-style connector child seats. Therefore, if you use a LATCH-type flexible-style connector child seat, your vehicle is unlikely to experience this condition.

When using a rigid-style connector child seat, this issue could be noticed when attempting to attach the child seat if the lower anchor bar is loose. It could also be noticed during vehicle operation if the child seat appears to be loose.

If you notice either of the conditions described above, place your hand between the seat back and seat cushion to locate the lower anchor bars. They are small metal bars in a rectangular shape. Once located, make an attempt to move them back and forth to determine if they are loose. If they appear to be loose, please contact an authorized BMW Center to have your vehicle inspected and, if necessary, repaired.

**Q9. How will I be informed of this Safety Recall?**

You will receive a letter in January via First Class mail advising you of this Safety Recall and, if parts are available, requesting you to schedule an appointment with an authorized BMW center to have this Safety Recall performed. You can locate your nearest authorized BMW center at [www.bmwusa.com/dealer](http://www.bmwusa.com/dealer). If parts are not available, you will receive a follow-up letter when parts become available, requesting you to schedule the recall at that time.

To ensure BMW Group has the most recent contact and vehicle information, owners should register their vehicle at [www.bmwusa.com/myBMW](http://www.bmwusa.com/myBMW). Registration is free, and will give them access to factory initiated campaigns and other information specific to their BMW.