

Oh TO: Mercedes-Benz Dealer Principals, General Managers, Sales Managers, Service Managers, Parts Managers	FROM: Gregory Gunther, Department Manager, Vehicle Compliance and Analysis, Engineering Services
RE: Recall Campaign UPDATE – 2019090009 Takata PG6 DRIVER and PASSENGER AIRBAGS Additional 2010 - 2011 E-Class Coupes and MY2011 Cabrios (207)	DATE: October 31, 2019

IMPORTANT TAKATA RECALL CAMPAIGN INFORMATION

This is to notify you of additional MY2010-2011 E-Class Coupes, and MY2011 Cabriolets (207) being launched today under campaign 2019090009 to replace both front driver-side airbag and front passenger-side airbags on approximately 2,889 affected subject vehicles in the Non-A zone. Affected vehicles will be flagged as “Open” in VMI on October 31st, 2019.

Parts:

- Are now available and must be ordered on a VIN basis
- Replacement rate is 100%.
- Any vehicles still flagged with “Pending” are not yet included in this wave of the recall launch.

Owner Notifications: Customer letters will be mailed on approximately **November 6th, 2019**.

Note: VMI must always be checked before performing campaigns to verify that the campaign is required on a specific vehicle. Always check for any other open campaigns, and perform accordingly.

Recall information for customers:

- Mercedes-Benz specific recall-related information: www.mbusa.com/mercedes/recall
- Mercedes-Benz Customer Assistance Center: **1-877-496-3691**
- Industry-wide Takata information: www.nhtsa.gov/recall-spotlight/takata-air-bags

Work Instructions: Work Instructions will be posted to STAR TekInfo on October 31, 2019, and are attached to this notice for reference.

Please note that all customer inquiries should be directed to the Customer Assistance Center at **1-877-496-3691**.

Sincerely,

Gregory Gunther

Department Manager, Vehicle Compliance & Analysis



Recall Campaign Launch Notification

October 31, 2019

Campaign No. :

NHTSA ID: 16V081

Campaign Desc. :

Takata Recall - PG 6

2019090009

**16V363/17V017
18V043/19V010**

19P9194006

Driver and Passenger Airbag

This is to notify you of the **Recall Campaign UPDATE** to include approximately **2,889** Model Year ("MY") 2010-2011 E-Class Coupes and MY2011 Cabriolet (207) Vehicles in the Non-A zone to Campaign 2019090009 to replace the front driver-side and passenger side airbags. The recall campaign will be visible on the www.safercar.gov website and may generate questions from customers. Please note that this update only accounts for a subset of a larger recall population initially identified in a prior NCU distributed on September 25th, 2019. **Affected VINs will be flagged in VMI as "OPEN" on October 31, 2019.**

Background

Issue
Based on the defect decision of TK Holdings, Inc. ("Takata"), in certain frontal airbags produced by Takata used in certain Model Year 2010-2011 Mercedes-Benz vehicles, under specific circumstances, the front driver-side and/or passenger-side airbag inflator housing may explode during deployment due to excessive internal pressure. This condition is more likely to occur if the vehicle has been exposed to high levels of absolute humidity for extended periods of time. A frontal airbag inflator explosion during deployment could result in sharp metal fragments striking the driver or other occupants, possibly causing serious injury or death. To remedy this concern, an authorized Mercedes-Benz Dealer will replace the front driver-side and passenger-side airbags.

What We're Doing
An authorized Mercedes-Benz Dealer will replace the front driver-side and passenger-side airbags for affected vehicles. The steering wheel will not be replaced.

Parts
Dealers must place VIN-specific orders based on the process outlined in the November 9th, 2018 NCU from Supply Chain Management. Airbags will not be allocated to dealers and are Non-returnable.

Vehicles Affected by Update

Vehicle Model Year(s) MY10-11
Vehicle Model E-Class Coupes/Cabriolet (207) vehicles

Vehicle Populations

Total Recall Population 68,669 Vehicles (September Launch) **2,889 (October Launch)**

Next Steps/Notes

Customer Notification Timeline Customer letters will be mailed on November 6th, 2019

AOMS/SOMS This recall may initiate questions from customers and the media. Please ensure your dealers have read and understand this notice.

Rental Fleet Partners This recall may affect vehicles in your fleet. Please contact your respective MBUSA fleet representative for further information and next steps. For repairs, please contact your preferred MBUSA dealer.

Notes

- Follow ALL steps of the work Instructions, and ensure Dealer Technicians view the AKUBIS videos.
 - Payment of claim will be tied to technician viewing video for this recall.
- Any vehicles flagged with "Pending" are **NOT yet** included in this wave of the recall.
- Utilize **MBSelect Plus** when appropriate - see NCU posted February 16, 2018
- Recall information for customers:
 - Mercedes-Benz specific recall-related information: www.mbusa.com/mercedes/recall
 - Mercedes-Benz Customer Assistance Center: **877-496-3691**

Industry-wide Takata information: www.nhtsa.gov/recall-spotlight/takata-air-bags

While we regret any inconvenience this may cause, MBUSA is determined to maintain a high level of vehicle quality and customer satisfaction. Please refer all customer inquiries to the Customer Assistance Center at 1-877-496-3691.



General Information

- Ensure that every dealership associate is aware of the Takata recall, and that customer-facing associates provide transparent information to customers.
- Refer to VMI in NetStar to determine which units in your inventory are affected by this safety recall. All vehicles with affected driver-side and passenger-side airbags are flagged, with a status of "Open".
- Run a VMI check on all vehicles brought into your Service department to determine if they are affected by any recall.
- Always act with the principles of Customer Experience in mind.
- We have updated the www.mbusa.com/recall website to provide airbag part availability based on current registered State, Model Year, and Model. This will allow customers and dealers to look up general airbag replacement part availability independent of VIN. The output table below on the right will display which airbags are affected, and when the replacement airbag(s) will be available. Visit the website and select the respective information from the dropdown tables to see the airbag availability date. (See Part Availability Tool pictures below)

Takata Replacement Airbag Availability

Please search for your vehicle using the options below. Only Takata-affected vehicles are listed. To check other recall information, please use the VIN Lookup Tool above.

Registration:

Note: If you cannot find your Make/Model/Model Year, your model is not involved in the Takata Recall.

Model Year:

Model:

[Check Recall Status](#)



Airbag Availability for: 2012 GLK-Class, FL

Affected Airbag Position	Estimated Part Availability Date
Drivers Side	March 2019
Passenger's Side	March 2019

You will be notified when parts are available at an authorized Mercedes-Benz dealership for your vehicle. If parts are available, please use the dealer locator tool below and schedule an appointment for your **FREE** repair.

*Please note that vehicles included in this recall have been organized into priority groups according to the state in which the vehicle is registered. A change in state registration may affect the vehicle's inclusion in a priority group.

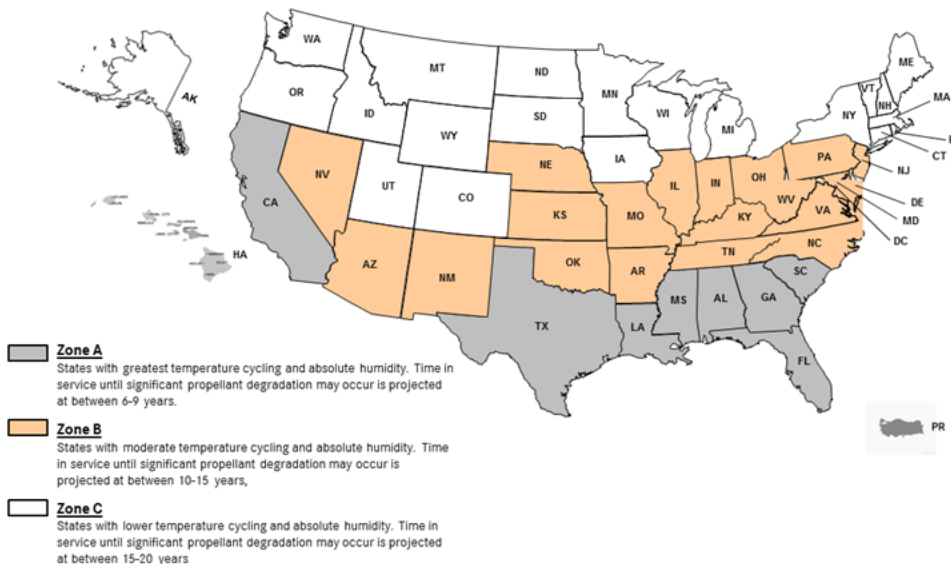

FAQ's

Which Models and MY's are affected in this Priority Group 6 Driver-side and Passenger-side airbag recall update? See vehicle chart below. However, please remember to **always check VMI!**

Model	Year(s)
E350 Coupes	2010-2011
E350 Cabrios	2011
E500 Coupes/Cabrio	2010-2011
E500 Cabrios	2011

My SRS lamp is on now; will the dealer repair my car with the same affected part?

An illuminated SRS lamp can be caused by numerous components or even low battery voltage. An authorized Mercedes-Benz dealer can offer assistance diagnosing the SRS light as well as offer assistance repairing the issue through various incentive programs outlined in our recall repair instructions. Please review Attachment A for additional information.

The customer's vehicle has come into my workshop and has a different steering wheel than the original production steering wheel. How do I proceed with the repair?

If the customer's vehicle has a different Mercedes-Benz steering wheel and airbag module, please remove the airbag module and take detailed photographs of the labels on the module, including the part numbers. Please send the photographs in a zip folder to your AOM with a request to forward to MBUSA for further investigation. MBUSA will then advise as to the correct part number to use for the repair or will close the campaign out manually if the airbag does not have to be replaced. Please see below example image of label.

Please note: If the vehicle comes in with a new steering wheel that does not have an airbag (such as a racing steering wheel) please send photographs in a .zip file to your AOM who will contact MBUSA. MBUSA will then close out the campaign manually.



Is this recall comparable to similar recalls being conducted by other Manufacturers?

Yes. This expanded recall campaign involves the Takata PSPI-5 (driver-side), PSPI-2 or SPI (passenger-side) inflators.

What is the Inflator?

The inflator is a device contained within the airbag assembly. It contains solid propellant wafers that are ignited in the event airbag deployment is necessary. When ignited, the wafers combust and create an inert gas that inflates the airbag.

What other brands of airbags are installed in Mercedes-Benz vehicles?

Various suppliers are used, and the airbag modules with integral inflators are generally specific to each model or model line. Other suppliers include Autoliv and TRW.



If a customer requests it, can the driver or passenger airbag be disabled?

No. Federal Regulations prohibit airbag disablement. Also, as a leader in the safety field, we believe that the driver and passengers are always safer with the protection of the airbag when a collision event warrants a deployment. The airbag is designed to supplement the seatbelt and other restraint components. For these reasons, we will not authorize dealers to disable airbags.

Can I get a loaner vehicle or alternate transportation until the parts are ready?

Your dealer will be able to advise you if loaner or alternate transportation is available.

I'm willing to stay in my car, but what is Mercedes-Benz going to do for me given this inconvenience?

We will attempt to minimize any inconvenience and will inform the vehicle owners when parts are available. Please understand that this issue affects the entire automobile industry and is not simply a specific Mercedes-Benz issue.

I demand that another type of airbag brand (not Takata) is installed in my car. Will you do this?

Each airbag needs to meet strict US crash and safety design requirements. Each airbag design must be certified for the application. Therefore, it is not a simple change of supplier. We do not have other suppliers producing inflators to replace affected Takata-supplied PSDI-5 and PSPI-2 and inflators.

Where can a customer have the recall work completed?

Upon receiving the follow-up customer letter informing them that parts are available, our customers will be asked to contact their local authorized Mercedes-Benz dealership to arrange for an appointment to complete the **FREE** repair.

Do I have to wait for a recall repair letter before I can have my vehicle fixed for this recall?

Yes. We are in the process of obtaining the necessary parts to launch the recall. Once they are available, you will be sent a second letter asking you to schedule an appointment with your authorized Mercedes-Benz dealer to perform the repair.

Do I need my owner letter to have the remedy performed?

No, you do not need the owner letter to have this recall completed.

How does a customer know whether their vehicle is affected by the recall?

Any customers who are potentially affected will be mailed an interim letter. Customers can always check if their vehicle is affected by entering their VIN into the following site: www.mbusa.com/mercedes/recall

I'm in the military overseas with vehicle. If my car is affected by this recall, how do I get it taken care of?

Overseas military personnel will receive notices like U.S. customers, and they will be similarly directed when to schedule the remedy service with their authorized Mercedes-Benz dealer.

How does Mercedes-Benz obtain my mailing address?

Mercedes-Benz utilizes the services of an industry provider who obtains mailing information for Recalls based upon each state's Department of Motor Vehicles (DMV) registration or title information for the vehicle. It is important to keep both your registration and title ownership and address information updated with your corresponding state's DMV and dealer. If you lease your vehicle, the lessor appears as the owner of your vehicle, and will receive the Recall notification. To comply with Federal Regulations, it is the responsibility of the lessor to forward a copy of the notice to the lessee within 10 days of receipt.

How will the repair be communicated to MB customers in the US?

Vehicle owners will receive a letter in the mail letting them know parts are available and to bring in their vehicle to their preferred authorized dealer of choice.



When will parts be available?

Parts are currently available for certain vehicle models 204, X204, 164, 203, 251, 207, 212, 197 and 171 in Priority Group 4, Priority Group 5 and 6. We have updated the www.mbusa.com/recall website to provide airbag part availability based on current registered State, Model Year, and Model.

Regarding all other future priority groups, Daimler AG, the manufacturer of Mercedes-Benz vehicles, is working with Takata and NHTSA, within the guidelines of the NHTSA Coordinated Remedy Program to secure parts for the recall repair. At this point we do not have information regarding when those parts will become available.

Are there any vehicle symptoms that would indicate I should stop driving the car or take to a dealer?

No. There is no symptom that would indicate if your vehicle has an air bag inflator that is potentially at risk of rupturing during deployment in a crash.

Do I need to drive differently until my vehicle is repaired?

No. Continue to drive with your seatbelt fastened and properly seated.

Are there concerns with other airbags in the vehicle?

No. This condition only applies to the driver and/or front passenger airbag inflator (check your VIN on www.mbusa.com/mercedes/recall). Other Takata airbags in the vehicle are not affected by this condition.

What makes Mercedes-Benz airbags safer than other affected Takata airbags?

There have been no incidences of an airbag rupture in any Mercedes-Benz vehicles.

I spend my winters in south Florida and have done so for the past 10 years, but my car is registered in a northern state. Why shouldn't my car have a higher priority?

The data collected and examined by NHTSA demonstrates that long-term exposure to combined high heat and humidity creates the risk that a Takata inflator is likely to rupture. A vehicle that "winters" in a hot and humid location is not subjected to the same sustained periods of heat and humidity as a vehicle that has been driven in these conditions year-round for a prolonged period.

What is the expected impact or risks related to this issue?

In a crash where the air bag system deploys, the air bag inflator housing may explode. In the event of an inflator explosion, metal fragments could pass through the air bag material, which may result in injury or death to vehicle occupants. To date, we are not aware of any instances of exploded inflators in Mercedes-Benz vehicles.

What types of repairs or replacements are needed?

Authorized Mercedes-Benz Dealerships will replace the affected driver-side and/or passenger-side airbag for FREE on the affected vehicles when parts become available.

How long does this replacement take?

Replacement is estimated to take up to 3 hours for both the front driver-side and passenger side airbags.

Why are other models not included?

Other models are not included because this recall pertains specifically to vehicles equipped with the Takata PSDI-5 or and PSPI-2 inflators.



When did Daimler become aware of this potential issue? How long has Daimler been aware of this issue?

Daimler was informed that Takata submitted a "Defect Information Report" to NHTSA on January 25, 2016, reporting a potential safety defect on SDI and PSDI-5 airbag inflators. On May 16, 2016, Takata submitted an additional "Defect Information Report" (DIR) to NHTSA that included PSPI-2 passenger-side airbag inflators. On January 3, 2017, Takata submitted another DIR that included additional PSPI-2 passenger airbag inflators. On January 2, 2018, Takata submitted another DIR that included additional PSPI-2 passenger airbag inflators. On January 9, 2019, Takata submitted another DIR that included additional PSPI-2 passenger airbag inflators. We are not aware of any cases with the failure mode reported by Takata on PSDI-5, or PSPI-2 airbag inflators in any of our vehicles.

What costs will be incurred by the customer?

When replacement parts become available, the airbag replacement will be conducted **free of charge to customers**.

Can I continue to drive my vehicle?

Yes. Daimler is not aware of a ruptured inflator in any of its vehicles associated with this recall. However, when you receive a letter asking you to have this service performed by an authorized Mercedes-Benz dealer, please do so as soon as possible. If you are not the only driver of this vehicle, please advise all other drivers of this important information.

Why are only certain vehicles affected within a specific production range?

The affected vehicles were identified based on the "Defect Information Report" submitted by Takata.

How does this recall differ from previous airbag recalls from other OEM's? If there isn't a difference, why is the recall only happening now?

The recalls until this point affected different Takata inflators. For more information on the Takata industry wide situation, please visit this site: www.safercar.gov/rs/takata/index.html

What specific models are impacted for the passenger-side airbag?

With this launch update of Priority Group 6 E-Class Coupes/Cabriolet (207) vehicles have the passenger side airbags included in the recall. Future models/recalls may contain additional passenger-side airbags.

Why are other Mercedes-Benz models not included?

Only vehicles equipped with the Takata PSPI-5 and/or PSPI-2 inflator are included.

Have there been any reported injuries from faulty airbags in Mercedes-Benz vehicles?

We are not aware of any incidences with the affected inflators in Mercedes-Benz vehicles.

Can you guarantee me the airbag will not deploy inadvertently?

The issue with the recalled Takata PSDI-5, or PSPI-2 inflators does not result in inadvertent airbag deployments. Rather, the issue concerns the potential for an explosion during deployment. Visit your authorized Mercedes-Benz dealer if your vehicle's SRS light is illuminated. Please remember too that a properly functioning airbag system is designed to supplement, not replace, the seatbelt in protecting occupants in a crash.

What injuries can I expect if the airbag deploys?

For the affected Takata PSDI-5 and PSPI-2 inflators only, in a crash in which an air bag deployment is necessary, the air bag inflator housing may explode and result in metal fragments passing through the air bag material, which may result in injury or death to vehicle occupants. To date, we are not aware of any instances of ruptured inflators in Mercedes-Benz vehicles.





Mercedes-Benz

Campaign No. 2019090009, Sept 2019
Revision A, October 2019
Additional 207 Vehicles

TO: ALL MERCEDES-BENZ CENTERS

SUBJECT: **Model 204, 207, X204 and 197**

Model Years 2010 – 2015

Replace Driver-Side and Front Passenger-side Airbag

Based on the defect decision of TK Holdings, Inc. ("Takata"), in certain front driver and passenger side airbags produced by Takata used in certain Model Year 2010-2015 Mercedes-Benz vehicles, under specific circumstances, the front driver or front passenger side airbag inflator housing may explode during deployment due to excessive internal pressure. This condition is more likely to occur if the vehicle has been exposed to high levels of absolute humidity for extended periods of time. A front driver or passenger side inflator explosion during deployment could result in sharp metal fragments striking the passenger or other occupants, possibly causing serious injury or death. To remedy this concern, an authorized Mercedes-Benz dealer will replace the front driver and passenger side airbag on the affected vehicles.

Prior to performing this Recall Campaign:

- Please check VMI to determine if the vehicle is involved in the Campaign and if it has been previously repaired.
- Please review the entire Recall Campaign bulletin and follow the repair procedure exactly as described.
- **For more instruction on the SRS light – please see attachment A**

Approximately **71,558** vehicles are involved.

Order No. P-RC-2019090009

This bulletin has been created and maintained in accordance with MBUSA-SLP S423QH001, Document and Data Control, and MBUSA-SLP S424HH001, Control of Quality Records.

**WARNING!**

There is a risk of injury or death when performing testing or repair work on vehicles and when handling vehicle components. Be sure to read and observe all relevant safety instructions in WIS. This procedure must only be performed by trained personnel using proper tools and equipment.



Note: View driver-side and passenger-side airbag replacement videos prior to performing this procedure:

- **Location:** The Learning Link.
- **Course Code:**
 - X0069E-US.MTA (AKUBIS®: Driver's Airbag Replacement).
 - X0070E-US.MTA (AKUBIS®: Passenger's Airbag Replacement)
- Video is for reference purposes, be sure to follow work sequence and instructions in this Procedure.



1. Load the **Mercedes-Benz PartScan** App. on Apple® iPhone® or Android® smart phone.

**Note:**

- For Apple® iPhone® Users: The *MB PartScan* App is designed for generations of iPhone 5s and newer. However, for optimal experience and performance, we advise that an iPhone 6 and newer be used for scanning with the *MB PartScan* App.”
- Download app from Apple® store for iPhone® or Google® play for Andriod® (same as any other app download) then scan the QR code below to continue download (follow on-screen instructions).
- To install and transmit the data a WiFi connection is required.
- After downloading the App, a one-time security authentication is required by means of encrypted QR code. Verification can be performed by scanning the QR code below, before using the application.
- Ensure that only authorized personnel access to the QR Code the workshop receives.
- The following e-mail address is provided in the event UHD App support is required for the **Mercedes-Benz PartScan** App process: Mbdiagnosis@mbusa.com



Figure 1

i **Note:** Prior to replacing airbag, please check for SRS errors or messages in the instrument cluster:

- If an SRS error message is pending before start of work, **it must be documented and accounted for through the details outlined in Attachment A, page 17. Perform the recall repair accordingly.**

Procedure W/C 204

1. Disconnect ground line from the on-board electrical system battery.
2. Remove driver airbag at the steering wheel.
 - i** For basic data of model 204, see **AR91.60-P-0660CW**
 - i** For basic data of model 207, see **AR91.60-P-0660EW**
 - i** For vehicles with code 428, switch up the connector coupling for steering wheel shift paddles, rework to the new driver airbag (**BT54.18-P-0002-01CW**).
 - i** Do not install the new driver airbag at the steering wheel until after the scan procedure in operation step 19.
3. Remove right A-pillar trim (**A, figure 2**).



Figure 2

4. Remove glove box housing
 - i** For basic data of model 204, see **AR68.10-P-1200CW**
 - i** For basic data of model 207, see **AR68.10-P-1400EC**
 - i** Release inner retaining ring (**figure 3**) at the AUX connection towards the inside. The connection can then be removed from the glove box housing.
 - i** Pull iPod cable **with** rubber grommet out of glove box housing until the connector plug makes contact with the housing. **Do not pull cable out of rubber grommet** because it is bonded to the rubber grommet and will otherwise be damaged!

i Pull out the iPod cable as far as possible and set down glove box housing on the windshield *with* exterior iPod cable connected (**figure 4**).



Figure 3



Figure 4

5. Remove air duct (**B, figure 5**) above the glove compartment.



Figure 5

6. Unclip and remove cover (**C, figure 6**) at the instrument panel on top.
i With a sound system, also remove speaker under the cover.



Figure 6

7. Remove center console (**AR68.20-P-2000CW**).
8. Remove automatic climate control and operating unit.

i For basic data of model 204, see **AR83.40-P-6350CW**

i For basic data of model 207, see **AR83.25-P1124EC**

9. Remove trim (**D, figure 7**) around the instrument cluster.

i For basic data of model 204, see **AR54.30-P-6015CW**.

i For basic data of model 207, see **AR54.30-P-6015EZ**.



Figure 7

10. Remove the two bottom threaded connections (**E, figure 8**) of the instrument cluster.

i These screws are simultaneously fasteners for the instrument panel.

i The upper two screws do not need to be removed.



Figure 8

11. Remove four screws (F, figure 9) for fastening the instrument panel



Figure 9

12. Disconnect electrical contacts (G, figure 10) at the front passenger airbag.



Figure 10

13. Remove lock nuts (**H, figure 11**) for the front the passenger airbag.

i Lock nuts should only be replaced if they are damaged. For more info see: **AH00.00-N-0001-01A / Modification notes 27.10.2016**



Figure 11

14. Slightly raise instrument panel at the front passenger side and remove the front passenger airbag in a downwards direction. Take special care not to crack the dashboard material. **DO NOT REMOVE THE DASHBOARD**
15. Use the "Scan VIN" button (**figure 12**) to scan the vehicle identification number either by the barcode or the text field.

i After scanning, compare the vehicle identification number that has been read in the app and correct any scanning errors manually.

i All required data can also be read off and entered manually.

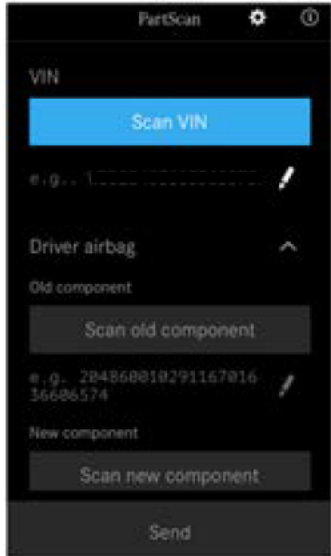

Figure 12

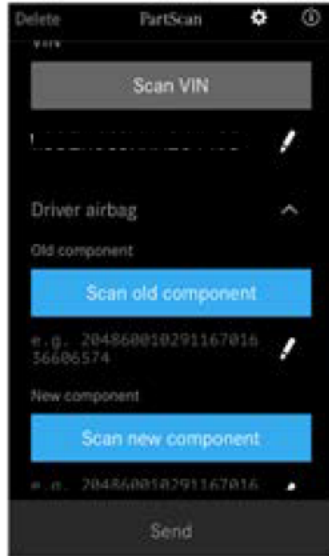

Figure 13

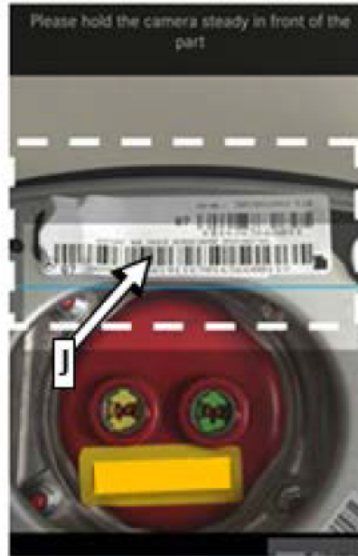





Figure 14

16. Scan barcodes of the removed driver airbag using the button "Scan old component" (figure 13).

-  Ensure that the lower barcode (J, figure 14) is scanned.
-  All required data can also be read off and entered manually.

17. Scan the barcodes of the new driver airbag using the button "Scan new component" (figure 13).

-  Ensure that the lower barcode (J, figure 14) is scanned.
-  All required data can also be read off and entered manually.

18. Repeat operation steps 16 and 17 on the old and new front passenger airbag.

19. Create a scan ID via the "Send" button (figure 15).

-  The generated scan ID (figure 16) must be recorded in writing in the workshop order and then stored in a tamper-proof manner.

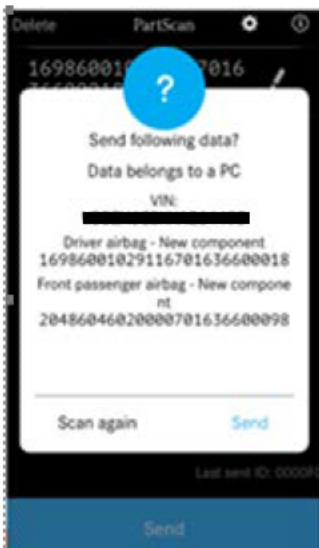

Figure 15

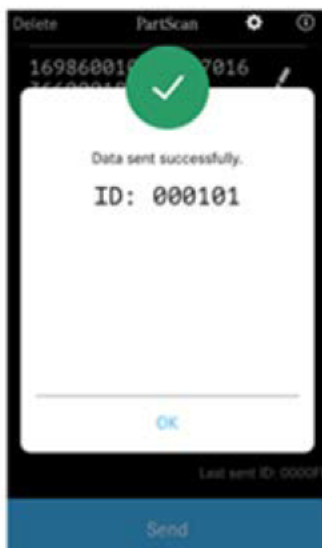



Figure 16

-  For order invoicing, it is **mandatory** to enter the "ID" in the comment field of the **EVA / VEGA** application.

ID: _____

20. Install driver airbag at the steering wheel.

Nm Screw for airbag at steering wheel **8 Nm**.

i Contrary to the work instructions in WIS, it is **not** necessary to check the supplemental restraint system with XENTRY/DAS following driver airbag replacement.

i For basic data for model 204, see **AR91.60-P-0660CW**.

i For basic data of model 207, see **AR91.60-P-0660EW**

i For vehicles with **code 428**, switch up the connector coupling for the steering wheel gearshift button, rework to the new driver airbag (**BT54.18-P-0002-01CW**).

21. Carefully insert the new front passenger airbag from below and fasten to the instrument panel with 4 nuts.

i Contrary to the work instructions in WIS, it is **not** necessary to check the supplemental restraint system with XENTRY/DAS following front passenger airbag replacement.

Nm Nut of front passenger airbag at instrument panel **5 Nm**.

22. Place instrument panel back into position and install the air ducts (**K**, **figure 17**) correctly.

i The air ducts are pulled out when the instrument panel is raised.



Figure 17

23. Assemble in reverse order.

24. Connect ground line to on-board electrical system battery.

25. Turn the transmitter key in the electronic ignition lock to **position 1** and check whether the airbag indicator lamp (**L**, **figure 18 or 19**) correctly switches off after a few seconds.

i The SRS check is thus completely ensured after airbag replacement.

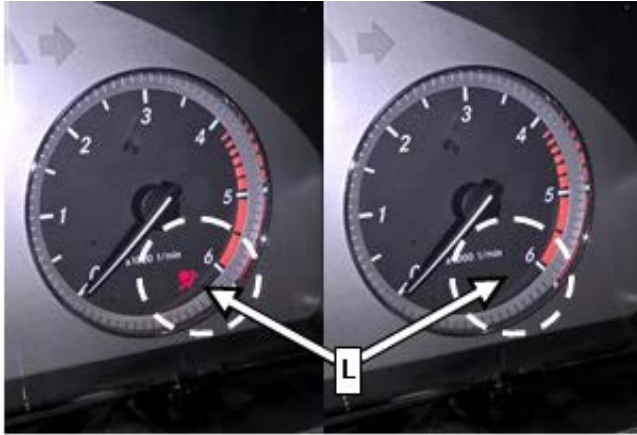

Figure 18

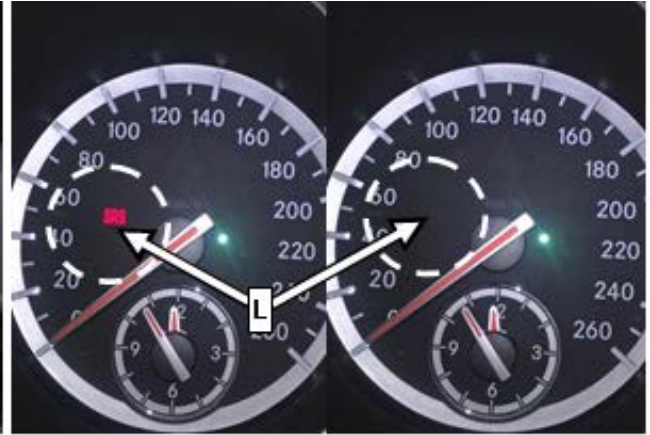

Figure 19

Procedure X204

1. Disconnect ground line from the on-board electrical system battery.
2. Remove driver airbag at the steering wheel.
i For basic data of model X 204, see **AR91.60-P-0660CW**
3. Remove glove compartment housing (**AR68.10-P-1200CY**).
4. Remove air duct (**B, figure 1**) above the glove compartment.

**Figure 1**

5. Disconnect electrical contacts (**G, figure 2**) at the front passenger airbag.

**Figure 2**

6. Remove threaded connections (**H**, figure 3) for the front the passenger airbag.

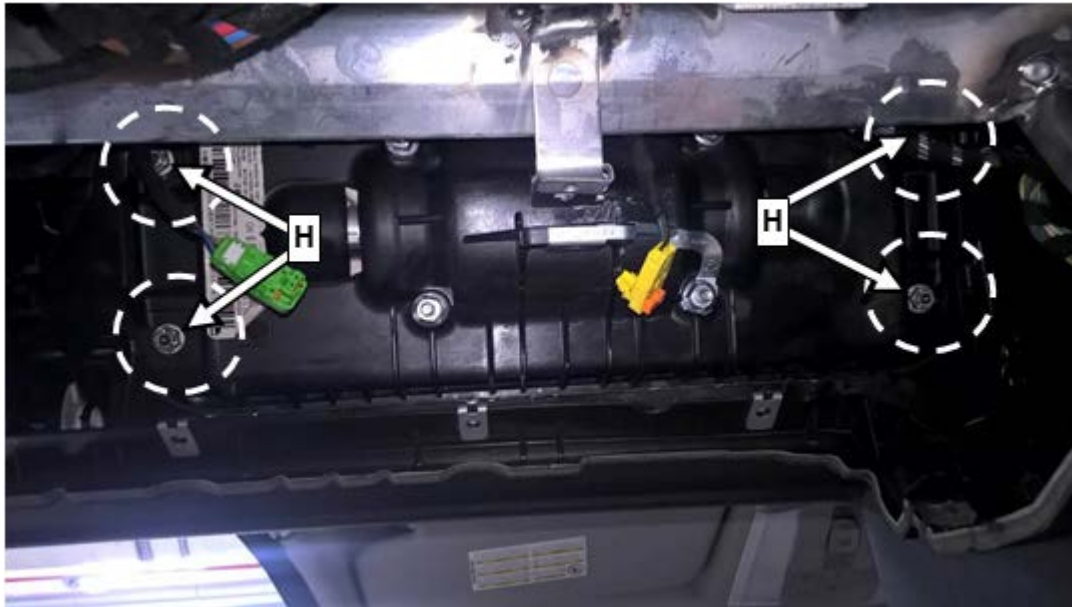

Figure 3

7. Remove Screw (**M**, figure 4) for the front passenger airbag.



Figure 4

8. Remove passenger airbag unit.

i To remove the front passenger airbag, slightly push the bracket (**N**, **figure 5**) forward.



Figure 5

9. Follow the same scanning procedure with the MB PartScan App as described above for type W 204.

10. Install driver airbag at the steering wheel.

i For basic data of model X204, see **AR91.60-P-0660CW**.

11. Install passenger airbag unit.

i Contrary to the work instructions in WIS, it is **not** necessary to check the supplemental restraint system with XENTRY/DAS following front passenger airbag replacement.

Hm Nut of front passenger airbag at instrument panel **5 Nm**.

12. Assemble in reverse order.

13. Connect ground line to on-board electrical system battery.

14. Turn the transmitter key in the electronic ignition lock to **position 1** and check whether the airbag indicator lamp (**L**, **figure 6 or 7**) correctly switches off after a few seconds.

i The SRS check is thus completely ensured after airbag replacement!

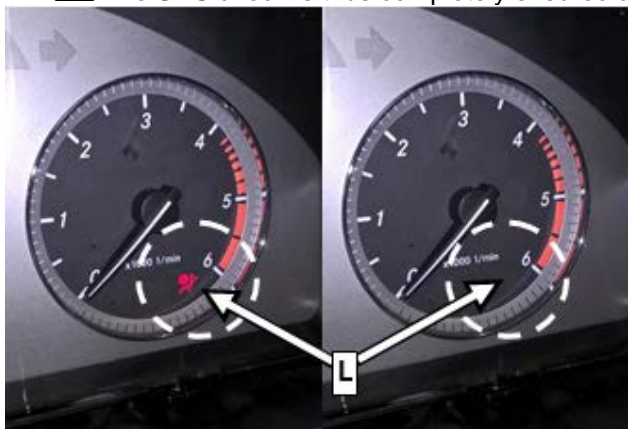

Figure 6

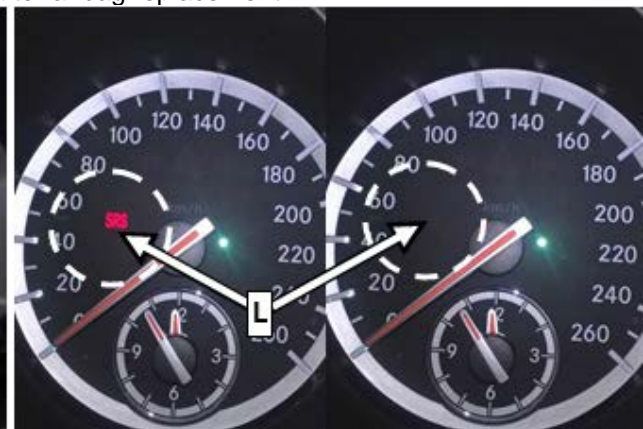

Figure 7

Work procedure**Type 197**

1. Disconnect ground line from the on-board electrical system battery.
2. Remove driver airbag at the steering wheel.
For basic data of model 197, see **AR91.60-P-0660RQ**.
3. Remove passenger airbag unit.
For basic data of model 197, see **AR91.60-P-0680RQ**.
4. Follow the same scanning procedure with the **MB PartScan App** as described above for type 204.
5. Install driver airbag at the steering wheel.
For basic data of model 197, see **AR91.60-P-0660RQ**.
6. Install passenger airbag unit.
For basic data of model 197, see **AR91.60-P-0680RQ**.

i Note:

- Requested parts must be returned in accordance with the warranty parts return requirements section found in the policy and procedures manual.
- Use the attached hazmat shipping document as a guide for shipping airbags.

i Note

(regarding WIS documents referenced in this Procedure):

Replacement of parts not listed in the parts table of this Procedure are not claimable under this campaign. If replacement of additional part(s) is necessary, check coverage prior to submitting under warranty.

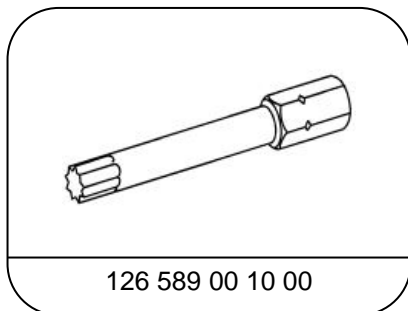
W Special Tools

Screwdriver bit

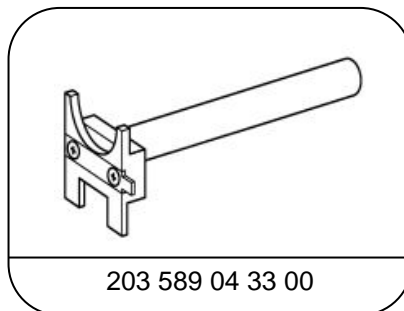

Removal lever

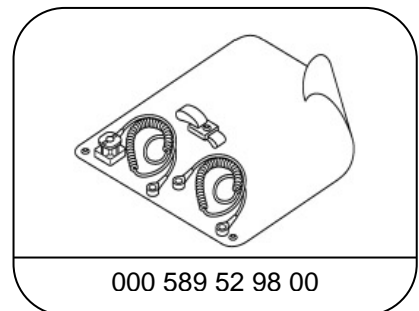

Electro Static Discharge (ESD) kit (or locally sourced equivalent)

Primary Parts Information

Qty.	Part Name	Part Number	Estimated Replacement Rate
As required	Driver's airbag, dull black 197 (3 spoke)	A 000 860 55 02 05 9116	100%
As required	Driver's airbag, dull black W 204 (4 spoke)	A 000 860 56 02 05 9116	100%
As required	Driver's airbag, steppe brown W 204 (4 spoke)	A 000 860 56 02 05 8490	100%
As required	Driver's airbag, dull black W/X 204 (3 spoke)	A 000 860 57 02 05 9116	100%
As required	Driver's airbag, dull black W/X 204 AMG (3 spoke)	A 000 860 58 02 05 9116	100%
As required*	Driver's airbag, flannel gray C 207	A 000 860 59 02 05 7347	100%
As required*	Driver's airbag, dull black C 207	A 000 860 59 02 05 9116	100%
As required*	Driver's airbag, steppe brown C 207	A 000 860 59 02 05 8490	100%
As required	Front passenger airbag C207	A 207 860 03 00 05	100%
As required	Front passenger airbag W/X204	A 204 860 12 00 05	100%
As required	Front passenger airbag 197	A 197 860 00 00 05	100%

* Color code can be determined via XPPI

i Note:

- Please be aware that only the part number(s) referenced in the Campaign Bulletin is/are approved for use to repair the vehicle. Repairs performed using any other part(s) will not have been performed in accordance with the campaign. Accordingly, warranty claims submitted with reference to an improper part number(s) will be denied.
- The following allowable labor operation should be used when submitting a warranty claim for this repair:

Warranty Information

Operation: Replace driver-side airbag and front passenger airbag (02-1525)

Damage Code	Operation Number	Labor Time (hrs.)
91 940 06 7	02-1525 (W 204)	1.4
	02-1525 (X 204)	1.0
	02-1525 (C 207)	1.7
	02-1525 (197)	ZM

(Includes: Disconnecting and connecting ground cable of on-board electrical system battery).

i Note

Operation Number labor times are subject to change.

Attachment A - SRS Light Diagnosis/Repair Process - Takata Airbag Recall Only

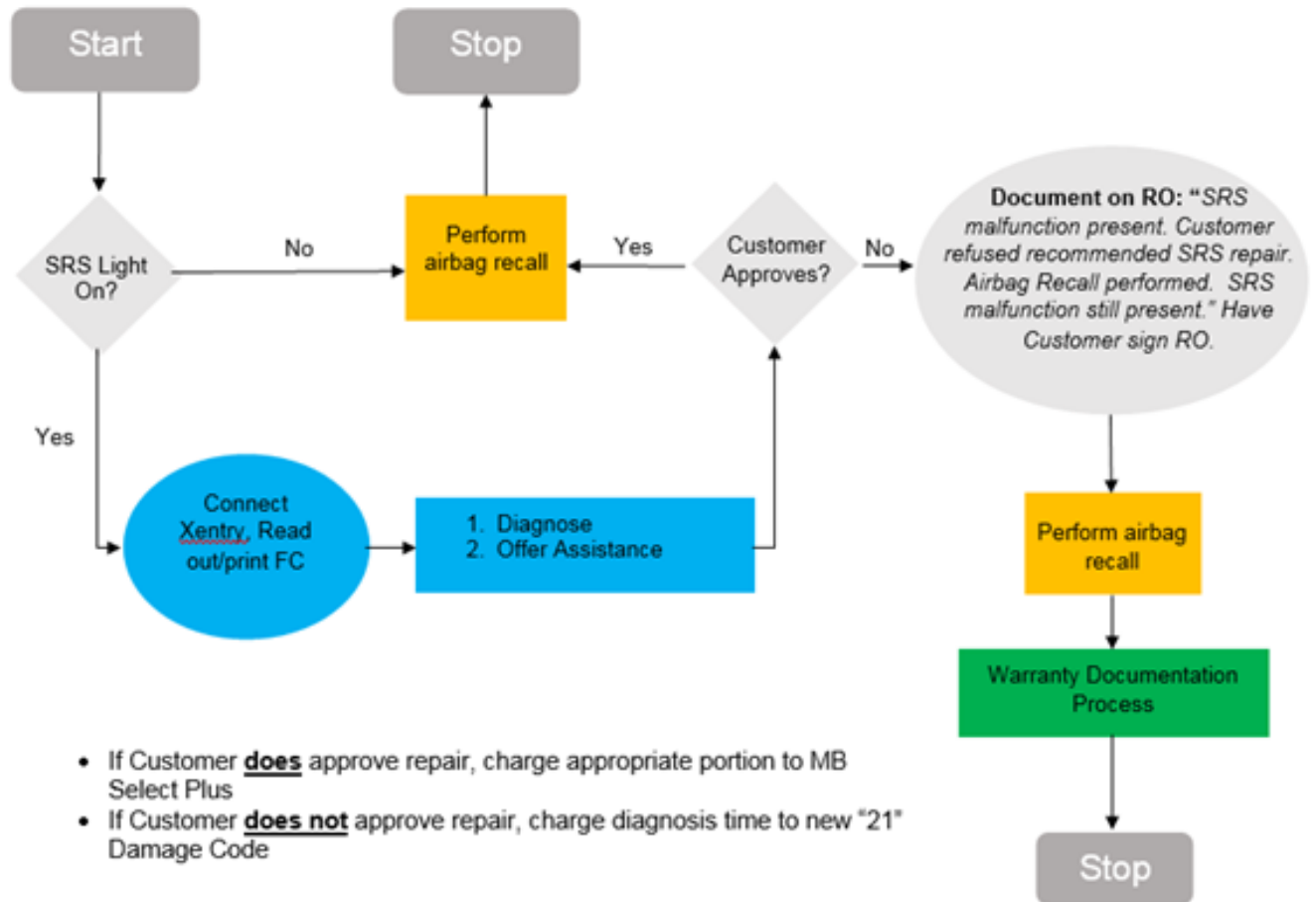

- If Customer **does** approve repair, charge appropriate portion to MB Select Plus
- If Customer **does not** approve repair, charge diagnosis time to new "21" Damage Code

Legend

- Claim against MB-Select Plus
- Claim against Recall
- Claim against new "21" damage code

Warranty Documentation Process

1. Claim against new "21" damage code
 - a) **21664 00 Takata Diagnosis – No Repair**
2. Up to 2 hours diagnostic time permitted
3. Ensure diagnostic time is properly punched on RO
4. Ensure RO is documented properly
5. Attach RO to warranty claim



Mercedes-Benz



Hazardous Materials Shipping Instructions - GROUND

Part Name: Airbag Part Numbers:	Hazardous Properties: Contains initiating component which deploys (inflates) airbag.
------------------------------------	---

STRAIGHT BILL OF LADING ORIGINAL - NOT NEGOTIABLE							
PIECES	IN	HM	DESCRIPTION	WEIGHT	RATE	CHARGES	CLASS
1	box	X	UN3268, Safety devices, 9	Write gross weight of box here			
This is to certify that the above-named materials are properly classified, described, packaged, marked and labeled, and are in proper condition for transportation according to the applicable regulations of the Department of Transportation.							
SHIPPER HazMat Employee Signs				CARRIER Name of Carrier			
EMERGENCY CONTACT: CHEMTREC 1-800-424-9300							

Steps to Return an Airbag:

REQUIRED PACKAGING:

- Carefully open received box and remove new airbag. Keep box intact & save all contents!
- Place used airbag into replacement airbag box, re-using any packaging material (e.g., cardboard inserts) used for the new airbag. Package as the new airbag was packaged.
- Use plastic adhesive tape 50 mm wide to secure the box closed. Do not obscure labels or text on the box with the tape.
- Ensure that the 4G fiberboard box is not ripped or damaged.

REQUIRED LABELS:

- A Class 9 Miscellaneous label must be clearly visible on one side of the box.

REQUIRED PACKAGE MARKINGS:

- The following words ("marking") must also be clearly visible on the same side of the box as the Class 9 label:
Safety devices
UN3268 (font size must be $\geq \frac{1}{2}$ inch)
- Affix "To/From" address label to same or adjacent packaging face as the hazardous markings/labels.
- The UN 4G code preprinted near the bottom edge of the box must also be clearly visible.

DOCUMENTATION:

- Include a HAZMAT bill of lading (see above example) with the package. For returns via DDS or FedEx Ground, the system will generate the Hazmat bill of lading.

COMMENTS:

- **Note:** The Packing Group and the EX# are no longer required to be printed on the HAZMAT bill of lading.
- **Package example:**



Questions? Contact MBUSA Corporate EH&S at (630) 462-3440 or (770) 705-2578

12/5/2016



Mercedes-Benz



Hazardous Materials Shipping Instructions for shipments using an Overpack - GROUND

Part Name: Airbag Part Numbers:	Hazardous Properties: Contains initiating component which deploys (inflates) airbags.
------------------------------------	--

STRAIGHT BILL OF LADING
ORIGINAL - NOT NEGOTIABLE

PIECE	IN	HM	DESCRIPTION	WEIGHT	RATE	CHARGES	CLASS
1 box		X	UN3268, Safety devices, 9 OVERPACK USED	Write gross weight of box here			

This is to certify that the above-named materials are properly classified, described, packaged, marked and labeled, and are in proper condition for transportation according to the applicable regulations of the Department of Transportation.

SHIPPER HazMat Employee Signs	CARRIER Name of Carrier
EMERGENCY CONTACT: CHEMTREC 1-800-424-9300	

Steps to Return Multiple Airbags in 1 Box:

REQUIRED PACKAGING:

- Carefully open received UN spec box and remove new airbag. Keep the box intact & save all contents!
- Place used airbag back into replacement airbag box, re-using any packaging material (e.g., cardboard inserts) used for the new airbag. Package as the new airbag was packaged.
- Use plastic adhesive packaging tape 50 mm wide to secure box closed. Do not obscure labels or text on box with tape.

REQUIRED LABELS:

- A Class 9 Miscellaneous label must be clearly visible on one side of the box.

REQUIRED PACKAGE MARKINGS:

- The following words ("markings") must also be clearly visible on the same side of the box as the label:
Safety devices
UN3268 (font size must be $\geq \frac{1}{2}$ inch)
- Affix "To/From" address label to same or adjacent packaging face as the hazardous markings/labels.
- The UN 4G code preprinted near the bottom edge of the box must also be clearly visible.

OVERPACKS (more than 1 airbag sent as 1 shipment):

- Package each airbag in a separate UN spec box prepared with the labels/markings described above.
- Place each individual airbag box inside a larger non-UN spec box to keep the shipment together.
- This larger box is called an "OVERPACK."

- The OVERPACK must have the identical markings and label as the boxes contained inside.
- The OVERPACK must have the "OVERPACK" statement on the same face as the hazard markings and labels. **Package example:**

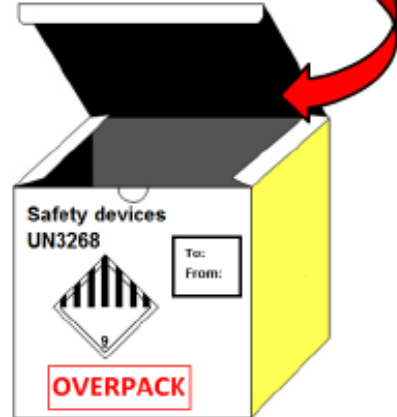
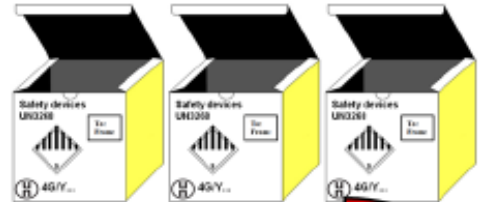

Questions? Contact MBUSA Corporate EH&S at (630) 462-3440 or (770) 705-2578

12/5/2016