

# **TECHNICAL INSTRUCTIONS**

**FOR**

**SAFETY RECALL JLL**

**PASSENGER AIRBAGS COULD DEACTIVATE**

**CERTAIN 2008 – 2019 LX 570**

The repair quality of covered vehicles is extremely important to Lexus. All dealership technicians performing this recall are required to successfully complete the most current version of the E-Learning course “Safety Recall and Service Campaign Essentials”. To ensure that all vehicles have the repair performed correctly; technicians performing this recall repair are required to currently hold at least one of the following certification levels:

- Certified
- Senior
- Master

It is the dealership’s responsibility to select technicians with the above certification level or greater to perform this recall repair. Carefully review your resources, the technician skill level, and ability before assigning technicians to this repair. It is important to consider technician days off and vacation schedules to ensure there are properly trained technicians available to perform this repair at all times.

## I. OPERATION FLOW CHART

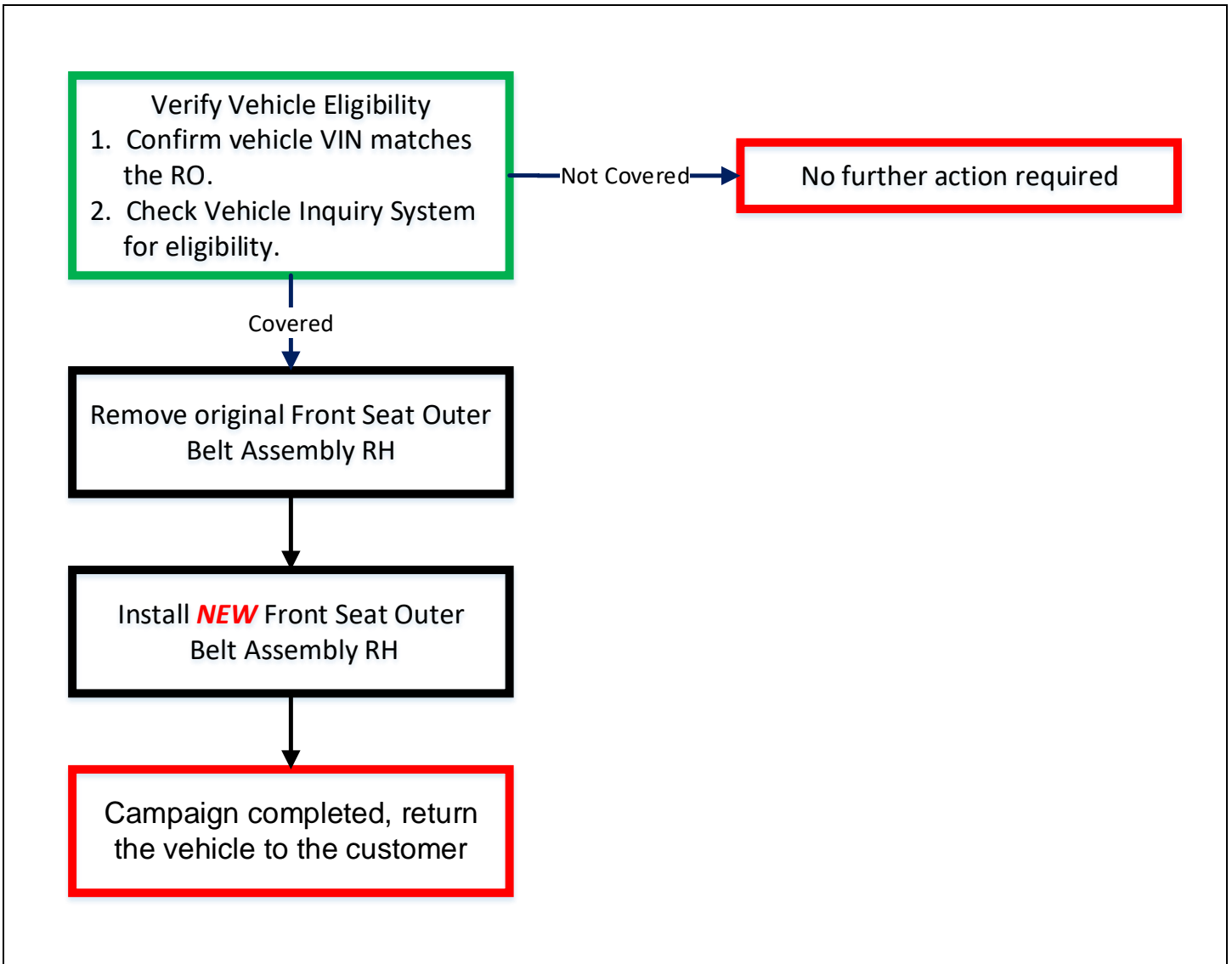

## II. IDENTIFICATION OF AFFECTED VEHICLES

1. CHECK VEHICLE FOR CAMPAIGN ELIGIBILITY
  - a. Compare the vehicles VIN to the VIN listed on the Repair Order to ensure they match.
  - b. Check the TIS Vehicle Inquiry System to confirm the VIN is involved in this Campaign, and that it has not already been completed.

Note: TMNA warranty will not reimburse dealers for repairs completed on vehicles that are not affected or were previously completed, even by another dealer.

### III. PREPARATION

#### A. PARTS

To determine the correct Campaign Part Number, use the vehicles VIN number to look up the correct Service Part Number. Using the following chart to determine the correct Campaign Part Number from the Service Part Number. **DO NOT ORDER THE SERVICE PART.** Only order the Campaign Part Number. Warranty will only accept claims for Campaign Part Numbers.

Model Year	Color / Description	Service Part Numbers	Campaign Part Number
2008-2011	IVORY	73210-60670-A0	04008-71160
		73210-60670-A1	
		73210-60671-A1	
		73210-60A40-A0	
	LT. GRAY/BLACK	73210-60670-B0	04008-71260
		73210-60670-B1	
		73210-60671-B2	
		73210-60A40-B0	
	IVORY	73210-60680-A0	04008-71460
		73210-60680-A1	
		73210-60681-A1	
		73210-60A50-A0	
	LT. GRAY/BLACK	73210-60680-B0	04008-71560
		73210-60680-B1	
		73210-60681-B2	
		73210-60A50-B0	
2013-2015	BLACK	73210-60650-B0	04008-71760
		73210-60A60-B0	
	IVORY/IVORY	73210-60650-A2	04008-71960
		73210-60651-A4	
	BLACK	73210-60A70-A1	04008-72160
		73210-60651-C0	
	BLACK	73210-60A70-C0	04008-72260
		73210-60850-B0	
	IVORY/IVORY	73210-60A80-B0	04008-72460
		73210-60850-A2	
		73210-60851-A4	
	BLACK	73210-60A90-A1	04008-72560
		73210-60851-C0	
		73210-60A90-C0	

(cont. on next page)

Model Year	Color / Description	Service Part Numbers	Campaign Part Number
2016-2019	IVORY	73210-60860-A0	04008-72760
		73210-60861-A0	
		73210-60862-A0	
	BLACK	73210-60860-C0	04008-72860
		73210-60861-C0	
		73210-60862-C0	

## B. TOOLS & EQUIPMENT

- Techstream
- Standard Hand Tools
- Torque Wrench

## IV. BACKGROUND

The front passenger occupant classification system has a seatbelt tension sensor that could malfunction over time and could cause the airbag warning light and the passenger airbag “OFF” indicator to illuminate. In addition, the front passenger airbag, knee airbag, and the passenger seat-mounted side airbag may be deactivated. If these airbags are deactivated, there is an increased risk of injury to the occupant in the event of a crash.

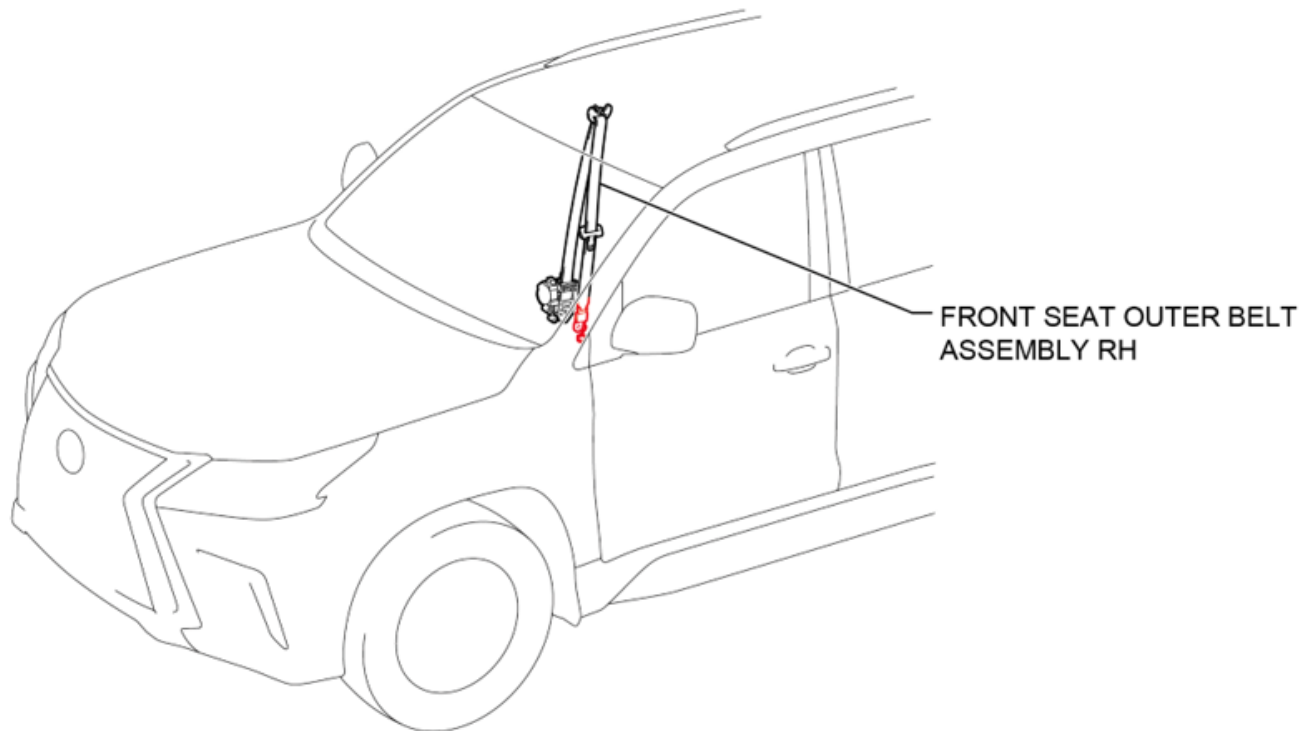

## V. COMPONENTS

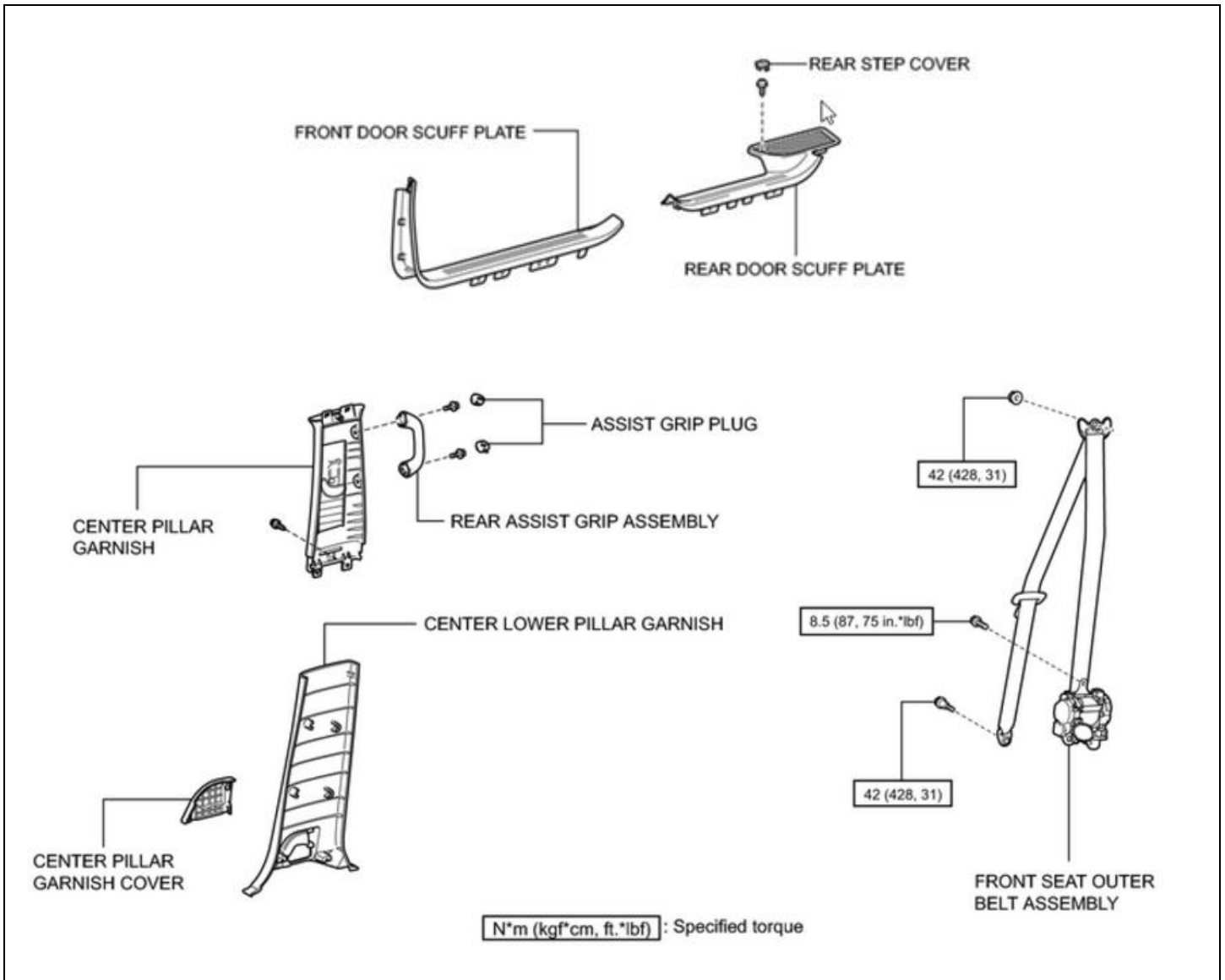

## VI. DISASSEMBLY



### 1. CHECK FOR DTC'S

- Using a Techstream, check for Diagnostic Trouble Codes.

**Note:** *This Safety Recall covers only the replacement of the Front Seat Outer Belt Assembly RH, as detailed in these instructions. It does not cover the diagnosis or replacement of any other parts on the vehicle.*

### 2. DISCONNECT NEGATIVE BATTERY CABLE

- Slide the RH front seat to the forward most position.
- Tilt the RH front seat seatback to the forward most position.
- Disconnect the negative terminal of the 12v battery.
- Wait at least 90 seconds after disconnecting the negative battery cable before proceeding.

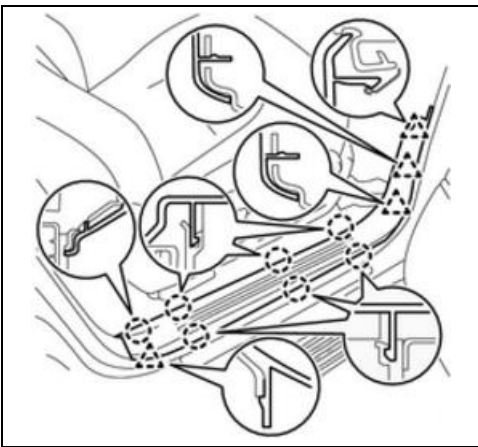

### 3. REMOVE FRONT SCUFF PLATE RH

- Detach the 7 claws and 4 clips.
- Disconnect the electrical connector for the illumination circuit, if equipped.

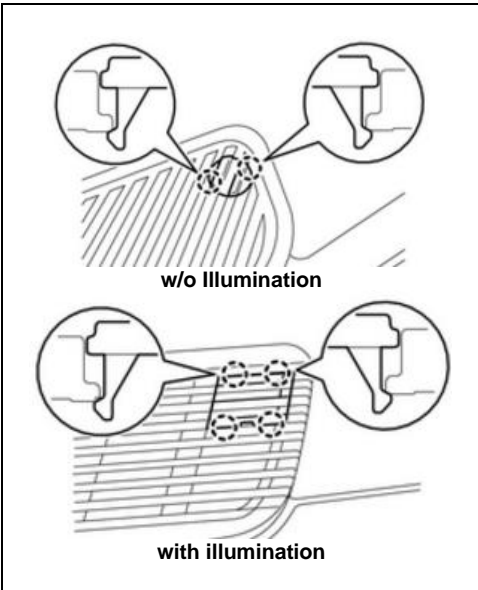

### 4. REMOVE REAR SCUFF PLATE RH

- Remove the access cover on the step by disengaging the claws.

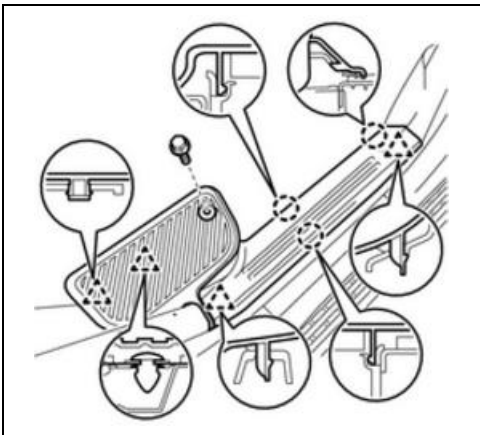

- b. Remove the screw.
- c. Detach the 3 claws and 4 clips.
- d. Disconnect the electrical connector for the illumination circuit, if equipped.

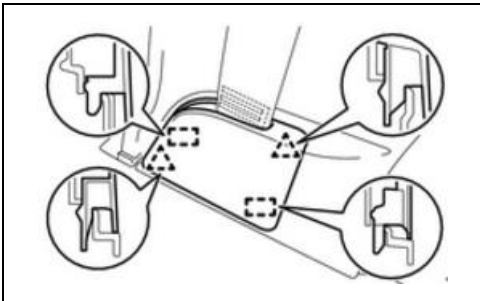

**5. REMOVE LOWER CENTER PILLAR GARNISH RH**

- a. Detach the 2 clips and 2 guides to remove the cover at the base of the Center Pillar Garnish.

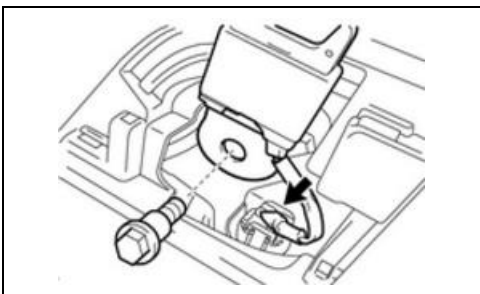

- b. Remove the bolt from the seat belt anchor.
- c. Disconnect the connector.

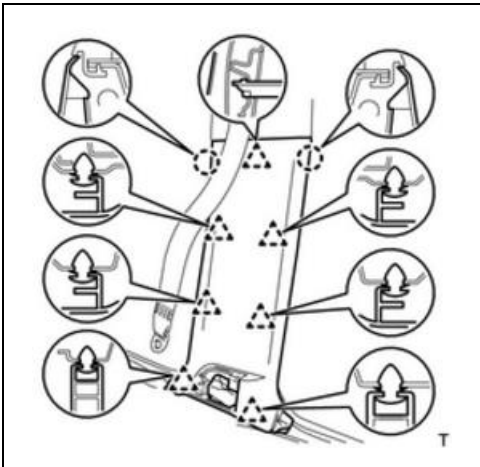

- d. Detach the 2 claws and 7 clips.

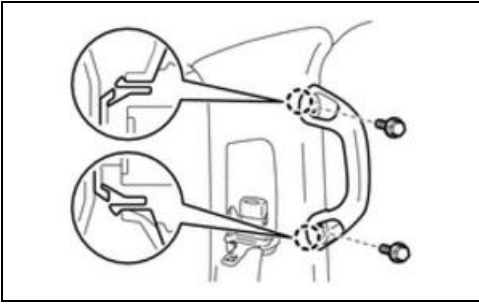

**6. REMOVE REAR ASSIST GRIP RH**

- a. Detach the 4 claws to remove the 2 assist grip plugs.
- b. Remove the 2 bolts.
- c. Detach the 2 claws and remove the rear assist grip.

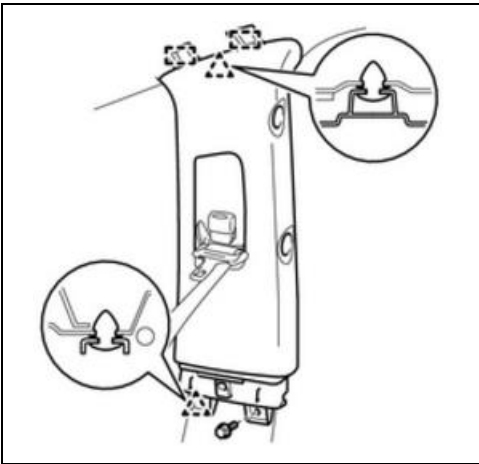

**7. REMOVE UPPER CENTER PILLAR GARNISH RH**

- a. Remove the bolt
- b. Detach the 2 clips and 2 guides.
- c. Pass the seat belt anchor through the Center Pillar Garnish.

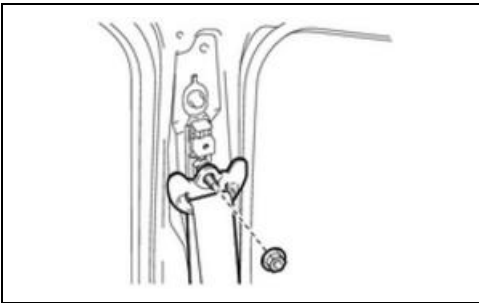

**8. REMOVE FRONT SEAT OUTER BELT RH**

- a. Remove the nut and shoulder anchor.

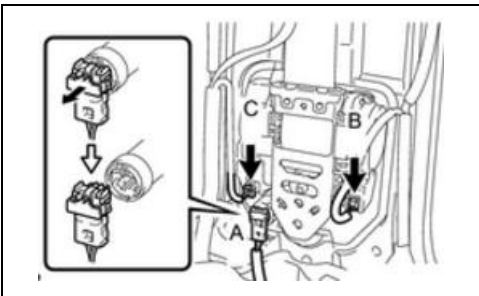

- b. Disconnect the pretensioner connector (A)
- c. Disconnect the tension reducer connector (B)
- d. Disconnect the pre-collision connector (C) if equipped.

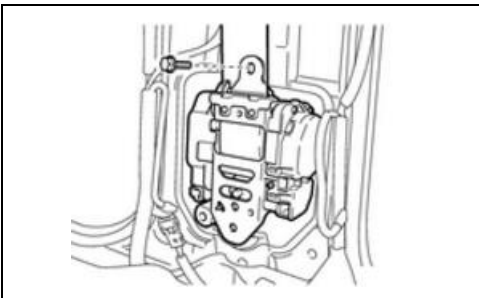

- e. Remove the bolt.



## VII. REASSEMBLY

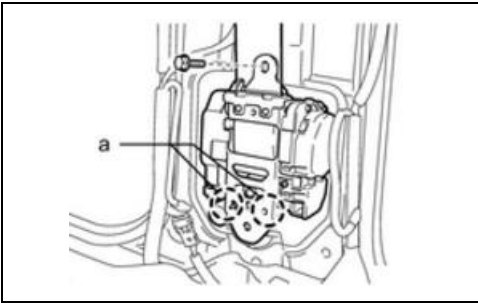

1. **INSTALL NEW FRONT SEAT OUTER BELT RH**
  - a. Align the claws (a) of the vehicle with the **NEW** Front Seat Outer Belt positioning holes.
  - b. Install the bolt.

**Torque: 8.5N·m {87 kgf·cm, 75 in.lbs}**

**Note: When installing the retractor, make sure the claws of the vehicle (a) only contact the installation areas of the retractor.**

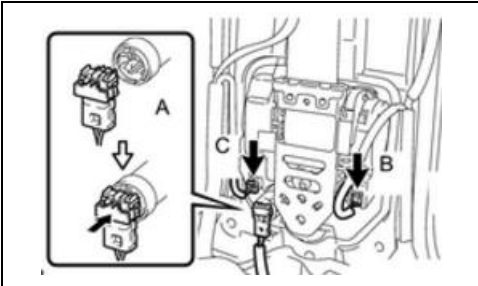

- c. Connect the pretensioner (A) connector.
- d. Connect the tension reducer (B) connector.
- e. Connect the pre-collision connector (C) if equipped.

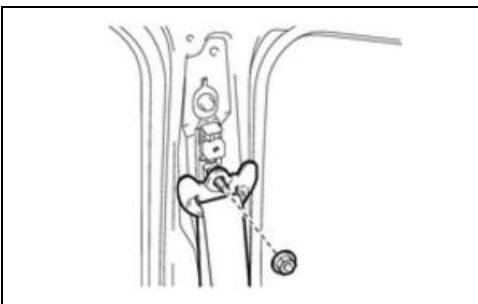

- f. Install the shoulder anchor to the shoulder belt with the nut.

**Torque: 42 N·m {428 kgf·cm, 31 ft.lbs}**

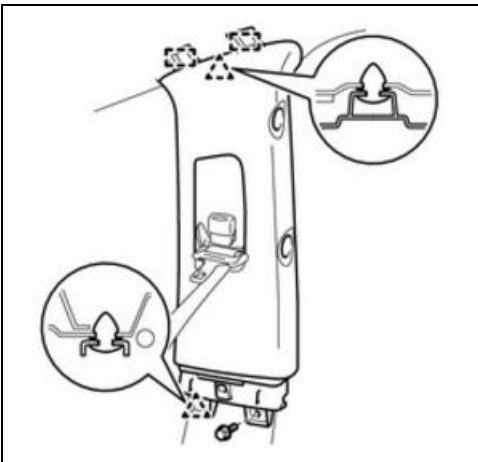

2. **INSTALL UPPER CENTER PILLAR GARNISH RH**
  - a. Pass the seat belt anchor through the Center Pillar Garnish.
  - b. Attach the 2 clips and 2 guides.
  - c. Install the bolt.

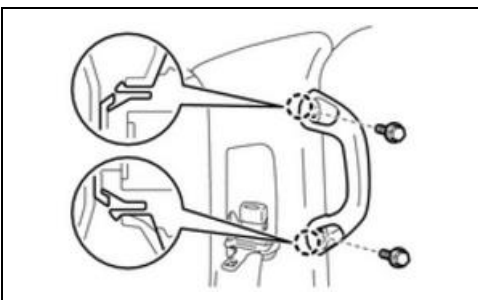

3. **INSTALL REAR ASSIST GRIP RH**
  - a. Attach the 4 claws to attach the 2 assist grip plugs.
  - b. Install the 2 bolts.
  - c. Attach the 4 claws to install the 2 assist grip plugs.

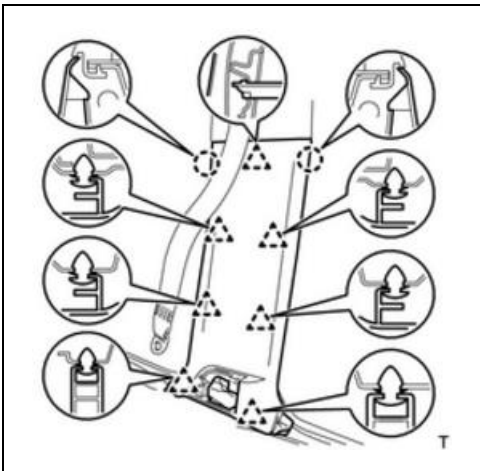

#### 4. INSTALL LOWER CENTER PILLAR GARNISH RH

a. Attach the 2 claws and 7 clips.

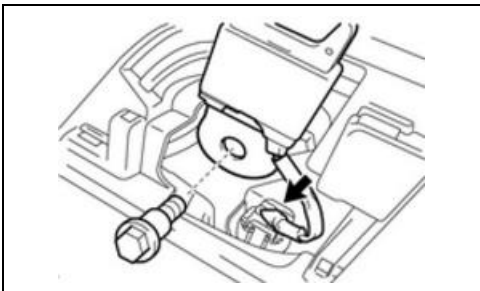

b. Connect the electrical connector.

c. Install the bolt for the seat belt anchor.

**Torque: 42 N·m {428kgf·cm, 31 ft.lbs}**

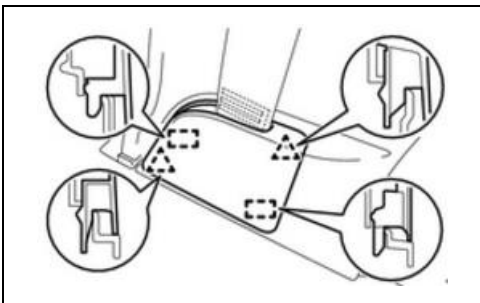

d. Install the 2 clips and 2 guides for the cover at the base of the Center Pillar Garnish.

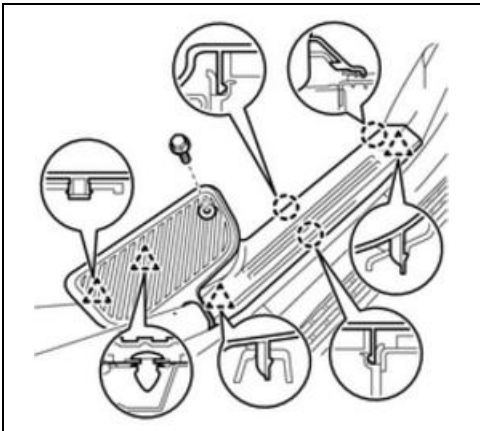

#### 5. INSTALL REAR SCUFF PLATE RH

a. Connect the electrical connector for the illumination circuit, if equipped.

b. Attach the 3 claws and 4 clips.

c. Install the screw.

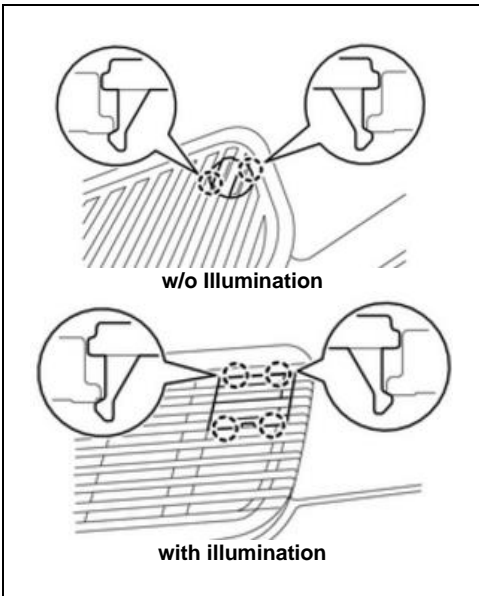

- d. Attach the access cover on the step by engaging the claws.

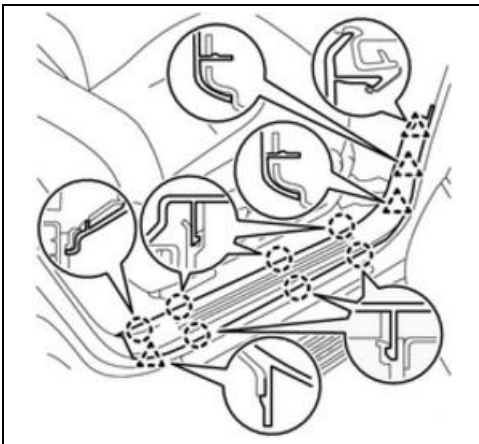

**6. INSTALL FRONT SCUFF PLATE RH**

- a. Connect the electrical connector for the illumination circuit, if equipped.
- b. Engage the 7 claws and 4 clips.

**7. CONNECT NEGATIVE BATTERY CABLE**

- a. Connect the negative battery cable.

**Torque: 5.4 N·m {55 kgf·cm, 48 in.lbs.}**

- b. Return the RH front seat to its normal position.



**8. PERFORM VERIFICATION HEALTH CHECK**

- a. Using a Techstream, perform a Health Check.
- b. Clear DTC's that may be present.
- c. **Re-run the Health Check to confirm that no DTC's reappear.**

## ◀ VERIFY REPAIR QUALITY ▶

- Confirm that the seatbelt retractor operates smoothly.
- Confirm that all interior trim is properly installed.
- Confirm that no DTC's are present.

If you have any questions regarding this update, please contact your area representative.

### 10. APPENDIX

#### A. PARTS DISPOSAL

As required by Federal Regulations, please make sure all recalled parts (original parts) removed from the vehicle are disposed of in a manner in which they will not be reused, ***unless requested for parts recovery return.***

#### B. CAMPAIGN DESIGNATION DECORDER

