

TECHNICAL INSTRUCTIONS
FOR
SAFETY RECALL J0A, J0B, J0C
FRONT PASSENGER AIRBAG “MODULE” REPLACEMENT ONLY



CERTAIN 2005 – 2008 MODEL YEAR MATRIX

All dealership technicians performing this recall are required to successfully complete the most current version of the E-Learning course “Safety Recall and Service Campaign Essentials”. To ensure that all vehicles have the repair performed correctly; technicians performing this recall repair are required to have successfully completed E-Learning course SC18A (if you had previously completed E-Learning Course SC13B, you do not have to take SC18A), in addition to “Safety Recall and Service Campaign Essentials”, and currently hold at least one of the following certifications levels:

- Toyota Certified (Electrical)
- Toyota Expert (Any Specialty)
- Master
- Master Diagnostic Technicians

It is the dealership’s responsibility to select technicians with the above certification level or greater to perform this repair. Carefully review your resources, the technician skill level, and ability before assigning technicians to this repair. It is important to consider technician days off and vacation schedules to ensure there are properly trained technicians available to perform this repair at all times.

I. OPERATION FLOW CHART

The flow chart is for reference only. **DO NOT** use it in place of the full technical instructions. Follow **ALL** steps as outlined in the full technical instructions to confirm the campaign is completed correctly.

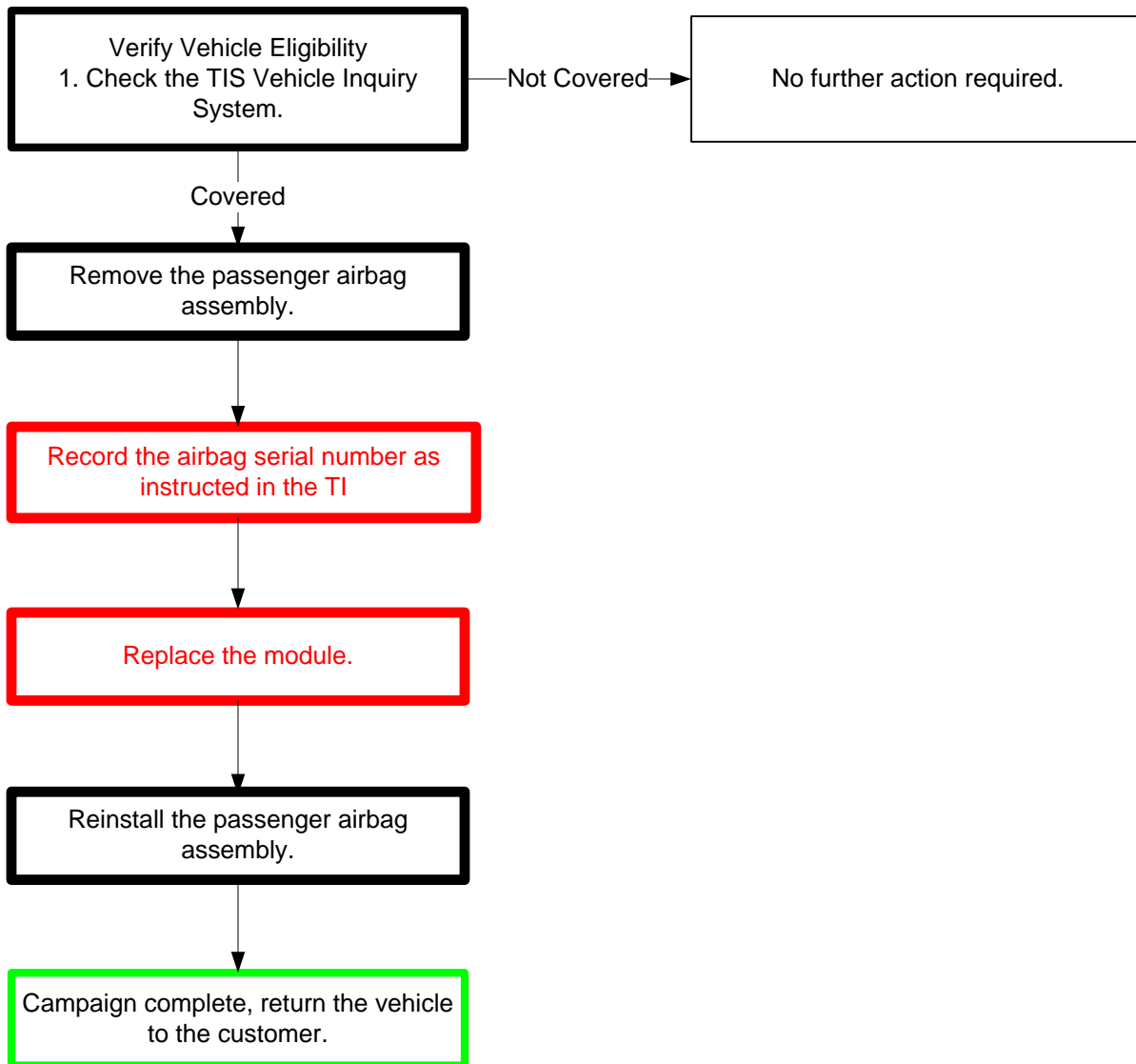

II. BACKGROUND

The subject vehicles are equipped with front passenger airbag inflators which may have been manufactured in such a way as to have a potential for the intrusion of moisture over time. Depending on the circumstances, this could create excessive internal pressure when the airbag is deployed and cause the inflator to rupture. In the event of an inflator rupture, metal fragments could pass through the airbag cushion material, striking the vehicle occupants and potentially resulting in serious injury or death.

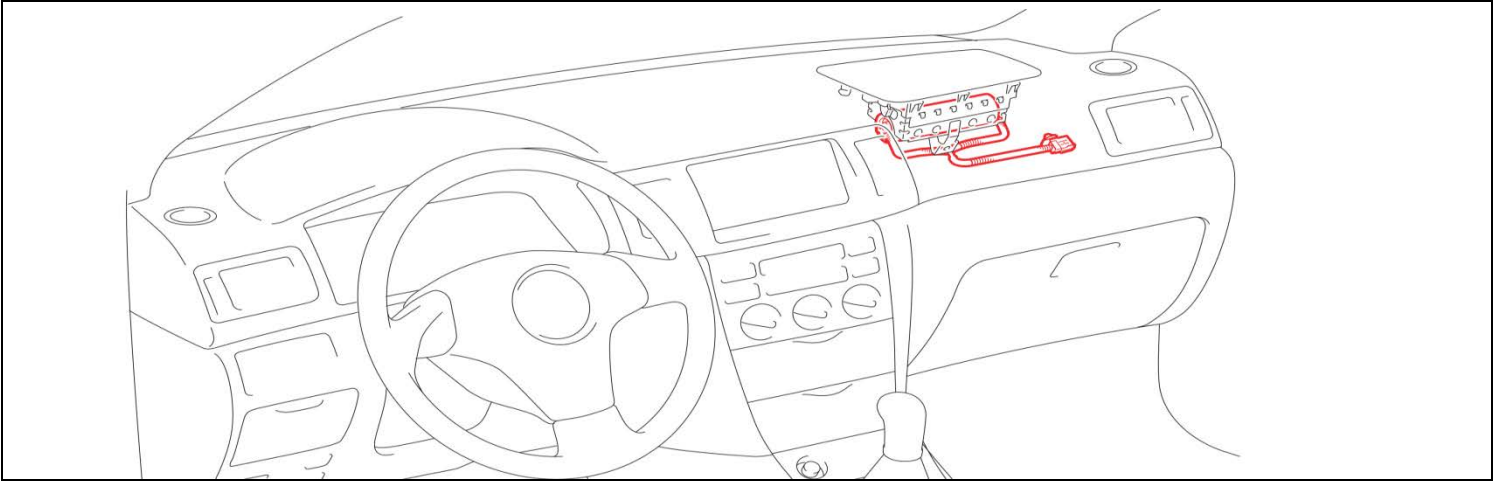

III. IDENTIFICATION OF AFFECTED VEHICLES

- Check the TIS Vehicle Inquiry System to confirm the VIN is involved in this Safety Recall, and that the campaign has not already been completed prior to dealer shipment or by another dealer.
- **TMS warranty will not reimburse dealers for repairs conducted on vehicles that are not affected or were completed by another dealer.**

IV. PREPARATION

A. PARTS

Applicable for: The Continental U.S. 48 States Only

Model	Part Number	Part Description	Quantity
05-08 Matrix	04005-22901	Instrument Panel Airbag Kit*	1
*The kit above includes the following parts.			
		Airbag Module	1
Matrix	04005-28112	IP Wire Harness Kit*	1
*The kit above includes the following parts.			
		Wire Harness	1

Applicable for: Alaska, Hawaii and USTT Locations Only

Model	Part Number	Part Description	Quantity
05-08 Matrix	04005-22801	Instrument Panel Airbag Kit*	1
*The kit above includes the following parts.			
		Airbag Module	1
Matrix	04005-28112	IP Wire Harness Kit*	1
*The kit above includes the following parts.			
		Wire Harness	1

Dealers should discontinue the installation of the parts listed below for the recalls, customer pay repairs AND over-the-counter sales (if applicable) unless they have a mark on the label.



Make sure the parts box has a check mark as seen in the image above

B. TOOLS & EQUIPMENT

- Standard hand tools
- Torque wrench
- Molding remover set
- Techstream

OPTIONAL SST – This is an essential special service tool that the dealership should have. This tool is not mandatory when performing this repair.

Part Number	Part Name	Quantity
09890-47010-01	Anti-Static Mat Set	1

DSF CAMPAIGN TOOLS – This tool was provided to the dealership for campaign D0F and will be used for campaign DSF. This tool is required when performing this repair.

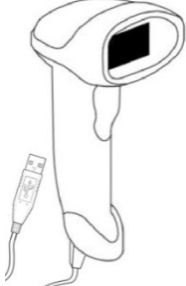
Image	Name	Quantity
	Barcode Scanner	1

NOTE: This tool **CANNOT** be ordered through the parts or tools system. There is a very limited supply of tools, but if additional tools are needed, contact your regional representative.

V. COMPONENTS

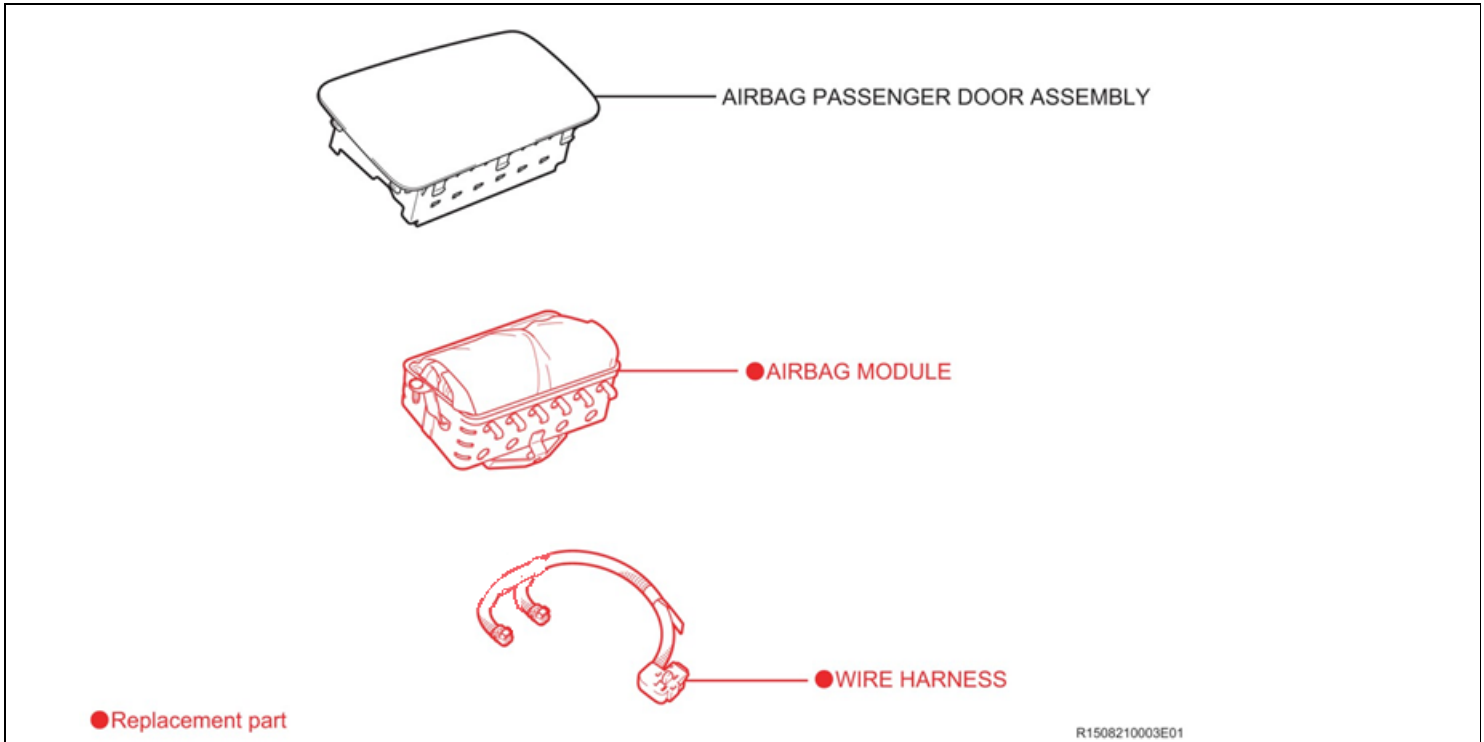

VI. SAFETY PRECAUTIONS



CRITICAL INFORMATION – READ THOROUGHLY



Failure to follow these procedures correctly could cause the SRS to unexpectedly deploy during servicing or the SRS may fail to operate correctly when required after reassembly. Confirm all work is performed as described in these instructions.

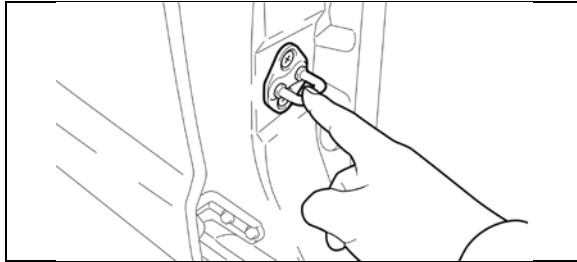

1. ELIMINATE STATIC ELECTRICITY

- a) Before starting work and periodically while working on the vehicle, touch a metallic part of the vehicle to discharge static electricity in the body.

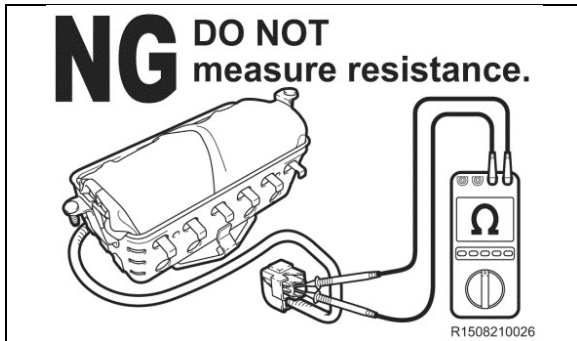

2. DO NOT MEASURE RESISTANCE

- a) **DO NOT** measure resistance of airbag components, this may cause accidental activation.

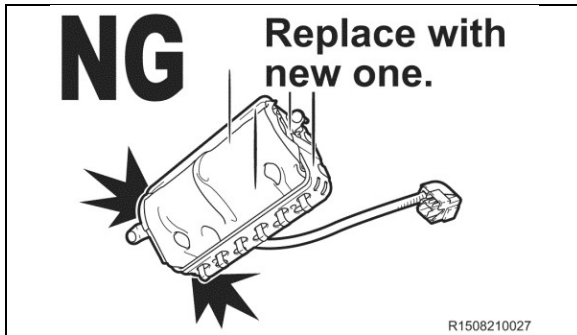

3. HANDLE THE AIRBAG CAREFULLY

- a) If an inflator is dropped, replace it with a **NEW** inflator.

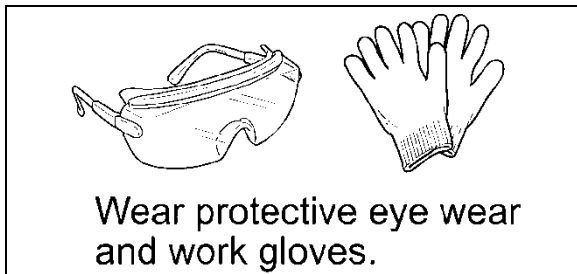

4. WEAR PROTECTIVE EQUIPMENT

- a) Always wear appropriate protective equipment when working on the SRS.

VII. SRS SYSTEM HEALTH CHECK

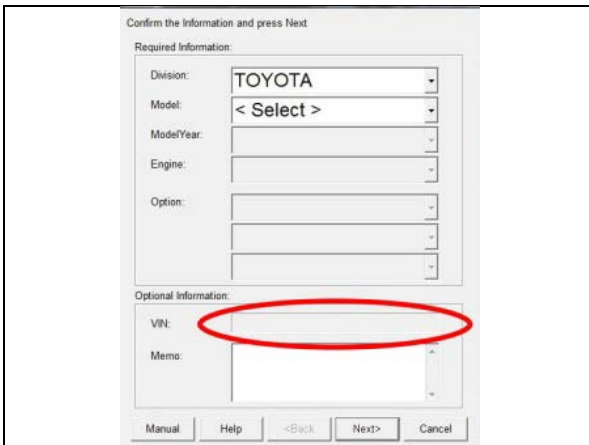

Confirm the information and press Next

Required Information:

Division: TOYOTA

Model: < Select >

ModelYear:

Engine:

Option:

Optional Information:

VIN:

Memo:

Manual Help <Back> Next> Cancel

1. PERFORM A HEALTH CHECK

- Confirm the Techstream is connected to the dealership's internet.
- When launching the Techstream software the VIN **MUST** be entered manually.

NOTE: All letters of the VIN *MUST* be entered in ALL CAPS, or the VIN will need to be reentered when running the diagnostic report.

- Perform a health check.



- The VIN **MUST** be entered manually in ALL CAPS when launching the Techstream software, the VIN **MAY NOT** auto-populate due to vehicle age.
- The serial number recording application will be disabled and the repair cannot be completed if a health check and diagnostic report is not performed and recorded by TMS.

VIII. WORK AREA PREPARATION



CRITICAL INFORMATION – READ THOROUGHLY



The anti-static mat set that is an essential SST may be available at your dealership and is optional to use during inflator replacement. If the anti-static kit is not available, before starting work and periodically while working on the vehicle, touch a metallic part of the vehicle to discharge static electricity in the body.

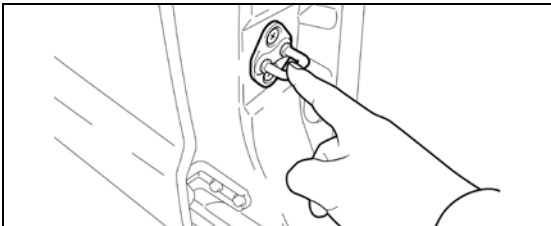

If the anti-static kit is not available, before starting work and periodically while working on the vehicle, touch a metallic part of the vehicle to discharge static electricity in the body.

IX. PASSENGER AIRBAG INFLATOR REPLACEMENT

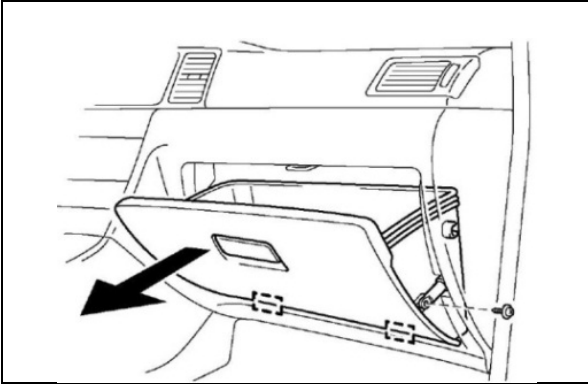

1. REMOVE THE GLOVE BOX

- a) Open the glove box door.
- b) Press in on both sides of the door and swing it down to remove it from the vehicle.

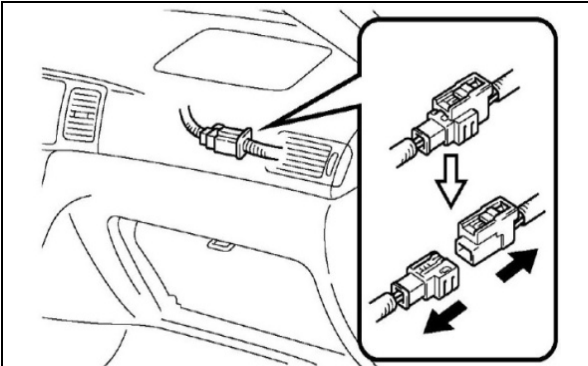

2. REMOVE THE AIRBAG ASSEMBLY

- a) Disconnect the negative battery cable.



- Wait at least 90 seconds after disconnecting the cable from the negative battery terminal to prevent airbag and seat belt pre-tensioner deployment.
- Follow all precautions as outlined on TIS before servicing the SRS system.

- b) Disconnect the airbag connector.
- c) Remove the 2 nuts and release the 6 clips.
- d) Remove the airbag assembly.

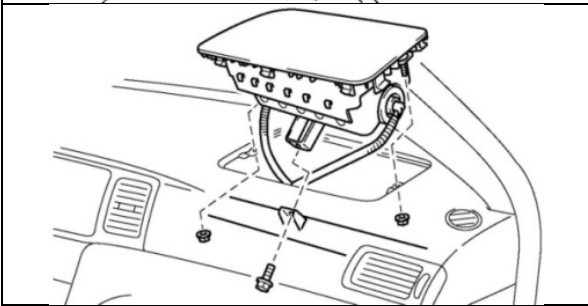

3. CONNECT THE BARCODE SCANNER

- a) Connect the barcode scanner to the USB port on the Techstream.
- b) The scanner will automatically connect and a beep will be heard when the scanner is ready.

NOTE:

- The scanner was provided for SSC D0F.
- The scanner works best in low light conditions.
- Always hold the scanner directly in front of and parallel to the barcode label.

Campaign Phase Interpretation

REMEDY PHASE – ELIGIBLE FOR REPAIR

Campaign Description: Safety Recall J0A - Remedy Notice - Multiple Models - Non-Desiccated Front Passenger Airbag Inflator – “Like for Like” Replacement (Zone A)
Campaign Status: Remedy Available
Completion Status: Not Completed
Memo: Remedy Available

[Show Documents]

STATUS IDENTIFICATION

A: Campaign Status: Remedy Available

B: Memo: Remedy Available

- **This vehicle is eligible to have the remedy performed if the completion status is “Not Completed.”**
- **The original scanning application link can be used.**

Campaign Description: Safety Recall J0A - Remedy Notice - Certain 2003 - 2005 Corolla - Non-Desiccated Front Passenger Airbag Inflator – “Like for Like” Replacement (Zone A)

Campaign Status: Remedy Available

Completion Status: Not Completed

Memo: Remedy Available - Instead of using the scanning application use <https://takata-scan-app.imagespm.info/>

[Show Documents]

STATUS IDENTIFICATION

A: Campaign Status: Remedy Available

B: Memo: Remedy Available – Instead of using the scanning application use <https://takata-scan-app.imagespm.info/>

- **This vehicle is eligible to have the remedy performed if the completion status is “Not Completed.”**
- **The new scanning application website <https://takata-scan-app.imagespm.info/> must be used when performing the remedy.**
- **Login instructions for this new scanning application website are included in the Technical Instructions.**

4. LAUNCH THE SERIAL NUMBER RECORDING APPLICATION



- The ORIGINAL AIRBAG ASSEMBLY, and NEW ASSEMBLY serial numbers MUST be recorded using the barcode scanner.
- The barcode scanner application MUST be completed on every vehicle. These numbers MUST be included on every warranty claim that is submitted for inflator module replacement or the claim may be subject to debit.
- The technician performing the work MUST have an internet connection to perform the inspection and scanning process.

- a) Log into the website via the URL below
<https://takata-scan-app.imagespm.info/>
- b) **User ID:** Dealer Code
First time login password: xxxxx

Login

Complete all required (*) fields below.

* User ID (enter your 5-digit dealer code, or 6-digit for Canadian dealers eg. Cnnnnn format):

* Password:

Login

[Forgot Password?](#)

Enter or Scan VIN

Enter the 17-digit Vehicle Identification Number to begin the search for this campaign.



VIN:

Search

- c) Enter the VIN into the website

5. SCAN THE AIRBAG ASSEMBLY SERIAL NUMBER

ATTENTION: This information is **CRITICAL**

<p>a) Scan the AIRBAG ASSEMBLY serial number 2 times.</p> <ol style="list-style-type: none">1) Confirm the cursor is in the first serial number box then scan the serial.2) Position the cursor in the second serial number box then scan the serial. <p>b) Click search.</p> <p>NOTE:</p> <ul style="list-style-type: none">• If both serial numbers that are entered do not match, confirm and reenter.• If the serial number barcode will not scan, it can be entered manually.	<table border="1"><thead><tr><th data-bbox="841 254 1557 310">AIRBAG SERIAL NUMBER IDENTIFICATION</th></tr></thead><tbody><tr><td data-bbox="841 310 1557 474"><ul style="list-style-type: none">• The airbag serial number is ALWAYS the 12 DIGITS located BETWEEN the asterisks.• The 3 digits before the asterisk ARE NOT part of the serial number, and SHOULD NOT be entered or an inaccurate response may be returned.</td></tr><tr><td data-bbox="841 474 1557 663"><p data-bbox="954 474 1442 506">Airbag Serial Number Label Example</p><div data-bbox="878 520 1520 663"><p>The image shows a label with a barcode and the text 'F22 *000000000XX0*'. A green box highlights the 12-digit serial number '000000000XX0' between the asterisks.</p></div></td></tr></tbody></table>	AIRBAG SERIAL NUMBER IDENTIFICATION	<ul style="list-style-type: none">• The airbag serial number is ALWAYS the 12 DIGITS located BETWEEN the asterisks.• The 3 digits before the asterisk ARE NOT part of the serial number, and SHOULD NOT be entered or an inaccurate response may be returned.	<p data-bbox="954 474 1442 506">Airbag Serial Number Label Example</p> <div data-bbox="878 520 1520 663"><p>The image shows a label with a barcode and the text 'F22 *000000000XX0*'. A green box highlights the 12-digit serial number '000000000XX0' between the asterisks.</p></div>
AIRBAG SERIAL NUMBER IDENTIFICATION				
<ul style="list-style-type: none">• The airbag serial number is ALWAYS the 12 DIGITS located BETWEEN the asterisks.• The 3 digits before the asterisk ARE NOT part of the serial number, and SHOULD NOT be entered or an inaccurate response may be returned.				
<p data-bbox="954 474 1442 506">Airbag Serial Number Label Example</p> <div data-bbox="878 520 1520 663"><p>The image shows a label with a barcode and the text 'F22 *000000000XX0*'. A green box highlights the 12-digit serial number '000000000XX0' between the asterisks.</p></div>				



The **AIRBAG ASSEMBLY** serial number and the **INFLATOR** serial number are **DIFFERENT**. The **AIRBAG ASSEMBLY** serial number **MUST** be recorded prior to replacement.



Takata Scan App

TMS Test Dealership

[Search Another VIN](#) | [Print Screen](#) | [Log Out](#)

ORIGINAL Serial Number

Scan or enter the **original** Airbag Assembly Serial Number into the website.

VIN:

* Serial Number of **Original** Airbag Assembly:

* Re-confirm the Serial Number of **Original** Airbag Assembly:

Check if the original airbag assembly serial number is not visible or missing

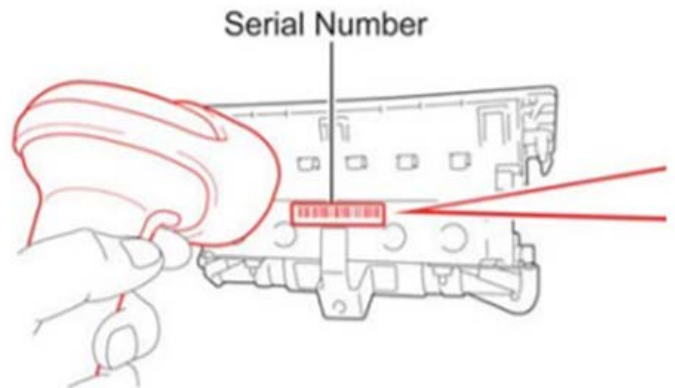

If the airbag serial number and barcode are not legible or are not present, check the box in the application indicating the serial number is not legible and continue with the repair.

c) Scan the NEW airbag barcode in the Serial Number Recording Application.



Takata Scan App

TMS Test Dealership

[Search Another VIN](#) | [Print Screen](#) | [Log Out](#)

NEW Serial Number

Scan or enter the **new** Airbag Assembly Serial Number into the website.

VIN:

* Serial Number of New Airbag Assembly:

* Re-confirm the Serial Number of New Airbag Assembly:

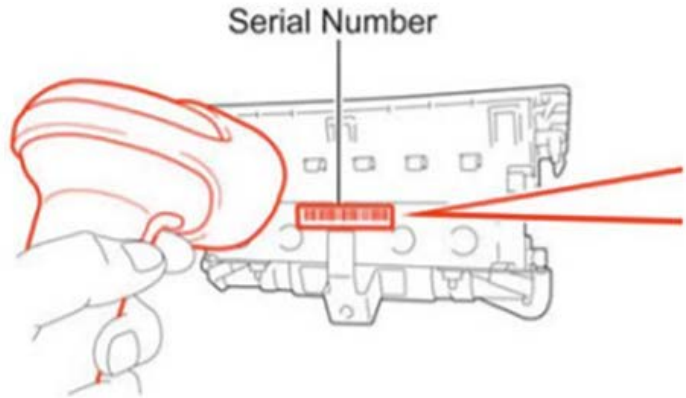

The new **AIRBAG ASSEMBLY** serial number **MUST** be recorded prior to reinstallation to track the airbag assembly to the vehicle.

- d) Record your name, Tech SPIN ID, and mileage in the boxes
- e) Check the two acknowledgement boxes and click search

Additional Information and Agreements

Provide additional information below before proceeding to obtain warranty authorization number.

VIN:

Original Serial:

New Serial:

Technician Name:

Technician ID:

Mileage on Vehicle:

Required Acknowledgements:

I agree to complete the safety recall's remaining technical instructions

I agree to perform a vehicle Health Check with Techstream upon completion of the safety recall's technical instructions

f) Document the warranty authorization number for the warranty claim



Takata Scan App

TMS Test Dealership

[Search Another VIN](#) | [Print Screen](#) | [Log Out](#)

Takata Scan App Final Results

You can [Print Screen](#) or [Search Another VIN](#).

VIN:	
Scan Date:	08/23/2019 07:00AM (mm/dd/yyyy)
Warranty Authorization Number:	55154K08
<i>This number is required for the warranty claim. Print and save this screen for your records</i>	



The warranty authorization number must be recorded on every warranty claim for each repair

6. NEW SERIAL NUMBER (WEBSITE WILL NOT ACCEPT NEW SERIAL NUMBER)

- a) If directed to the screen below this indicates the serial number entered is not loaded in the system. Confirm if the blue check mark is on the box. If yes, follow the instructions on the screen.

NOTE: Ensure you include a Job Aid and a picture of the Airbag Assembly in your email

Takata Scan App

Administrator

[Search Another VIN](#) | [Print Screen](#) | [Log Out](#)

NEW Serial Number (confirm if marked label)

NOTE: This serial number 123456789123 is not recognized. This part should be returned to Toyota **UNLESS there is a mark on the label** (shown below). If there is a mark on the label submit a picture of the airbag assembly and a job aid to quality_compliance@toyota.com and await further instructions.

...OR [return to original New Serial Number screen](#) to re-enter another number.

VIN:
2T1BR32E73C118968

Serial Number:
123456789123



X. MODULE REPLACEMENT



1. WORKING WITH AIRBAG

- Carefully place the airbag on the bench inflator side up.

NOTE: Place clean sheet(s) of paper on the bench to protect the airbag.

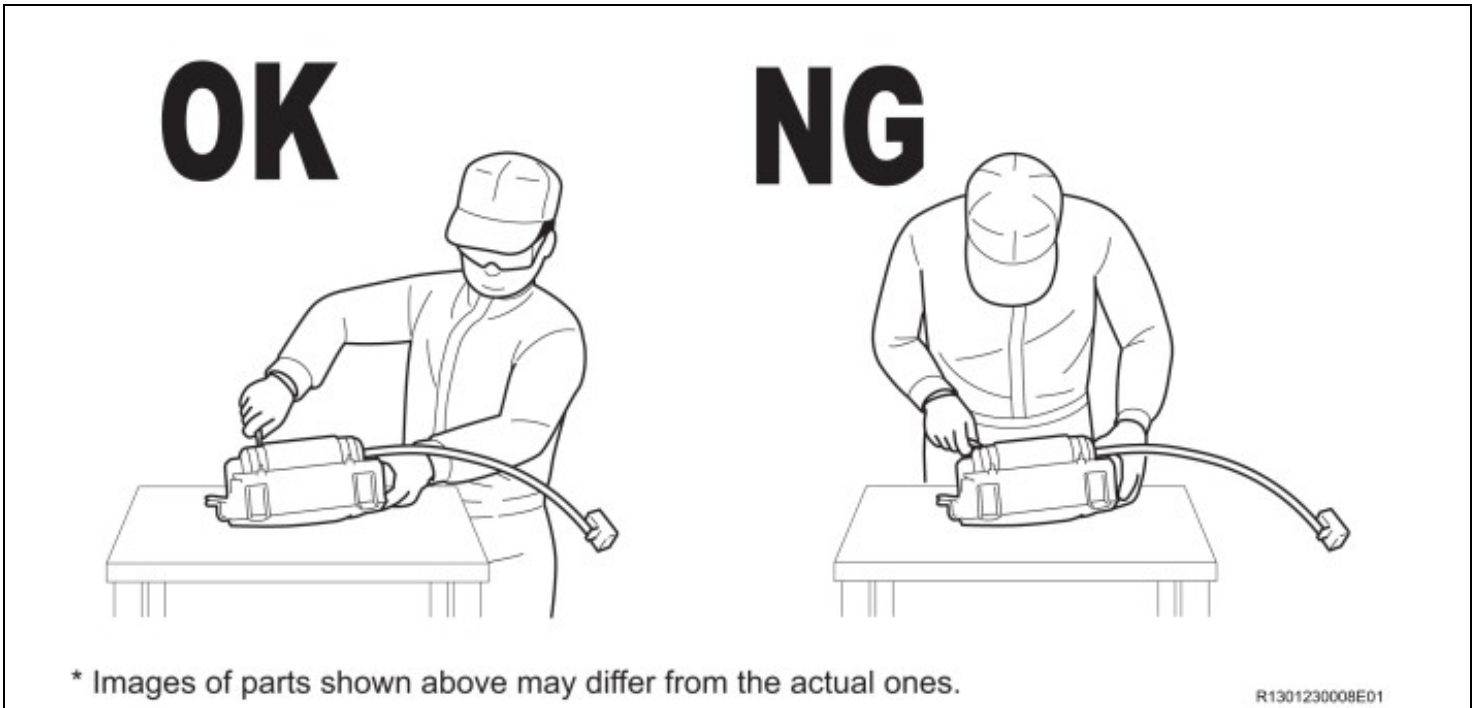
- Avoid standing directly over the inflator.



	CRITICAL INFORMATION – READ THOROUGHLY	
	<p>Remember to periodically touch a metallic part of the vehicle to discharge static electricity in the body if the anti-static kit is not being used.</p>	

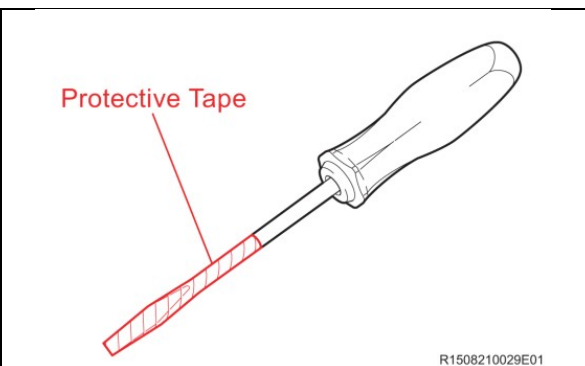

2. TOOL PREPARATION

- Wrap a screwdriver with tape.

3. REMOVE THE COVER

- a) Gently insert the screwdriver between the airbag door and module and disengage the claws holding the door to the module. Please refer to the video below.

[VIDEO](#)

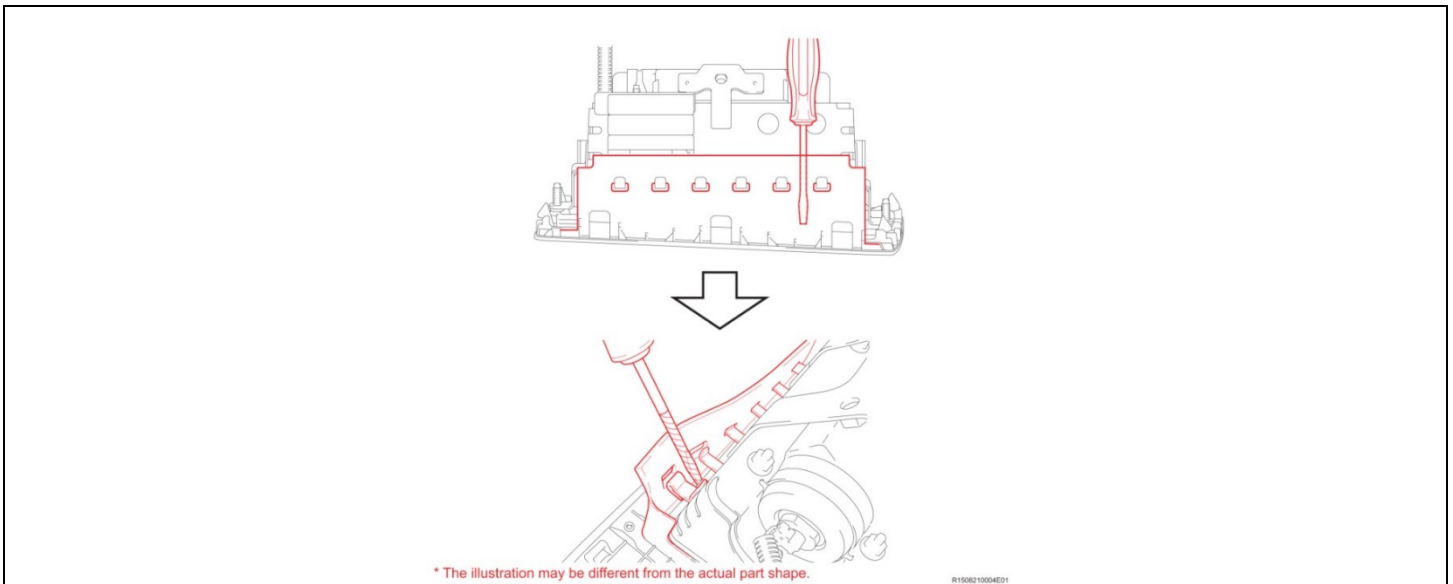

- b) After all the claws have been disengaged separate the module from the door.
- c) Mark the old module so it is not reused.
- d) Inspect the door for damage to the mounting slots.

Take care not to mistake the mounting direction.

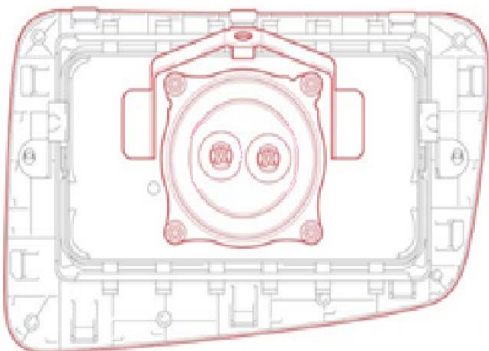

4. INSTALL THE NEW MODULE

- a) Carefully slide the new module into the airbag door.

NOTE: Mounting direction.

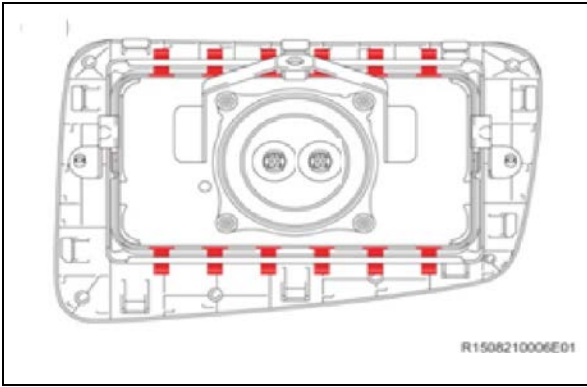

b) Reengage the tangs of the module into the door using the screwdriver with the shaft wrapped in tape.

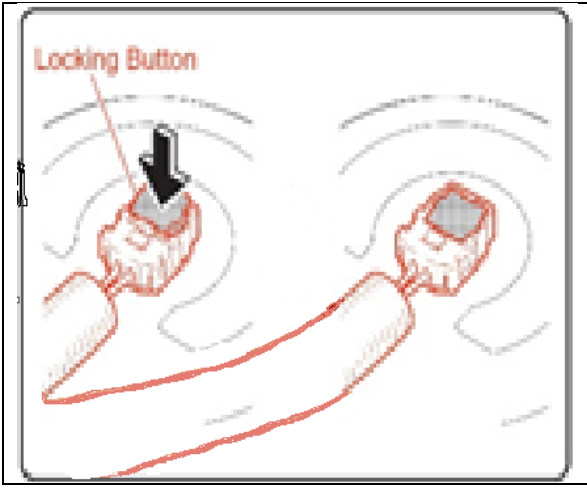

c) Connect the new harness to the new module.
d) Press the lock tab down.

XI. FRONT PASSENGER AIRBAG ASSEMBLY INSTALLATION

1. REINSTALL THE AIRBAG ASSEMBLY

Note: During reinstallation of the airbag assembly, ensure the 12mm bolt and two 10mm nuts securing the airbag assembly to the instrument panel are installed and torqued to the required specification identified on TIS.

a) Refer to TIS for instructions on airbag installation:

Matrix [2005MY](#) [2006MY](#) [2007MY](#) [2008MY](#)

2. RECONNECT THE NEGATIVE BATTERY CABLE

3. PERFORM A HEALTH CHECK AND DIAGNOSTIC REPORT

◀ VERIFY REPAIR QUALITY ▶

- Confirm all precautions are followed to ensure safety during the repair
- Confirm the entire serial number checker application is completed and the warranty authorization # is recorded on *EVERY* vehicle
- Confirm the old module is handled safely and given to the appropriate parts professional for shipment
- Confirm the new harness connector is fully engaged and routed correctly.

If you have any questions regarding this update, please contact your regional representative.

XII. APPENDIX

A. CAMPAIGN DESIGNATION DECODER

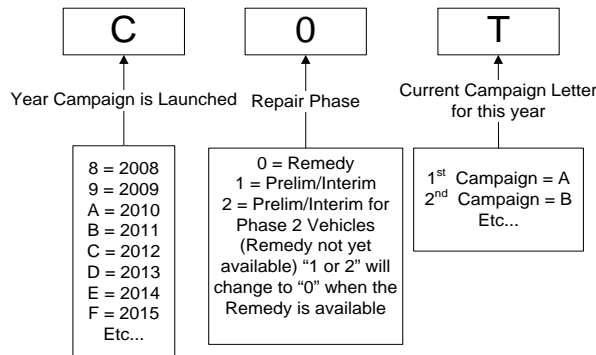

B. CAMPAIGN PARTS DISPOSAL

ALL inflators that are removed from vehicles under this campaign **MUST** be packaged and shipped back to the inflator manufacturer following the manufacturer's instructions. The instructions can be found in the following locations:

- Attached to the dealer letter