

**2007-2012 CX-7, 2007-2013 CX-9, 2009-2013 MAZDA6 - PASSENGER AIR BAG SAFETY  
RECALL 1317F**

**A. VEHICLE INSPECTION PROCEDURE**

1. Verify that the vehicle is within the following ranges:

Model
2007-2012 CX-7
2007-2013 CX-9
2009-2013 Mazda6

- If the vehicle is within the above ranges, proceed to Step 2.
  - If the vehicle is not within the above ranges, return vehicle to the customer or inventory.
2. Perform a Warranty Vehicle Inquiry using your eMDCS System and inspect vehicle for Campaign Labels **Recall 1317F** attached to the vehicle's hood or bulkhead. Refer to eMDCS System - Warranty Vehicle Inquiry Results table below.

**NOTE:** Be sure to verify Recall number as the vehicle may have multiple Recall labels.

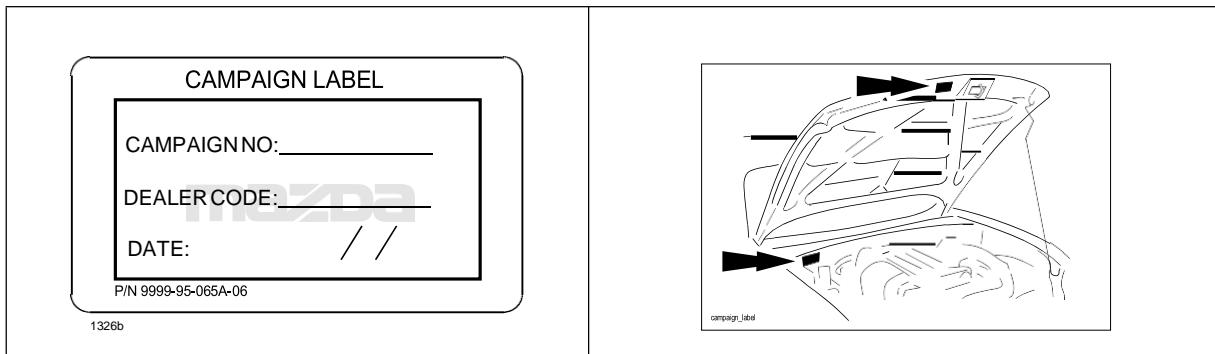

**eMDCS System - Warranty Vehicle Inquiry Results:**

If eMDCS displays:	Campaign Label is:	Action to perform:
RECALL 1317F OPEN	Present	Contact the Warranty Hotline at (877) 727-6626, option 3, to update vehicle history.
	Not present	Proceed to "B. REPAIR PROCEDURE".
RECALL 1317F CLOSED	Present	Return vehicle to inventory or customer.
	Not present	Proceed to "C. CAMPAIGN LABEL INSTALLATION".
RECALL 1317F is not displayed	Does not apply	Recall does not apply to this vehicle. Return vehicle to inventory or customer.



**2007-2012 CX-7, 2007-2013 CX-9, 2009-2013 MAZDA6 - PASSENGER AIR BAG SAFETY RECALL 1317F**

**B. REPAIR PROCEDURE**

Year / Model	Page No.
CX-7	3
CX-9	11
Mazda6	19

**CX-7:**

**Passenger-Side Air Bag Inflator Replacement Procedure:**



Felt Tape as needed for repairs as outlined in red in the repair instructions. **This part will arrive automatically with airbag inflator kits shipped on or after October 30th, 2017.**

The Felt Tape will come in a plastic bag, (2) pcs of felt onto (1) liner. Each Piece is 20mm x 50mm. The center of the liner is kiss-cut so it bends so that each piece of felt can easily peel off. The bag is 5" x 7".



**2007-2012 CX-7, 2007-2013 CX-9, 2009-2013 MAZDA6 - PASSENGER AIR BAG SAFETY RECALL 1317F**

	<b>KIT Component</b>	<b>Quantity</b>
1	Inflator (APPS-7) EGZ1-57-K80	1
2	Collar (Black)	1
3	Stopper Plate	1
4	Lock Nut M5	4
5	Wire Harness	1
6	CE Label	1
7*	Felt Tape	1 (2 pcs.)

**\* (1) Felt tape (Quantity 2 pcs in 1 package) P/N ZZT1-57-K75 are bundled with airbag inflator kits arriving after October 30th, 2017.**

**NOTE:** The wire harness (5) is not genuine. The coupler clip and harness length will be different.

Pack and return the removed inflator as follows:

**IMPORTANT:** Be sure to follow the packing and shipping instructions provided in the carton and in the Air Bag Inflator Return Instructions available on MGSS.

- CAUTION:**
- Use the same carton which was used to deliver a new inflator. It is a specialized box that is internationally accepted for shipping an inflator.
  - Pack the old inflator in the box exactly in the same manner as the new inflator was packed.

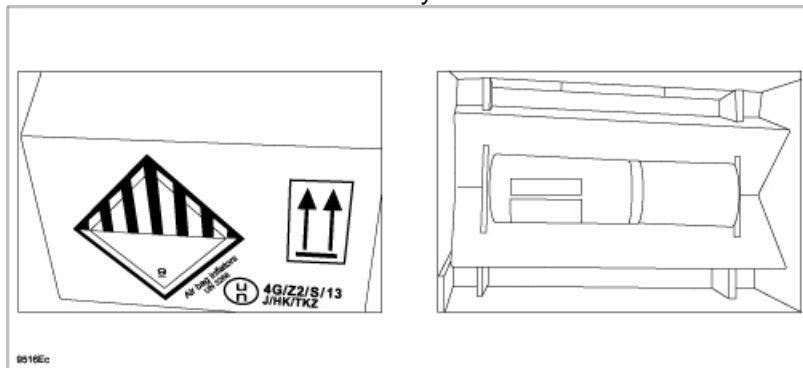

## 2007-2012 CX-7, 2007-2013 CX-9, 2009-2013 MAZDA6 - PASSENGER AIR BAG SAFETY RECALL 1317F

### Air Bag Module Removal:

#### WARNING:

- Perform the replacement in a clean environmental. Oil, grease, water, etc. on components may cause the air bag modules to fail to deploy in an accident, which may cause serious injury. Do not allow oil, grease, water, etc., on components.
  - Inserting a screwdriver, etc., into the connector of an air bag module may damage the connector and cause the air bag module to deploy improperly, which may cause serious injury. Do not insert any foreign objects into the connector.
  - Do not disassemble the vehicle, other than instructed here.
  - Do not make an attempt to directly supply electrical power to the module and the inflator.
  - Keep the module facing of the pad surface upwards at all times, except during replacement.
  - Do not use the module and new inflator if they were dropped on the ground.
  - Avoid module and inflator exposure to temperatures of 194 degrees F (90 degrees C) or more.
1. Record the customer's preset radio stations and check the operation of the Passenger Airbag Deactivation (PAD) indicator in the information display to make sure it is operating correctly.
  2. Remove the passenger-side air bag module according to the instructions on MGSS. (see CX-7 PASSENGER-SIDE AIR BAG MODULE REMOVAL/INSTALLATION)

**CAUTION: When removing the dashboard, be careful when handling the information display. The Passenger Airbag Deactivation (PAD) indicator is very sensitive and can break easily.**

3. Lay a protective cloth on the work bench, then place the air bag module on it to avoid any damage or scratches to the surface.

### Inflator Replacement:

**NOTE:** To show the air bag module more clearly, the instrument panel trim was removed.

1. Remove the M5 nuts from 4 locations.

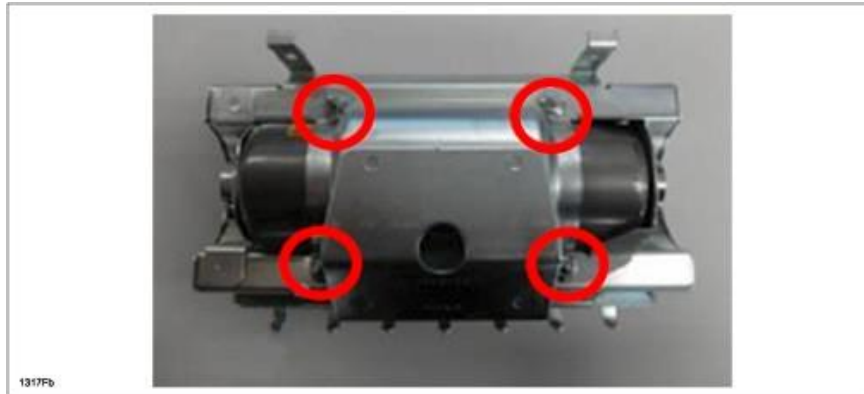

2. Remove the stopper plate and inflator.



**2007-2012 CX-7, 2007-2013 CX-9, 2009-2013 MAZDA6 - PASSENGER AIR BAG  
SAFETY RECALL 1317F**

3. Attach the felt tape (A) to the retainer in 2 places.

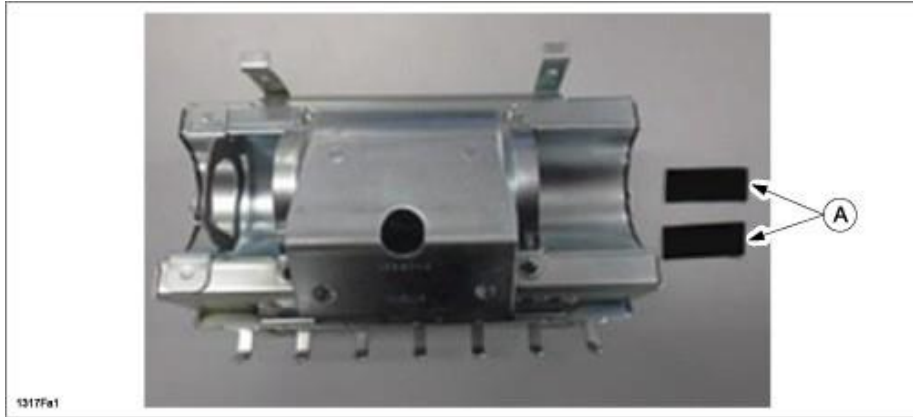

a. Attach one piece of felt tape in the straight area of the retainer (A) using the red line (B) on the lower part of the straight edge as reference. Fold in half and paste inside the retainer.

**CAUTION:** DO NOT attach the felt tape past the red line (bolt side) to prevent it from contacting the assembly nut.

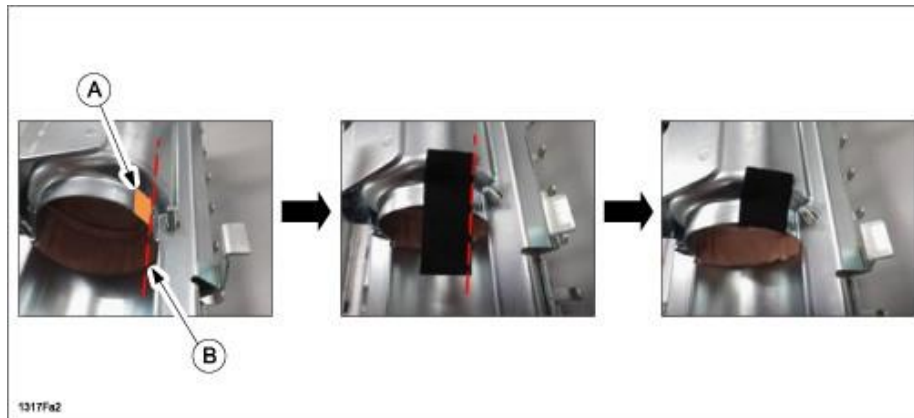

b. Attach the other felt tape on the other side of the retainer.

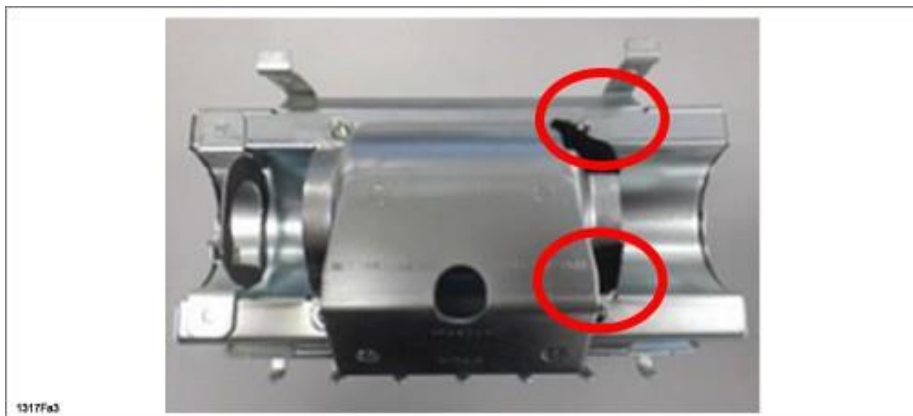

**2007-2012 CX-7, 2007-2013 CX-9, 2009-2013 MAZDA6 - PASSENGER AIR BAG SAFETY RECALL 1317F**

4. Insert the new inflator into the retainer.

**NOTE:** Make sure to orientate the 1st and 2nd stage direction before inserting the inflator into the retainer.

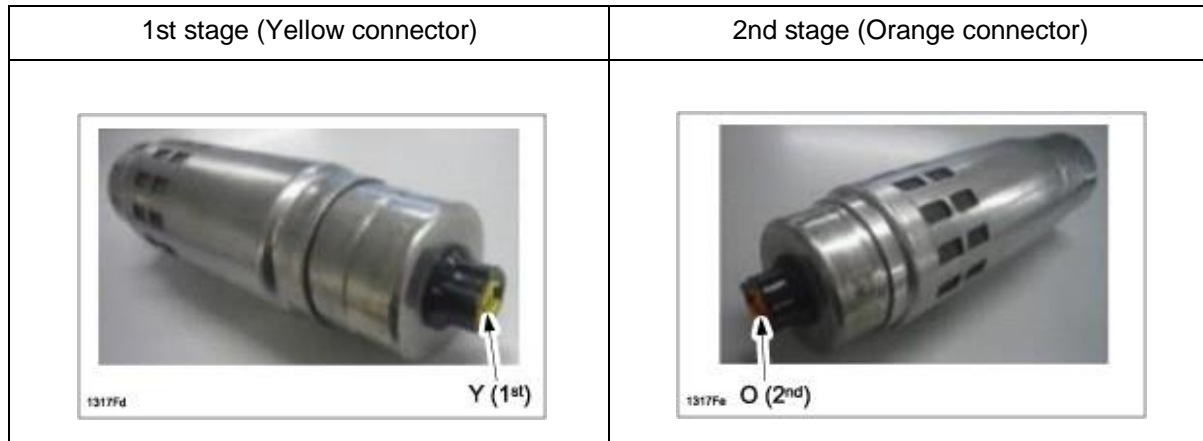

a. Attach the collar D to the 2nd stage side of the new inflator.

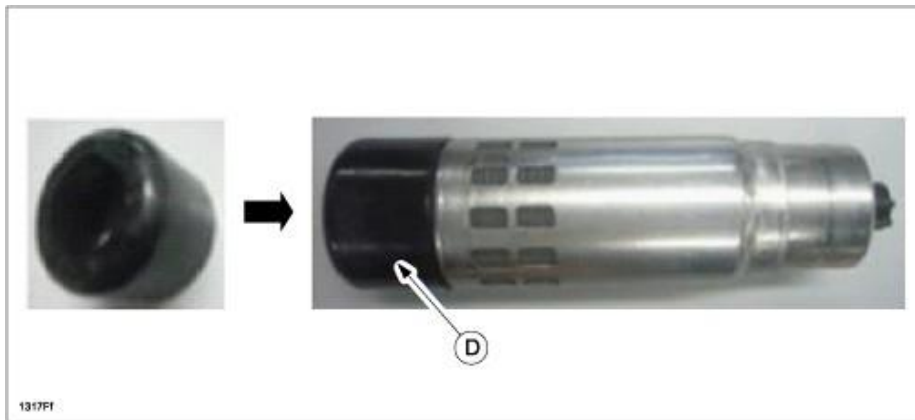

b. Insert the new inflator and align the side of the retainer and guide line of the inflator (A).

**NOTE:** Align the guide line (red line) within 5 mm from the retainer edge (B).

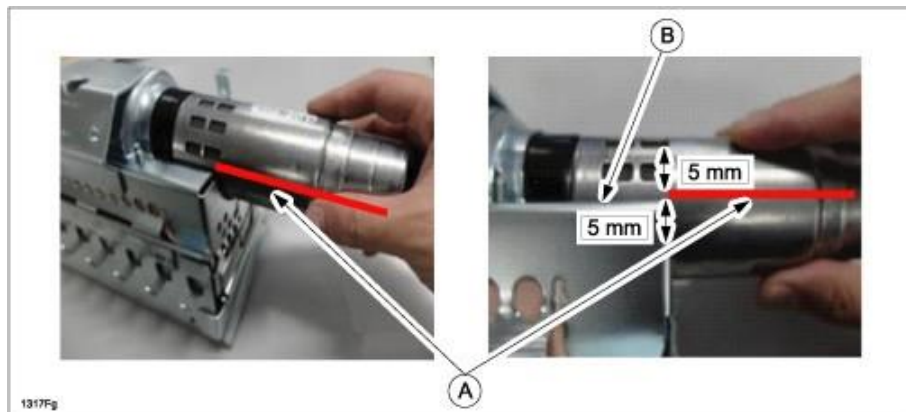

**2007-2012 CX-7, 2007-2013 CX-9, 2009-2013 MAZDA6 - PASSENGER AIR BAG SAFETY RECALL 1317F**

5. Confirm that the inflator is assembled correctly.

**NOTE:** Pay attention to the direction of the connector. The connector direction is perpendicular to the bottom of the retainer.

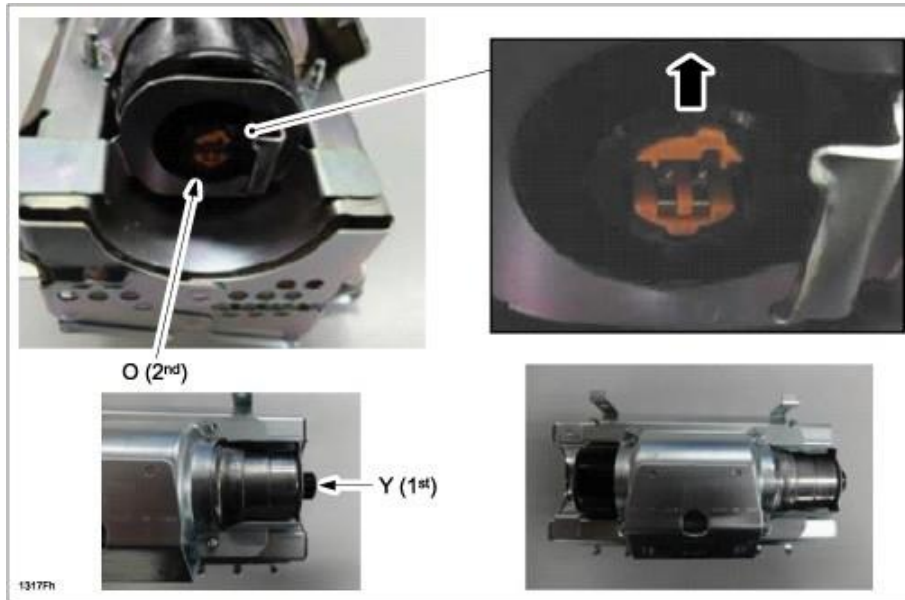

6. Install the new stopper to the retainer.

7. Install the new M5 nuts in 4 locations.

**Tightening torque: 34.5 ± 2.6 in-lb (3.9 ± 0.4 Nm)**

**Short-cord Replacement:**

1. Attach the SHORT-CORD-A/B to the vehicle with a tie wrap so that it does not contact any other surrounding parts.

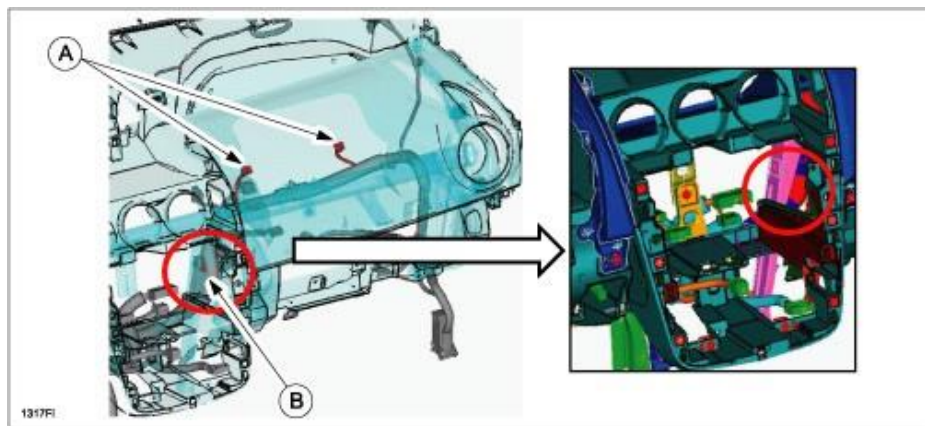



**2007-2012 CX-7, 2007-2013 CX-9, 2009-2013 MAZDA6 - PASSENGER AIR BAG  
SAFETY RECALL 1317F**

2. Install the new wire harness contained in the KIT (A) and fix the wire harness with a tie wraps (shop supply) at each point shown (B).

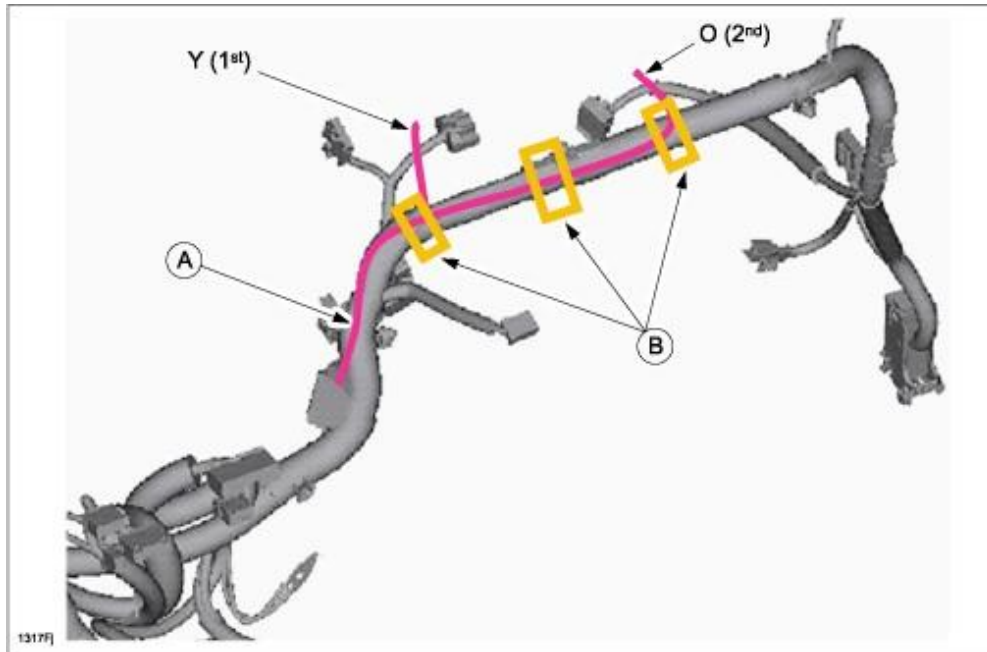

View from the underside.

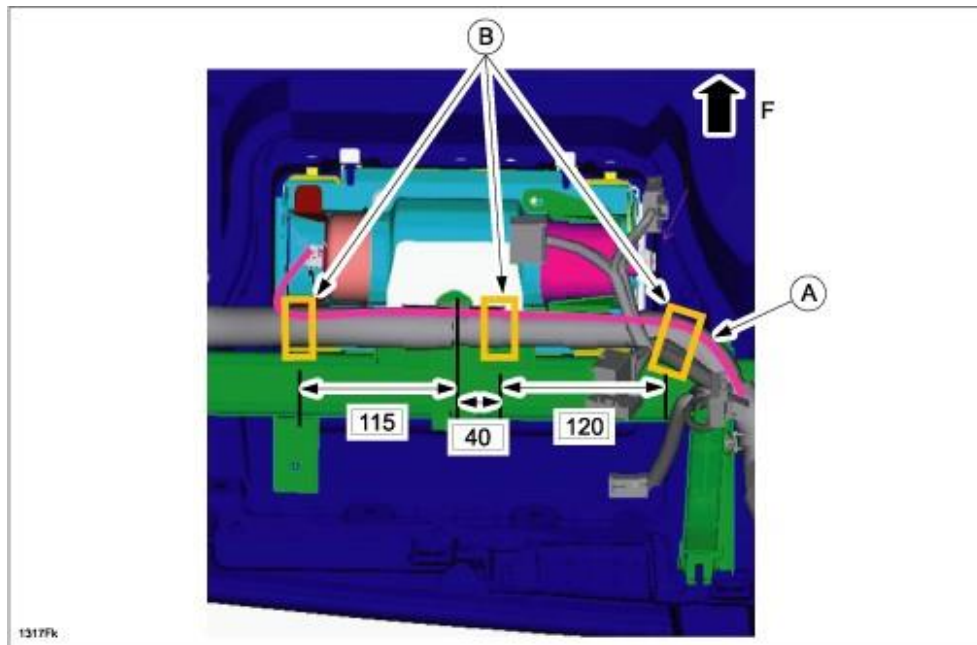

**2007-2012 CX-7, 2007-2013 CX-9, 2009-2013 MAZDA6 - PASSENGER AIR BAG  
SAFETY RECALL 1317F**

**Air Bag Module Reinstallation:**

1. Install the passenger-side air bag module according to the instructions on MGSS.  
(see CX-7 PASSENGER-SIDE AIR BAG MODULE REMOVAL/INSTALLATION)
2. Reconnect the negative battery cable.
3. Turn the ignition switch to the ON position.
4. Verify that the air bag system warning light illuminates for approx. 6 sec., then goes out.

**NOTE:** If the air bag system warning light does not operate in the manner described above, there is a malfunction in the system. Inspect the system following the on-board diagnostic system procedure on MGSS (Restraints section).

5. Re-enter the customer's preset radio stations.
6. Proceed to "C. CAMPAIGN LABEL INSTALLATION".

**2007-2012 CX-7, 2007-2013 CX-9, 2009-2013 MAZDA6 - PASSENGER AIR BAG SAFETY RECALL 1317F**

**CX-9:**

**Passenger-Side Air Bag Inflator Replacement Procedure:**



**Felt Tape as needed for repairs as outlined in red in the repair instructions**

The Felt Tape will come in a plastic bag, (2) pcs of felt onto (1) liner. Each Piece is 20mm x 50mm. The center of the liner is kiss-cut so it bends so that each piece of felt can easily peel off. The bag is 5" x 7".



	<b>KIT Component</b>	<b>Quantity</b>
1	Inflator (APPS-7) EGZ1-57-K80	1
2	Collar (Black)	1
3	Stopper Plate	1
4	Lock Nut M5	4
5	Wire Harness	1
6	CE Label	1
7*	Felt Tape	1 (2 pcs.)

**\* (1) Felt tape (Quantity 2 pcs in 1 package) can be ordered using P/N ZZT1-57-K75**

**NOTE:** The wire harness (5) is not genuine. The coupler clip and harness length will be different.

Pack and return the removed inflator as follows:

**IMPORTANT: Be sure to follow the packing and shipping instructions provided in the carton and in the Air Bag Inflator Return Instructions available on MGSS.**

**2007-2012 CX-7, 2007-2013 CX-9, 2009-2013 MAZDA6 - PASSENGER AIR BAG  
SAFETY RECALL 1317F**

**CAUTION:**

- Use the same carton which was used to deliver a new inflator. It is a specialized box that is internationally accepted for shipping an inflator.
- Pack the old inflator in the box exactly in the same manner as the new inflator was packed.

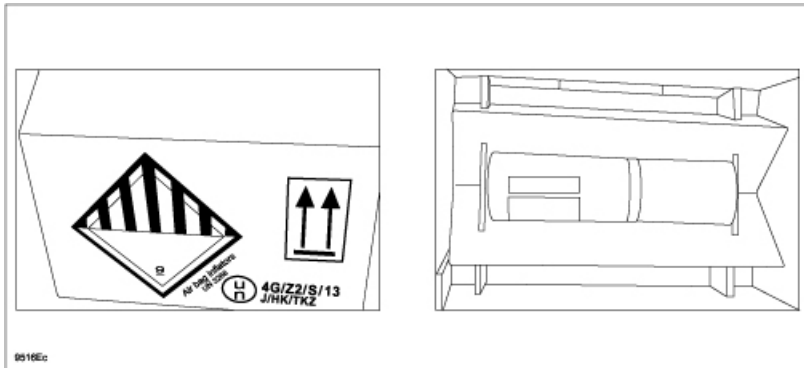

## 2007-2012 CX-7, 2007-2013 CX-9, 2009-2013 MAZDA6 - PASSENGER AIR BAG SAFETY RECALL 1317F

### Air Bag Module Removal:

#### WARNING:

- Perform the replacement in a clean environment. Oil, grease, water, etc. on components may cause the air bag modules to fail to deploy in an accident, which may cause serious injury. Do not allow oil, grease, water, etc., on components.
  - Inserting a screwdriver, etc., into the connector of an air bag module may damage the connector and cause the air bag module to deploy improperly, which may cause serious injury. Do not insert any foreign objects into the connector.
  - Do not disassemble the vehicle, other than instructed here.
  - Do not make an attempt to directly supply electrical power to the module and the inflator.
  - Keep the module facing of the pad surface upwards at all times, except during replacement.
  - Do not use the module and new inflator if they were dropped on the ground.
  - Avoid module and inflator exposure to temperatures of 194 degrees F (90 degrees C) or more.
1. Record the customer's preset radio stations.
  2. Remove the passenger-side air bag module according to the instructions on MGSS. (see CX-9 PASSENGER-SIDE AIR BAG MODULE REMOVAL/INSTALLATION)
  3. Lay a protective cloth on the work bench, then place the air bag module on it to avoid any damage or scratches to the surface.

### Inflator Replacement:

**NOTE:** To show the air bag module more clearly, the instrument panel trim was removed.



1. Remove the connector of the harness assembly.
  - a. Pull the locking pin up using a thin tool at the tip.

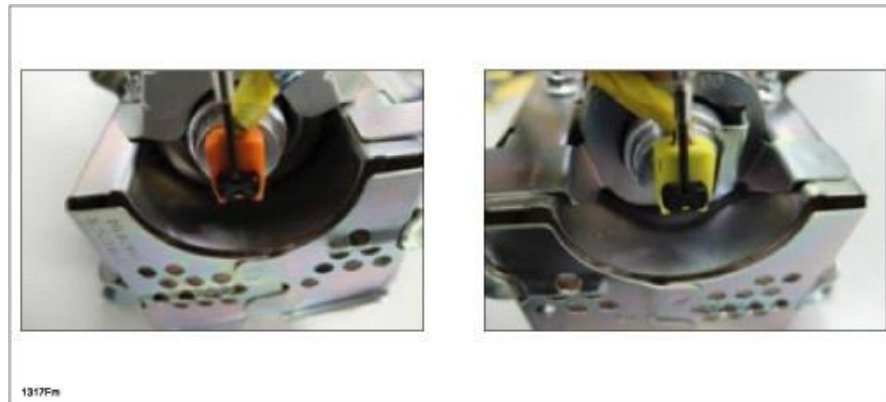

**2007-2012 CX-7, 2007-2013 CX-9, 2009-2013 MAZDA6 - PASSENGER AIR BAG  
SAFETY RECALL 1317F**

- b. Remove the clip from the coupler.

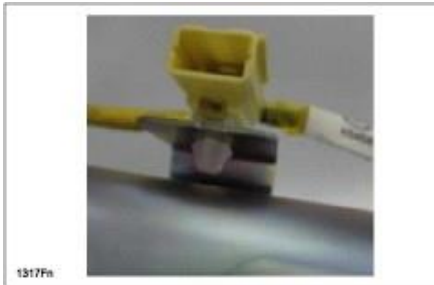

- 2. Remove the M5 nuts from 4 locations.

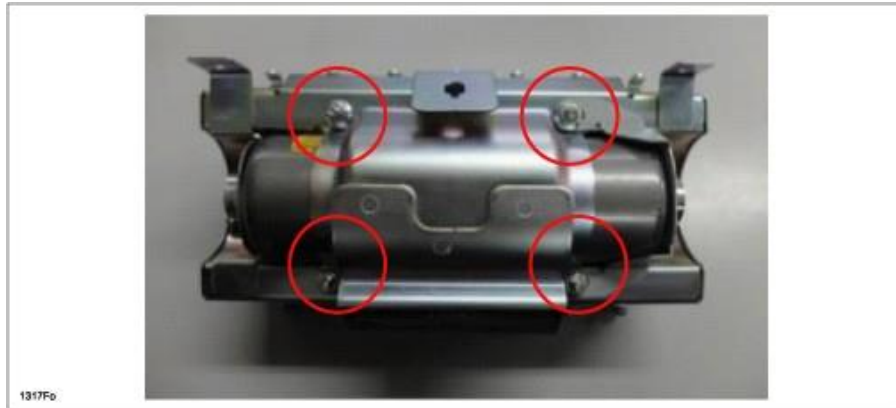

- 3. Remove the stopper plate and inflator.



**2007-2012 CX-7, 2007-2013 CX-9, 2009-2013 MAZDA6 - PASSENGER AIR BAG SAFETY RECALL 1317F**

4. Attach the felt tape (A) to the retainer in 2 places.



a. Attach one piece of felt tape in the straight area of the retainer (A) using the red line (B) on the lower part of the straight edge as reference. Fold in half and paste inside the retainer.

**CAUTION:** DO NOT attach the felt tape past the red line (bolt side) to prevent it from contacting the assembly nut.

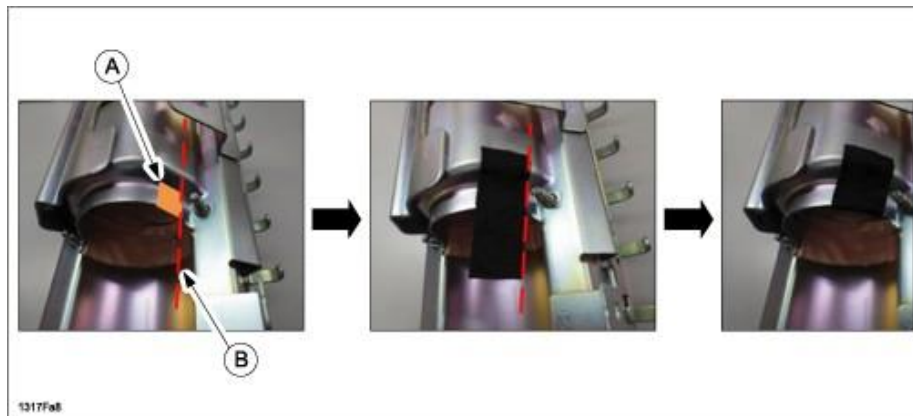

b. Attach the other felt tape on the other side of the retainer.

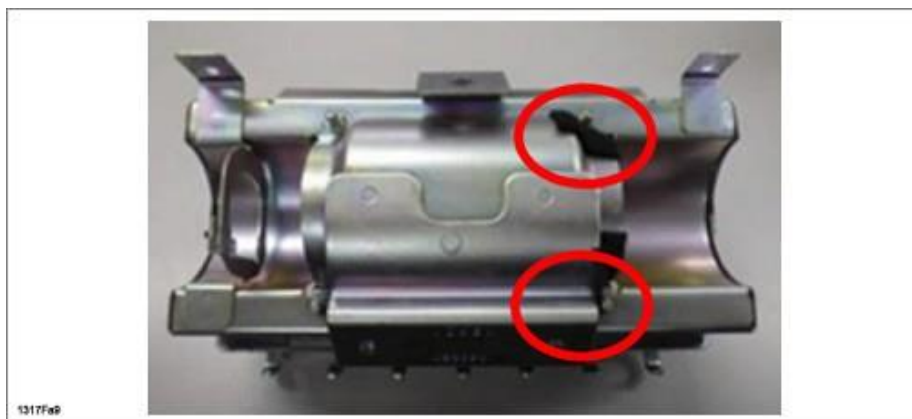

**2007-2012 CX-7, 2007-2013 CX-9, 2009-2013 MAZDA6 - PASSENGER AIR BAG SAFETY RECALL 1317F**

**NOTE:** Paste along the side of the bracket.

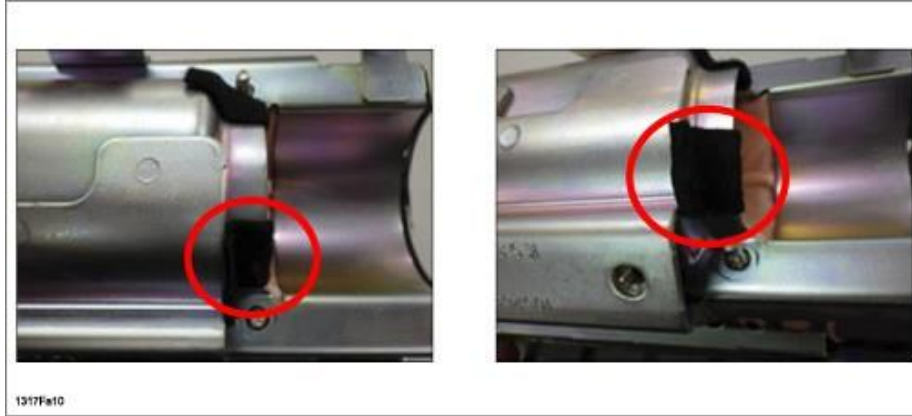

5. Insert the new inflator into the retainer

**NOTE:** Make sure to orientate the 1st and 2nd stage direction before inserting it into the retainer.

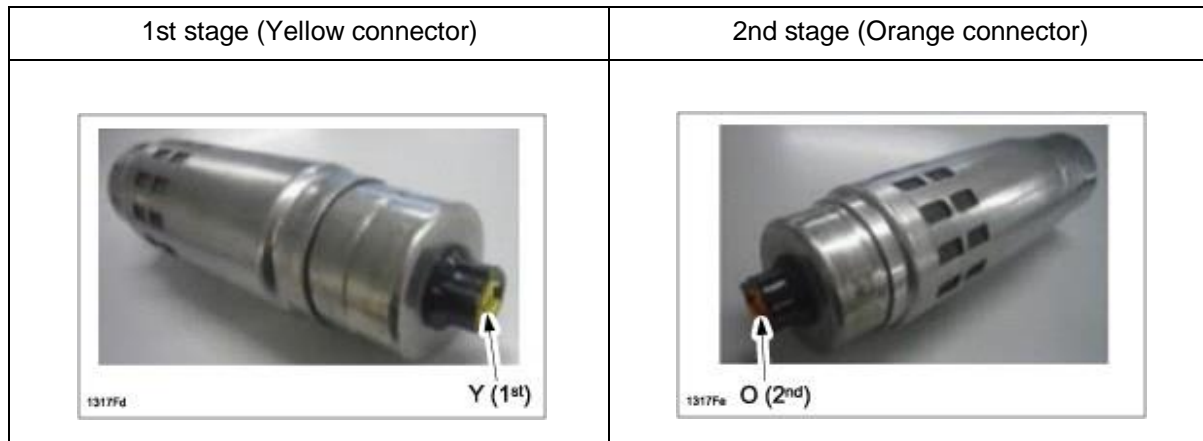

a. Attach the collar D to the 2nd stage side of the new inflator.

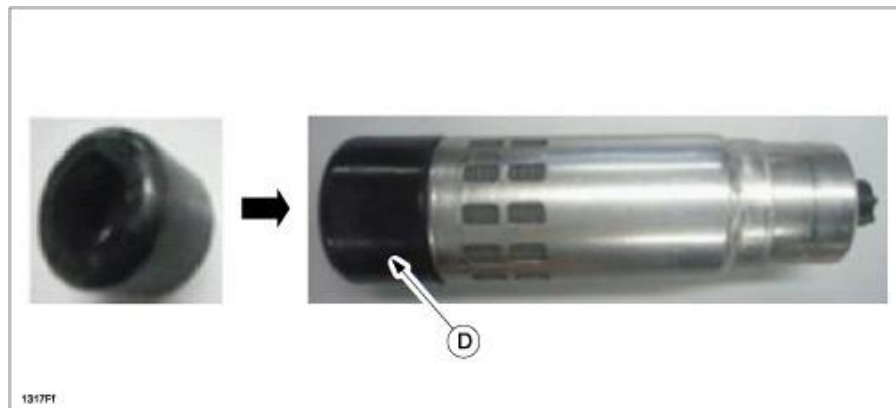



**2007-2012 CX-7, 2007-2013 CX-9, 2009-2013 MAZDA6 - PASSENGER AIR BAG SAFETY RECALL 1317F**

- b. Insert the new inflator and align the side of the retainer and guide line of the inflator (A).

**NOTE:** Align the guide line (red line) within 5mm from the retainer edge (B).

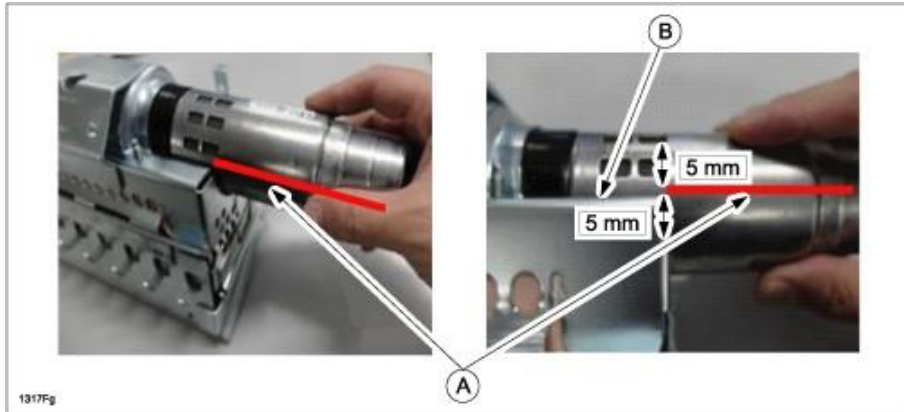

- 6. Confirm that the inflator is assembled correctly.

**NOTE:** Pay attention to the direction of the connector. The connector direction is perpendicular to the bottom of the retainer.

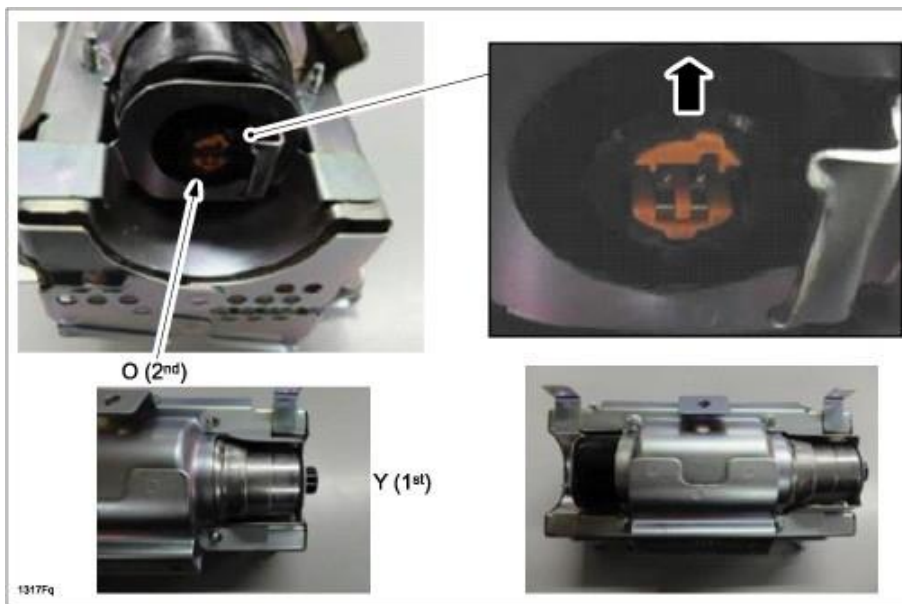

- 7. Install the new stopper to the retainer.
- 8. Install the new M5 nuts in 4 locations.  
**Tightening torque: 34.5 ± 2.6 in-lb (3.9 ± 0.4 Nm)**

**2007-2012 CX-7, 2007-2013 CX-9, 2009-2013 MAZDA6 - PASSENGER AIR BAG SAFETY RECALL 1317F**

9. Connect the replacement wire harness at 2 locations.
  - a. Make sure the connectors are fitted properly.

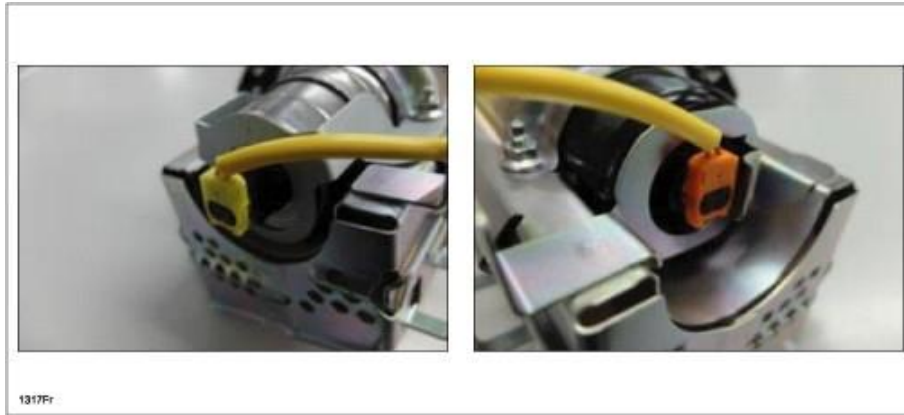

- b. The connectors direction is perpendicular to the bottom of the retainer.



**Air Bag Module Reinstallation:**

1. Install the passenger-side air bag module according to the instructions on MGSS. (see CX-9 PASSENGER-SIDE AIR BAG MODULE REMOVAL/INSTALLATION)
2. Reconnect the negative battery cable.
3. Turn the ignition switch to the ON position.
4. Verify that the air bag system warning light illuminates for approx. 6 sec., then goes out.

**NOTE:** If the air bag system warning light does not operate in the manner described above, there is a malfunction in the system. Inspect the system following the on-board diagnostic system procedure on MGSS (Restraints section).

5. Re-enter the customer's preset radio stations.
6. Proceed to "C. CAMPAIGN LABEL INSTALLATION".

**2007-2012 CX-7, 2007-2013 CX-9, 2009-2013 MAZDA6 - PASSENGER AIR BAG SAFETY RECALL 1317F**

**Mazda6:**

**Passenger-Side Air Bag Inflator Replacement Procedure:**



**Felt Tape as needed for repairs as outlined in red in the repair instructions**

The Felt Tape will come in a plastic bag, (2) pcs of felt onto (1) liner. Each Piece is 20mm x 50mm. The center of the liner is kiss-cut so it bends so that each piece of felt can easily peel off. The bag is 5" x 7".



	<b>KIT Component</b>	<b>Quantity</b>
1	Inflator (APPS-7) EGZ1-57-K80	1
2	Collar (Black)	1
3	Stopper Plate	1
4	Lock Nut M5	4
5	Wire Harness	1
6	CE Label	1
7*	Felt Tape	1 (2 pcs.)

**\* (1) Felt tape (Quantity 2 pcs in 1 package) can be ordered using P/N ZZT1-57-K75**

**NOTE:** The wire harness (5) is not genuine. The coupler clip and harness length will be different.

Pack and return the removed inflator as follows:

**IMPORTANT: Be sure to follow the packing and shipping instructions provided in the carton and in the Air Bag Inflator Return Instructions available on MGSS.**

**2007-2012 CX-7, 2007-2013 CX-9, 2009-2013 MAZDA6 - PASSENGER AIR BAG  
SAFETY RECALL 1317F**

**CAUTION:**

- Use the same carton which was used to deliver a new inflator. It is a specialized box that is internationally accepted for shipping an inflator.
- Pack the old inflator in the box exactly in the same manner as the new inflator was packed.

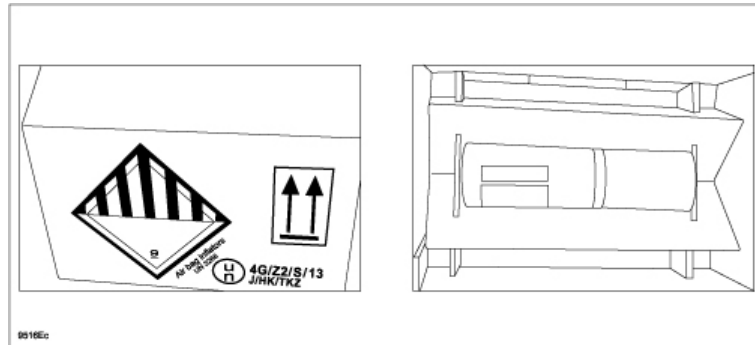

## 2007-2012 CX-7, 2007-2013 CX-9, 2009-2013 MAZDA6 - PASSENGER AIR BAG SAFETY RECALL 1317F

### Mazda6

#### Air Bag Module Removal:

##### WARNING:

- Perform the replacement in a clean environmental. Oil, grease, water, etc. on components may cause the air bag modules to fail to deploy in an accident, which may cause serious injury. Do not allow oil, grease, water, etc., on components.
  - Inserting a screwdriver, etc., into the connector of an air bag module may damage the connector and cause the air bag module to deploy improperly, which may cause serious injury. Do not insert any foreign objects into the connector.
  - Do not disassemble the vehicle, other than instructed here.
  - Do not make an attempt to directly supply electrical power to the module and the inflator.
  - Keep the module facing of the pad surface upwards at all times, except during replacement.
  - Do not use the module and new inflator if they were dropped on the ground.
  - Avoid module and inflator exposure to temperatures of 194 degrees F (90 degrees C) or more.
1. Record the customer's preset radio stations.
  2. Remove the passenger-side air bag module according to the instructions on MGSS. (see Mazda6 PASSENGER-SIDE AIR BAG MODULE REMOVAL/INSTALLATION)

#### Inflator Replacement:

**NOTE:** To show the air bag module more clearly, the instrument panel trim was removed.

1. **To prevent the inflator from exploding by mistake during its removal, short-circuit the harnesses.**

**NOTE:** The harness will not be reused after shorting it.



- a. Cut off the PVC tube to expose the wires.

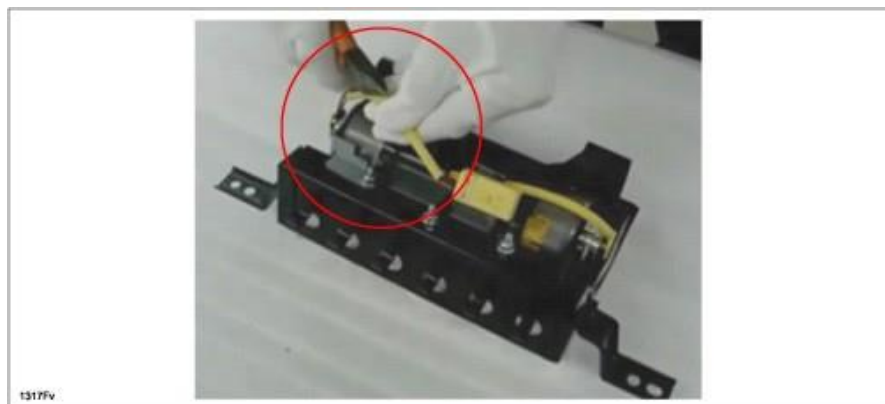

**2007-2012 CX-7, 2007-2013 CX-9, 2009-2013 MAZDA6 - PASSENGER AIR BAG SAFETY RECALL 1317F**

**NOTE:** Cut off the corrugated tubing for the two wire harnesses indicated by the arrows.

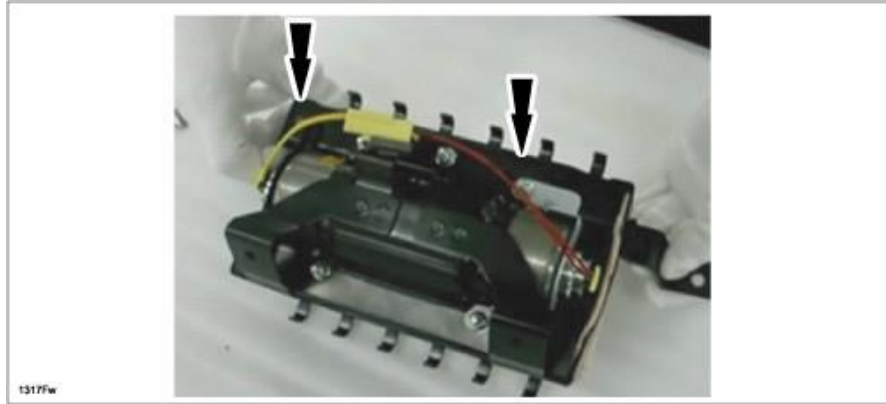

b. Strip the insulation from the two wires as shown.

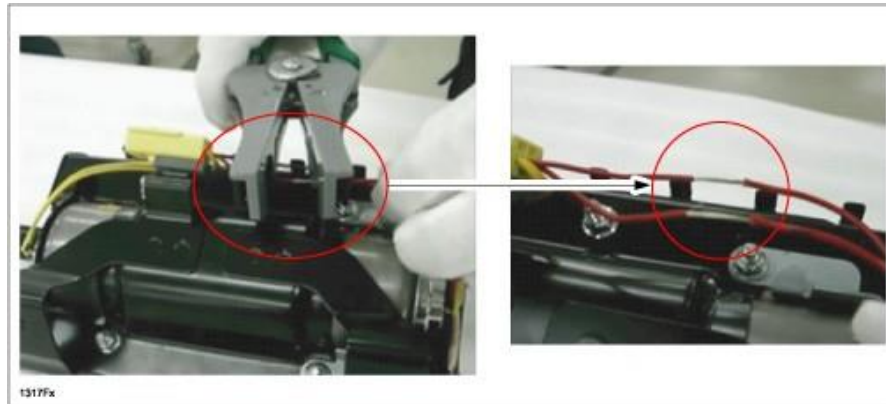

c. Connect the two wires by twisting them together (for both wire harnesses).

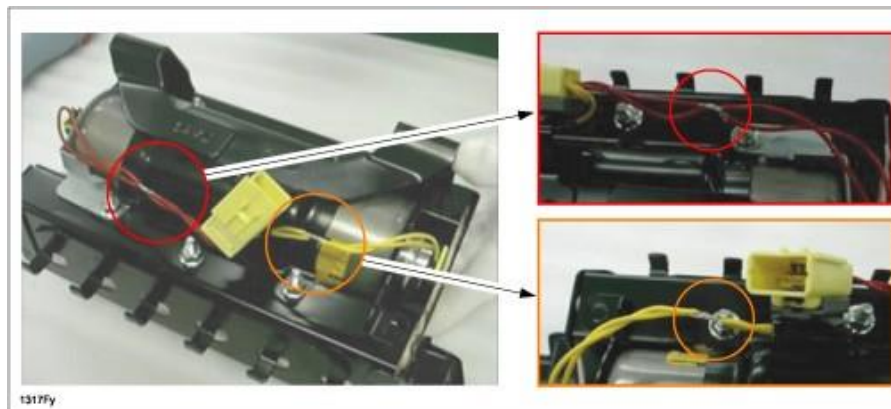



**2007-2012 CX-7, 2007-2013 CX-9, 2009-2013 MAZDA6 - PASSENGER AIR BAG  
SAFETY RECALL 1317F**

- d. Cut the two wires midway (A) between the connector and the splice (B) as shown.

**CAUTION:** Make sure to cut the wires on either side of the connector between the connector and the splice.

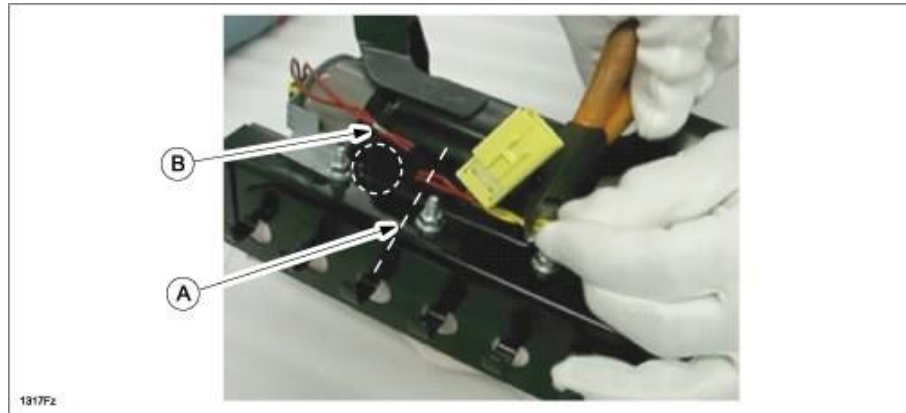

- 2. Remove the five (5) nuts (A).

**NOTE:** DO NOT excessively depress as the module body may detach from the air bag module.

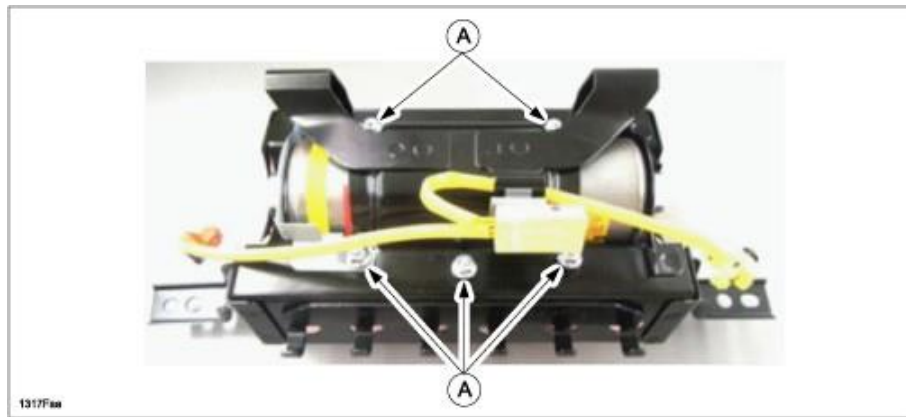

- 3. Remove the stopper plate (A).

**NOTE:** Discard four (4) of the nuts and the stopper plate. Keep one of the nuts.

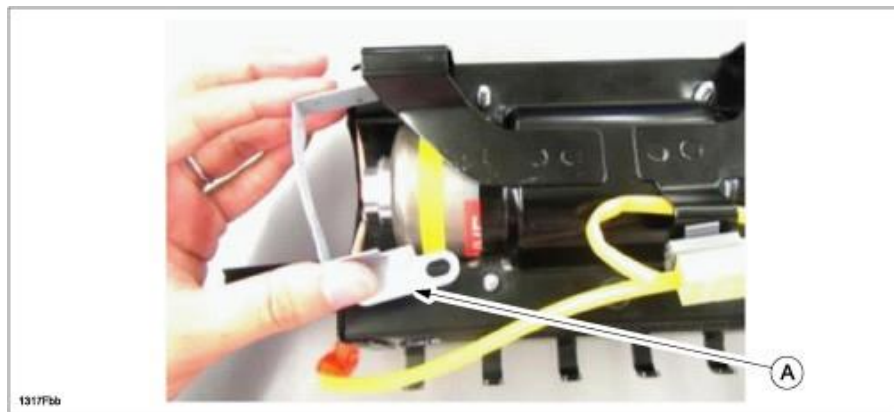



**2007-2012 CX-7, 2007-2013 CX-9, 2009-2013 MAZDA6 - PASSENGER AIR BAG SAFETY RECALL 1317F**

4. Push the inflator end with fingers, then remove it by sliding it in the direction shown.



5. Attach the felt tape (A) to the retainer in 2 places.



a. Attach one piece of felt tape in the straight area of the retainer (A) using the red line (B) on the lower part of the straight edge as reference. Fold in half and paste inside the retainer.

**CAUTION:** DO NOT attach the felt tape past the red line (bolt side) to prevent it from contacting the assembly nut.





**2007-2012 CX-7, 2007-2013 CX-9, 2009-2013 MAZDA6 - PASSENGER AIR BAG SAFETY RECALL 1317F**

b. Attach the other felt tape on the other side of the retainer.



6. Insert the new inflator into the retainer

**NOTE:** Make sure to orientate the 1st and 2nd stage direction before inserting it into the retainer.

1st stage (Yellow connector)	2nd stage (Orange connector)
 <p>A photograph of the 1st stage of an inflator, showing a yellow connector. An arrow points to the connector with the label 'Y (1st)'. The image is labeled '1317Fd' in the bottom left corner.</p>	 <p>A photograph of the 2nd stage of an inflator, showing an orange connector. An arrow points to the connector with the label 'O (2nd)'. The image is labeled '1317Fe' in the bottom left corner.</p>

a. Attach the collar D to the 2nd stage side of the new inflator.

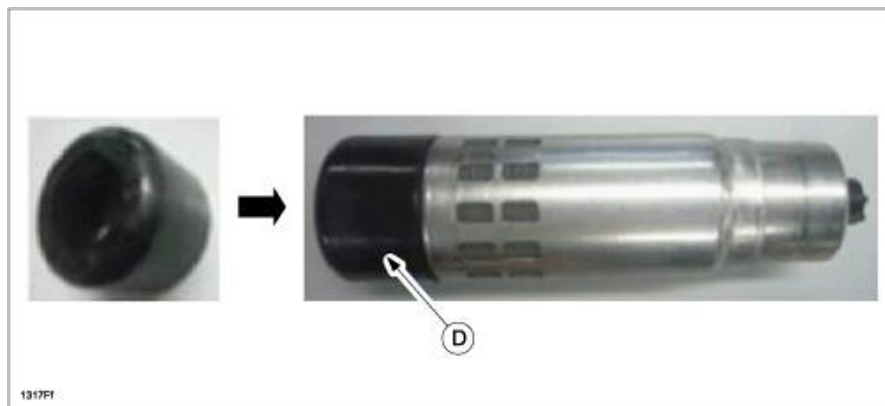

**2007-2012 CX-7, 2007-2013 CX-9, 2009-2013 MAZDA6 - PASSENGER AIR BAG SAFETY RECALL 1317F**

- b. Insert the new inflator and align the side of the retainer and guide line of the inflator (A).

**NOTE:** Align the guide line (red line) within 5mm from the retainer edge (B).

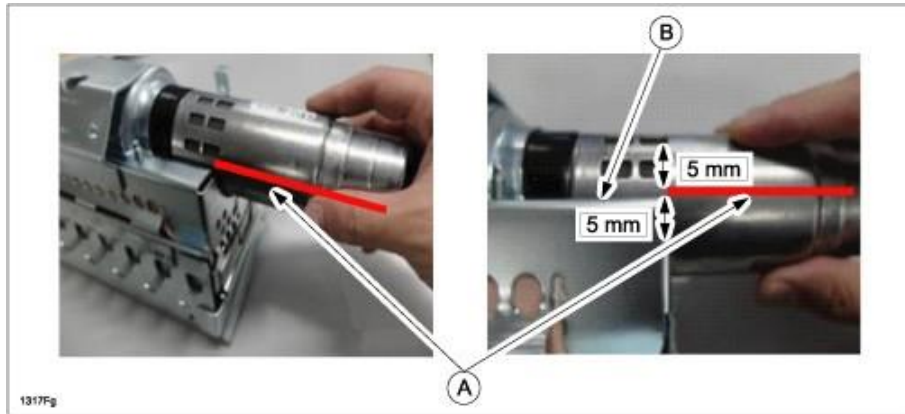

- 7. Confirm that the inflator is assembled correctly.

**NOTE:** Pay attention to the direction of the connector. The connector direction is perpendicular to the bottom of the retainer.

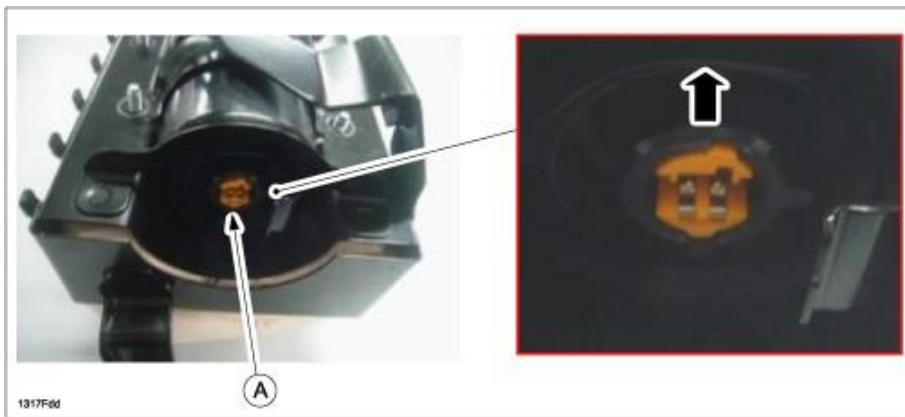

- 8. Install the new stopper to the retainer.



**2007-2012 CX-7, 2007-2013 CX-9, 2009-2013 MAZDA6 - PASSENGER AIR BAG  
SAFETY RECALL 1317F**

9. Install the new M5 nuts and one used nut (in position 3) as shown, then tighten the 5 nuts to the specified torque in the order shown.

**Tightening torque: 34.5 ± 2.6 in-lb (3.9 ± 0.4 Nm)**

**CAUTION:** DO NOT over tighten the nuts or the stud bolts could be removed from their press-fit points.

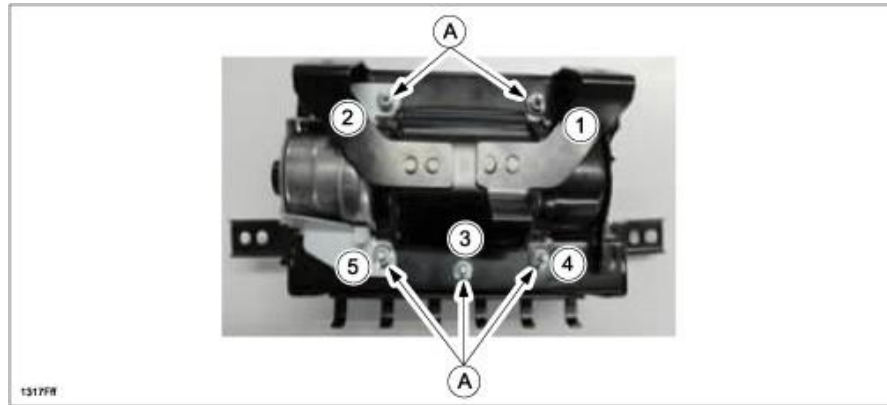

10. Connect the replacement wire harness at 2 locations.

**NOTE:** Make sure the connectors are fitted properly.

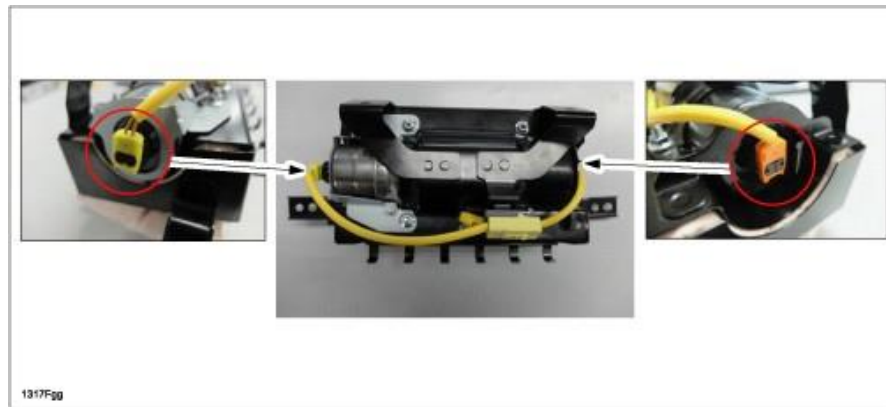

**Air Bag Module Reinstallation:**

1. Install the passenger-side air bag module according to the instructions on MGSS. (see Mazda6 PASSENGER-SIDE AIR BAG MODULE REMOVAL/INSTALLATION)
2. Reconnect the negative battery cable.
3. Turn the ignition switch to the ON position.
4. Verify that the air bag system warning light illuminates for approx. 6 sec., then goes out.

**NOTE:** If the air bag system warning light does not operate in the manner described above, there is a malfunction in the system. Inspect the system following the on-board diagnostic system procedure on MGSS (Restraints section).

5. Re-enter the customer's preset radio stations.
6. Proceed to "C. CAMPAIGN LABEL INSTALLATION".

**2007-2012 CX-7, 2007-2013 CX-9, 2009-2013 MAZDA6 - PASSENGER AIR BAG  
SAFETY RECALL 1317F**

**C. CAMPAIGN LABEL INSTALLATION**

1. Fill out a blue “Campaign Label” (9999-95-065A-06) with Campaign No: “1317F”, your dealer code, today’s date.

1326b

**CAMPAIGN LABEL**

CAMPAIGN NO: \_\_\_\_\_

DEALER CODE: \_\_\_\_\_

DATE:        /    /

P/N 9999-95-065A-06

2. Affix it to the hood or bulkhead as shown:

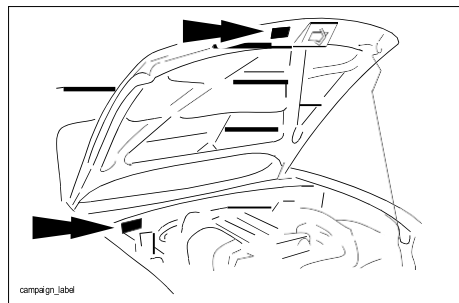

3. Return the vehicle to customer.