

## IMPORTANT UPDATE

### TECHNICAL INSTRUCTIONS

FOR

SAFETY RECALL J0K

VACUUM PUMP

CERTAIN 2018 CAMRY

**May 7<sup>th</sup> 2018: Update to thread adhesive and application**

The repair quality of covered vehicles is extremely important to Toyota. All dealership technicians performing this recall are required to successfully complete the most current version of the E-Learning course "Safety Recall and Service Campaign Essentials". To ensure that all vehicles have the repair performed correctly; technicians performing this recall repair are required to currently hold at least one of the following certification levels:

- Certified Technician (Engine)
- Expert Technician (Engine)
- Master Technician
- Master Diagnostic Technician

It is the dealership's responsibility to select technicians with the above certification level or greater to perform this recall repair. Carefully review your resources, the technician skill level, and ability before assigning technicians to this repair. It is important to consider technician days off and vacation schedules to ensure there are properly trained technicians available to perform this repair at all times.

## I. OPERATION FLOW CHART

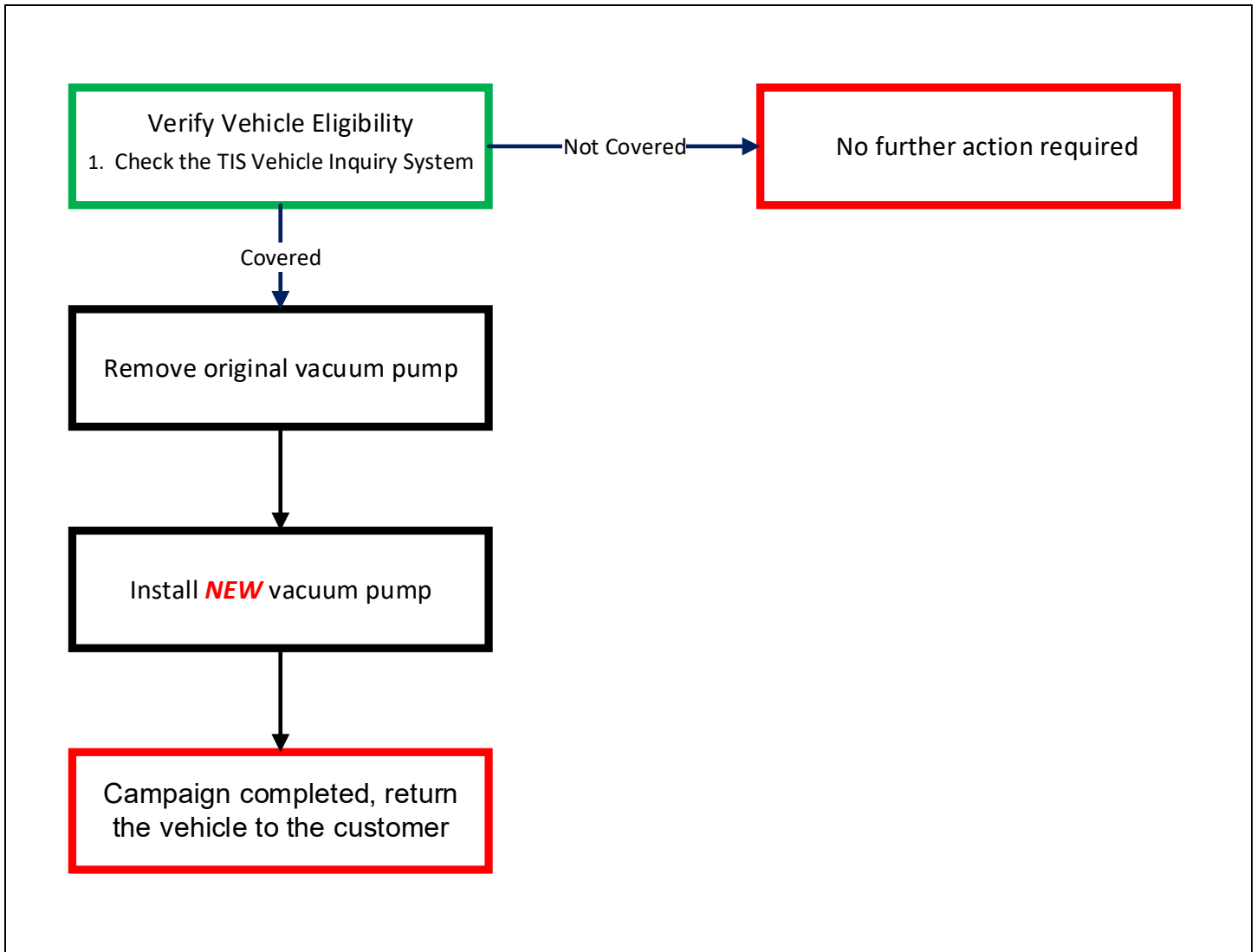

## II. IDENTIFICATION OF AFFECTED VEHICLES

- Check the TIS Vehicle Inquiry System to confirm the VIN is involved in this Safety Recall, and that it has not already been completed prior to dealer shipment or by another dealer.
- TMS warranty will not reimburse dealers for repairs completed on vehicles that are not affected or were completed by another dealer.

## III. PREPARATION

### A. PARTS

Part Number	Part Description	Quantity
29300-0P011	Vacuum Pump	1
22271-0P020	Throttle Body Gasket	1
90105-A0127	Bolt, Flange	3

## B. TOOLS & EQUIPMENT

- Techstream
- Standard Hand Tools
- Torque Wrench

## C. MATERIALS

- Toyota Genuine Adhesive 1324, Three Bond 1324 or equivalent

## IV. BACKGROUND

The involved vehicles are equipped with a vacuum pump assembly, which provides braking assist. A component in the vacuum pump assembly may have been manufactured incorrectly. This condition could lead to the illumination of a warning light, a warning message, an audible tone, and result in the sudden loss of braking assist. A sudden loss of braking assist while driving could increase the risk of a crash.

### VACUUM PUMP ASSEMBLY

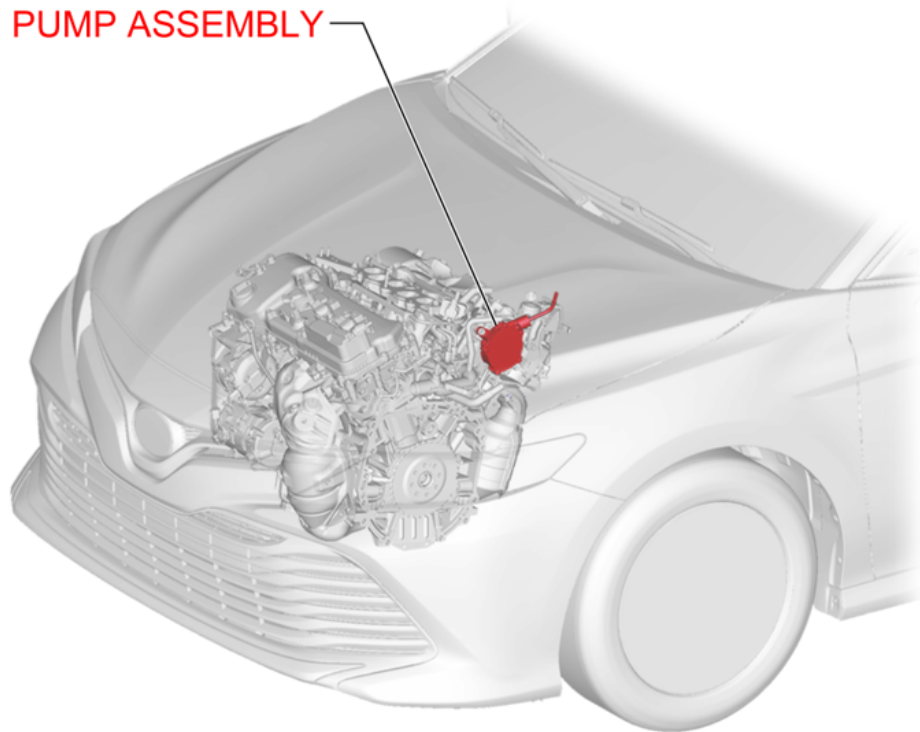

S01007bS

## V. COMPONENTS

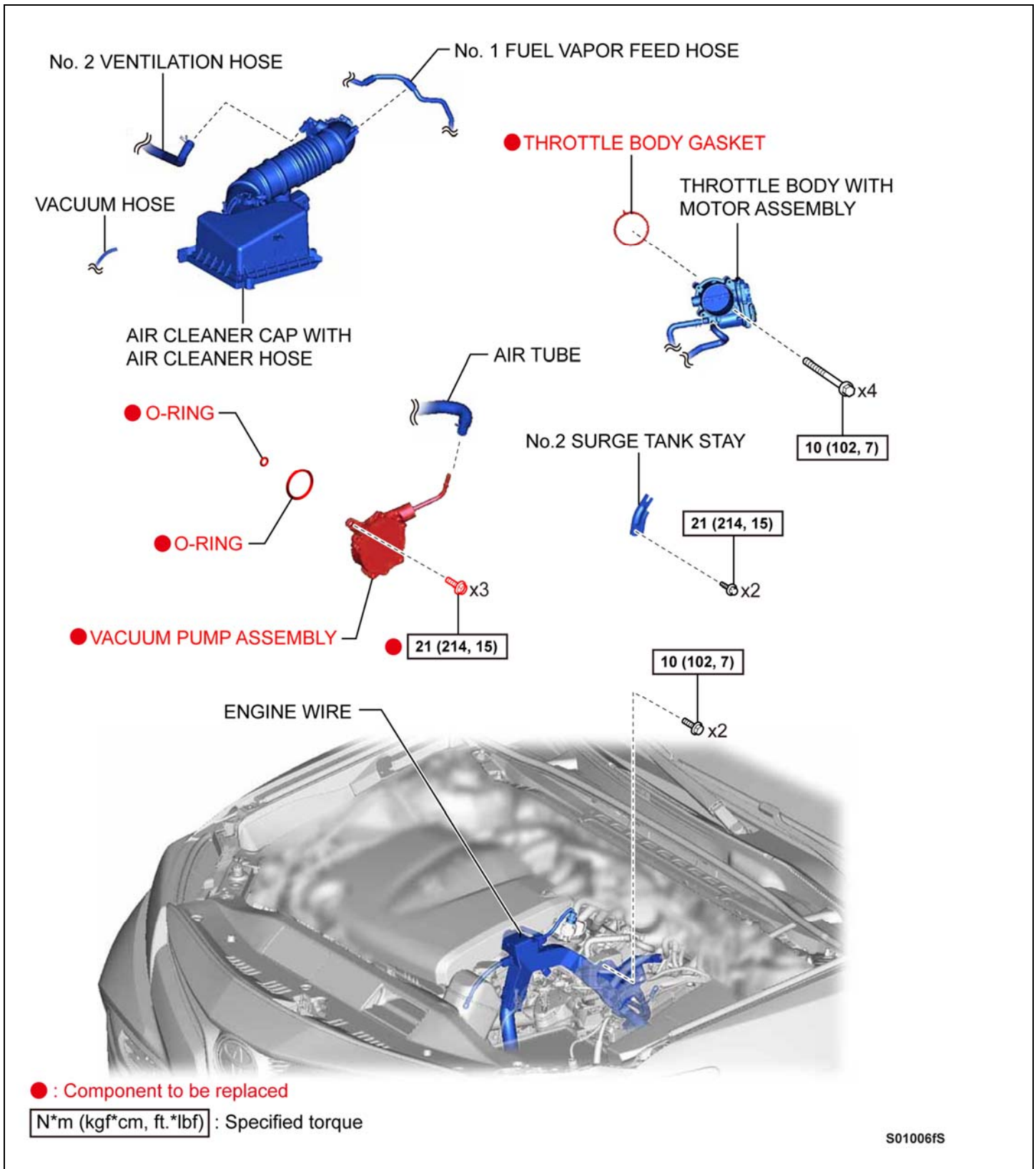

## VI. DISASSEMBLY

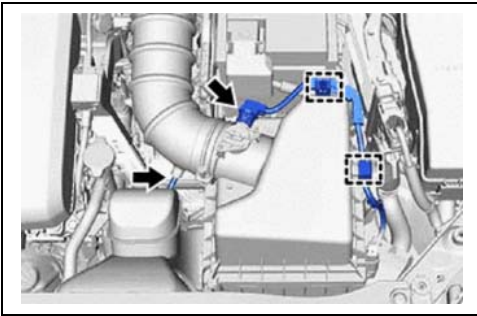

### 1. REMOVE AIR CLEANER CAP AND HOSE

- a. Unplug the mass air flow meter.
- b. Disengage the 2 wire clamps from the air cleaner cap.
- c. Disconnect the vacuum hose from the air cleaner hose.

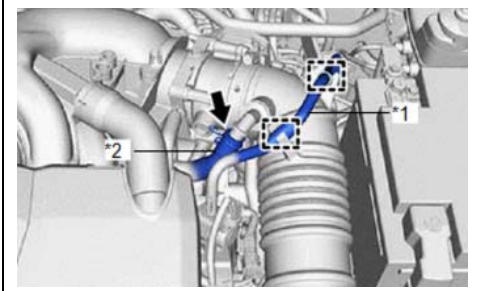

- d. Disconnect the vacuum hose from the 2 clamps.
- e. Disengage the crankcase ventilation hose from the air cleaner hose.

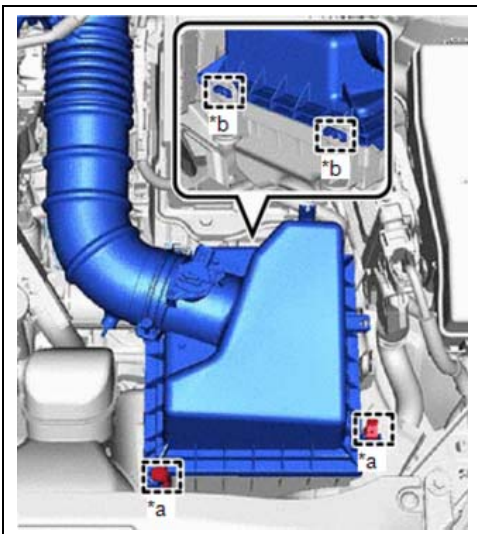

- f. Loosen the hose clamp at the throttle body.
- g. Disengage the 2 air cleaner cap clamps (\*a).
- h. Remove the air cleaner cap and hose (from the throttle body) as an assembly.

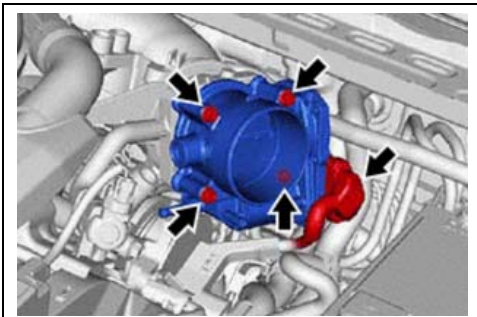

### 2. REMOVE THROTTLE BODY

- a. Disconnect the electrical connector.
- b. Remove the 4 bolts and then disengage the throttle body from the intake manifold. Lay it out of the way as to not damage the coolant hoses.

**Note:** It is not necessary to remove the coolant hoses from the throttle body.

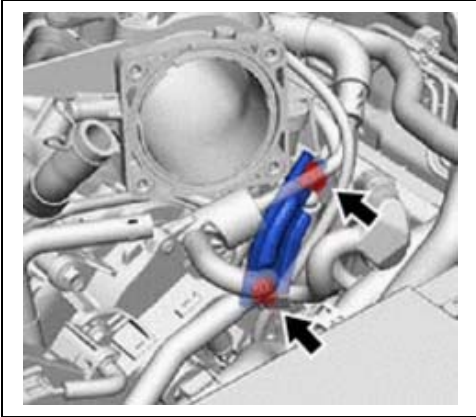

3. **REMOVE SURGE TANK STAY**
  - a. Remove the two bolts.

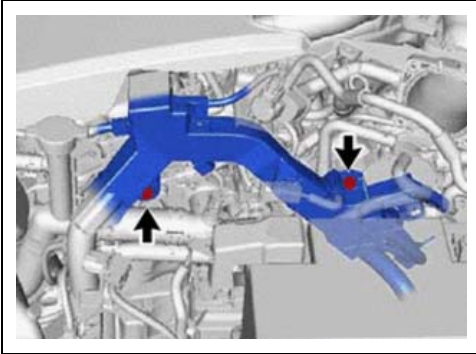

4. **LOOSEN WIRE HARNESS**
  - a. Remove the 2 bolts securing the engine wire harness.

## VII. REPLACE VACUUM PUMP

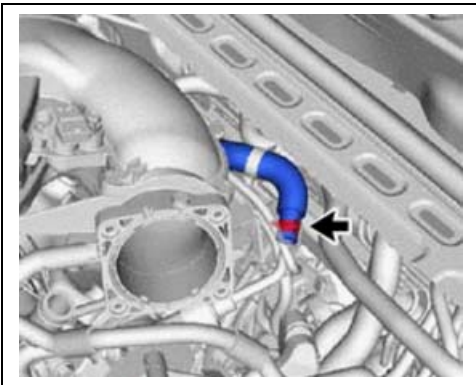

1. **REMOVE VACUUM HOSE**
  - a. Remove the clamp and hose from the vacuum pump.

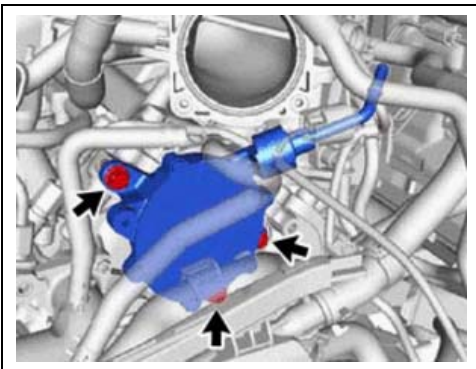

2. **REMOVE ORIGINAL VACUUM PUMP**
  - a. Remove the 3 bolts and separate the vacuum pump from the engine. There is enough slack in the wire harness to remove the pump.

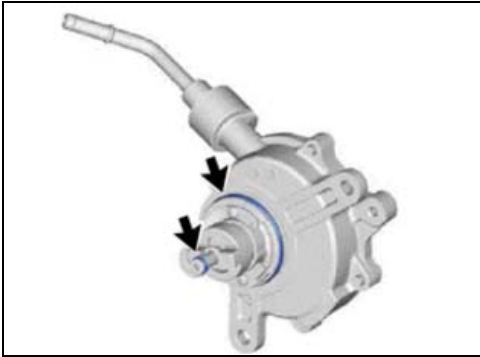

### 3. INSTALL **NEW** VACUUM PUMP

a. Apply engine oil to the 2 **NEW** O-rings.

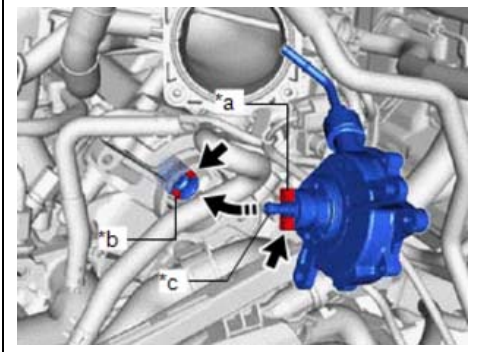

b. Install the **NEW** vacuum pump so that the oil pipe engages the hole of the camshaft and that the coupling teeth engage with the slot of the camshaft.

*a	Coupling Teeth
*b	Groove
*c	Oil Pipe

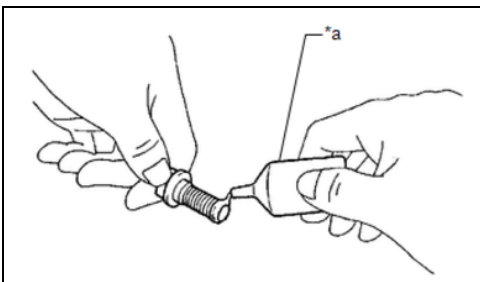

c. Apply sealant to 3 **NEW** pump housing bolts.

**Standard: Toyota Genuine Adhesive 1324, Three Bond 1324 or equivalent.**

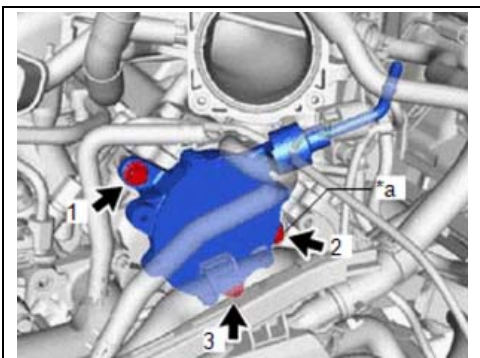

d. Install the 3 **NEW** bolts with adhesive applied.

**Torque: 15 lbf.ft {21 N·m, 214 kgf·cm}**

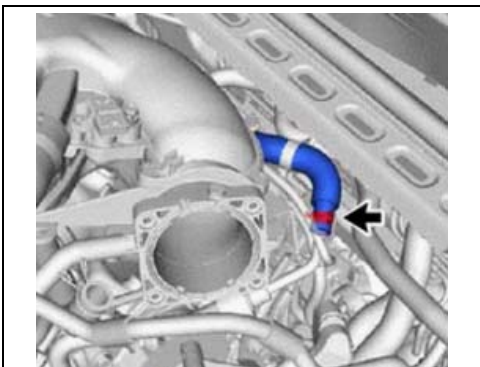

e. Connect the hose to the vacuum pump and secure the clamp.

## VIII. REASSEMBLY

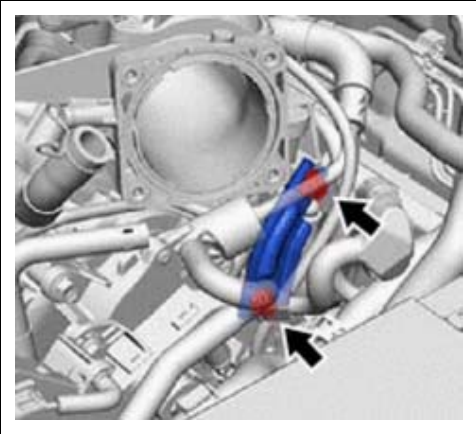

### 1. INSTALL SURGE TANK STAY

- Install the two bolts.

**Torque: 15 lbf.ft {21 N·m, 214 kgf·cm}**

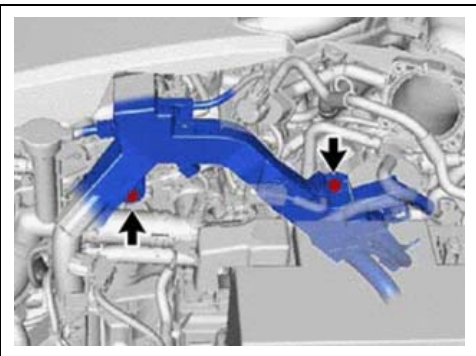

### 2. ATTACH WIRE HARNESS

- Secure the engine wire harness with 2 bolts

**Torque: 7 lbf.ft {10 N·m, 102 kgf·cm}**

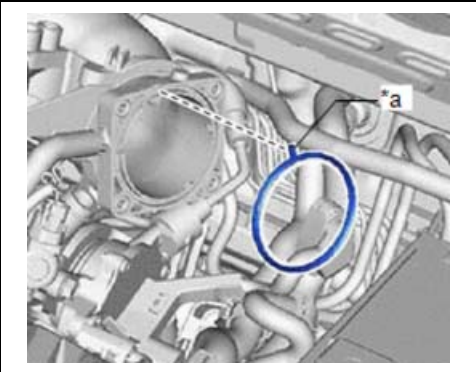

### 3. INSTALL THROTTLE BODY

- Remove the original throttle body gasket and install a **NEW** gasket oriented as shown in the illustration.

*a	Protrusion
----	------------

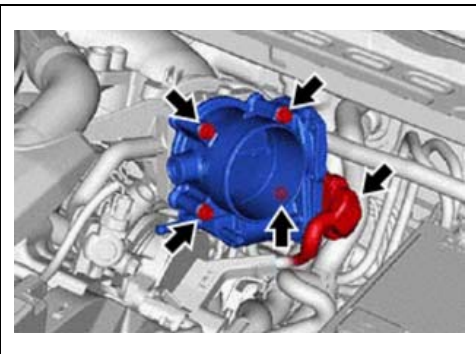

- Install the throttle body to the intake manifold with 4 bolts.

**Torque: 7 lbf.ft {10 N·m, 102 kgf·cm}**

- Connect the electrical connector.



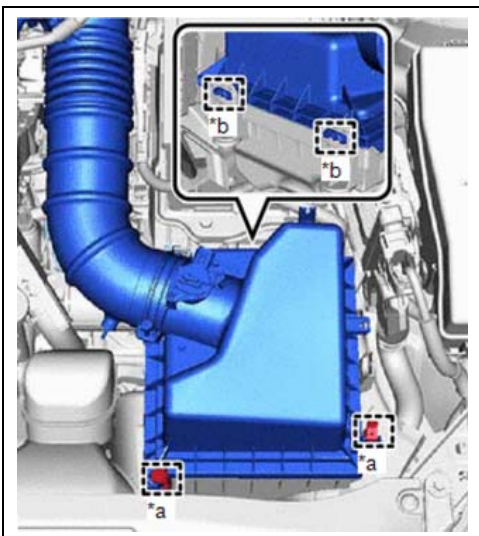

#### 4. INSTALL AIR CLEANER CAP AND HOSE

- a. Install the air cleaner hose onto the throttle body.
- b. Install the air cleaner cap onto the base.
- c. Tighten the hose clamp.
- d. Engage the 2 clamps (\*a).

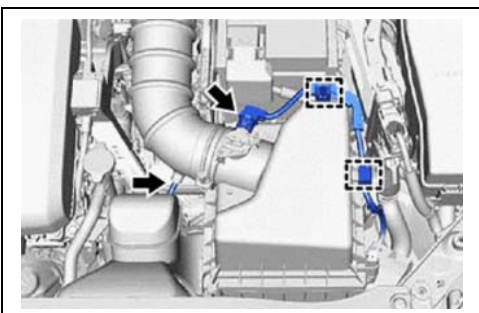

- e. Connect the mass air flow meter harness.
- f. Engage the harness into the clamps on the air cleaner cap.
- g. Connect the vacuum line to the air cleaner hose.

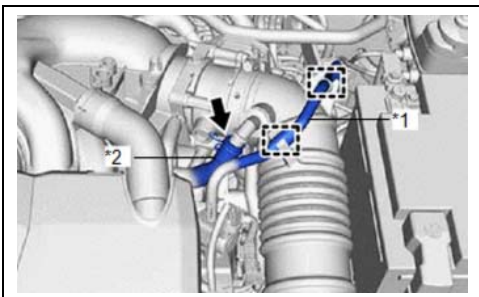

- h. Engage the hose into the 2 clamps.
- i. Connect the crankcase ventilation hose to the air cleaner hose.

### ◀ VERIFY REPAIR QUALITY ▶

1. Confirm proper operation of the power assist brakes
2. Confirm there are no oil leaks
3. Confirm there are no warning lights illuminated

If you have any questions regarding this update, please contact your regional representative.

## 10. APPENDIX

### A. PARTS DISPOSAL

As required by Federal Regulations, please make sure all recalled parts (original parts) removed from the vehicle are disposed of in a manner in which they will not be reused, **unless requested for parts recovery return.**

### B. CAMPAIGN DESIGNATION DECORDER

