

IMPORTANT UPDATE

TECHNICAL INSTRUCTIONS

FOR

SAFETY RECALL J0K

VACUUM PUMP

CERTAIN 2017 TACOMA

May 7th 2018: Part number list & thread sealant application updated

The repair quality of covered vehicles is extremely important to Toyota. All dealership technicians performing this recall are required to successfully complete the most current version of the E-Learning course "Safety Recall and Service Campaign Essentials". To ensure that all vehicles have the repair performed correctly; technicians performing this recall repair are required to currently hold at least one of the following certification levels:

- Certified Technician (Engine)
- Expert Technician (Engine)
- Master Technician
- Master Diagnostic Technician

It is the dealership's responsibility to select technicians with the above certification level or greater to perform this recall repair. Carefully review your resources, the technician skill level, and ability before assigning technicians to this repair. It is important to consider technician days off and vacation schedules to ensure there are properly trained technicians available to perform this repair at all times.

I. OPERATION FLOW CHART

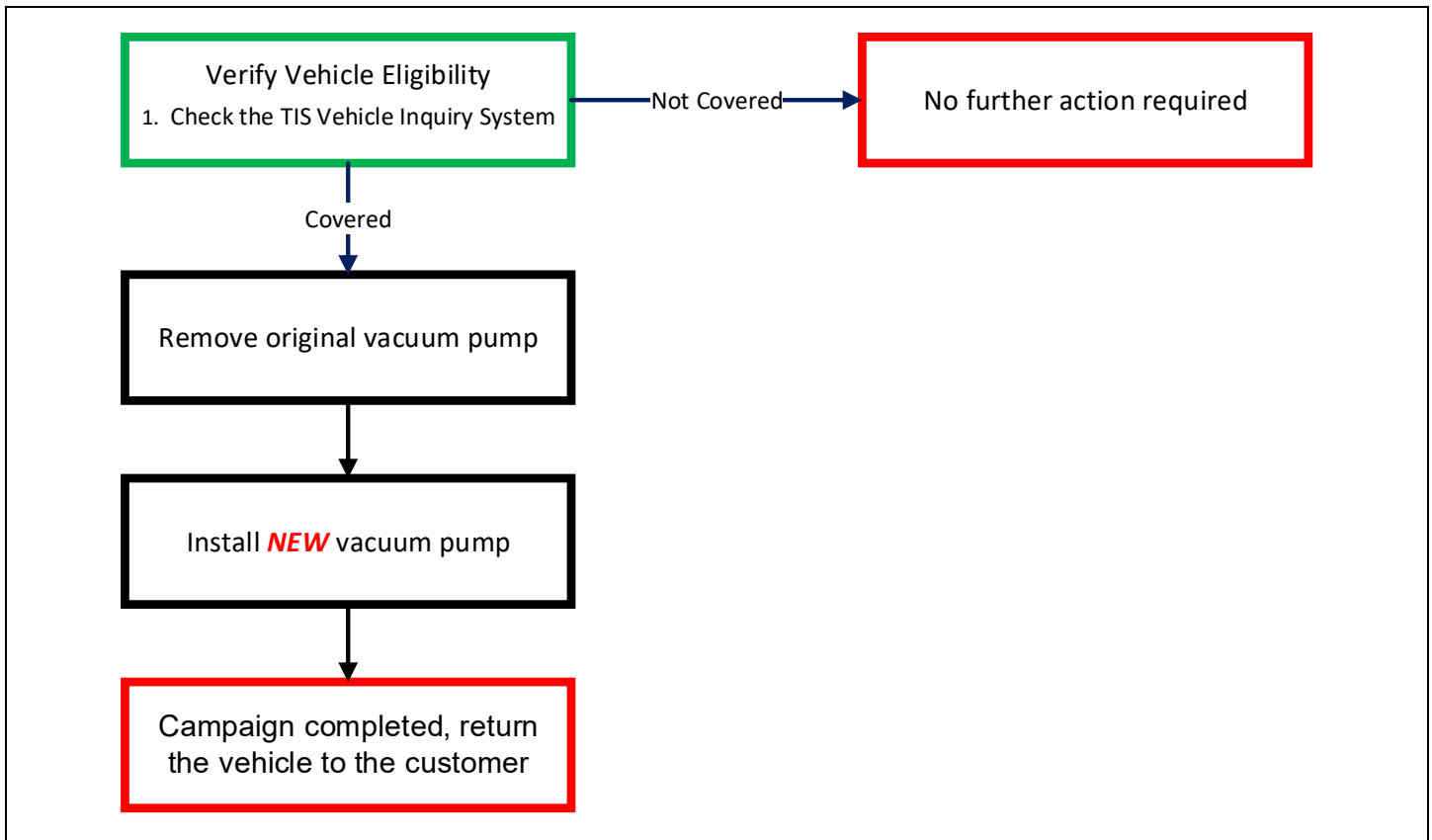

II. IDENTIFICATION OF AFFECTED VEHICLES

- Check the TIS Vehicle Inquiry System to confirm the VIN is involved in this Safety Recall, and that it has not already been completed prior to dealer shipment or by another dealer.
- TMS warranty will not reimburse dealers for repairs completed on vehicles that are not affected or were completed by another dealer.

III. PREPARATION

A. PARTS

Part Number	Part Description	Quantity
29300-0P021	Vacuum Pump	1
90105-A0127	Bolt, Flange	3

B. TOOLS & EQUIPMENT

- Techstream
- Standard Hand Tools
- Torque Wrench

C. MATERIALS

- Toyota Genuine Adhesive 1324, Three Bond 1324 or equivalent

IV. BACKGROUND

The involved vehicles are equipped with a vacuum pump assembly, which provides braking assist. A component in the vacuum pump assembly may have been manufactured incorrectly. This condition could lead to the illumination of a warning light, a warning message, an audible tone, and result in the sudden loss of braking assist. A sudden loss of braking assist while driving could increase the risk of a crash.

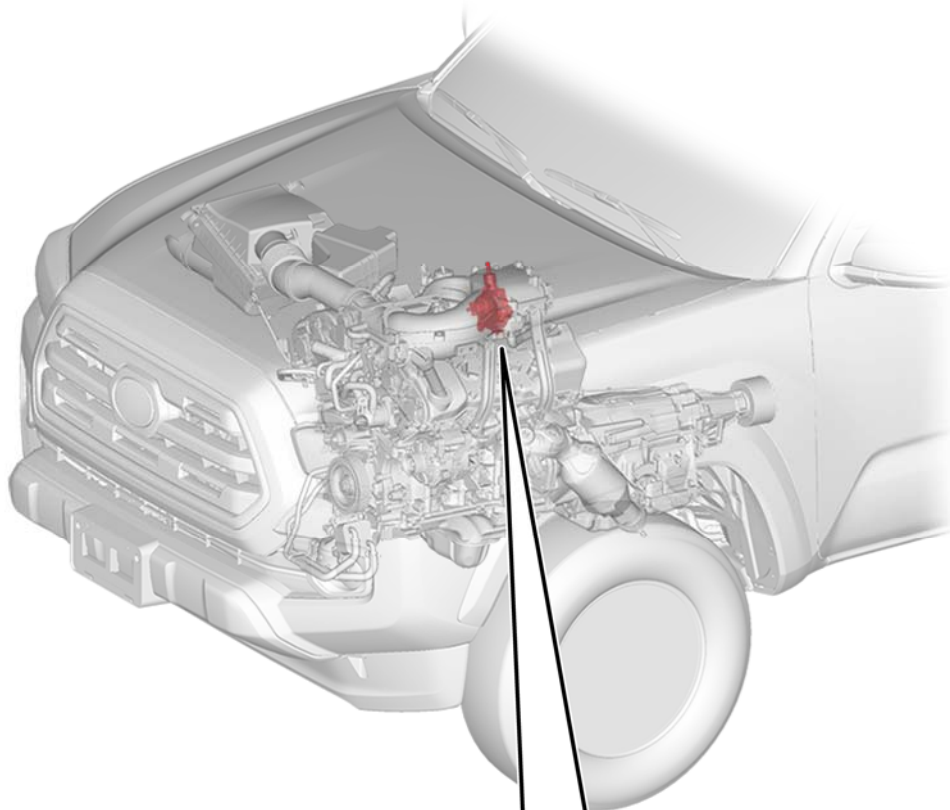

VACUUM PUMP ASSEMBLY

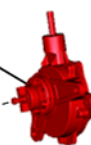
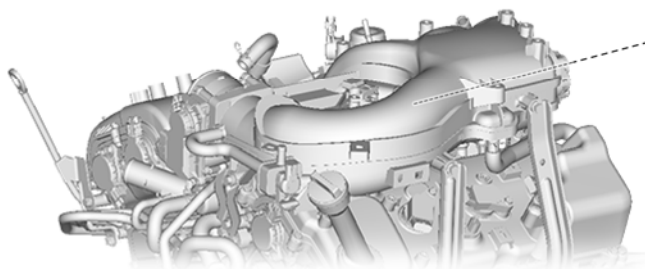

S01010bS

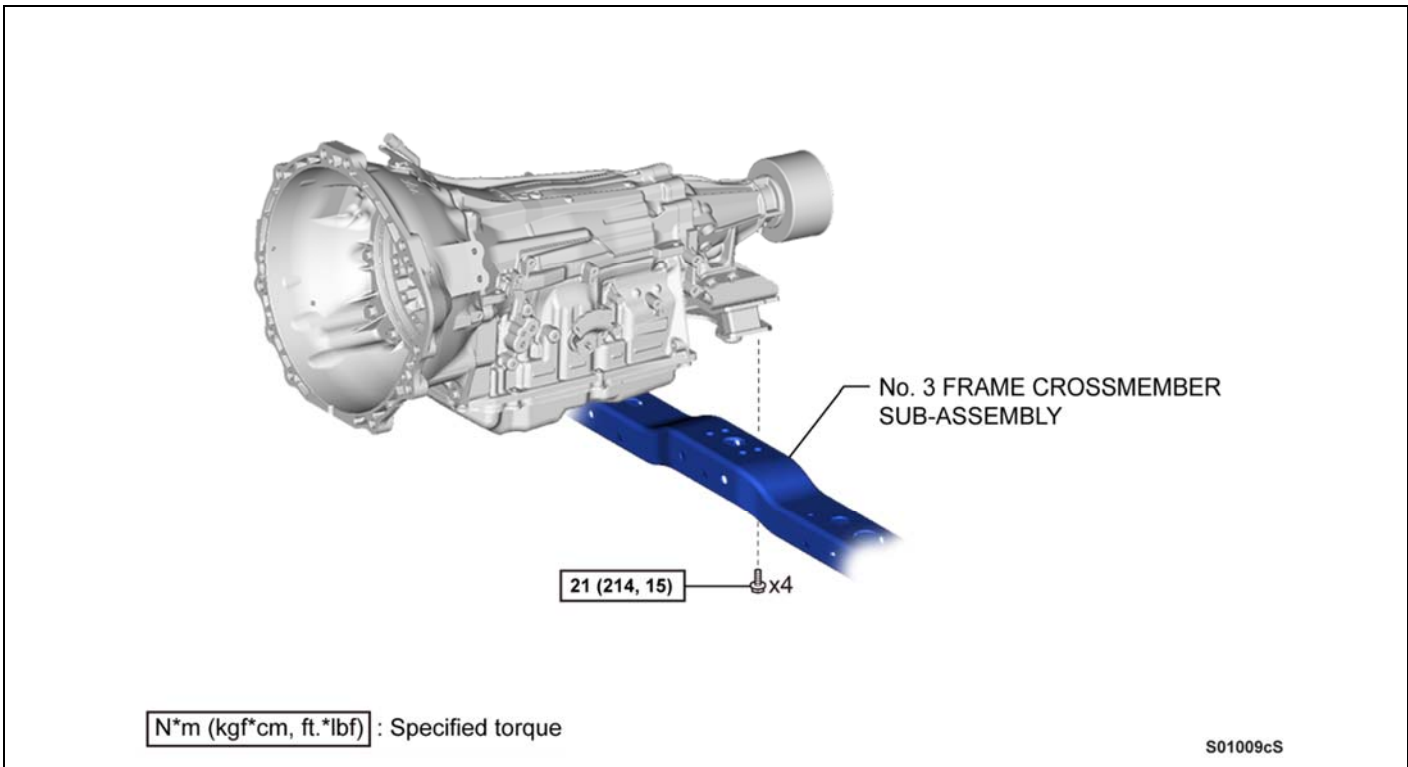
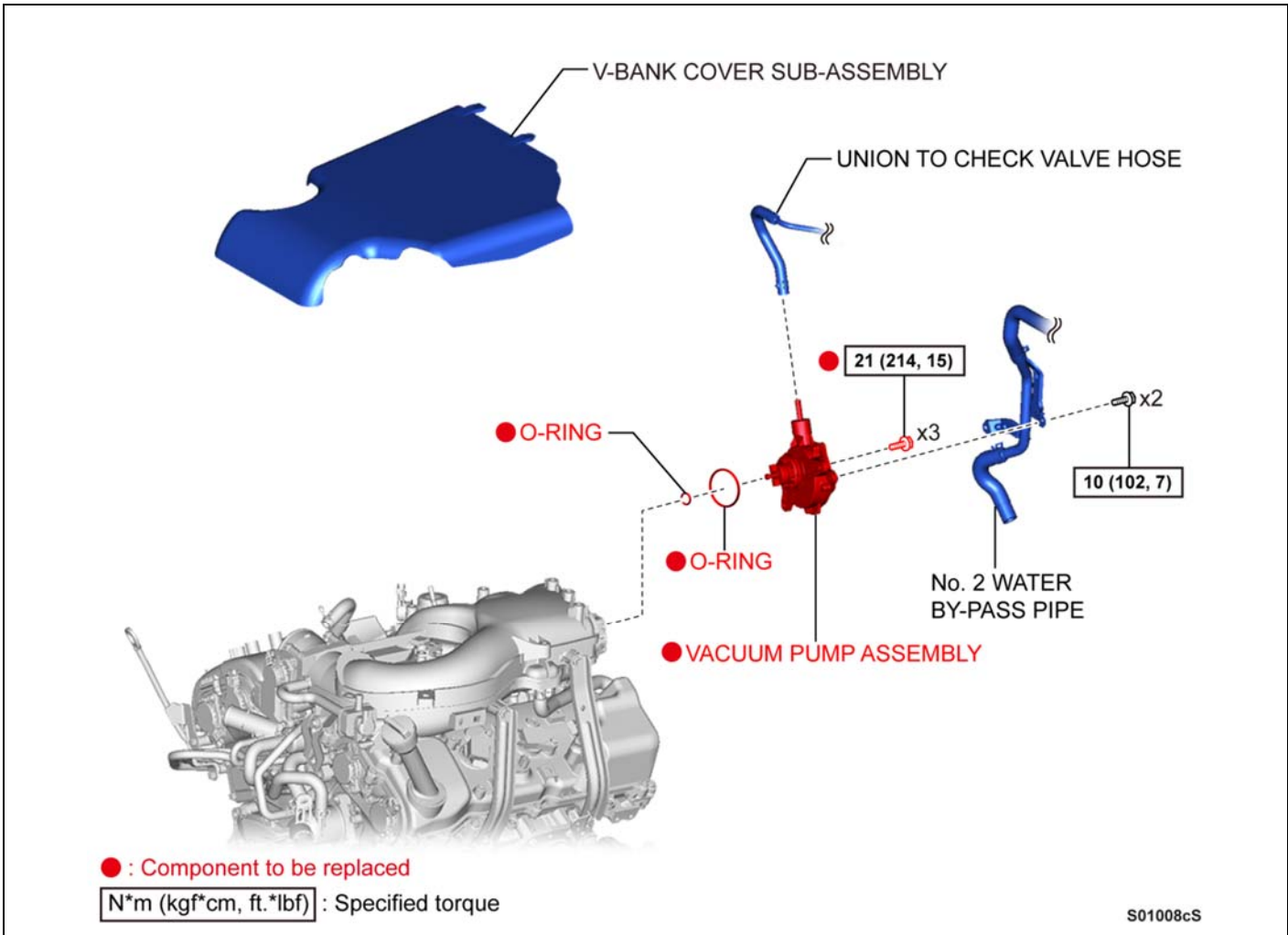

V. DISASSEMBLY



1. **REMOVE THE TRANSMISSION MOUNT BOLTS**
 - a. Remove the 4 bolts securing the transmission mount to the crossmember.

2. POSITION FLOOR JACK UNDER THE TRANSMISSION

- a. Using a rubber pad, place a floor jack under the designated lifting point.

Automatic Transmission:

4x2: Lift under the rear edge of the oil pan.

4x4: Lift under the skid plate of the transfer case

Manual Transmission:

4x2: Lift under the transmission case

4x4: Lift under the skid plate of the transfer case

Automatic transmission lift points:

4x2 Automatic



4x4 Automatic



Note: Lift only on the rear most edge of the pan. Lifting in the center of the pan may cause damage.

Manual transmission lift points:

4x2 Manual



4x4 Manual



3. LIFT TRANSMISSION

- a. Using the previously positioned floor jack, lift the transmission so that $\frac{3}{4}$ " (19mm) of clearance is achieved between the transmission mount and the crossmember.

Transmission lifting amount:

4x2 Automatic



4x4 Auto & All Manual's



Lifting the transmission more than the specified amount can cause damage.

4. INSERT BLOCKS TO SUPPORT TRANSMISSION

- a. Insert $\frac{3}{4}$ " pieces of wood between the transmission mount and crossmember to securely support the transmission.

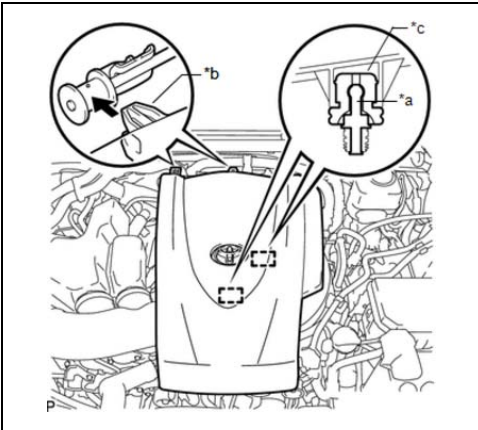

5. REMOVE V-BANK COVER

- a. Lift on the front of the cover to disengage the 2 pins.
- b. Slide the cover forward to disengage the 2 guides in the rear.

*a	Pin
*b	Guide

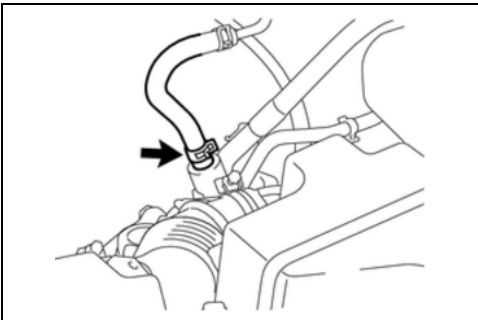

6. REMOVE UNION TO CHECK VALVE HOSE

- a. Slide the clamp upward and remove the hose from the vacuum pump.

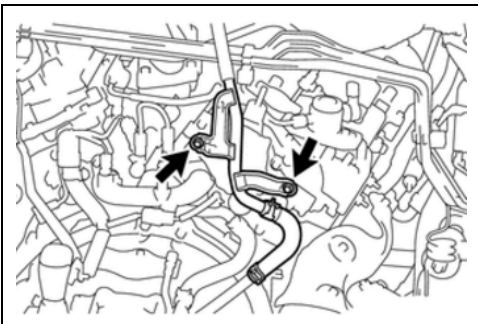

7. SEPARATE WATER BYPASS PIPE

- a. Remove the 2 bolts and reposition the pipe away from the vacuum pump.

Note: There is no need to remove the coolant hoses.

View is from the rear of the engine.



8. REMOVE VACUUM PUMP

- a. Remove the 3 bolts then carefully slide the pump rearward.

View is from the rear of the engine.

VI. INSTALLATION



1. INSTALL **NEW** VACUUM PUMP

a. Apply engine oil to the 2 **NEW** O-rings.

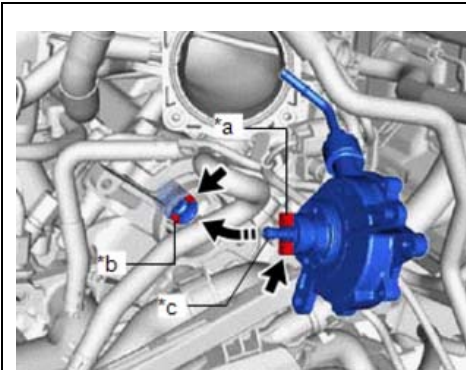

Diagram shown is not a Tacoma.

b. Install the **NEW** vacuum pump so that the oil pipe engages the hole of the camshaft and that the coupling teeth engage with the slot of the camshaft.

*a	Coupling Teeth
*b	Groove
*c	Oil Pipe



Be careful not to damage the O-ring during installation.

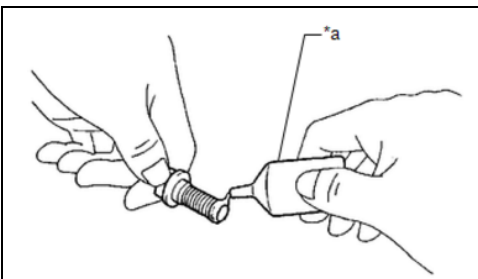

c. Apply sealant to all 3 **NEW** pump housing bolts.

Standard: Toyota Genuine Adhesive 1324, Three Bond 1324 or equivalent.

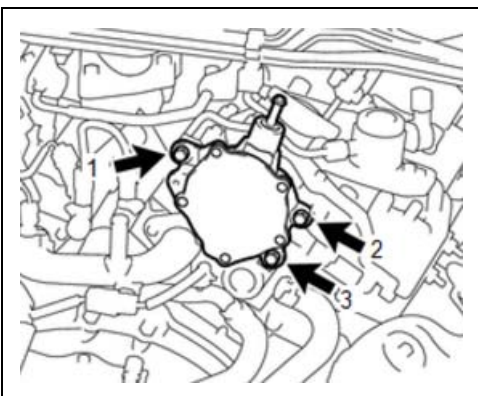

d. Install the 3 **NEW** bolts with adhesive applied.

e. Torque the bolts in sequence shown.

Torque: 15 lbf.ft {21 N·m, 214 kgf·cm}

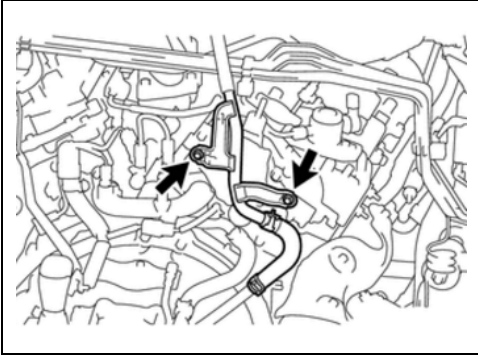

2. INSTALL WATER BYPASS PIPE

- a. Install the 2 bolts.

Torque: 7 lbf.ft {10 N·m, 102 kgf·cm}

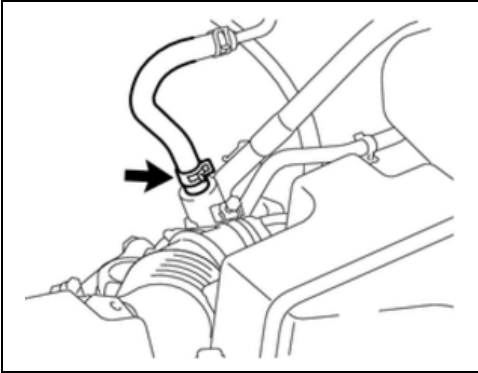

3. INSTALL UNION TO CHECK VALVE HOSE

- a. Slide the hose over the vacuum pipe.
- b. Position the clamp properly.



4. INSTALL V-BANK COVER

- a. Engage the 2 guides in the rear and then push the top of the cover to engage the 2 pins in the center.

*a	Pin
*b	Guide



5. INSTALL TRANSMISSION MOUNT BOLTS

- a. Raise the transmission enough to remove the wood blocks between the mount and crossmember.
- b. While lowering the transmission, use a large screwdriver to guide the alignment pin of the mount into the crossmember, if needed.
- c. Install the 4 mount bolts.

Torque 15 lbf.ft {21 N·m, 214 kgf·cm}

◀ VERIFY REPAIR QUALITY ▶

1. Confirm proper operation of the power assist brakes
2. Confirm there are no oil leaks
3. Confirm there are no warning lights illuminated

If you have any questions regarding this update, please contact your regional representative.

10. APPENDIX

A. PARTS DISPOSAL

As required by Federal Regulations, please make sure all recalled parts (original parts) removed from the vehicle are disposed of in a manner in which they will not be reused, **unless requested for parts recovery return.**

B. CAMPAIGN DESIGNATION DECORDER

