

TECHNICAL INSTRUCTIONS

FOR

SAFETY RECALL JLD

VACUUM PUMP

CERTAIN 2017 RX 350

The repair quality of covered vehicles is extremely important to Lexus. All dealership technicians performing this recall are required to successfully complete the most current version of the E-Learning course “Safety Recall and Service Campaign Essentials”. To ensure that all vehicles have the repair performed correctly; technicians performing this recall repair are required to currently hold at least one of the following certification levels:

- Certified
- Senior
- Master

It is the dealership’s responsibility to select technicians with the above certification level or greater to perform this recall repair. Carefully review your resources, the technician skill level, and ability before assigning technicians to this repair. It is important to consider technician days off and vacation schedules to ensure there are properly trained technicians available to perform this repair at all times.

I. OPERATION FLOW CHART

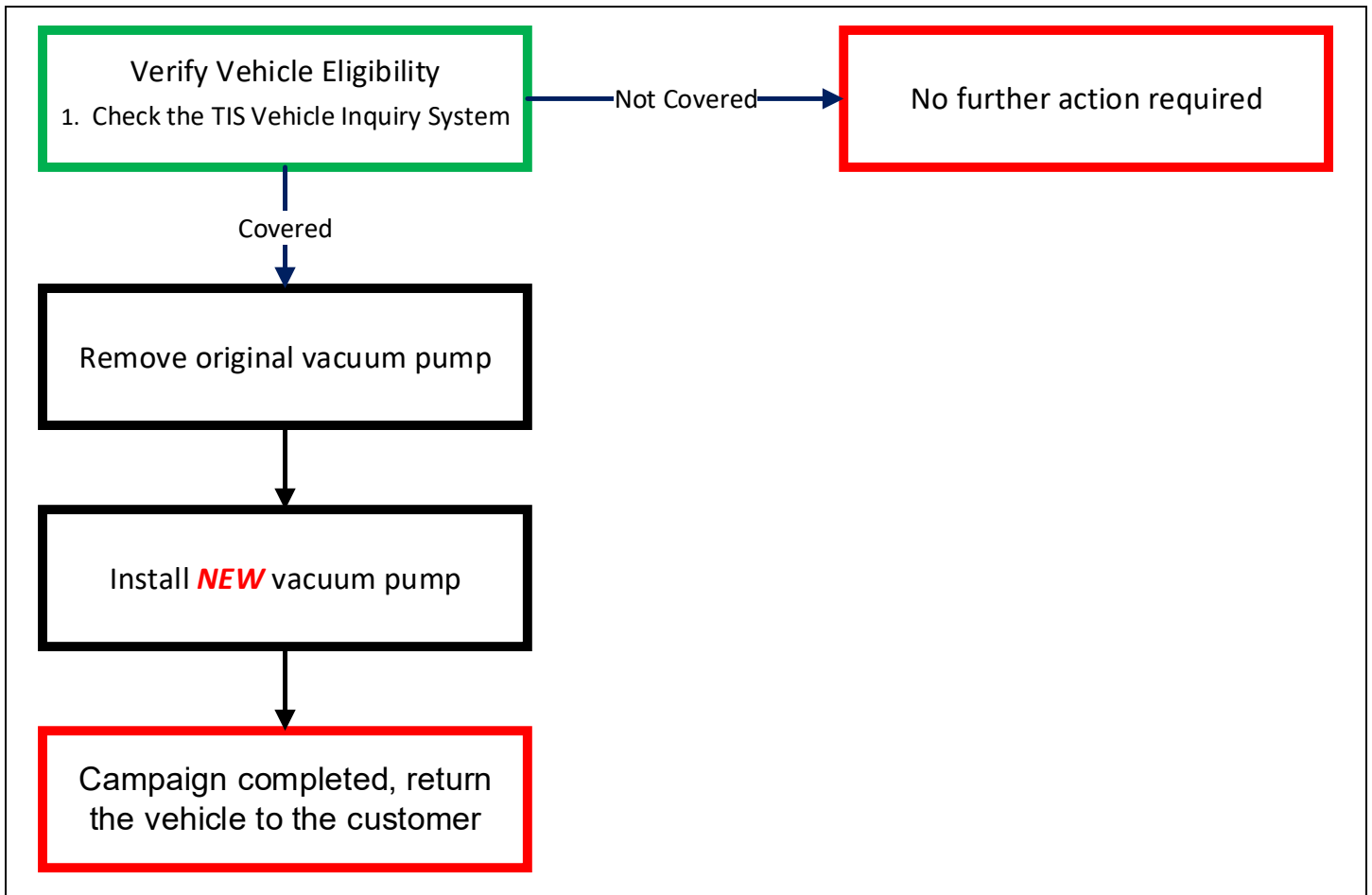

II. IDENTIFICATION OF AFFECTED VEHICLES

- Check the TIS Vehicle Inquiry System to confirm the VIN is involved in this Safety Recall, and that it has not already been completed prior to dealer shipment or by another dealer.
- TMS warranty will not reimburse dealers for repairs completed on vehicles that are not affected or were completed by another dealer.

III. PREPARATION

A. PARTS

Part Number	Part Description	Quantity
29300-0P011	Vacuum Pump	1
22271-0P020	Throttle Body Gasket	1
90105-A0127	Bolt, Flange	3

B. TOOLS & EQUIPMENT

- Techstream
- Standard Hand Tools
- Torque Wrench

C. MATERIALS

- Toyota Genuine Adhesive 1324, Three Bond 1324 or equivalent thread sealer (not thread locker)

IV. BACKGROUND

The involved vehicles are equipped with a vacuum pump assembly, which provides braking assist. A component in the vacuum pump assembly may have been manufactured incorrectly. This condition could lead to the illumination of a warning light, a warning message, an audible tone, and result in the sudden loss of braking assist. A sudden loss of braking assist while driving could increase the risk of a crash.

VACUUM PUMP ASSEMBLY

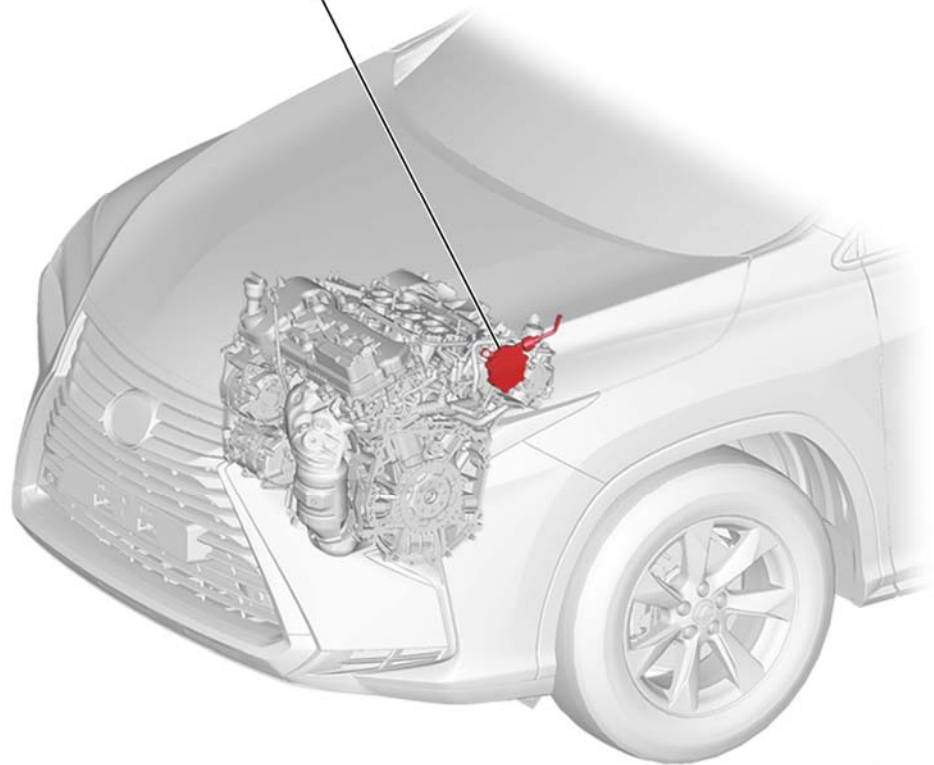

S01003bS

V. COMPONENTS

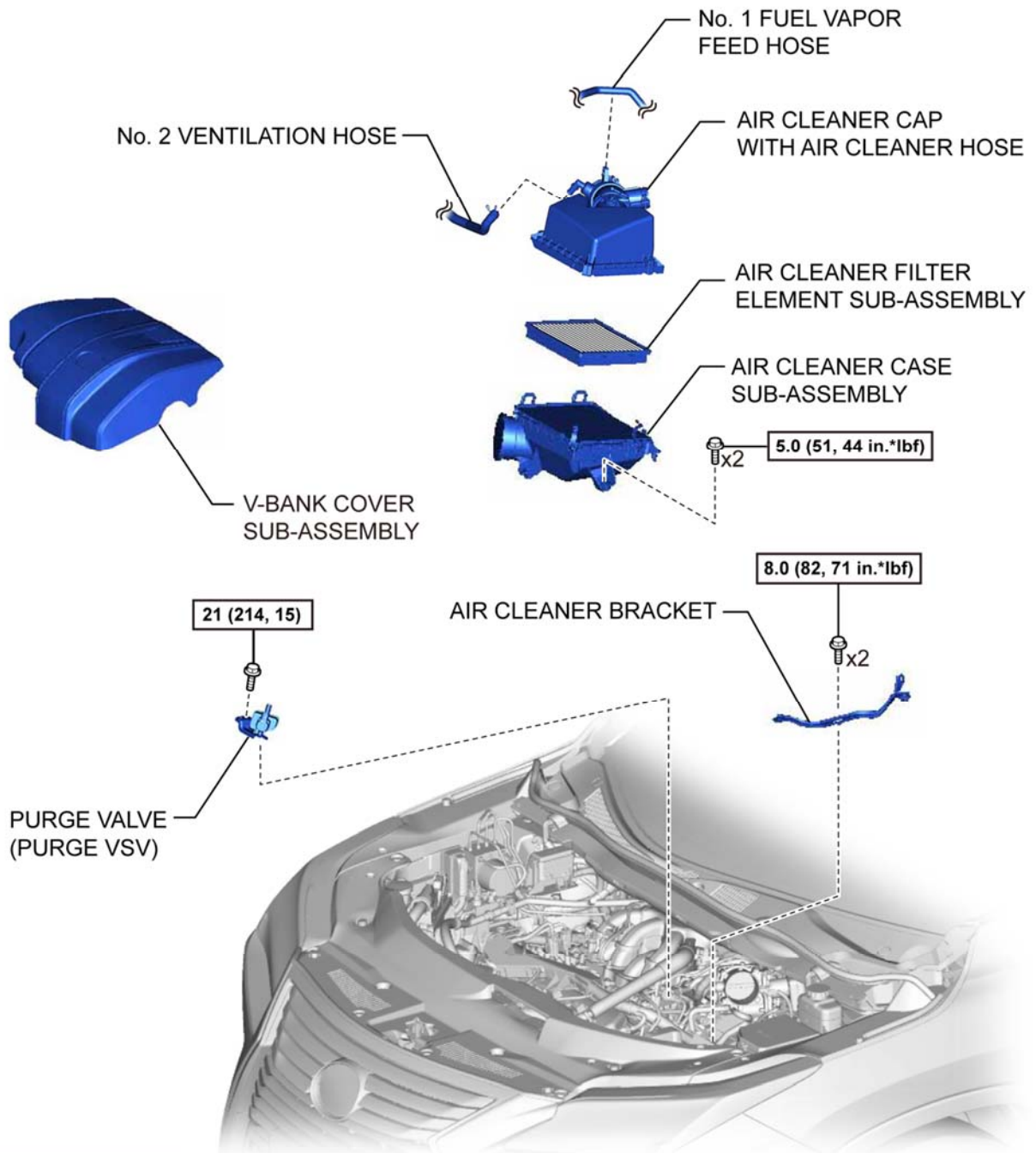

N*m (kgf*cm, ft.*lbf) : Specified torque

S01001cS

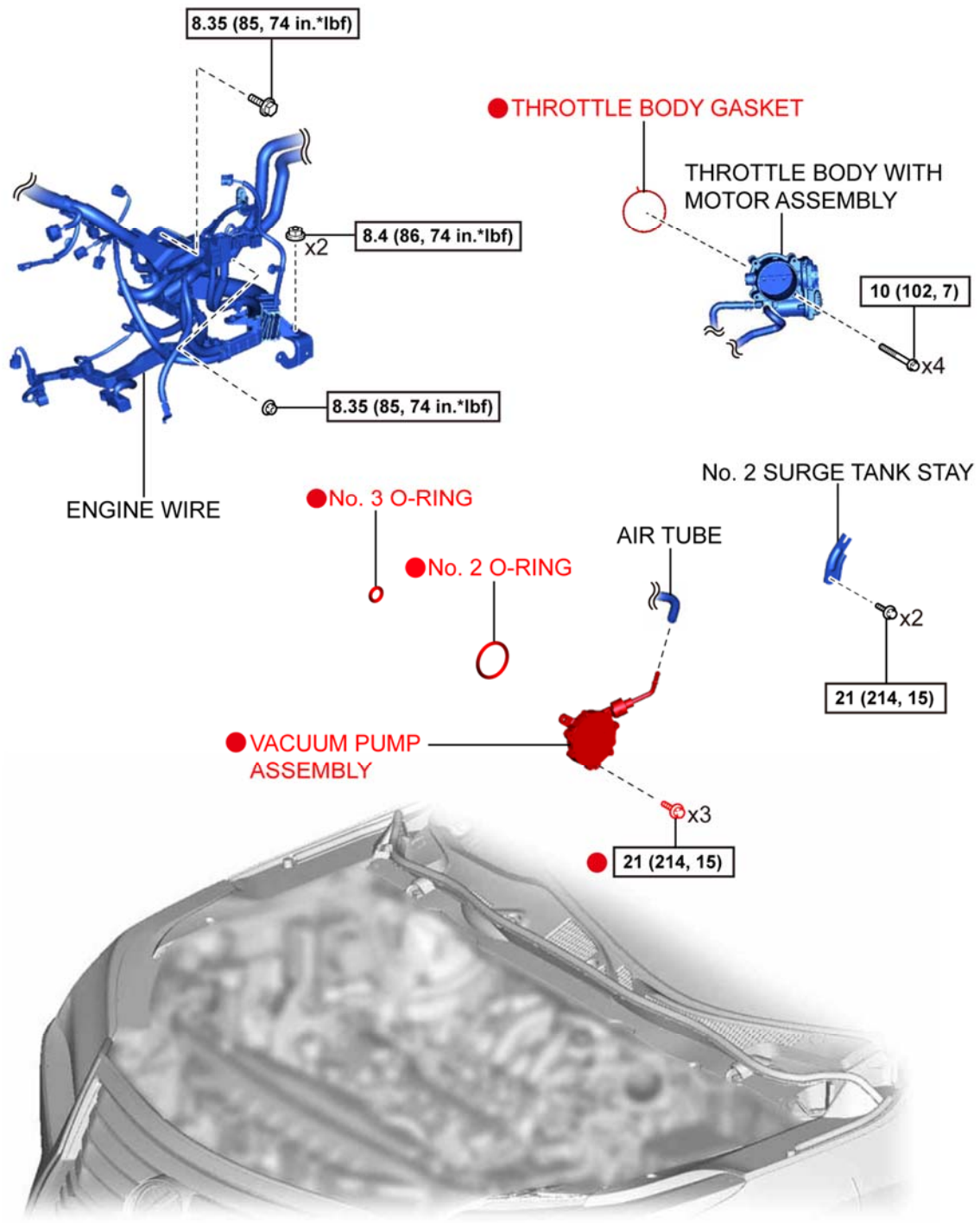

● : Component to be replaced

N*m (kgf*cm, ft.*lbf) : Specified torque

S01002eS

VI. DISASSEMBLY

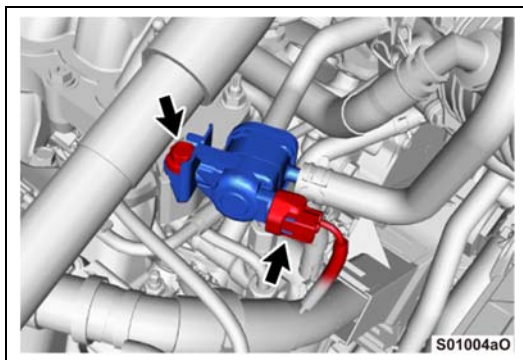

1. UNBOLT PURGE VSV

- Remove the V-bank cover.
- Unplug the electrical connector from the Purge VSV.
- Unbolt the Purge VSV from the intake plenum.



Unbolting the Purge VSV will create more working room while removing the vacuum pump, and prevent breakage to the plastic VSV mount.

Note: Do not disconnect the hoses from the VSV.

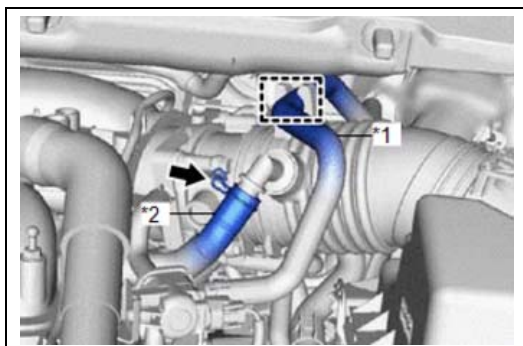

2. REMOVE AIR CLEANER CAP

- Unplug the mass air flow meter.
- Disengage the wire harness clamp.
- Disengage the fuel Vapor hose (*1) from the clamp.
- Disengage the ventilation hose (*2).
- Loosen the hose clamp from the throttle body.
- Disengage the 2 air cleaner clamps (*a)
- Disengage the 2 guides (*b) to remove the air cleaner cap.
- Remove the air cleaner filter element.
- Remove the 2 bolts from the air cleaner case.
- Remove the air cleaner case.

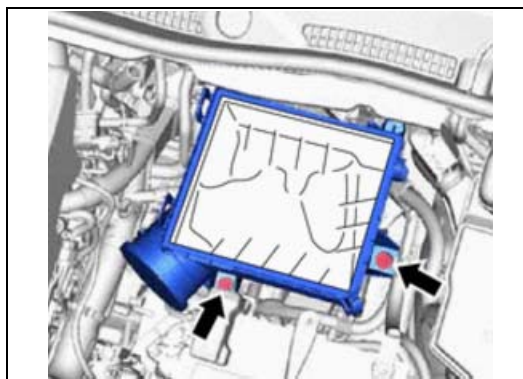
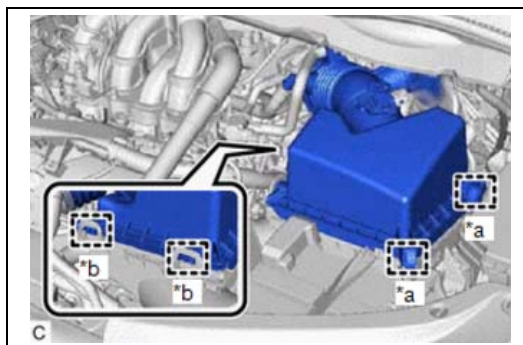

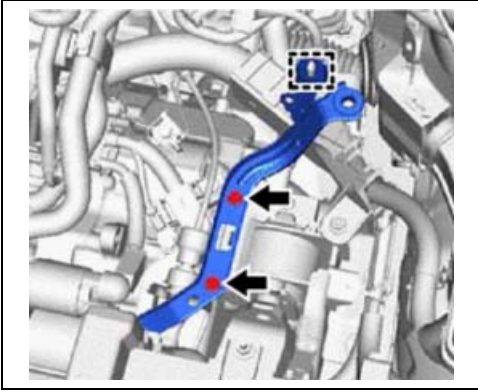

- k. Unclip the harness connector from the air cleaner case bracket.
- l. Remove the 2 bolts from the air cleaner case bracket.

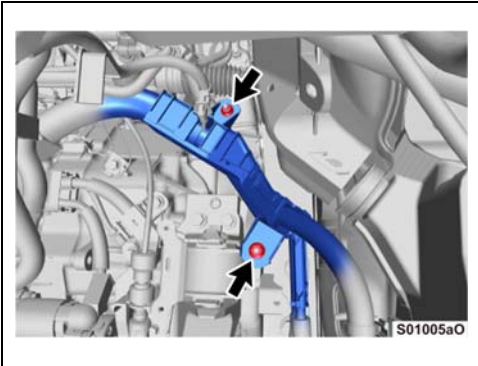

3. LOOSEN ENGINE MAIN HARNESS

- a. Remove the 2 nuts from the engine main harness.
- b. Lift the engine main harness from the studs.

STOP Unbolting the engine main harness will create more pump clearance from the wire harness, making it possible to access the mounting bolts and remove the pump from the engine.

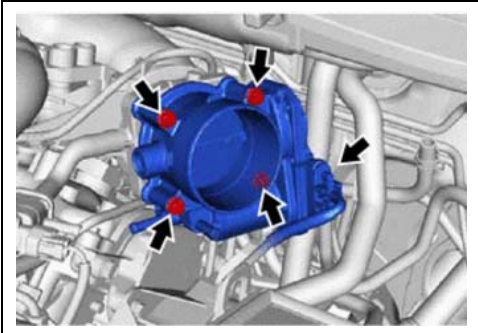

4. REMOVE THROTTLE BODY

- a. Disconnect electrical connector from throttle body.
- b. Remove the 4 bolts and separate the throttle body.

Note: DO NOT remove the coolant hoses from the throttle body. There is enough room to lay the throttle body out of the way to access the vacuum pump with the coolant hoses still attached.

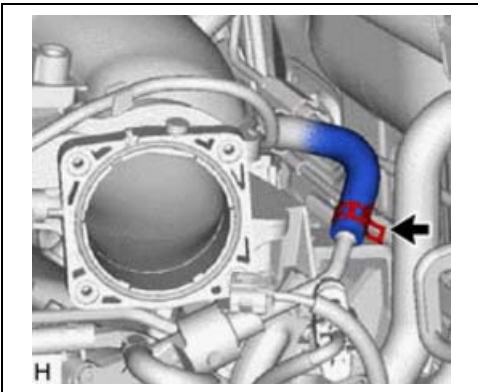

5. DISCONNECT AIR TUBE

- a. Slide the clamp and disconnect the air tube from the vacuum pump.

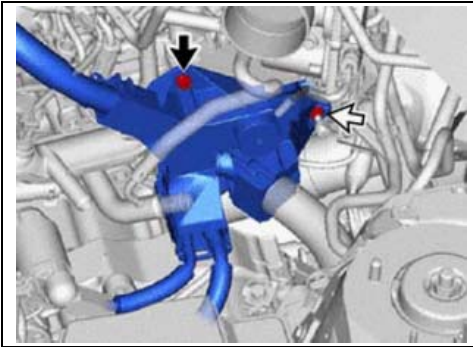

6. LOOSEN WIRE HARNESS

- a. Remove the bolt and nut from the wire harness bracket.

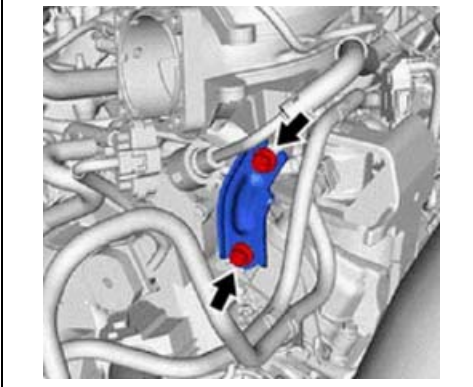

7. REMOVE SURGE TANK STAY

- a. Remove the 2 bolts.

VII. REPLACE VACUUM PUMP

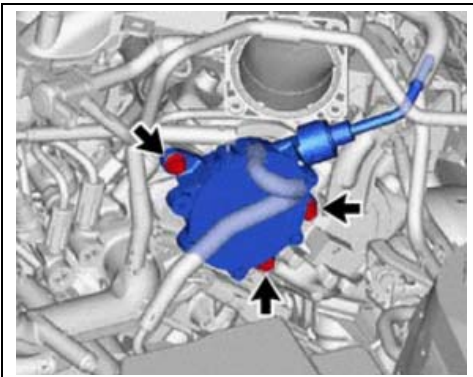

1. REMOVE VACUUM PUMP

- a. Remove 3 bolts.
- b. Pull outward on the pump to separate it from the engine.

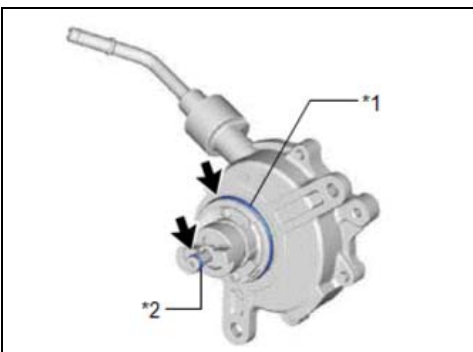

2. PREPARE **NEW** VACUUM PUMP

- a. Apply engine oil to the **NEW** O-Rings (*1 & *2) on the **NEW** vacuum pump.

Note: The **NEW** O-Rings come installed on the **NEW** vacuum pump. They are not ordered separately.

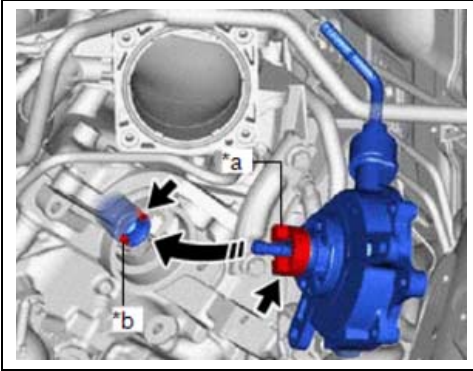

3. INSTALL *NEW* VACUUM PUMP

- a. Position the Coupling Teeth (*a) of the *NEW* vacuum pump to align with the Groove (*b) in the end of the camshaft.
- b. Slide the *NEW* vacuum pump onto the engine.

*a	Coupling Teeth
*b	Groove

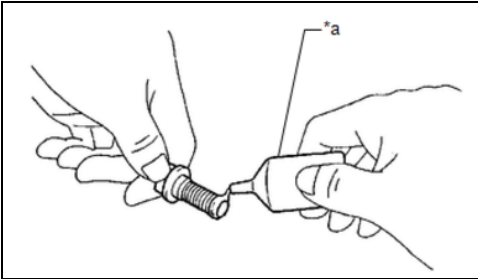

- c. Apply sealant to 1 *NEW* pump housing bolt.

Standard: Toyota Genuine Adhesive 1324, Three Bond 1324 or equivalent thread sealer (not thread locker).

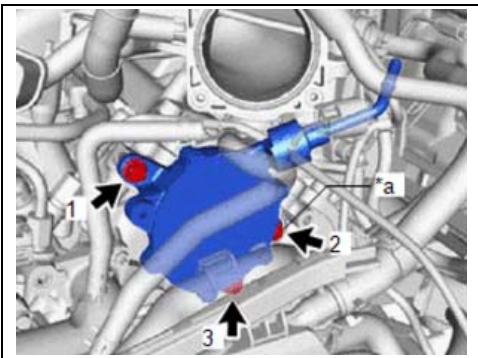

- d. Install the *NEW* bolt with adhesive applied in position #2.
- e. Install the 2 *NEW* bolts without adhesive applied in positions #1 and #3.

Torque: 15 lbf.ft {21 N·m, 214 kgf·cm}

*a: Pump housing bolt with adhesive applied

VIII. REASSEMBLY

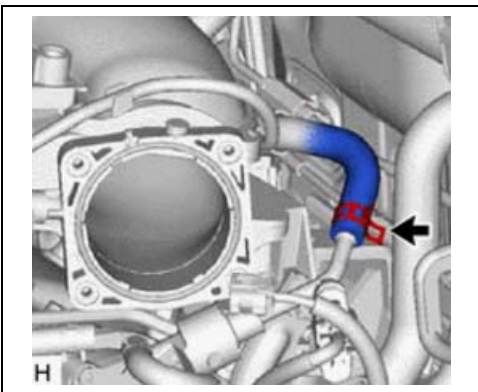

1. CONNECT AIR TUBE

- a. Slide the air tube and clamp onto the vacuum pump.

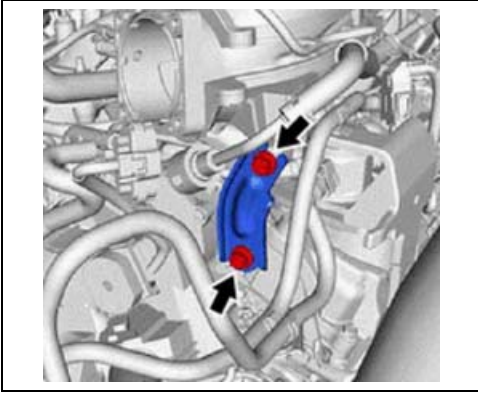

2. INSTALL SURGE TANK STAY

- a. Install the 2 bolts.

Torque: 15 lbf.ft {21 N·m, 214 kgf·cm}

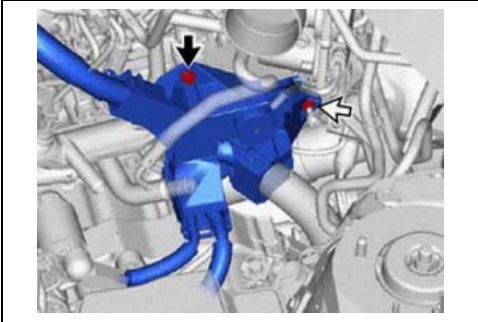

3. SECURE WIRE HARNESS

- a. Install the bolt and nut on the wire harness bracket.

Torque: 74 lbf.in {8.35 N·m, 85 kgf·cm}

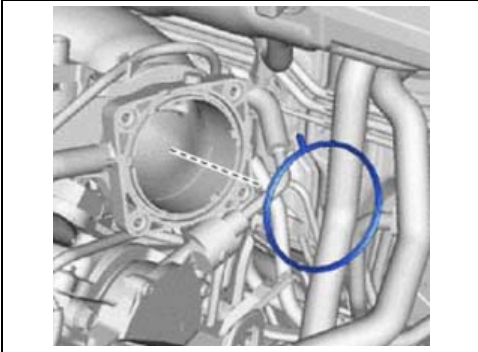

4. REPLACE THROTTLE BODY GASKET

- a. Remove the original throttle body gasket, noticing the location of the locating tab.
- b. Install a **NEW** throttle body gasket, properly orientating the locating tab.

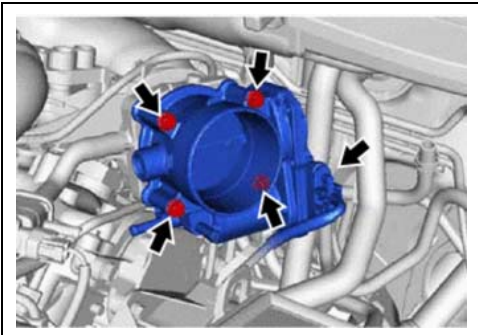

5. INSTALL THROTTLE BODY

- a. Install the throttle body with 4 bolts.

Torque: 88 lbf.in {10 N·m, 102 kgf·cm}

- b. Connect electrical connector to the throttle body.

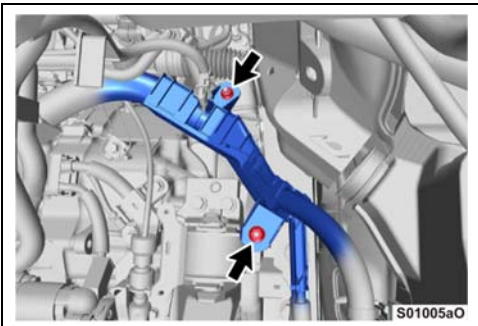

6. INSTALL ENGINE MAIN HARNESS

- a. Install the 2 nuts on the engine main harness.

Torque: 74 lbf.in {8.4 N·m, 85 kgf·cm}

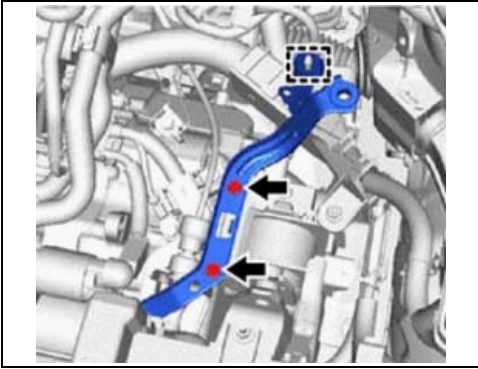

7. INSTALL AIR CLEANER CAP

- a. Install the 2 bolts on lower air CLEANER BRACKET.
Torque: 71 lbf.in {8.0 N·m, 82 kgf·cm}
- b. Engage the wire harness clip onto the bracket.

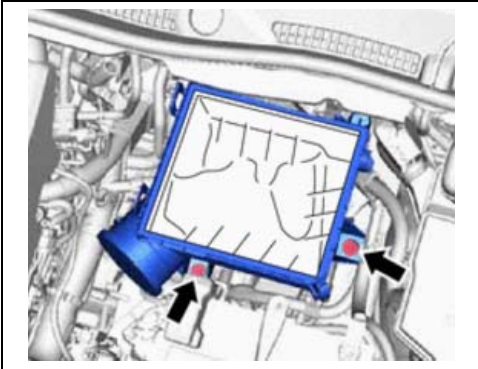

- c. Install the lower air cleaner case.
- d. Install the 2 mounting bolts.
Torque: 44 lbf.in {5.0 N·m, 51 kgf·cm}
- e. Install air cleaner filter element

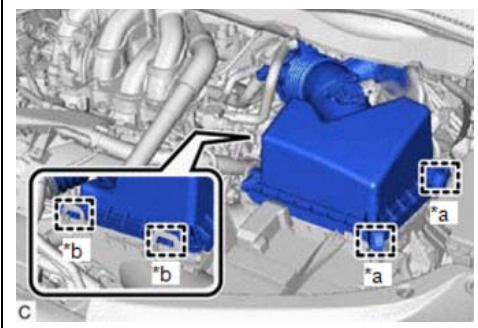

- f. Slide the hose onto the throttle body.
- g. Engage the 2 air cleaner cap guides (*b).
- h. Engage the clamps onto the cap (*a).

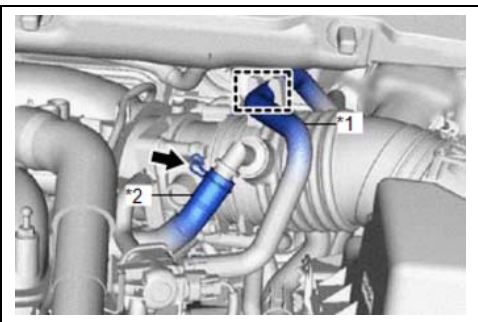

- i. Connect the mass air flow meter electrical connector.
- j. Engage harness clip into the wire harness clamp.
- k. Engage the fuel Vapor hose (*1) into the clamp.
- l. Connect the ventilation hose (*2).
- m. Tighten the hose clamp on the throttle body.

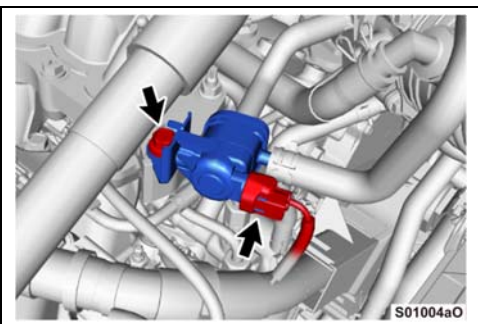

8. INSTALL PURGE VSV

- a. Bolt the Purge VSV to the intake plenum.
Torque: 15 lbf.ft {21 N·m, 214 kgf·cm}
- b. Plug the electrical connector into the VSV.
- c. Install the V-bank cover.

◀ VERIFY REPAIR QUALITY ▶

1. Confirm proper operation of the power assist brakes
2. Confirm there are no oil leaks
3. Confirm there are no warning lights illuminated

If you have any questions regarding this update, please contact your area representative.

10. APPENDIX

A. PARTS DISPOSAL

As required by Federal Regulations, please make sure all recalled parts (original parts) removed from the vehicle are disposed of in a manner in which they will not be reused, **unless requested for parts recovery return.**

B. CAMPAIGN DESIGNATION DECORDER

