

Safety Recall

Code: 69R6



Audi

REVISION

Subject	Driver Frontal Airbag Inflator (Takata)
Release Date	February 18, 2022
Revision Summary	<u>USA ONLY</u> Updated Rental Car/Loaner claiming labor number
Affected Vehicles	<i>U.S.A. & Canada: Certain 2006-2013 MY Audi vehicles equipped with a Takata driver frontal airbag</i> <i>Check Campaigns/Actions screen in Elsa on the day of repair to verify that a VIN qualifies for repair under this action. Elsa is the <u>only</u> valid campaign inquiry & verification source.</i> <ul style="list-style-type: none">✓ Campaign status must show "open."✓ If Elsa shows other open action(s), inform your customer so that the work can also be completed at the same time the vehicle is in the workshop for this campaign.
Problem Description	The driver airbag may explode in a crash with airbag deployment. Sharp metal fragments can hit people and cause serious injury or death. Owners should schedule this recall repair immediately, even if an interim repair was recently done.
Corrective Action	Replace the driver frontal airbag inflator (final remedy repair).
Code Visibility	On or about September 28, 2018, criteria 05 through 20 affected vehicles were listed on the Inventory Vehicle Open Campaign Action report under My Dealership Reports (found on www.accessaudi.com & OMD Web). A list was not posted for dealers who did not have any affected vehicles. On or about September 28, 2018, this campaign code showed open on the affected criteria 05 through 20 vehicles in Elsa.
Owner Notification	Owner notification took place according to the schedule provided by the National Highway Traffic Safety Administration (NHTSA). Owner letter examples are included in this bulletin for your reference.
Additional Information	Please alert everyone in your dealership about this action, including Sales, Service, Parts and Accounting personnel. Contact Warranty if you have any questions. IMPORTANT REMINDER ON VEHICLES AFFECTED BY SAFETY & COMPLIANCE RECALLS <u>New Vehicles in Dealer Inventory:</u> It is a violation of Federal law for a dealer to deliver a new motor vehicle or any new or used item of motor vehicle equipment (including a tire) covered by this notification under a sale or lease until the defect or noncompliance is remedied. By law, dealers must correct, prior to delivery for sale or lease, any vehicle that fails to comply with an applicable Federal Motor Vehicle Safety Standard or that contains a defect relating to motor vehicle safety. <u>Pre-Owned Vehicles in Dealer Inventory:</u> Dealers should not deliver any pre-owned vehicles in their inventory which are involved in a safety or compliance recall until the defect has been remedied. Dealers must ensure that every affected inventory vehicle has this campaign completed <u>before delivery to consumers</u> .
Parts Information	<u>15 Day Supply Parts will be allocated to dealers:</u> <ul style="list-style-type: none">• This 15-day supply calculation will be updated TWICE EACH WEEK on Mondays and Wednesdays.• To ensure a consistent flow of replacement parts to your dealerships, parts will be allocated and delivered to your dealership TWICE EACH WEEK as well.

- Replenishment parts are scheduled to be delivered to your dealership on both Wednesday and Friday each week.
- Please manage your appointments and work flow with this replenishment strategy in mind.

In the unlikely event that you encounter a situation where you have an unexpected customer for a Takata campaign and do not have the proper inflator in stock, please follow the following process:

1. Write a repair order and place the customer in a loaner.
2. Write the required part number on the face of the R.O.
3. Scan and email a copy of the repair order to VWoAPartsSpecialists@vw.com

An order will be placed for that individual customer.

Your supply level will be checked prior to an order being placed. If your inventory appears sufficient, your order will not be placed.

To have a part that is *not* in the 15 day allocation program:

Contact Parts Specialist: via phone (800-767-6552), Chat/ Text via POC or Email at VWoAPartsSpecialists@vw.com with VIN to order.

Model	Criteria	Part Number	Ordering/Supply Method
Q5	01	8R0 898 201 B	15 Day Supply
	02	8R0 898 201 C	15 Day Supply
A5 Cabriolet	03	8F0 898 201 A	15 Day Supply
A3/A4 Cabriolet	05	8P0 898 201 A	Contact Parts Specialist
	06	8P0 880 201 CL 6PS	15 Day Supply
	07	8P0 880 201 CE 6PS	Contact Parts Specialist
	08	8P0 880 201 CG 6PS	Contact Parts Specialist
	09	8H0 880 201 AL 6PS	Contact Parts Specialist
	10	8H0 880 201 AL 1DH	Contact Parts Specialist
	11	8H0 880 201 AL 1GK	Contact Parts Specialist
	12	8H0 880 201 AP 6PS	Contact Parts Specialist
	13	8H0 880 201 AP 1DH	Contact Parts Specialist
	14	8H0 880 201 AP 1GK	Contact Parts Specialist
	15	8H0 880 201 AM 6PS	Contact Parts Specialist
	16	8H0 880 201 AM 1DH	Contact Parts Specialist
	17	8H0 880 201 AM 1GK	Contact Parts Specialist
	18	8H0 880 201 AQ 6PS	Contact Parts Specialist
	19	8H0 880 201 AQ 1DH	Contact Parts Specialist
	20	8H0 880 201 AQ 1GK	Contact Parts Specialist

Claim Entry Instructions

After campaign has been completed, enter claim as soon as possible to help prevent work from being duplicated elsewhere. Attach the Elsa screen print showing action open on the day of repair to the repair order.

If customer refused campaign work:

- ✓ U.S. dealers: Submit the request through Audi Warranty Online under the Campaigns/Update option.
- ✓ Canada dealers: Upload the repair order to Audi WIN/Operations/Campaign Closure.

Service Number	69R6
Damage Code	0099
Parts Vendor Code	002
Claim Type	Sold vehicle: 7 10 Unsold vehicle: 7 90
Causal Indicator	*Mark airbag inflator as causal part
Vehicle Wash/Loaner	USA: Do not claim wash under this action. For rental/loaner claiming, see special coverage claiming section. Canada: Do not claim wash/loaner under this action

Vehicles have more than one criteria. Claim all applicable criteria listed below on one claim.

Criteria I.D.	01 and 8R						
	Install new airbag inflator. Labor operation: 6958 5699 95 T.U. <table border="1"><thead><tr><th>Quantity</th><th>Part Number</th><th>Description</th></tr></thead><tbody><tr><td>1.00</td><td>8R0898201B*</td><td>Airbag Inflator</td></tr></tbody></table>	Quantity	Part Number	Description	1.00	8R0898201B*	Airbag Inflator
Quantity	Part Number	Description					
1.00	8R0898201B*	Airbag Inflator					
Criteria I.D.	02 and 8R						
	Install new airbag inflator. Labor operation: 6958 5699 95 T.U. <table border="1"><thead><tr><th>Quantity</th><th>Part Number</th><th>Description</th></tr></thead><tbody><tr><td>1.00</td><td>8R0898201C*</td><td>Airbag Inflator</td></tr></tbody></table>	Quantity	Part Number	Description	1.00	8R0898201C*	Airbag Inflator
Quantity	Part Number	Description					
1.00	8R0898201C*	Airbag Inflator					
Criteria I.D.	03 and 8F						
	Install new airbag inflator. Labor operation: 6958 5599 85 T.U. <table border="1"><thead><tr><th>Quantity</th><th>Part Number</th><th>Description</th></tr></thead><tbody><tr><td>1.00</td><td>8F0898201A*</td><td>Airbag Inflator</td></tr></tbody></table>	Quantity	Part Number	Description	1.00	8F0898201A*	Airbag Inflator
Quantity	Part Number	Description					
1.00	8F0898201A*	Airbag Inflator					

Continue to next page

Criteria I.D.	11 and 8H						
	<p>Install new airbag assembly.</p> <p>Labor operation: 6958 5799 55 T.U.</p> <table border="1"> <thead> <tr> <th>Quantity</th> <th>Part Number</th> <th>Description</th> </tr> </thead> <tbody> <tr> <td>1.00</td> <td>8H0880201AL1GK*</td> <td>Airbag Assembly</td> </tr> </tbody> </table>	Quantity	Part Number	Description	1.00	8H0880201AL1GK*	Airbag Assembly
Quantity	Part Number	Description					
1.00	8H0880201AL1GK*	Airbag Assembly					
Criteria I.D.	12 and 8H						
	<p>Install new airbag assembly.</p> <p>Labor operation: 6958 5799 55 T.U.</p> <table border="1"> <thead> <tr> <th>Quantity</th> <th>Part Number</th> <th>Description</th> </tr> </thead> <tbody> <tr> <td>1.00</td> <td>8H0880201AP6PS*</td> <td>Airbag Assembly</td> </tr> </tbody> </table>	Quantity	Part Number	Description	1.00	8H0880201AP6PS*	Airbag Assembly
Quantity	Part Number	Description					
1.00	8H0880201AP6PS*	Airbag Assembly					
Criteria I.D.	13 and 8H						
	<p>Install new airbag assembly.</p> <p>Labor operation: 6958 5799 55 T.U.</p> <table border="1"> <thead> <tr> <th>Quantity</th> <th>Part Number</th> <th>Description</th> </tr> </thead> <tbody> <tr> <td>1.00</td> <td>8H0880201AP1DH*</td> <td>Airbag Assembly</td> </tr> </tbody> </table>	Quantity	Part Number	Description	1.00	8H0880201AP1DH*	Airbag Assembly
Quantity	Part Number	Description					
1.00	8H0880201AP1DH*	Airbag Assembly					
Criteria I.D.	14 and 8H						
	<p>Install new airbag assembly.</p> <p>Labor operation: 6958 5799 55 T.U.</p> <table border="1"> <thead> <tr> <th>Quantity</th> <th>Part Number</th> <th>Description</th> </tr> </thead> <tbody> <tr> <td>1.00</td> <td>8H0880201AP1GK*</td> <td>Airbag Assembly</td> </tr> </tbody> </table>	Quantity	Part Number	Description	1.00	8H0880201AP1GK*	Airbag Assembly
Quantity	Part Number	Description					
1.00	8H0880201AP1GK*	Airbag Assembly					
Criteria I.D.	15 and 8H						
	<p>Install new airbag assembly.</p> <p>Labor operation: 6958 5799 55 T.U.</p> <table border="1"> <thead> <tr> <th>Quantity</th> <th>Part Number</th> <th>Description</th> </tr> </thead> <tbody> <tr> <td>1.00</td> <td>8H0880201AM6PS*</td> <td>Airbag Assembly</td> </tr> </tbody> </table>	Quantity	Part Number	Description	1.00	8H0880201AM6PS*	Airbag Assembly
Quantity	Part Number	Description					
1.00	8H0880201AM6PS*	Airbag Assembly					
Criteria I.D.	16 and 8H						
	<p>Install new airbag assembly.</p> <p>Labor operation: 6958 5799 55 T.U.</p> <table border="1"> <thead> <tr> <th>Quantity</th> <th>Part Number</th> <th>Description</th> </tr> </thead> <tbody> <tr> <td>1.00</td> <td>8H0880201AM1DH*</td> <td>Airbag Assembly</td> </tr> </tbody> </table>	Quantity	Part Number	Description	1.00	8H0880201AM1DH*	Airbag Assembly
Quantity	Part Number	Description					
1.00	8H0880201AM1DH*	Airbag Assembly					

Continue to next page

Criteria I.D.	17 and 8H						
	<p>Install new airbag assembly.</p> <p>Labor operation: 6958 5799 55 T.U.</p> <table border="1"> <thead> <tr> <th>Quantity</th> <th>Part Number</th> <th>Description</th> </tr> </thead> <tbody> <tr> <td>1.00</td> <td>8H0880201AM1GK*</td> <td>Airbag Assembly</td> </tr> </tbody> </table>	Quantity	Part Number	Description	1.00	8H0880201AM1GK*	Airbag Assembly
Quantity	Part Number	Description					
1.00	8H0880201AM1GK*	Airbag Assembly					
Criteria I.D.	18 and 8H						
	<p>Install new airbag assembly.</p> <p>Labor operation: 6958 5799 55 T.U.</p> <table border="1"> <thead> <tr> <th>Quantity</th> <th>Part Number</th> <th>Description</th> </tr> </thead> <tbody> <tr> <td>1.00</td> <td>8H0880201AQ6PS*</td> <td>Airbag Assembly</td> </tr> </tbody> </table>	Quantity	Part Number	Description	1.00	8H0880201AQ6PS*	Airbag Assembly
Quantity	Part Number	Description					
1.00	8H0880201AQ6PS*	Airbag Assembly					
Criteria I.D.	19 and 8H						
	<p>Install new airbag assembly.</p> <p>Labor operation: 6958 5799 55 T.U.</p> <table border="1"> <thead> <tr> <th>Quantity</th> <th>Part Number</th> <th>Description</th> </tr> </thead> <tbody> <tr> <td>1.00</td> <td>8H0880201AQ1DH*</td> <td>Airbag Assembly</td> </tr> </tbody> </table>	Quantity	Part Number	Description	1.00	8H0880201AQ1DH*	Airbag Assembly
Quantity	Part Number	Description					
1.00	8H0880201AQ1DH*	Airbag Assembly					
Criteria I.D.	20 and 8H						
	<p>Install new airbag assembly.</p> <p>Labor operation: 6958 5799 55 T.U.</p> <table border="1"> <thead> <tr> <th>Quantity</th> <th>Part Number</th> <th>Description</th> </tr> </thead> <tbody> <tr> <td>1.00</td> <td>8H0880201AQ1GK*</td> <td>Airbag Assembly</td> </tr> </tbody> </table>	Quantity	Part Number	Description	1.00	8H0880201AQ1GK*	Airbag Assembly
Quantity	Part Number	Description					
1.00	8H0880201AQ1GK*	Airbag Assembly					

USA ONLY – Special Coverage Claiming

Rental Car/Loaner Claiming							
Criteria I.D.	All criteria						
	OUTSIDE LABOR						
	<table border="1"> <thead> <tr> <th>Labor Number</th> <th>Description</th> <th>Amount</th> </tr> </thead> <tbody> <tr> <td>LOAN69R6</td> <td>RENTAL/LOANER</td> <td>Enter dollar amount on rental/loaner invoice</td> </tr> </tbody> </table>	Labor Number	Description	Amount	LOAN69R6	RENTAL/LOANER	Enter dollar amount on rental/loaner invoice
Labor Number	Description	Amount					
LOAN69R6	RENTAL/LOANER	Enter dollar amount on rental/loaner invoice					

Customer Letter Example (USA)

This notice applies to your vehicle: <VIN>

NHTSA: <INSERT NUMBER>

**Subject: Safety Recall 69R6 – Driver Frontal Airbag Inflator (Takata)
Certain 2006-2013 MY Audi Vehicles**

Dear Audi Owner,

This notice is sent to you in accordance with the National Traffic and Motor Vehicle Safety Act. Audi has decided that a defect, which relates to motor vehicle safety, exists in certain 2006-2013 model year Audi vehicles. Our records show that you are the owner of a vehicle affected by this action.

DANGER!

**The driver airbag may explode in a crash with airbag deployment.
Sharp metal fragments can hit people and cause serious injury or death.**

What should you do?	Schedule this recall repair immediately, even if an interim repair was recently done. Please contact your authorized Audi dealer without delay to schedule this recall repair. For your convenience, you can also visit www.audiusa.com and click on the "Find a Dealer" link to locate a dealer near you and schedule this service.
What will we do?	To correct this defect, your authorized Audi dealer will replace the driver airbag inflator in your vehicle. This work will take about two hours to complete and will be performed for you free of charge. Please keep in mind that your dealer may need additional time for the preparation of the repair, as well as to accommodate their daily workshop schedule.
Lease vehicles and address changes	If you are the lessor and registered owner of the vehicle identified in this action, the law requires you to forward this letter immediately via first-class mail to the lessee within ten (10) days of receipt. If you have changed your address or sold the vehicle, please fill out the enclosed prepaid Owner Reply card and mail it to us so we can update our records.
Can we assist you further?	If you need help scheduling this repair, or if your authorized Audi dealer fails or is unable to complete this work free of charge within a reasonable time, please contact Audi Customer Experience at 1-800-253-2834 or via our "Contact Us" page at www.audiusa.com .
Checking your vehicle for open Recalls and Service Campaigns	To check your vehicle's eligibility for repair under this or any other recall/service campaign, please visit the Recall/Service Campaign Lookup tool at www.audiusa.com and enter your Vehicle Identification Number (VIN).

If you still cannot obtain satisfaction, you may file a complaint with: The Administrator, National Highway Traffic Safety Administration, 1200 New Jersey Avenue, SE., Washington, DC 20590; or call the toll-free Vehicle Safety Hotline at 1-888-327-4236 (TTY: 1-800-424-9153); or go to <http://www.safercar.gov>.

We apologize for any inconvenience this matter may cause; however we are taking this action to help ensure your safety and continued satisfaction with your vehicle.

Sincerely,

Audi Customer Protection

Customer Letter Example (CANADA)

This notice applies to your vehicle: <VIN>

**Subject: Safety Recall 69R6 – Driver Frontal Airbag Inflator (Takata)
Certain 2006-2013 MY Audi Vehicles**

Dear Audi Owner,

This notice is sent to you in accordance with the requirements of the Motor Vehicle Safety Act. Audi has decided that a defect, which relates to motor vehicle safety, exists in certain 2006-2013 model year Audi vehicles. Our records show that you are the owner of a vehicle affected by this action.

DANGER!

The driver airbag may explode in a crash with airbag deployment.

Sharp metal fragments can hit people and cause serious injury or death.

What should you do? **Schedule this recall repair immediately, even if an interim repair was recently done.**

Please contact your authorized Audi dealer without delay to schedule this recall repair.

What will we do? To correct this defect, your authorized Audi dealer will replace the driver airbag inflator in your vehicle. This work will take about two hours to complete and will be performed for you free of charge.

Please keep in mind that your dealer may need additional time for the preparation of the repair, as well as to accommodate their daily workshop schedule.

Lease vehicles and address changes If you are the lessor and registered owner of the vehicle identified in this action, the law requires you to forward this letter immediately via first-class mail to the lessee within ten (10) days of receipt. If you have changed your address or sold the vehicle, please fill out the enclosed prepaid Owner Reply card and mail it to us so we can update our records.

Can we assist you further? If your authorized Audi dealer fails or is unable to complete this work free of charge within a reasonable time, please contact Audi Customer Relations Monday through Friday from 8AM to 8PM EST at 1-800-822-2834 or via our "Contact Audi Canada" page at www.audi.ca.

We apologize for any inconvenience this matter may cause; however we are taking this action to help ensure your safety and continued satisfaction with your vehicle.

Sincerely,

Audi Customer Protection

DANGER

- The driver frontal airbag inflator could potentially rupture (due to propellant degradation occurring after long-term exposure to absolute high humidity and temperature cycling). In the event of an inflator rupture, in very rare cases metal fragments could pass through the airbag cushion material, which may result in serious injury or death.
- All Takata Recalls should be performed before any other work is performed on the vehicle.

WARNING

Risk of injury. Refer to “Warning and Safety Precautions”, found in **Appendix A** at the end of this document.

NOTE

- Damages resulting from improper repair or failure to follow these work instructions are the dealer's responsibility and are not eligible for reimbursement under this action.
- This procedure must be read in its entirety prior to performing the repair.
- Due to variations in vehicle equipment and options, the steps/illustrations in this work procedure may not identically match all affected vehicles.
- Diagnosis and repair of pre-existing conditions in the vehicle are not covered under this action.

Required Parts

<u>Criteria</u>	<u>Quantity</u>	<u>Model (model code)</u>	<u>Part Number</u>	<u>Part Description</u>
01	1	Q5 (8R)	8R0 898 201 B	Airbag Inflator Kit Without Vibration Damper
02	1		8R0 898 201 C	Airbag Inflator Kit With Vibration Damper
03	1	A5 Cabriolet (8F)	8F0 898 201 A	Airbag Inflator Kit With Vibration Damper
05	1	A3/A4 Cabriolet (8H or 8P)	8P0 898 201 A	Airbag Inflator Kit With Vibration Damper
06	1		8P0 880 201 CL 6PS	Airbag Assembly
07	1		8P0 880 201 CE 6PS	Airbag Assembly
08	1		8P0 880 201 CG 6PS	Airbag Assembly
09	1		8H0 880 201 AL 6PS	Airbag Assembly
10	1		8H0 880 201 AL 1DH	Airbag Assembly
11	1		8H0 880 201 AL 1GK	Airbag Assembly
12	1		8H0 880 201 AP 6PS	Airbag Assembly
13	1		8H0 880 201 AP 1DH	Airbag Assembly
14	1		8H0 880 201 AP 1GK	Airbag Assembly
15	1		8H0 880 201 AM 6PS	Airbag Assembly
16	1		8H0 880 201 AM 1DH	Airbag Assembly
17	1		8H0 880 201 AM 1GK	Airbag Assembly
18	1		8H0 880 201 AQ 6PS	Airbag Assembly
19	1		8H0 880 201 AQ 1DH	Airbag Assembly
20	1		8H0 880 201 AQ 1GK	Airbag Assembly

NOTE

All inflator kits include inflator, inflator nuts, horn ring bolts, and return instructions.

Required Safety Equipment



- Ear Protection (locally sourced).



- Face Shield (locally sourced).

Required Tools



- ESD Worksurface - VAS 6613



- Bar Code Scanner – VAS6161/1



- Airbag Support - T10568



- VAS6150D - Diagnostic Tester (or equivalent)



- VAG1410 – Torque Wrench (or equivalent)

Required Work Environment

⚠ WARNING

Risk of injury.

It is critical that a clean, uncongested work environment is utilized during the inflator replacement procedure. Extra tools, debris, etc... in the blast area of an airbag impose a danger in the event an airbag were to deploy. Ensure there are no loose components in the blast area of the airbag.

! NOTE

The work area must be in the vicinity of the scan tool and the vehicle in order to properly complete this procedure.



- Workbench that will support a vice.
- Work surface free of unnecessary tools, equipment and debris.

Repair Instruction

Section A - Check for Previous Repair

Applicable criteria ID(s)	Campaign/Action Status
01 ← 2	Open ← 1

EXAMPLE

- Enter the VIN in Elsa and proceed to the “Campaign/Action” screen.

TIP

On the date of repair, print this screen and keep a copy with the repair order.

- Confirm the Campaign/Action is open <arrow 1>. If the status is closed, no further work is required.
- Note the Applicable Criteria ID <arrow 2> for use in determining the correct work to be done and corresponding parts associated.

Proceed to Section B

Section B – Inflator Identification (all vehicles)

WARNING

Risk of injury.

- People in the immediate vicinity of the workplace must be protected from possible noise and projectiles.
- Pyrotechnic components can trigger unintentionally.
- In the event of unintentional deployment:
 - Single-stage generators: allow airbag to cool down completely. Wait at least 10 minutes before handling.
 - Two-stage generators: wait for second airbag ignition. Allow airbag to cool down completely. Wait at least 10 minutes before handling.



- Prior to beginning repairs, verify the horn is operational.

NOTE

Diagnosis and repair of an inoperable horn, before or after inflator replacement, will not be covered under this campaign.



- Use the QR code or the link to view a video detailing the repair process prior to performing the repair.

<https://audi-academy.kzoplatform.com/player/medium/811705205740540937>

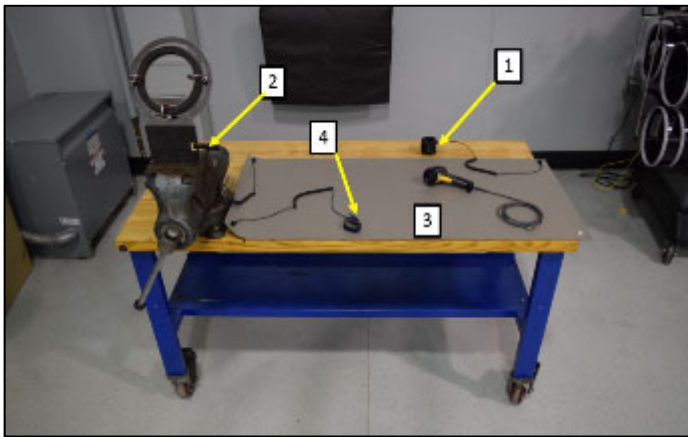

NOTE

- Prior to beginning work, all parts and tools are to be placed on the ESD table mat.
- The workstation must be in the vicinity of the vehicle.

- Assemble ESD workplace -VAS 6613- <1, 2, 3, and 4>.
- Plug ESD workplace into a wall socket using plug <1>.

NOTE

The wall socket or extension cord must have a sufficient ground.

- Clamp Airbag Support T10568 <2> into the vice.
- Connect crocodile clip <1> to airbag support <2> and ESD workplace -VAS 6613-.

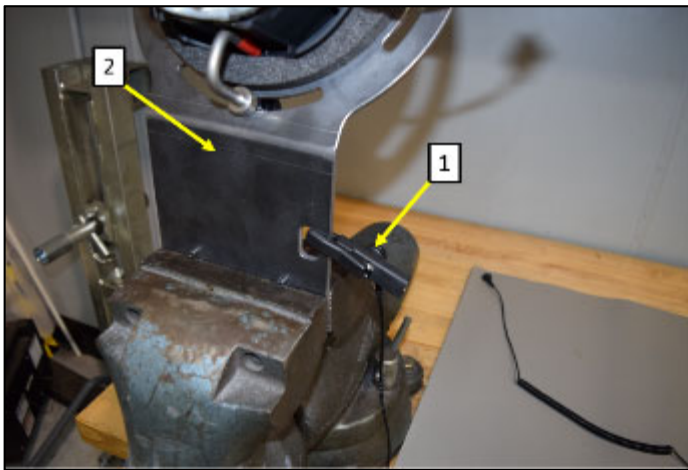

- Ensure ODIS is updated to the latest version.
- Connect vehicle diagnostic tester to the vehicle.
- Select Start Diagnosis function and identify vehicle.
- After identification of control units, Guided Fault Finding is started automatically.
- Follow the instructions on screen.

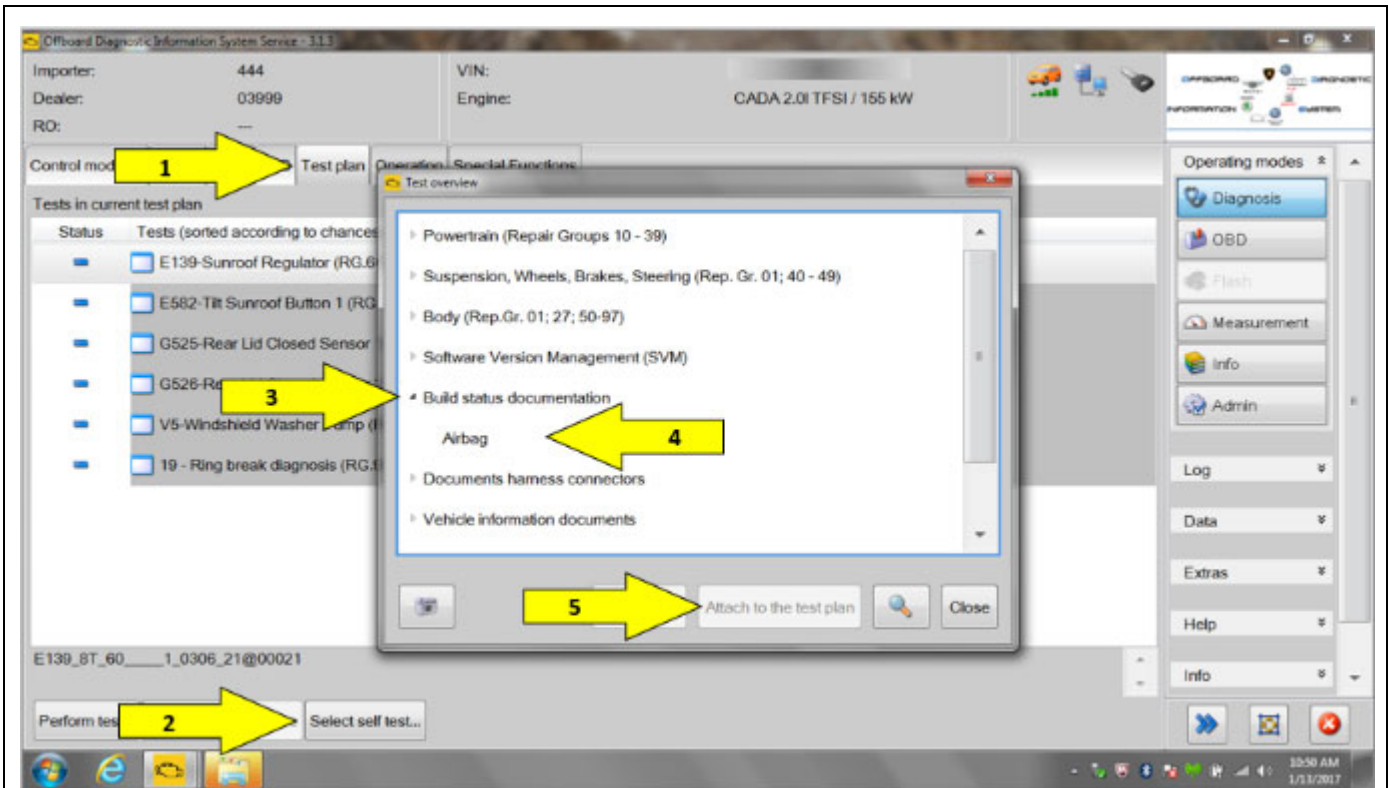

- Select the “Test plan” tab <1>.
- Select “Select self test...” <2>.
- Open the “Build status documentation” dropdown <3>.
- Highlight “Airbag” <4>.
- Select “Attach to the test plan <5>.

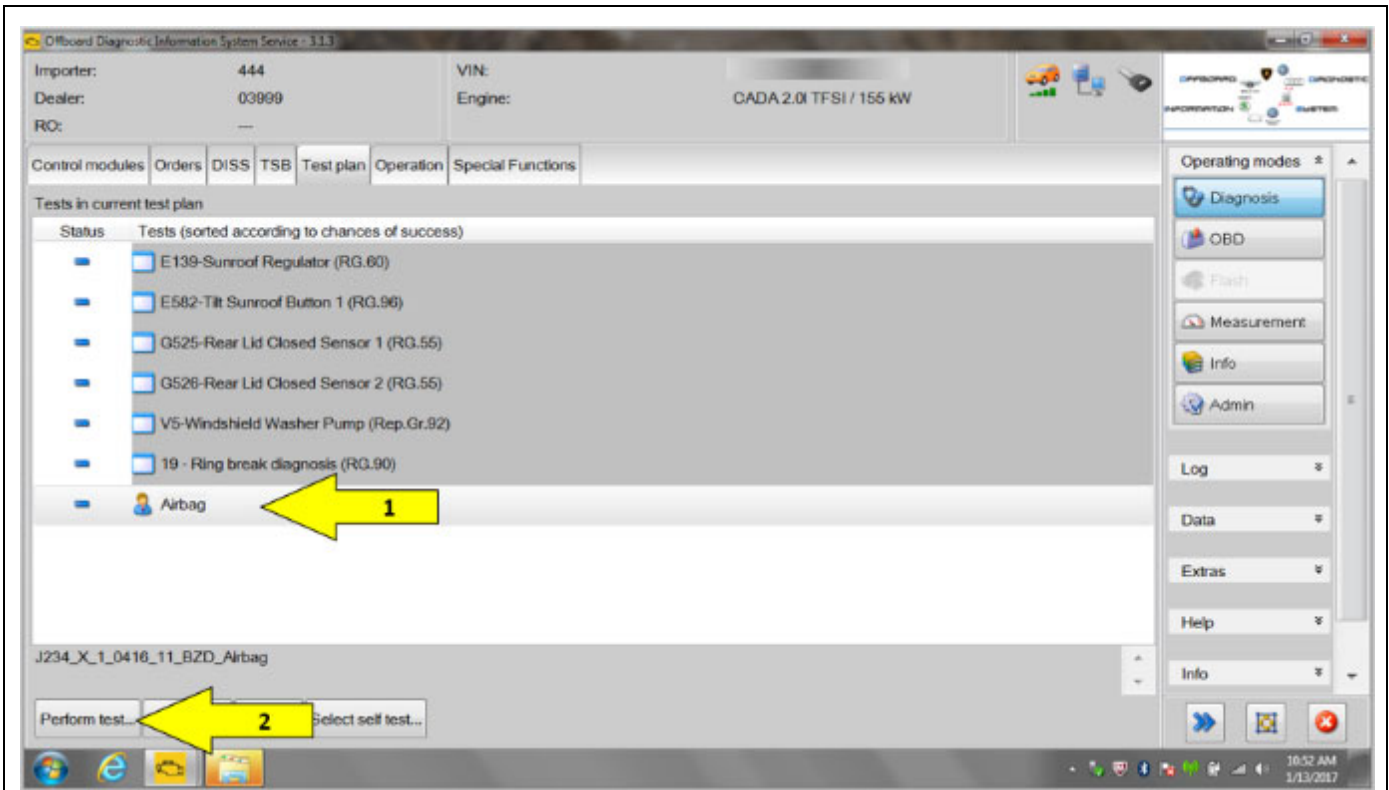

- Highlight the “Airbag” test plan <1>.
- Select “Perform test...” <2>.

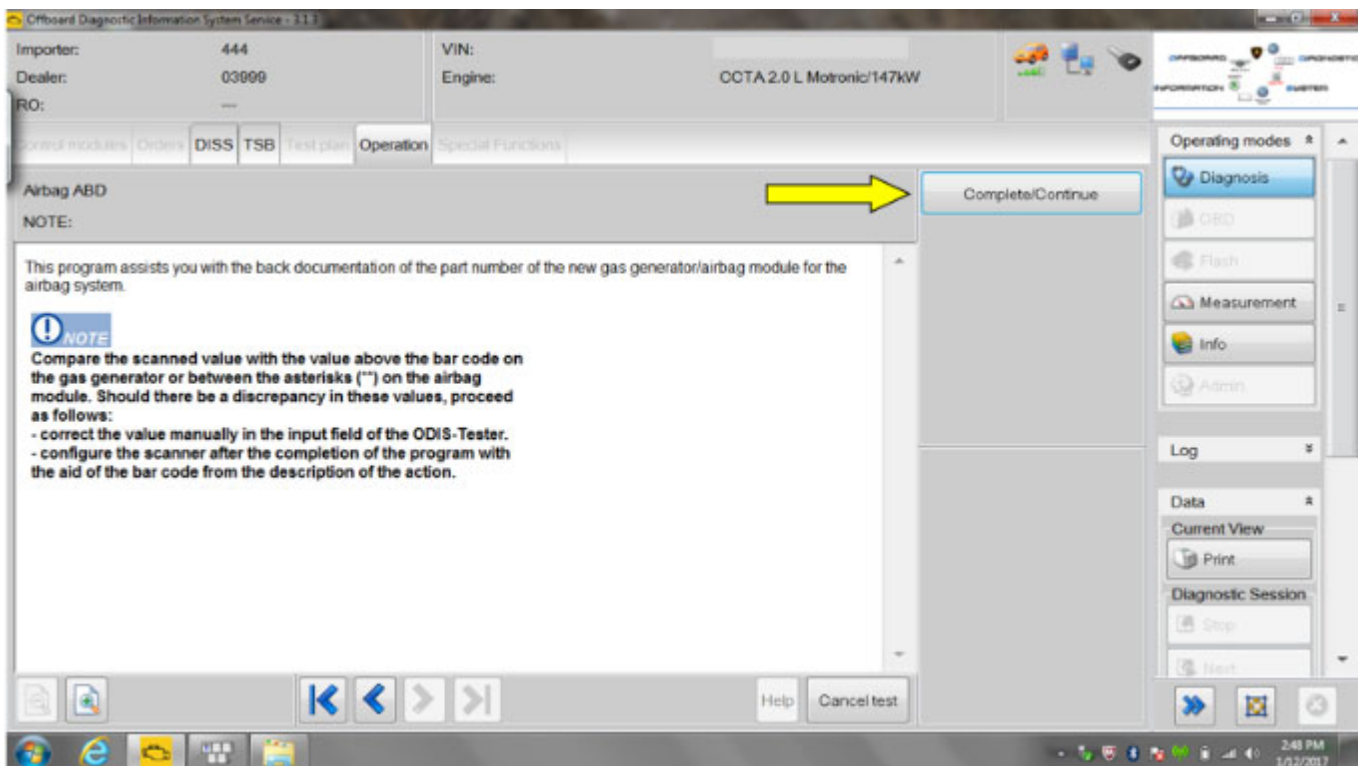

- Scanning the data matrix code during this test plan step calibrates the scanner to avoid error messages.
- Scanning the calibrating data matrix code may not have to be done every time. Only when the scanner requires calibration. You will know if the scanner needs calibrating if the scanner does not scan the inflator's data matrix code.
- If the inflator data matrix code cannot be scanned, then print out the data matrix code shown below and scan the printout.



- After calibrating the scanner, select **“Complete/Continue”**

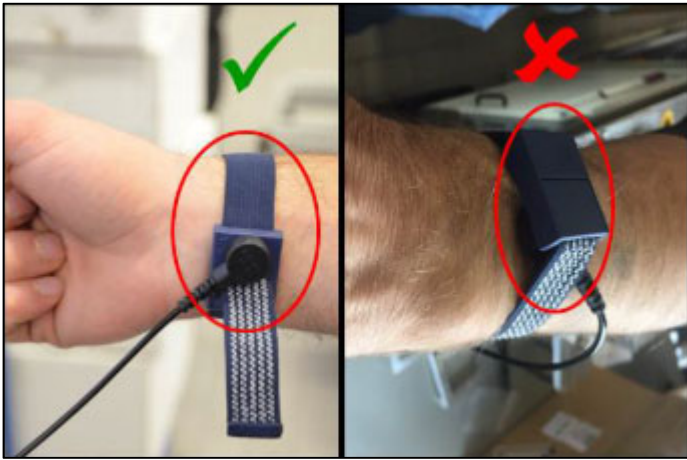

- Put the wrist strap from the ESD workplace on your wrist.

⚠ CAUTION

The white dots on the wrist strap must be against the skin.

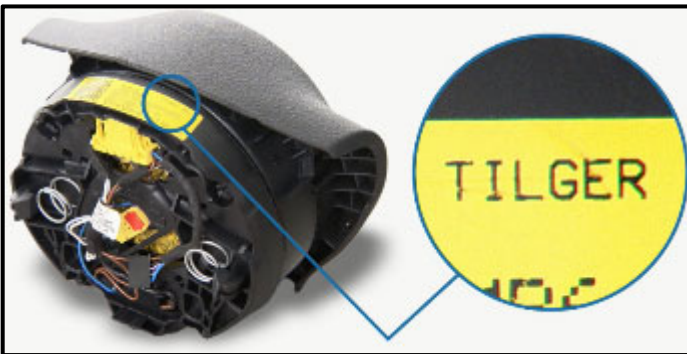

! NOTE

- There are two types of inflator. One version is “with vibration absorption” and one is “without vibration absorption”.
- Airbags with vibration absorption may be identified by the word “TILGER” on the label found on the airbag.

! NOTE

In the event an airbag had previously been replaced, the replacement airbag may have an inflator WITH the vibration absorber. If this situation is encountered, the inflator WITH vibration absorption **MUST** be installed:

- Repackage the previously scanned inflator and return to the parts department.
- Acquire the correct inflator from the parts department.
- Scan the new inflator using the GFF test plan.
- Install the new inflator, following the **“Inflator versions WITH vibration absorption”** instructions.



Vehicles with Criteria 01 through 05:

- Place the new inflator on the ESD mat.
- Scan the data matrix code of the new inflator at a distance of about 15 cm.

⚠ CAUTION

Ensure the correct inflator is scanned and installed into the vehicle.

<u>Crit.</u>	<u>Model (model code)</u>	<u>Part Number</u>
01	Q5 (8R)	8R0898201B
02		8R0898201C
03	A5 Cabriolet (8F)	8F0898201A
05	A3 (8P)	8P0898201A

ⓘ NOTE

The photo is for reference only. The inflator that is installed may be either a single stage or dual stage inflator.



Vehicles with Criteria 06 through 20:

- Place the new airbag on the ESD mat.
- Scan the data matrix code <circle> of the new airbag at a distance of about 15 cm.



NOTE

Scanning the bar code on the new airbag will result in an “implausible barcode” message.

Continued for all vehicles:

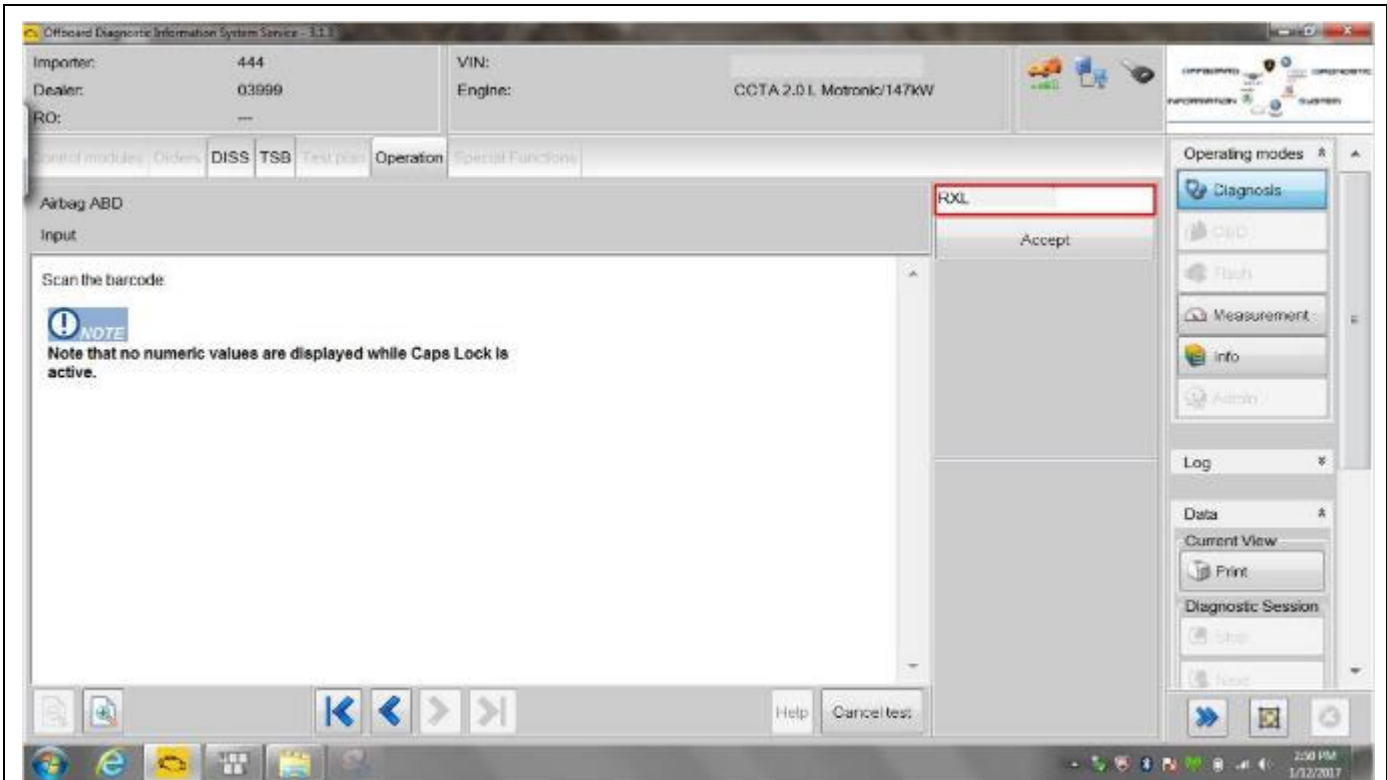

- Once the new inflator has been successfully scanned, press **“Accept”**

NOTE

- Compare the scanned value with the value shown above the data matrix code on the new inflator.
- If there is a discrepancy, manually enter the value from the new inflator in the input field.
- If no value appears, recalibrate the scanner.

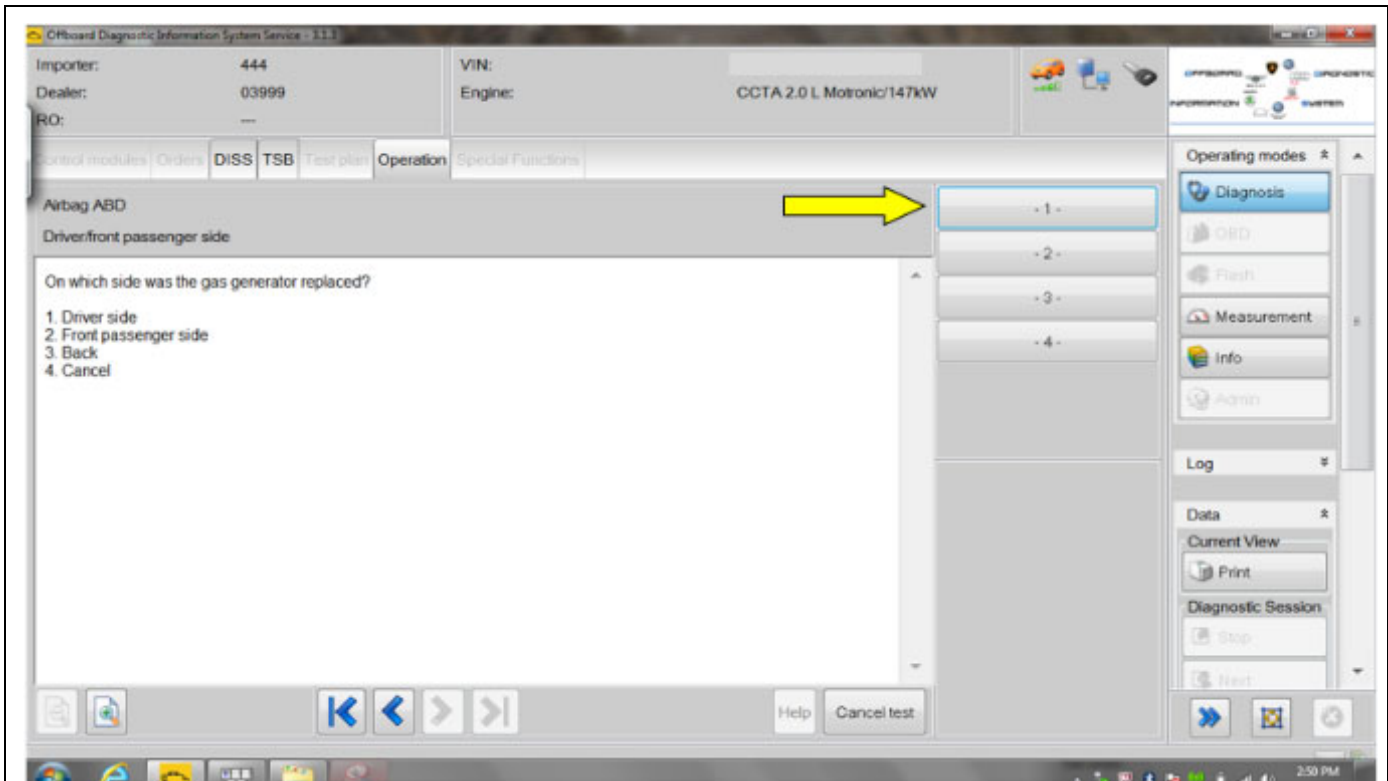

- Select option 1 indicating that the Driver side inflator was replaced.
- After selecting option 1, a valid GeKo ID will need to be entered in order to upload the new inflator identification.

! NOTE (Vehicles with Criteria 06 through 20)

This step will not be populated for vehicles requiring an airbag assembly.

Continue to Section C.

Section C – Battery Disconnect

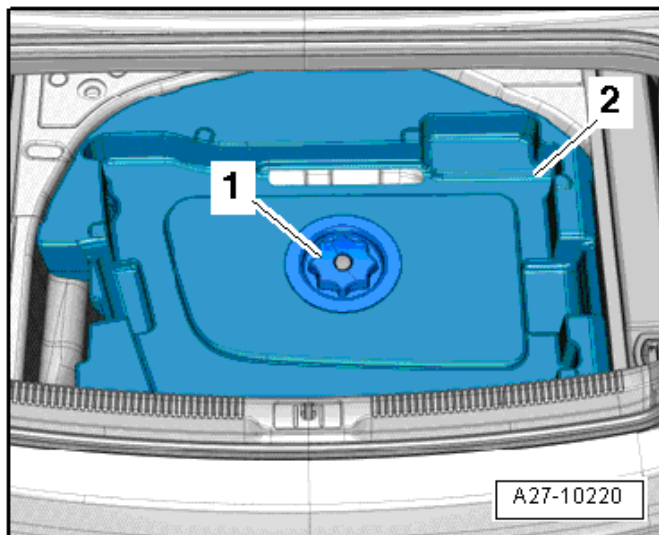

A5 Cabrio Procedure

⚠ WARNING

Accident risk. When working on pyrotechnic components (such as airbags and belt tensioners), the battery must be disconnected with the ignition switched **ON**.

! NOTE

Before disconnecting the battery, it is recommended to record the customer's radio presets so they can be restored before returning vehicle to the customer.

- Turn **ON** the ignition.
- Move the driver seat to the most rearward position.
- Fully recline driver seat.

⚠ CAUTION

Reclining the driver seat before disconnecting the battery allows for additional safety in the event Terminal 15 power is not restored when reconnecting the battery at the end of the repair.

- Lift the luggage compartment floor and engage it on the body.
- Remove the wind deflector from its mount.
- Remove the nut <1> and remove the wind deflector mount <2>.

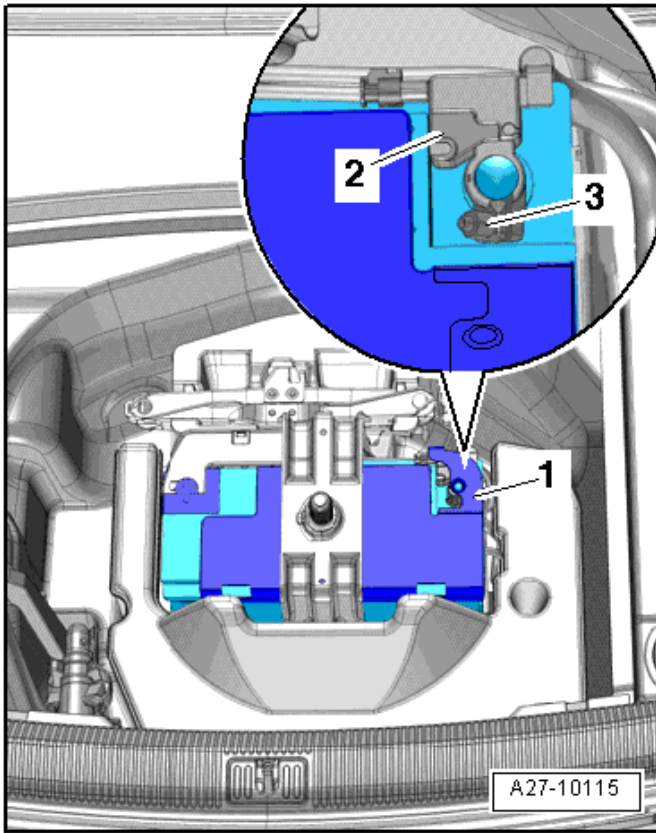

- Open the cover <1> over the battery negative terminal.
- Make sure the ignition is turned **ON**.
- Loosen the nut <3>.
- Remove and isolate the battery ground cable terminal <2> from the battery terminal.

Continue to Section D.

Q5 Procedure

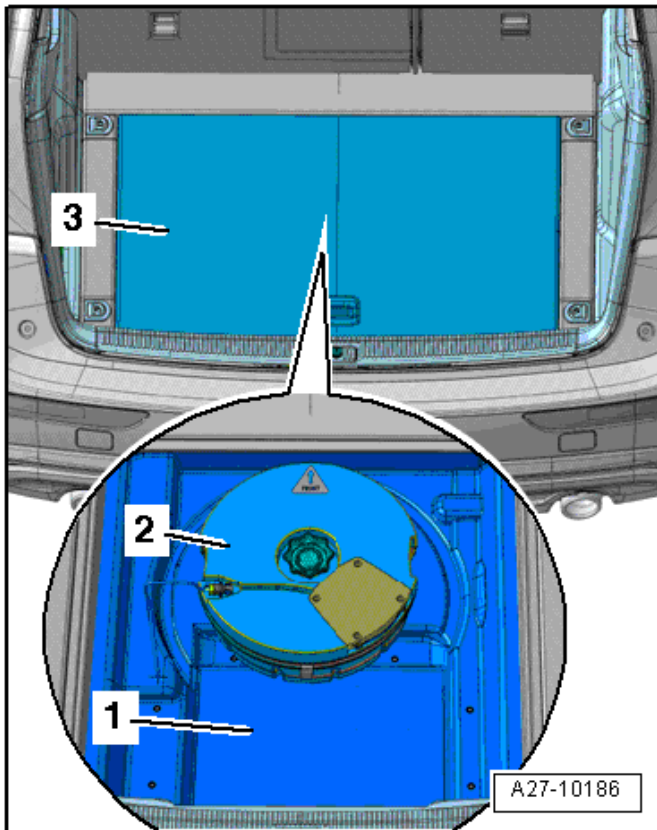

⚠ WARNING

Accident risk. When working on pyrotechnic components (such as airbags and belt tensioners), the battery must be disconnected with the ignition switched **ON**.

! NOTE

Before disconnecting the battery, it is recommended to record the customer's radio presets so they can be restored before returning vehicle to the customer.

- Turn **ON** the ignition.
- Move the driver seat to the most rearward position.
- Fully recline the driver seat.

⚠ CAUTION

Reclining the driver seat before disconnecting the battery allows for additional safety in the event Terminal 15 power is not restored when reconnecting the battery at the end of the repair.

- Remove the luggage compartment floor covering <3>.
- Remove the dirt tray, if applicable.
- If equipped, remove the subwoofer <2>.
- Fold back the carpet <1> over the cover.

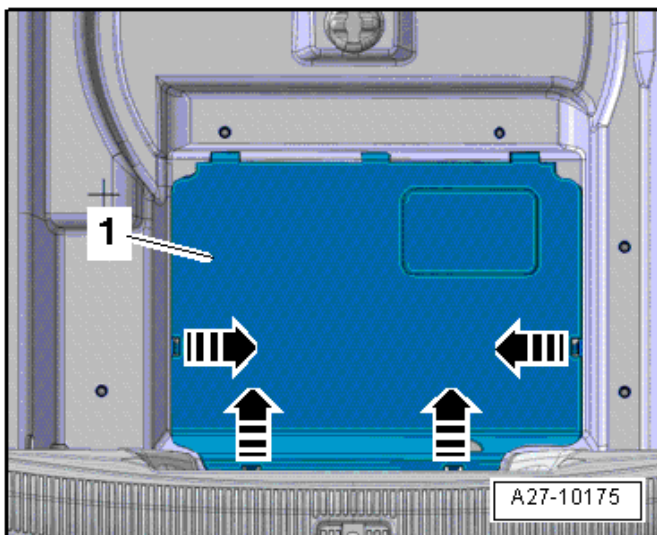

! NOTE

The cover is available with varying numbers of retaining clips.

- Unlock the retaining tabs <arrows> and open the cover <1>.

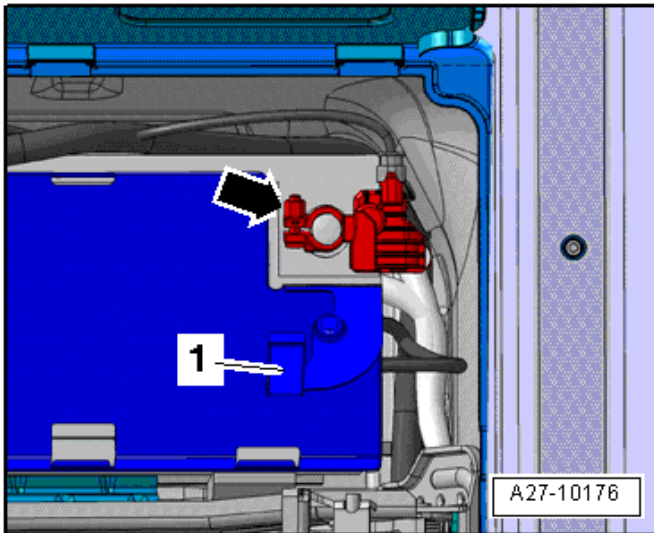

- Open the cover <1> over the battery negative terminal.
- Make sure the ignition is turned **ON**.
- Loosen the nut <arrow>.
- Remove and isolate the battery ground cable terminal from the battery pole.

Continue to Section D.

Section D – Airbag Removal

Bolted Airbag Version

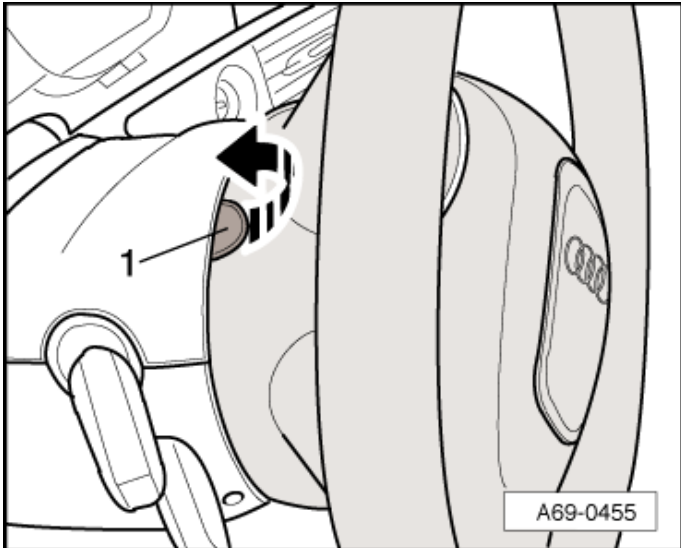

- Adjust the steering column as far down as possible.
- Turn the steering wheel so the cap <1> on the rear side of it faces upward. This is approximately the 12:00 position.
- Pry the cap off <arrow>.

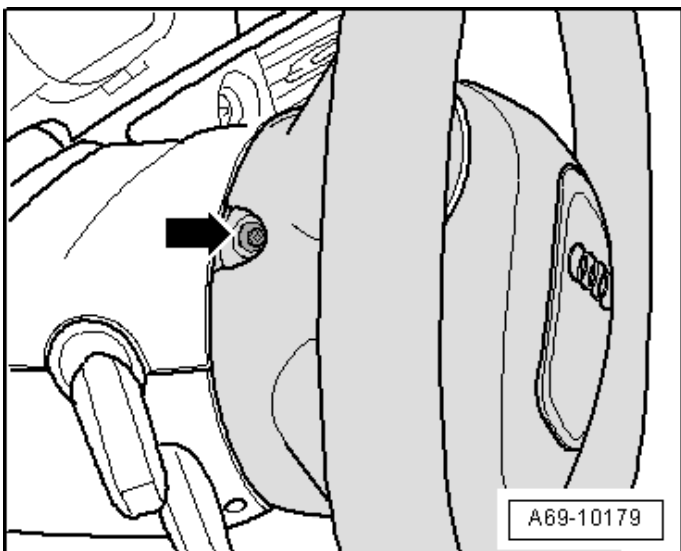

- Remove the driver airbag bolt <arrow>.
- Turn the steering wheel 180° and repeat the procedure on the opposite side.

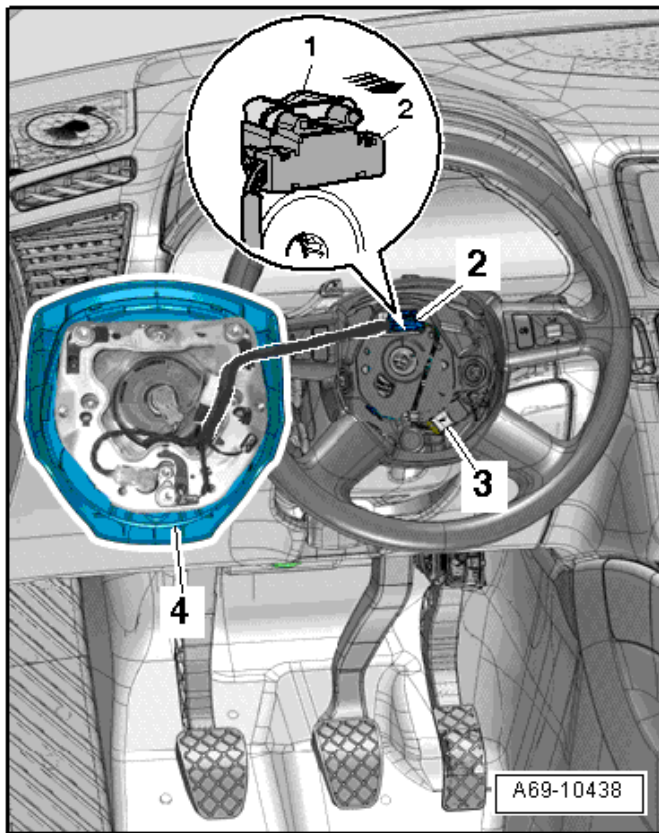

⚠ WARNING

Before handling pyrotechnic components (for example, disconnecting the connector), the person handling it must “discharge static electricity”. This can be done by touching the door striker, for example.

- Bring the steering wheel back into the center (wheels are straight).
- Remove the driver airbag from the steering wheel slightly.
- Pull connector lock <1> as far as stop <arrow>. This releases the electrical connector <2> and it can be removed.
- Versions with Multi-function and Tiptronic steering wheel: Disconnect the connector <3>.
- Remove the airbag <4>.

⚠ WARNING

Set the airbag down so the logo on the impact cushion faces upward.

Attached Airbag Version

- Adjust the steering column as far down as possible.
- Turn the steering wheel so the opening on the rear side of it faces upward. This is approximately the 12:00 position.
- Release the locking bracket <1> in the direction of the arrow using a T25 TORX screwdriver, approximately 100 mm long.

ⓘ NOTE

Electrical wires can be damaged with a flat-head screwdriver. Damage to the wiring is not covered under this action.

- Turn the steering wheel 180° and repeat the procedure on the opposite side.

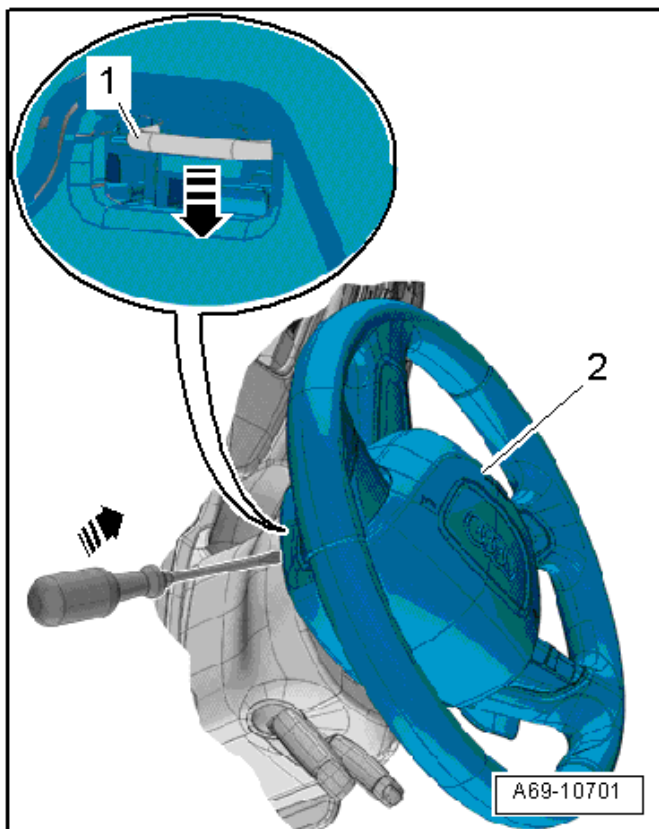

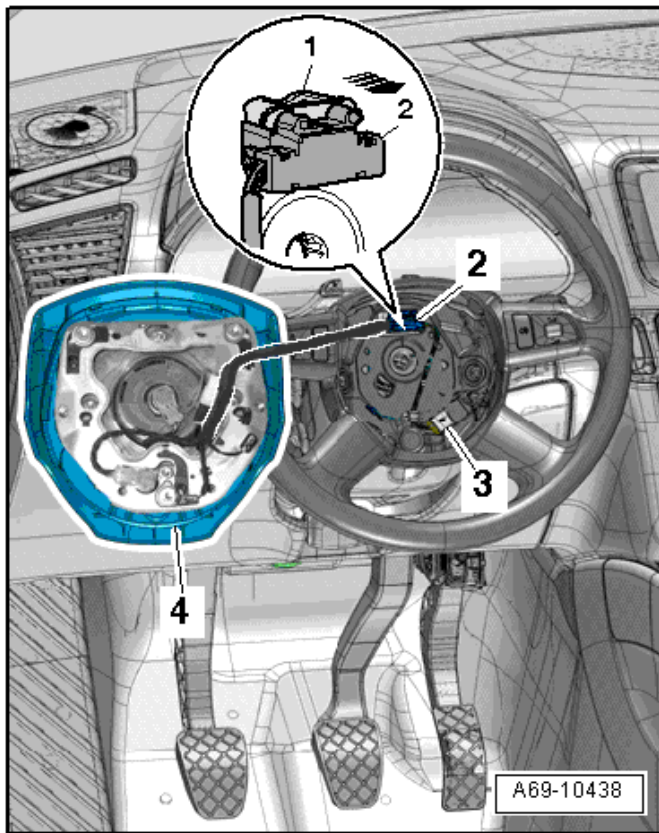

⚠ WARNING

Before handling pyrotechnic components (for example, disconnecting the connector), the person handling it must “discharge static electricity”. This can be done by touching the door striker, for example.

- Bring the steering wheel back into the center (wheels are straight).
- Remove the driver airbag from the steering wheel slightly.
- Pull connector lock <1> as far as stop <arrow>. This releases the electrical connector <2> and it can be removed.
- Versions with Multi-function and Tiptronic steering wheel: Disconnect the connector <3>.
- Remove the airbag <4>.

⚠ WARNING

Set the airbag down so the logo on the impact cushion faces upward.

Once the airbag is removed:

**Vehicles with Criteria 01 through 05:
Continue to Section E.**

**Vehicles with Criteria 06 through 20:
Continue to Section F.**

Section E – Inflator Replacement

⚠ WARNING

Risk of injury.

- People in the immediate vicinity of the workplace must be protected from possible noise and projectiles.
- Pyrotechnic components can trigger unintentionally.
- In the event of unintentional deployment:
 - Single-stage generators: allow airbag to cool down completely. Wait at least 10 minutes before handling.
 - Two-stage generators: wait for second airbag ignition. Allow airbag to cool down completely. Wait at least 10 minutes before handling.

⚠ WARNING

Risk of injury.

It is critical that a clean, uncongested work environment is utilized during the inflator replacement procedure. Extra tools, debris, etc... in the blast area of an airbag impose a danger in the event an airbag were to deploy. Ensure there are no loose components in the blast area of the airbag.



! NOTE

- Prior to beginning work, all parts and tools are to be placed on the ESD table mat.
- The workstation must be in the vicinity of the vehicle.

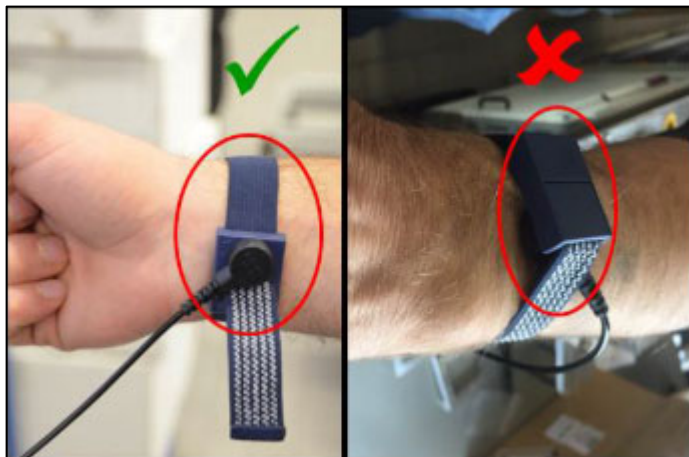

- Put the wrist strap from the ESD workplace on your wrist.

⚠ CAUTION

The white dots on the wrist strap must be against the skin.

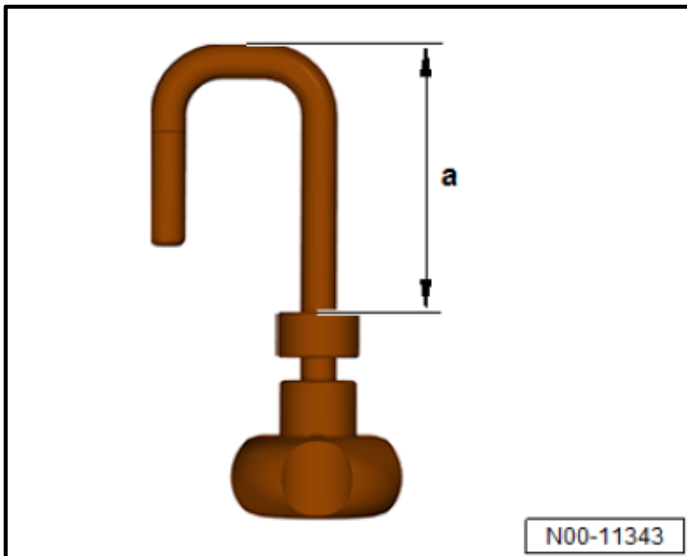

! NOTE

Tighten mounting by hand to prevent damage.

- Adjust three knurled nuts of securing hooks to <dimension a> 50mm.

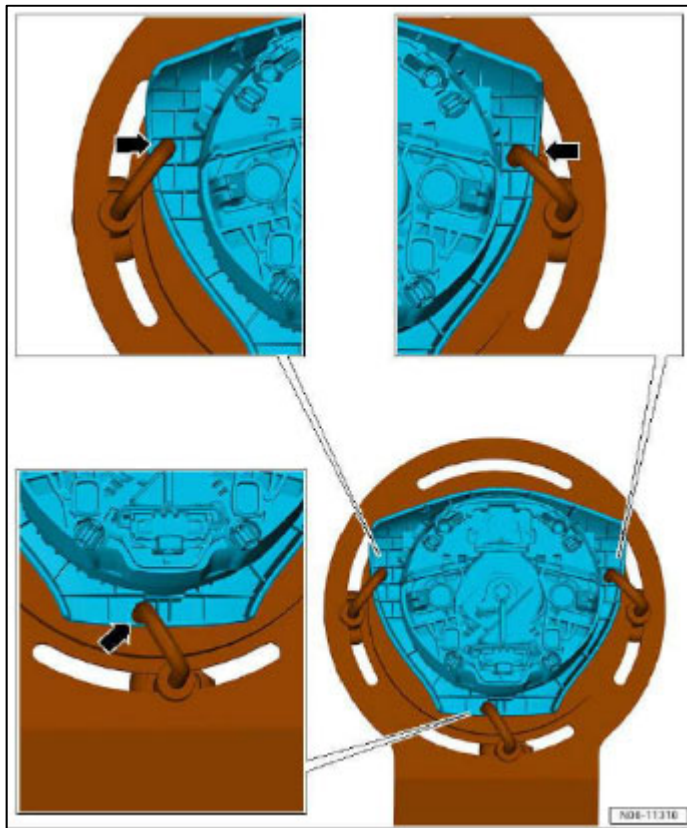

- Clamp airbag centrally in airbag support. There are securing points on the sides <arrows>, parallel opposite each other and below.

! NOTE

The clamps must be placed in the positions shown <arrows> to prevent damage to the airbag. Damage to the airbag is not covered under this action.

NOTE

The style of barcode has no bearing on the following installation instructions.

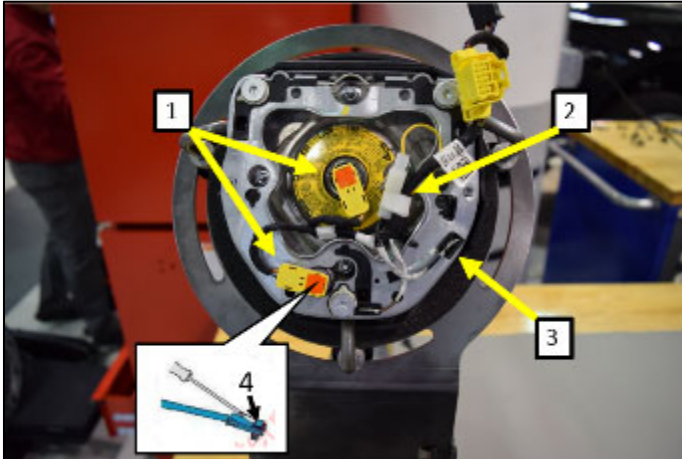

- Disconnect connector <1> using a small flat bladed screwdriver to disengage connector lock <4>.
- Disconnect connectors <2 and 3>.

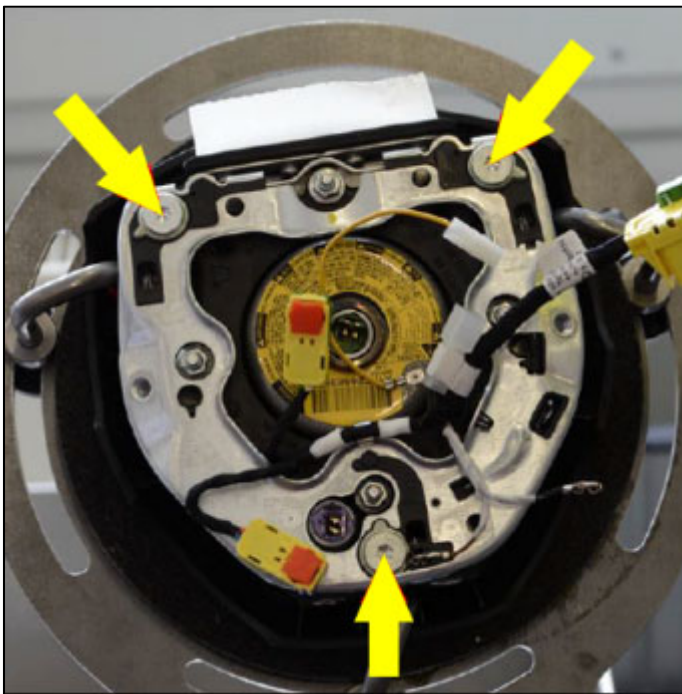

- Remove and discard the three horn ring bolts <arrows>.
- Remove the horn ring.

CAUTION

When removing the horn ring, take care that the springs are not lost as they are not available separately. Replacement of the airbag is required if a spring is lost and is not covered under this action.

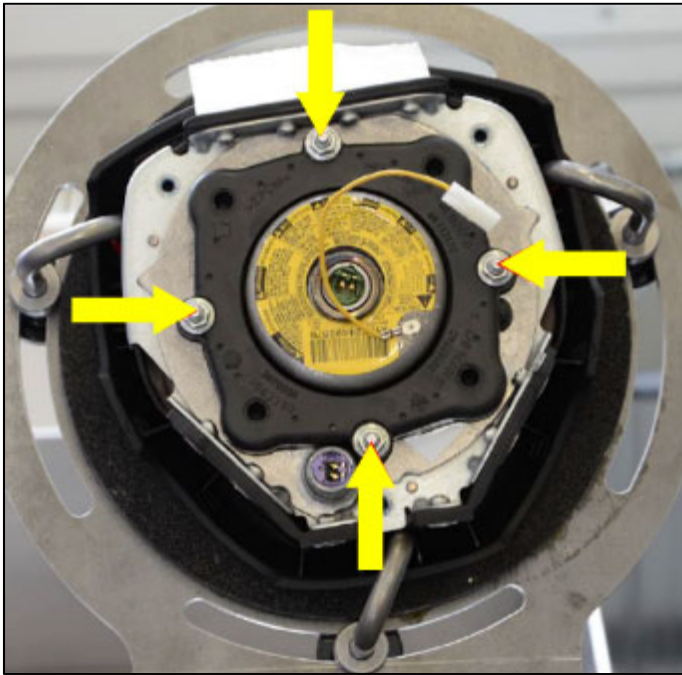

- Remove and discard the four nuts <arrows>.

NOTE

Inflator with vibration absorption shown. The photo is for reference only.

- Remove the inflator and place in the original packaging.

NOTE

Inflator return instructions are included with the new inflator.

Inflator versions WITH vibration absorption (Criteria 02, 03):

- Install the new inflator onto the studs.

Part Number	Part Description
8R0898201C	Inflator Kit – Criteria 02
8F0898201A	Inflator Kit – Criteria 03

- Ensure the recess on the inflator lines up properly with the tab on the airbag <arrow>.

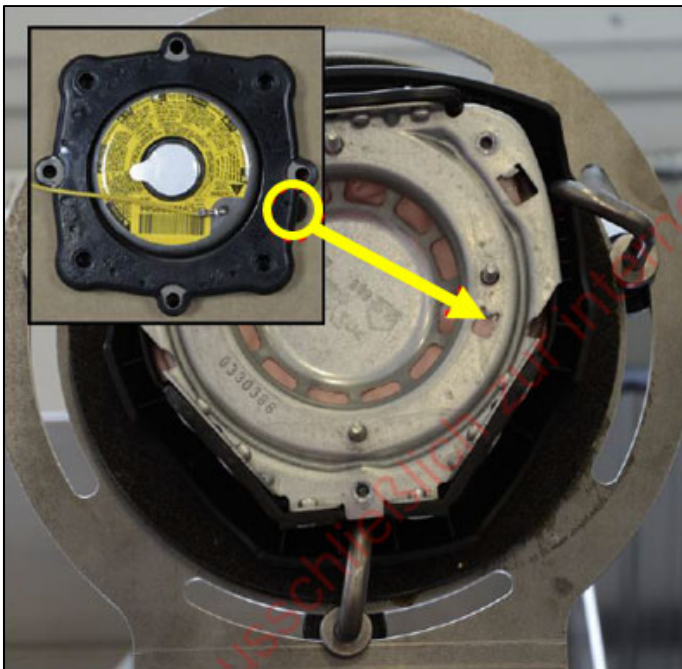

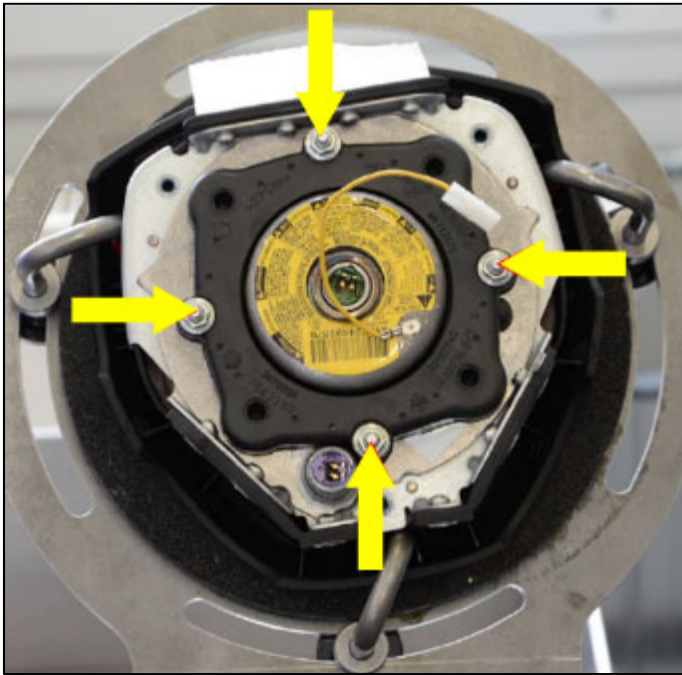

- Install the new inflator and torque nuts <arrows> to 4.5 Nm.

**Inflator versions WITHOUT vibration absorption
(Criteria 01):**

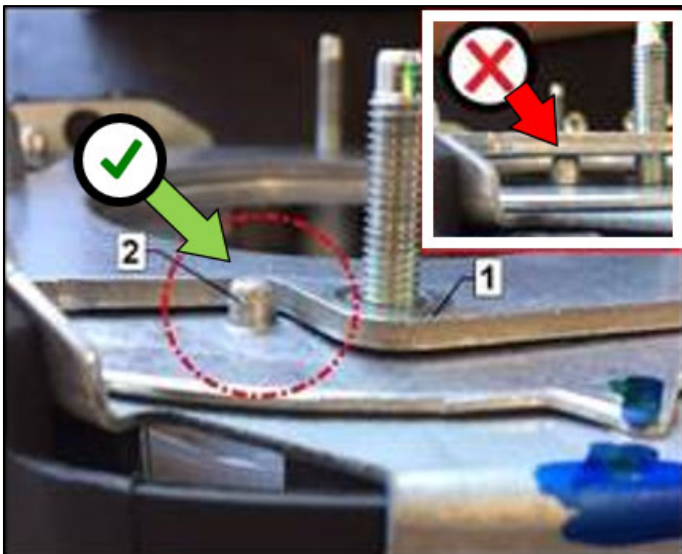

⚠ DANGER

The inset illustrates the plate resting on the tab. Failure to install the plate properly could cause improper airbag operation.

- Install the plate included in the kit so that the recess on the plate <1> aligns with the tab <2> on the airbag.

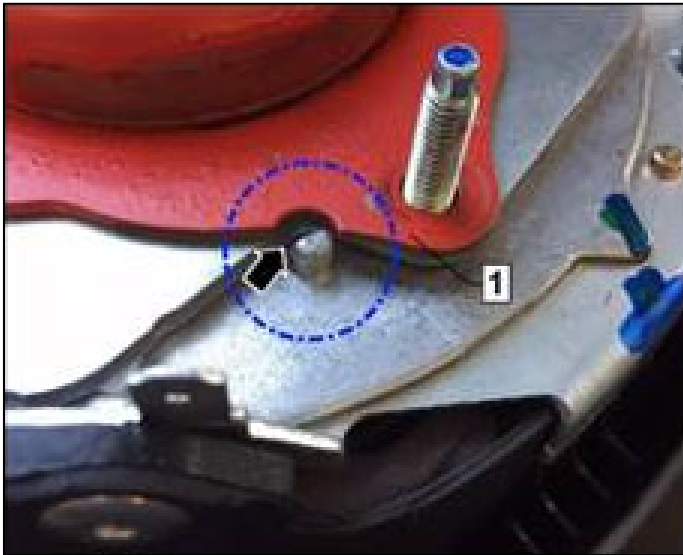

- Install the new inflator onto the studs.

Part Number	Part Description
8R0898201B	Inflator Kit – Criteria 01

- Ensure the recess on the inflator <1> lines up properly with the tab on the airbag <arrow>.

NOTE

In the event an airbag had previously been replaced, the replacement airbag may have an inflator WITH the vibration absorber. If this situation is encountered, the inflator WITH vibration absorption (part # 8R0898201C) MUST be installed:

- Do not install the plate included in the 8R0898201B kit.
- Repackage the previously scanned inflator and return to the parts department.
- Acquire the correct inflator (part # 8R0898201C) from the parts department.
- Scan the new inflator using the GFF test plan.
- Install the new inflator, following the **“Inflator versions WITH vibration absorption (Criteria 02, 03)”** instructions.

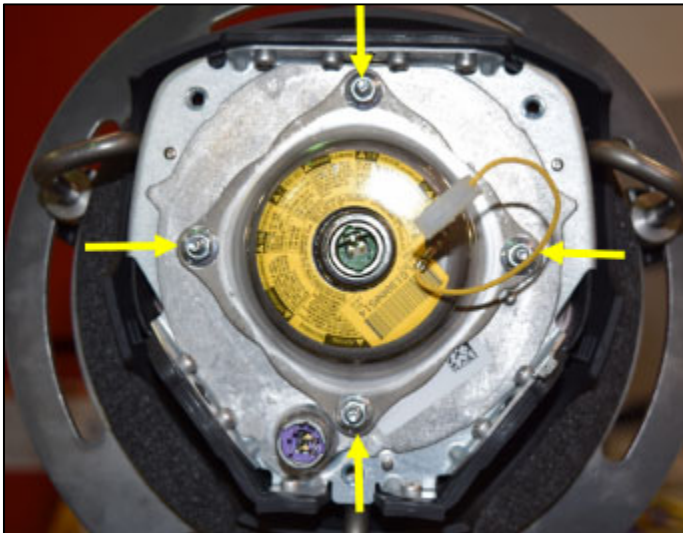

- Install the new inflator nuts <arrows> and torque to 4.5 Nm.

CONTINUED FOR ALL INFLATOR VERSIONS:

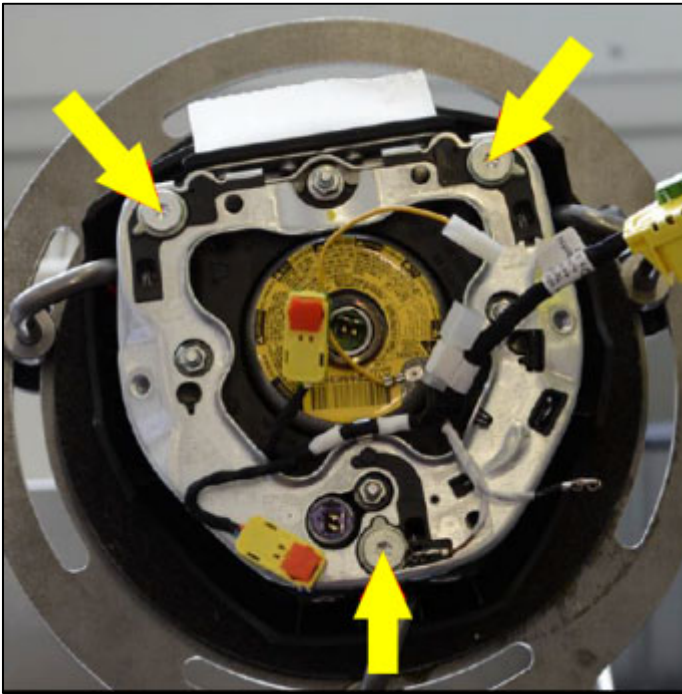

- Install the horn ring and tighten the bolts <arrows> to 6 Nm.

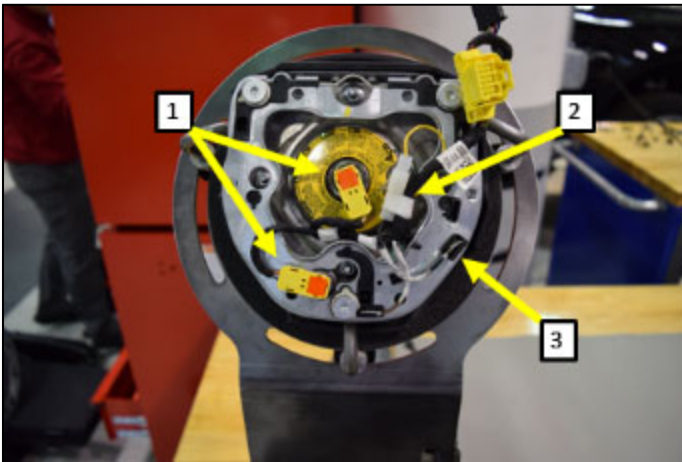

- Install connectors <1, 2 and 3>.

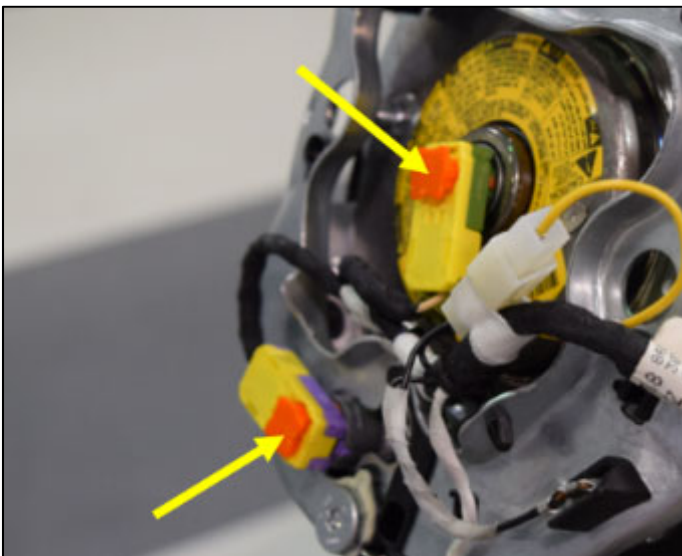

NOTE

Ensure the connector locks <arrows> are fully opened as shown when installing the connectors.

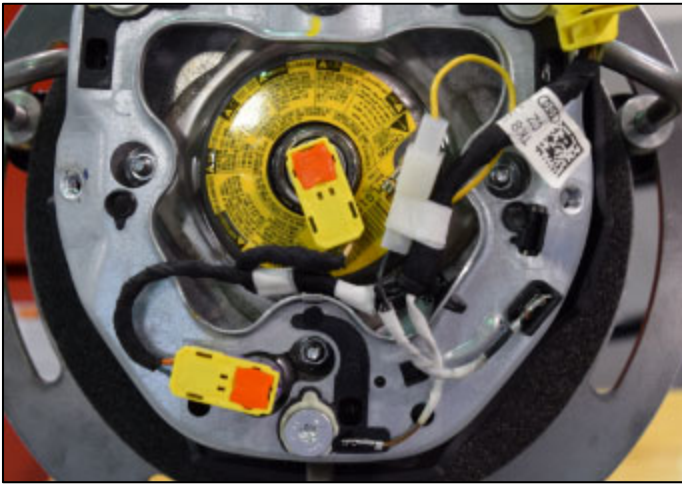

- Engage the connector locks.
- Ensure all wire connections are secure and the airbag harness is routed correctly.

Continue to Section F.

Section F – Airbag Installation

Vehicles with Criteria 06 through 20: Install a new driver airbag (see “Required Parts” section).

Bolted Airbag Version

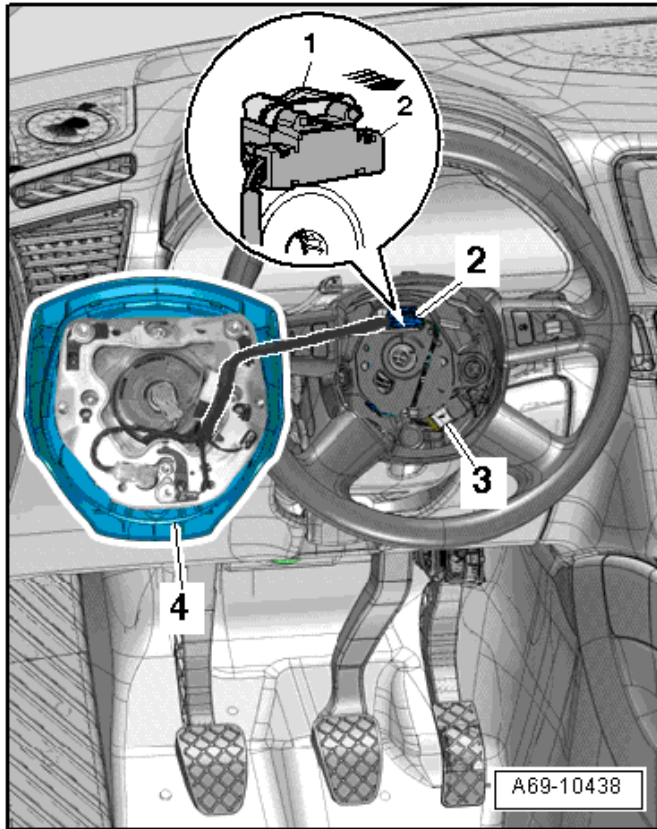

⚠ WARNING

- The battery must be disconnected before installing the airbag back into the vehicle.
- Before handling pyrotechnic components (for example, disconnecting the connector), the person handling it must “discharge static electricity”. This can be done by touching the door striker, for example.
- Connect the spiral spring electrical connector <2> with the airbag connector coupling on the coil connector with slip ring.
- Versions with Multi-function and Tiptronic steering wheel: Install the connector <3>.

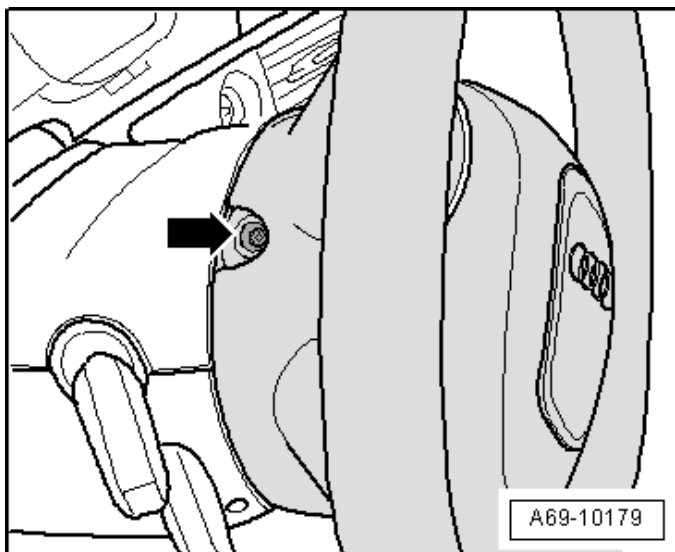

- Position the driver airbag in the steering wheel.
- Install the 2 bolts <arrow> for securing the driver airbag approximately 2 turns.
- Press horn about 3 times to achieve even gap dimension
- Torque the bolts <arrow> to 7 Nm.
- Install the bolt cover caps.

Continue to Section G.

Attached Airbag Version

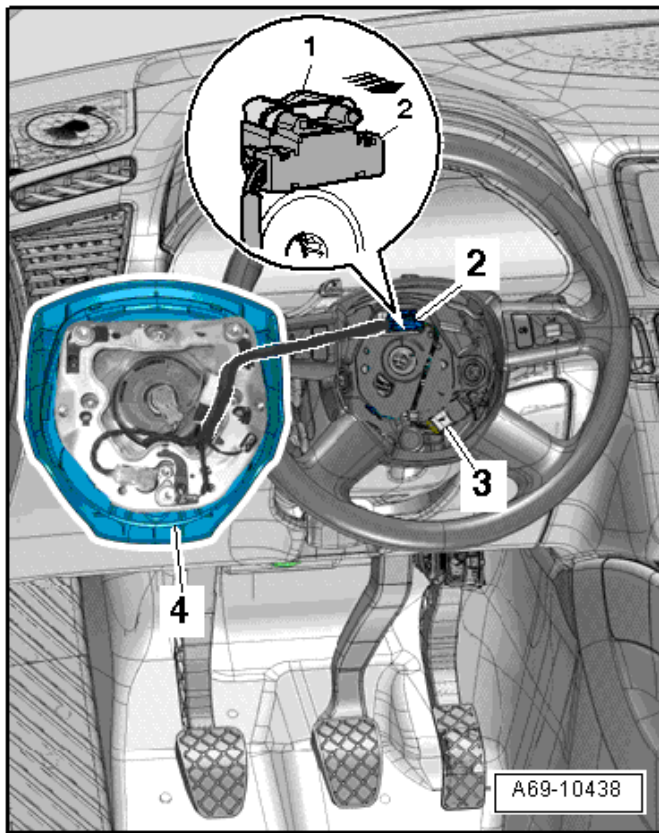

⚠ WARNING

- The battery must be disconnected before installing the airbag back into the vehicle.
- Before handling pyrotechnic components (for example, disconnecting the connector), the person handling it must “discharge static electricity”. This can be done by touching the door striker, for example.
- Connect the spiral spring electrical connector <2> with the airbag connector coupling on the coil connector with slip ring.
- Press in harness connector to secure in the pockets on the steering wheel.
- Position driver airbag in the steering wheel and press on it until it audibly engages.

Continue to Section G.

Section G – Battery Reconnect

A5 Cabrio Procedure

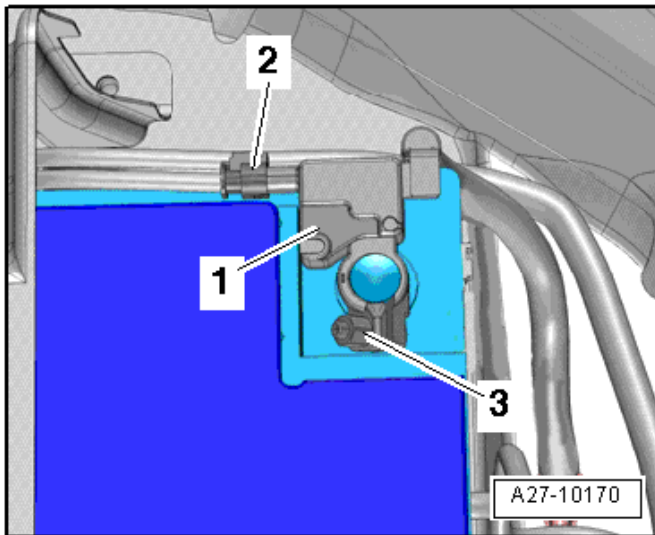

⚠ WARNING

Ignition must be ON when connecting battery. If pyrotechnic components (e.g. airbag, belt tensioner) are not repaired correctly, they may deploy unintentionally after connecting battery. There must not be anyone inside the vehicle when connecting the battery.

- Disconnect the connector <2> from the Battery Monitoring Control Module -J367- <1>.
- Connect the battery ground cable terminal by hand to the battery negative terminal.
- Torque the nut <3> to 6 Nm.
- Reconnect the connector to the Battery Monitoring Control Module -J367-.
- Install the battery terminal cover.

ⓘ NOTE

After connecting the power supply, the ABS warning lamp may only go out after the vehicle has been driven a few yards.

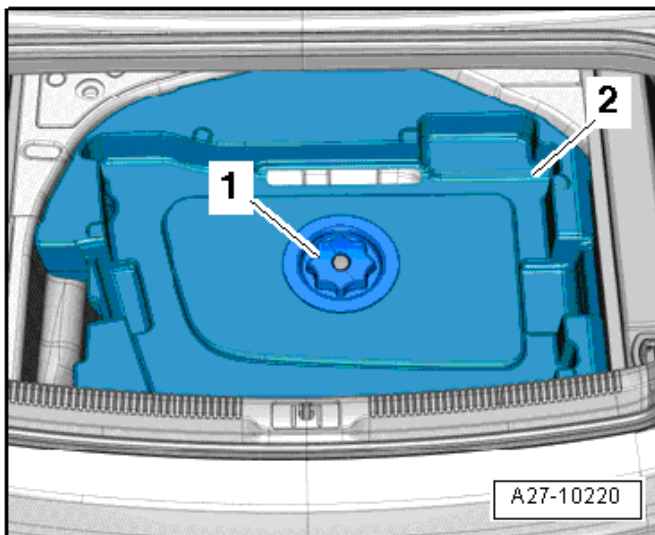

- Install the wind deflector mount <2>.
- Install the nut <1>.
- Install the luggage compartment floor.
- Cycle the ignition off and back on.
- Store previously recorded radio presets (if necessary).
- Set clock to local time.
- Activate the power window regulator one-touch up/down function.
- Check the DTC memories of all the control units and erase under-voltage faults if necessary.
- After completing repairs, verify the horn is operational.

ⓘ NOTE

Diagnosis and repair of an inoperable horn, before or after inflator replacement, will not be covered under this campaign.

Repair is complete, proceed to Section H.

Q5 Procedure

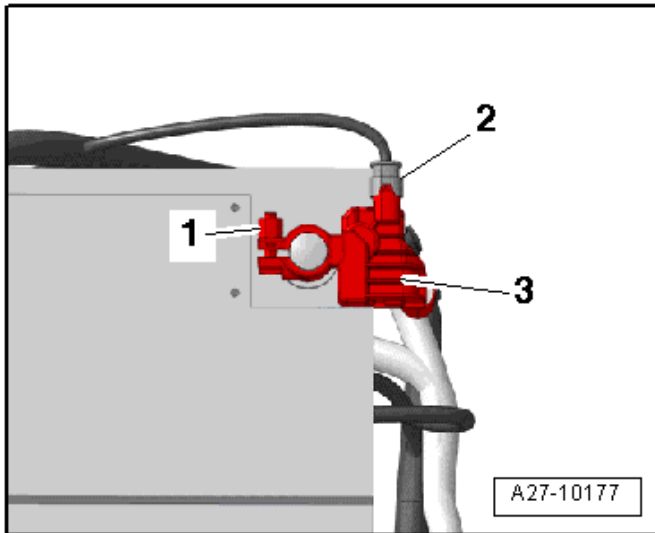

⚠ WARNING

- Ignition must be **ON** when connecting battery. If pyrotechnic components (e.g. airbag, belt tensioner) are not repaired correctly, they may deploy unintentionally after connecting battery. There must not be anyone inside the vehicle when connecting the battery.
- If the ignition is not switched on after reconnecting the battery (the indicator lamps in the instrument cluster do not illuminate), the ignition (key/button) may only be switched on while sitting in the driver's seat in the rearmost position.

- Disconnect the connector <2> from the Battery Monitoring Control Module -J367- <3>.
- Connect the battery ground cable terminal by hand to the battery negative terminal.
- Torque the nut <1> to 5 Nm.
- Reconnect the connector to the Battery Monitoring Control Module -J367-.

ⓘ NOTE

After connecting the power supply, the ABS warning lamp may only go out after the vehicle has been driven a few yards.

- Install battery terminal cover <1>.

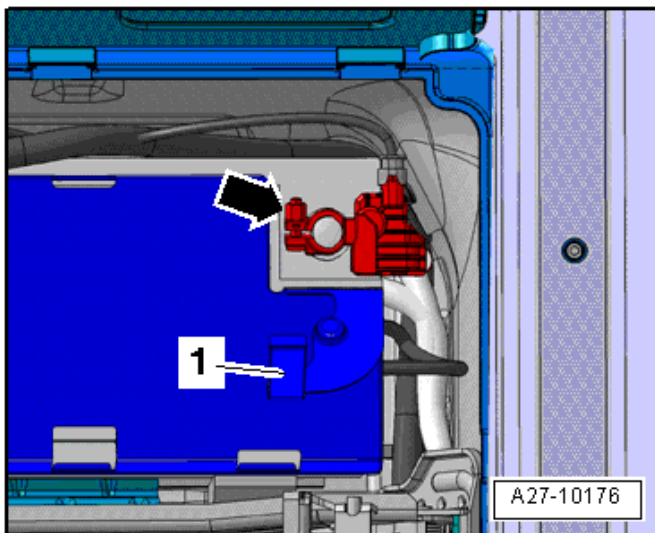

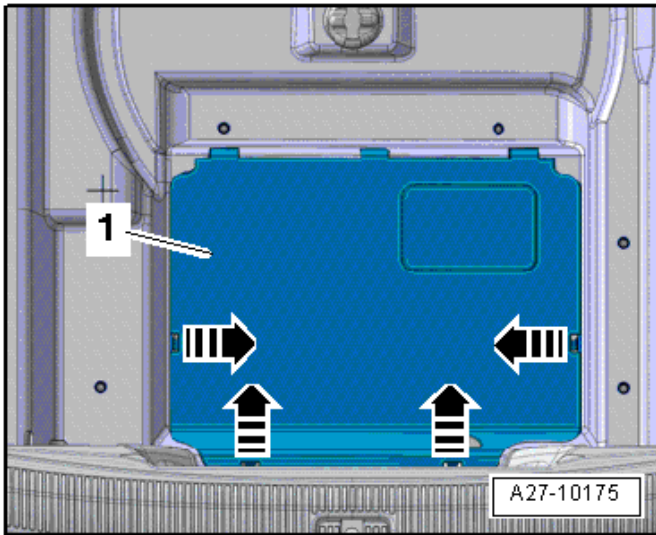

NOTE

The cover is available with varying numbers of retaining clips.

- Install cover <1>.

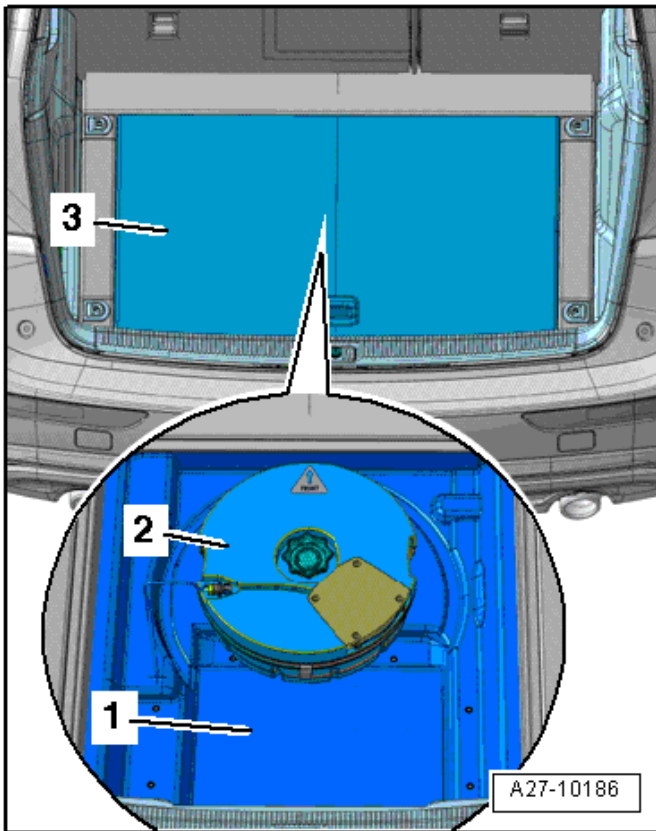

- Install the carpet <1> over the battery cover.
- If equipped, install the subwoofer <2>.
- Install the dirt tray, if applicable.
- Install the luggage compartment floor covering <3>.
- Cycle the ignition off and back on.
- Store previously recorded radio presets (if necessary).
- Set clock to local time.
- Activate the power window regulator one-touch up/down function.
- Check the DTC memories of all the control units and erase under-voltage faults if necessary.
- After completing repairs, verify the horn is operational.

NOTE

Diagnosis and repair of an inoperable horn, before or after inflator replacement, will not be covered under this campaign.

Proceed to Section H.

Section H – Campaign Completion Stamp

I certify that this campaign
has been performed in strict
accordance with the applicable
Audi repair procedure.

SAGA Code: _____
Technician: _____
Date: _____

Item#: AUD4927ENG

-OR-

Je certifie que cette
campagne de rappel a été
exécutée suivant les strictes
directives de réparation
d'Audi

Code de SAGA: _____
Technicien: _____
Date: _____

Item # AUD4927FRE

- Once the campaign has been completed, the technician should stamp the repair order.
- Stamps are available for ordering through the Compliance Label Ordering Portal.

Repair is Complete, Proceed to Appendix C
(Mandatory Takata Parts Return Process).

Appendix A – Warning and Safety Precautions

WARNING

General Safety Precautions when Working with Pyrotechnic Components:

- Pyrotechnic components always contain propellant that generates a gas during combustion. In some components, there is also a supply of pressurized gas to ensure this gas is generated
- This pressurized gas is stored under high pressure in a compressed gas container. Pyrotechnic components are triggered by electrical/mechanical igniters.
- Only trained personnel should perform testing, assembly and servicing work. Airbags do not have a replacement interval.
- Never check with test lamps, voltmeter or ohmmeters.
- Only check pyrotechnic components when they are installed in the vehicle using vehicle diagnosis, testing and information systems approved by the manufacturer.
- When working on pyrotechnic components and the airbag control module, disconnect the battery ground strap while the ignition is switched on. Then cover the negative terminal.
- Wait 10 seconds after disconnecting the battery.
- The ignition must be SWITCHED ON when connecting the battery. There should not be anyone inside the vehicle when doing this.
- Exception: vehicles with batteries in the passenger compartment. In this case, stay outside the range of the airbags and seat belts.
- Wash your hands after touching ignited pyrotechnic components from the restraint system.
- Do not open or repair pyrotechnic components. Use only new components to reduce the risk of injury.
- Do not install pyrotechnic components that have fallen onto a hard surface or show signs of damage.
- Discharge static electricity before handling pyrotechnic components, for example before disconnecting the electrical connector. This can be done by touching grounded metal objects such as the door striker pin.
- Install pyrotechnic components immediately after removing them from their transport packaging. If you must stop working, store the pyrotechnic component in its original transport packaging.
- Do not leave pyrotechnic components lying in the open unattended.
- Do not treat pyrotechnic components with grease, cleaning solutions or similar products.
- Do not expose pyrotechnic components to temperatures above 100 °C, even for brief periods of time.
- People in the immediate vicinity of the workplace must be protected from possible noise and projectiles.
- Pyrotechnic components can trigger unintentionally.
- In the event of deployment:
 - Single-stage inflators: allow airbag to cool down completely. Wait at least 10 minutes before handling.
- Two-stage inflators: wait for second airbag ignition. Allow airbag to cool down completely. Wait at least 10 minutes before handling.

Appendix B – Rental Car/Loaner FAQ

TAKATA AIRBAG CLASS ACTION SETTLEMENT DEALERSHIP FAQS

Q: What is an eligible class member entitled to under the Enhanced Rental Car/Loaner Program?

A: Under the Enhanced Rental Car/Loaner Program, VWGoA or Audi of America will provide a rental or loaner vehicle to every owner or lessee who (i) brings one of the covered recalled vehicles to a Volkswagen or Audi dealer for completion of the remedy of the recall and (ii) requests a rental/loaner vehicle while awaiting the remedy for the recall, while the remedy for the recall is in progress, or if there is a delay in performing the remedy for the recall on the affected vehicle.

Q: Is there any information a customer must provide to participate in the Enhanced Rental Car/Loaner Program?

A: The customer must provide adequate proof of insurance. If a rental car (as opposed to a loaner car) is provided, the customer must meet the applicable rental car company's guidelines, including age restrictions.

Q: How long will a rental or loaner car be provided to an eligible class member under the Enhanced Rental Car/Loaner Program?

A: The rental/loaner car will be available until the remedy for the recall is performed on the affected vehicle, at which time the rental/loaner vehicle must be promptly returned to the provider of the rental/loaner vehicle in the same condition (excepting ordinary wear and tear) as received. Absent extenuating circumstances, the rental/loaner vehicle must be returned when the recall is completed. And in no event will VWGoA or Audi of America pay for a rental car or provide a loaner for more than 7 days after the remedy for the recall is completed on a vehicle.

Q: How early can an eligible class member expect to be provided a rental/loaner car under the Enhanced Rental Car/Loaner Program?

A: The Enhanced Rental Car/Loaner Program will take effect no later than 30 calendar days following November 10, 2021, the date of the Court's issuance of an order preliminarily approving the Settlement.