

September 4, 2019

Version 7

Safety Recall: Takata Front Passenger's Airbag Inflator (Phase 3)

Supersedes 18-002, dated December 7, 2018 to revise the information highlighted in **yellow**

Following NHTSA direction, there are five phases based on three different zones.

If the iN VIN status inquiry directs you to do this campaign, follow the applicable procedure regardless of where the vehicle is currently located because it may have moved between different states. Make sure you file a claim using the correct warranty claim information to avoid your claim being rejected.

AFFECTED VEHICLES

Zone A

Year	Model	Trim	VIN Range
2009–12	Accord	ALL	Check the iN VIN status for eligibility
2010–13	Crosstour	ALL V6	Check the iN VIN status for eligibility
2012-13	Crosstour	ALL L4	Check the iN VIN status for eligibility
2009–11	Civic	ALL	Check the iN VIN status for eligibility
2009–11	Civic CNG	ALL	Check the iN VIN status for eligibility
2009–11	Civic Hybrid	ALL	Check the iN VIN status for eligibility
2009–11	CR-V	ALL	Check the iN VIN status for eligibility
2009–13	Fit	ALL	Check the iN VIN status for eligibility
2013	Fit EV	ALL	Check the iN VIN status for eligibility
2010–13	Insight	ALL	Check the iN VIN status for eligibility
2009–13	Pilot	ALL	Check the iN VIN status for eligibility

Zone A applies to model year 2009 through 2013 vehicles that are located **or ever registered in**: Alabama, California, Florida, Georgia, Hawaii, Louisiana, Mississippi, South Carolina, Texas, Puerto Rico, American Samoa, Guam, the Northern Mariana Islands (Saipan), and the U.S. Virgin Islands.

Zone B

Year	Model	Trim	VIN Range
2009–10	Accord	ALL	Check the iN VIN status for eligibility
2010	Crosstour	ALL V6	Check the iN VIN status for eligibility

CUSTOMER INFORMATION: The information in this bulletin is intended for use only by skilled technicians who have the proper tools, equipment, and training to correctly and safely maintain your vehicle. These procedures should not be attempted by "do-it-yourselfers," and you should not assume this bulletin applies to your vehicle, or that your vehicle has the condition described. To determine whether this information applies, contact an authorized Honda automobile dealer.

Year	Model	Trim	VIN Range
2009–10	Civic	ALL	Check the iN VIN status for eligibility
2009–10	Civic CNG	ALL	Check the iN VIN status for eligibility
2009–10	Civic Hybrid	ALL	Check the iN VIN status for eligibility
2009–10	CR-V	ALL	Check the iN VIN status for eligibility
2009–10	Fit	ALL	Check the iN VIN status for eligibility
2010	Insight	ALL	Check the iN VIN status for eligibility
2009–10	Pilot	ALL	Check the iN VIN status for eligibility

Zone B applies to model year 2009 through 2010 vehicles that are located **or ever registered in**: Arizona, Arkansas, Delaware, District of Columbia, Illinois, Indiana, Kansas, Kentucky, Maryland, Missouri, Nebraska, Nevada, New Jersey, New Mexico, North Carolina, Ohio, Oklahoma, Pennsylvania, Tennessee, Virginia, and West Virginia.

Zone C

Year	Model	Trim	VIN Range
2009	Accord	ALL	Check the iN VIN status for eligibility
2009	Civic	ALL	Check the iN VIN status for eligibility
2009	Civic CNG	ALL	Check the iN VIN status for eligibility
2009	Civic Hybrid	ALL	Check the iN VIN status for eligibility
2009	CR-V	ALL	Check the iN VIN status for eligibility
2009	Fit	ALL	Check the iN VIN status for eligibility
2009	Pilot	ALL	Check the iN VIN status for eligibility

Zone C applies to model year 2009 vehicles that are located in: Alaska, Colorado, Connecticut, Idaho, Iowa, Maine, Massachusetts, Michigan, Minnesota, Montana, New Hampshire, New York, North Dakota, Oregon, Rhode Island, South Dakota, Utah, Vermont, Washington, Wisconsin, and Wyoming.

REVISION SUMMARY

Under BACKGROUND and REPAIR PROCEDURE, the V-SMART tool was added.

REPAIR PROCEDURE TABLE OF CONTENTS

This bulletin has repair procedures for several vehicles. Make sure to use the applicable procedure for the vehicle you are working on.

Vehicle	Page
Accord and Crosstour (L4 and V6)	6
Civic, Civic CNG, and Civic Hybrid	18
CR-V	28
Fit and Fit EV	39

Vehicle	Page
Insight	50
Pilot	61

BACKGROUND

NHTSA and its independent expert reviewed the findings of three independent investigations into the Takata air bag inflator ruptures. According to NHTSA, the combination of time, high temperature fluctuations, and humidity contribute to the degradation of the propellant in the inflators. NHTSA has concluded that this degradation can cause the propellant to burn too quickly, creating more pressure than the inflator can withstand, and, in extreme cases, causing the inflator to rupture and send shrapnel through the airbag toward vehicle occupants. NHTSA is prioritizing the recall of airbag inflators based on the risk of injury or death to vehicle occupants.

In early September 2019, the V-SMART tool was shipped to your dealership. This tool is used to help validate the installation of the front passenger's airbag replacement inflator. **Beginning September 30, 2019**, V-SMART will be a required tool for the installation of the front passenger's airbag replacement inflator. V-SMART validation for each of these repairs will be required for any and all warranty claims to be paid for such repairs. Refer to the job aid *Using V-SMART* and the *Tech2Tech*® video "Using V-SMART" for more information.

For more information about these inflator recalls, go to www.safercar.gov and use keyword TAKATA.

NOTE

If the VIN status inquiry indicates that the vehicle is subject to any open safety recalls, including the driver's airbag inflator, make sure to also complete those recall repairs before returning the vehicle to the customer. If you are unable to complete any open recall, advise the customer of the recall status and when the recall could be completed.

Make sure you review this service bulletin for installation instructions and details about model applicability.

CUSTOMER NOTIFICATION

Owners of affected vehicles will be sent a notification of this campaign.

Do an iN VIN status inquiry to make sure the vehicle is shown as eligible.

Some vehicles affected by this campaign may be in your used vehicle inventory.

Failure to repair a vehicle subject to a recall or campaign may subject your dealership to claims or lawsuits from the customer or anyone else harmed as a result of such failure. To see if a vehicle in inventory is affected by this safety recall, do a VIN status inquiry before selling it.

CORRECTIVE ACTION

Replace the passenger's airbag inflator, then return the original, undeployed inflator as directed.

PARTS INFORMATION

Part Name	Order Part Number	You may receive any of the following	Quantity
2009–12 Accord Front Passenger's Airbag Inflator Kit	04790-TA0-407	04790-TA0-407 04790-TA0-A00	1
2010–13 Accord Crosstour (V6 & L4) Front Passenger's Airbag Inflator Kit	04790-TA0-407	04790-TA0-407 04790-TA0-A00	1

Part Name	Order Part Number	You may receive any of the following	Quantity
2009–11 Civic Front Passenger’s Airbag Inflator Kit (Applies Civic, Civic CNG and Civic Hybrid)	04790-SNA-407	04790-SNA-407 04790-SNA-A00	1
2009–11 CR-V Front Passenger’s Airbag Inflator Kit	04790-SWA-407	04790-SWA-407 04790-SWA-A00	1
2009–13 Fit & 2013 Fit EV Front Passenger’s Airbag Inflator Kit	04790-TK6-407	04790-TK6-407 04790-TK6-A00	1
2010–13 Insight Front Passenger’s Airbag Inflator Kit	04790-TM8-407	04790-TM8-407 04790-TM8-A00	1
2009–13 Pilot Front Passenger’s Airbag Inflator Kit	04790-SZA-407	04790-SZA-407 04790-SZA-A00	1

NOTES

- The inflator kit box must be used to return the recalled inflator to its supplier. Be careful not to damage the inflator kit box.
- If the recalled, undeployed inflator is not returned, the warranty claim for that vehicle will be charged back to your dealership.
- To return the undeployed inflators, follow the shipping instructions outlined in PIB A15-0002, Inflator Kit Return Process.
- Parts staff can scan the part number and serial number from the outside of the box into the warranty claim by using the Controlled Part Serial No. screen and scanning the applicable information. Refer to the Job Aid **Ordering and Managing Replacement Inflators** for more information.

REQUIRED TOOLS

Tool Name	Part Number	Quantity
PSPI6 Gauge Tool	070AJ-TA00A00 or 07AAJ-TA0AA00	1

NOTES

- Each dealer was sent over 10 tools. If you need more, the gauge is available for dealer ordering.
- This tool for use on the inflators with blue collars only.

WARRANTY CLAIM INFORMATION

NOTES

- Process claims as quickly as possible so that resources can be properly allocated.
- Enter the part number of the inflator that you received into the warranty claim, not the part number that you ordered. For more information, refer to step 6 of REPAIR PROCEDURE.
- To avoid non-payment of warranty claims, the serial number on the box of the new airbag inflator must be entered into the warranty claim. For more information, refer to step 6 of REPAIR PROCEDURE.

- To avoid a warranty claim being charged back to your dealership, you must return the recalled, undeployed inflator to its supplier. Follow the shipping instructions outlined in PIB A15-0002, Inflator Kit Return Process.
- The serial number is encoded into the bar code printed on the label inside of the box and on a label attached to the outside of the box. If your dealership uses a scanner, you can scan the serial number from either place into the claim.
- The part number is encoded into a barcode attached to the outside of the box. If your dealership uses a scanner, you can scan the part number into the claim.
- **If you confuse the serial number and part number when entering the claim information**, your claim will automatically be rejected.
- For more information about scanning and filing airbag inflator recall claims, refer to **Ordering and Managing Replacement Inflators**. From the iN, select **Service, Warranty, Warranty Claim**, then **Reference Guide**. Under **HOT TIPS/TOPICS**, select **Inflator Claims at a Glance**.
- Each VIN is assigned to a specific campaign. Make sure you file a claim using the correct warranty claim information to avoid your claim being rejected.

Replacing the front passenger's airbag inflator

Year/Model	Operation Number	Replacement Part Number	Flat Rate Time	Defect Code	Symptom Code	Template ID	Failed Part Number
2009–12 Accord	7541D1	04790-TA0-407	0.7 hr	6EC00	B0K00	A18002A	77820-TA0-A80ZC
		04790-TA0-A00	0.7 hr	6EC00	B0K00	A18002B	77820-TA0-A80ZC
2012–13 Crosstour (L4) 2010-13 Crosstour (V6)	7541D1	04790-TA0-407	0.7 hr	6EC00	B0K00	A18002C	77820-TA0-A80ZC
		04790-TA0-A00	0.7 hr	6EC00	B0K00	A18002D	77820-TA0-A80ZC
2009–11 Civic (Includes CNG & Hybrid)	7541D1	04790-SNA-407	0.8 hr	6EC00	B0K00	A18002E	77820-SNA-A82ZA
		04790-SNA-A00	0.8 hr	6EC00	B0K00	A18002F	77820-SNA-A82ZA
2009–11 CR-V	7541D1	04790-SWA-407	0.7 hr	6EC00	B0K00	A18002G	77820-SWA-A80ZA
		04790-SWA-A00	0.7 hr	6EC00	B0K00	A18002H	77820-SWA-A80ZA
2009–13 Fit 2013 FIT EV	7541D1	04790-TK6-407	0.9 hr	6EC00	B0K00	A18002I	77820-TK6-A80ZA
		04790-TK6-A00	0.9 hr	6EC00	B0K00	A18002J	77820-TK6-A80ZA
2010–13 Insight	7541D1	04790-TM8-407	0.6 hr	6EC00	B0K00	A18002K	77820-TM8-A80ZB
		04790-TM8-A00	0.6 hr	6EC00	B0K00	A18002L	77820-TM8-A80ZB
2009–13 Pilot	7541D1	04790-SZA-407	0.6 hr	6EC00	B0K00	A18002M	77851-SZA-A12
		04790-SZA-A00	0.6 hr	6EC00	B0K00	A18002N	77851-SZA-A12

Skill Level: Repair Technician

IDENTIFYING COUNTERFEIT AIRBAGS

This section goes over the steps to identify counterfeit airbags and applies to all vehicles in this service bulletin. It is referred to in each vehicle's repair procedure. Click [HERE](#) to watch a video to help identify counterfeit airbags.

- If there is nothing unusual about the airbag or the inflator, continue with the inflator replacement procedure.
- If there are any unusual markings, like an incorrect label or a model year written in marker, the airbag and inflator may not be the correct airbag and/or inflator for the vehicle or it may be a counterfeit part. For more information about counterfeit airbags, you can refer to safercar.gov, enter keywords **MANAGING COUNTERFEIT**, and select **Recommended Dealer Guidance for Managing Counterfeit Air Bags** from the list. **If you suspect that the airbag or inflator is counterfeit, do not continue this procedure.** Contact your DPSM for assistance

NON-STANDARD SAFETY LABEL

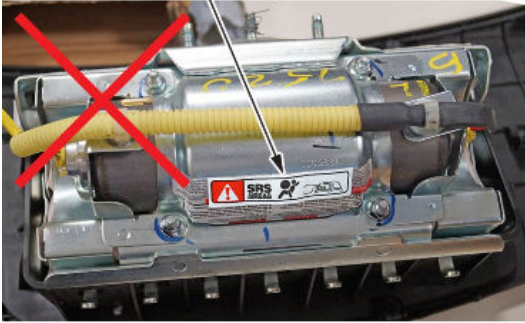

GREASE PENCIL OR PAINT MARKINGS

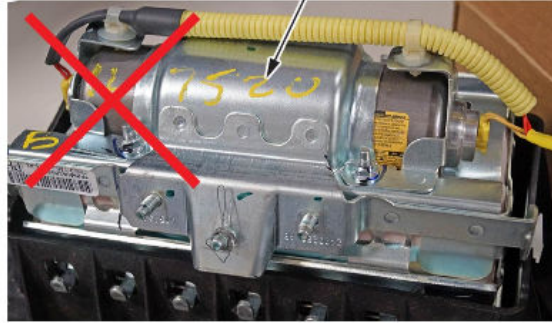

HAND ENGRAVING



NO LABELS ON INFLATOR

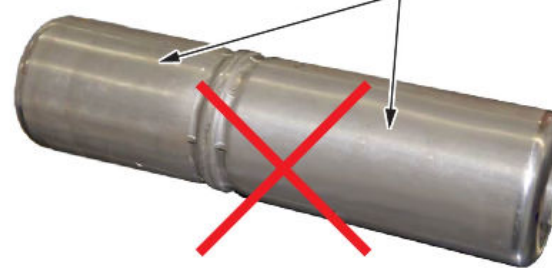

REPAIR PROCEDURE ACCORD AND ACCORD CROSSTOUR (L4 AND V6)

NOTES

- If the VIN status inquiry indicates that the vehicle is subject to any open safety recalls, including the driver's airbag inflator, make sure to also complete those recall repairs before returning the vehicle to the customer. If you are unable to complete any open recall, advise the customer of the recall status and when the recall could be completed.
 - Make sure you have the anti-theft code for the audio and navigation system (if applicable), then write down the frequencies for the radio's preset buttons.
 - Be careful not to damage any parts when replacing the inflator, and **follow the procedure exactly**.
 - If, before removing the airbag, you suspect that it may be the incorrect airbag for the vehicle or a counterfeit, **do not remove the airbag**. Contact your DPSM for assistance.
 - Make sure you have reviewed the SRS Precautions and Procedures in the service information before doing the REPAIR PROCEDURE.
1. Turn the ignition switch to the ON (II) position and check if the SRS indicator comes on for about 6 seconds, then turns off.
 - If the indicator comes on, then turns off after about 6 seconds, go to step 2.
 - If the indicator does not come on, or if it stays on, contact your DPSM for assistance.

2. Disconnect the battery negative cable and wait at least 3 minutes before continuing.
3. Remove the front passenger's airbag. Refer to the applicable vehicle's service information.
4. Place the airbag, face-down, on a clean shop towel.

NOTE

The orientation of the airbag is critical because if the inflator is installed incorrectly, the harness will be too short when you reinstall the airbag.

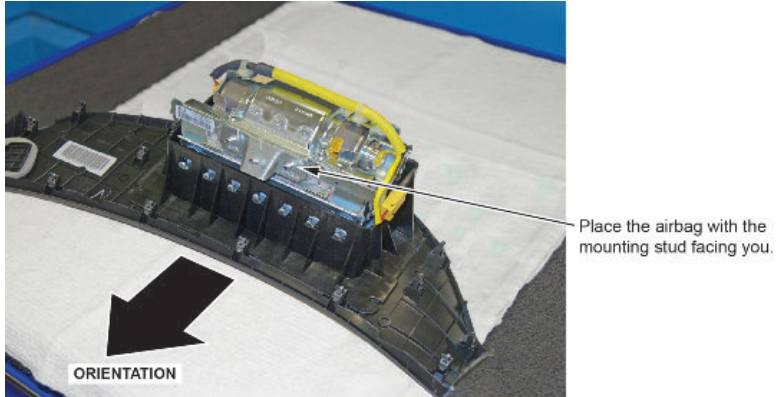

5. Visually inspect the airbag and the inflator for any unusual writing or markings. Refer to IDENTIFYING COUNTERFEIT AIRBAGS.

6. Peel the label located inside the inflator box from its backing and attach it to the RO. For the warranty claim to be paid, the **replacement inflator part number that you received** must be included in the warranty claim.

NOTES

- The replacement part number is printed on the top part of the label and the serial number is printed on the bottom. **Make sure you attach the label to the RO and give it to the warranty clerk .**
- There may also be a colored sticker located in the kit, ignore it because it is not used.
- Not all inflator kits have a label included. In those cases, write the serial number and part number from the side of the inflator box on the RO. The part number always starts with 047.

PASSENGER INFLATOR PARTS BOX

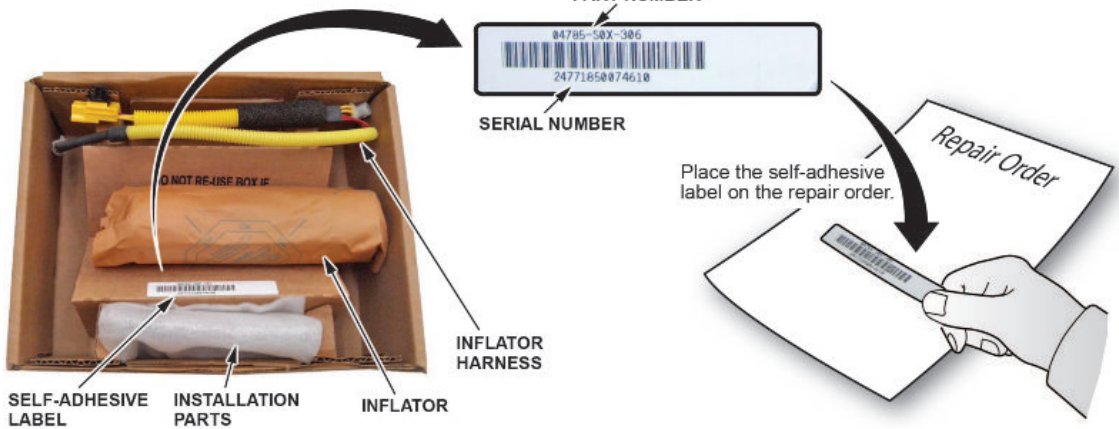

7. Remove the harness from both ends of the inflator bracket.

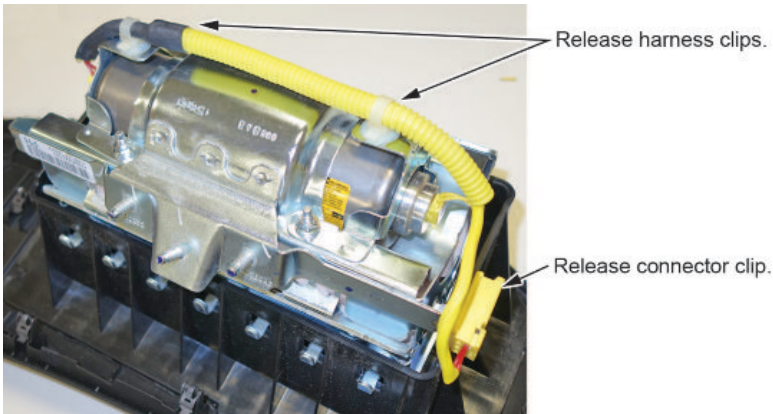

8. Short the yellow wires.

NOTES

- **You must cut and short the wires** as indicated to prevent accidental deployment.
- **Do not cut the red wires** because the airbag connector shorts these inflator wires.

8.1. Cut 1–2 inches of the protective tube to access the yellow wires.

Cut open the protective tubing to expose the yellow wires.

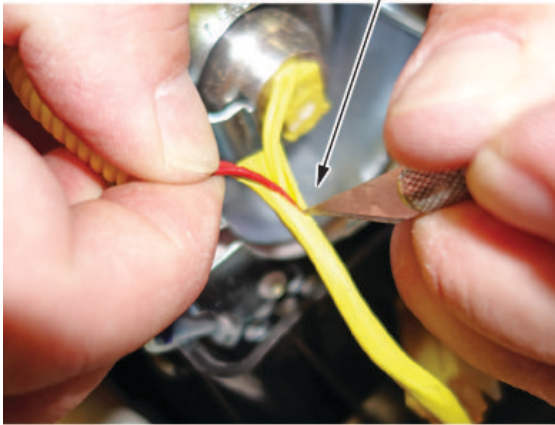

Expose enough of the yellow wires to easily cut.

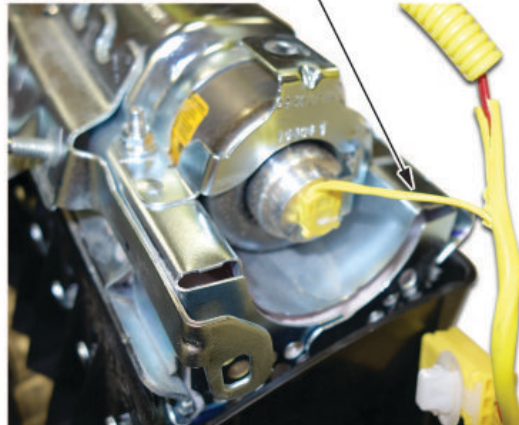

8.2. Cut the yellow wires as shown.

Cut the yellow wires on this side of the inflator.

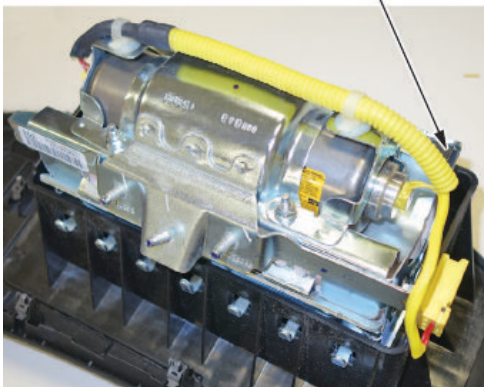

Cut only the yellow wires.

Do not cut the red wires.

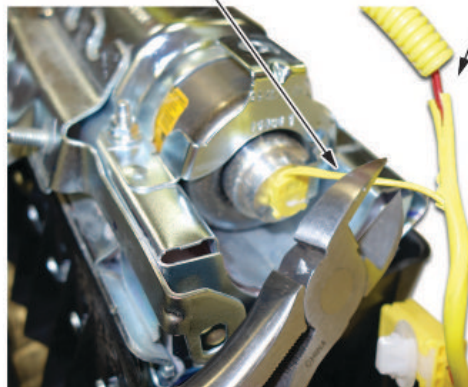

8.3. Strip away about 1 inch of the wire insulation, then twist the wires together.



Twist the ends together.

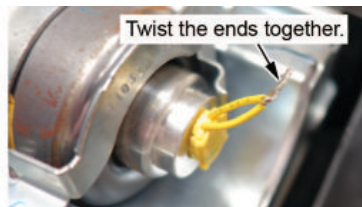

ELECTRICAL TAPE

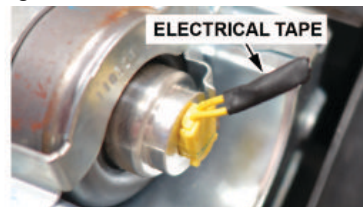

8.4. Tape the twisted ends with electrical tape.

9. Remove the four inflator nuts.

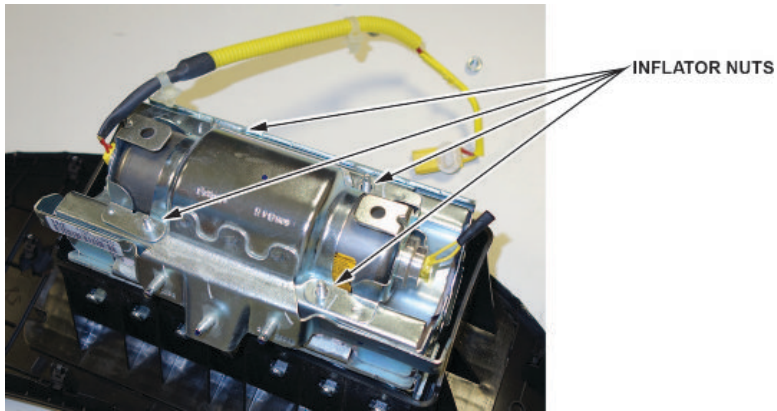

10. Remove the inflator bracket.

NOTE

You can only remove one of the brackets, as the other is welded to the airbag housing.

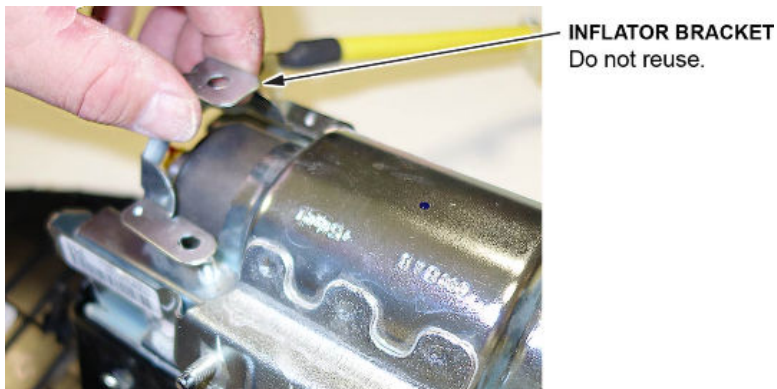

11. Remove the inflator by pushing it out.



12. Install the new inflator.

P/N 04790-TA0-407 or 04790-TA0-A00

NOTE

There may be some minor surface rust or corrosion on the new inflator; this is OK.

12.1. One side of the inflator has a longer collar, a single tab, a plastic cutout, and a small flat spot on the connector. The other side of the inflator has a shorter collar, two tabs, and a red dot. **Make sure you insert the end with the shorter collar into the airbag first.**

NOTES

- The V-SMART tool can only validate inflators with slotted end caps. You may receive an inflator with solid end caps. This is the correct part to repair the vehicle, but the V-SMART will fail the validation. **The V-SMART validation must fail a total of three times** before you can have your supervisor override the validation using the **Supervisor Inspection Override**.
- Your supervisor can be a service manager, shop foreman, team leader, etc. **The supervisor must inspect your work** to make sure the replacement inflator was installed correctly. When a supervisor enters his or her information, **the supervisor is signing off that the technician's work was inspected and approved.**

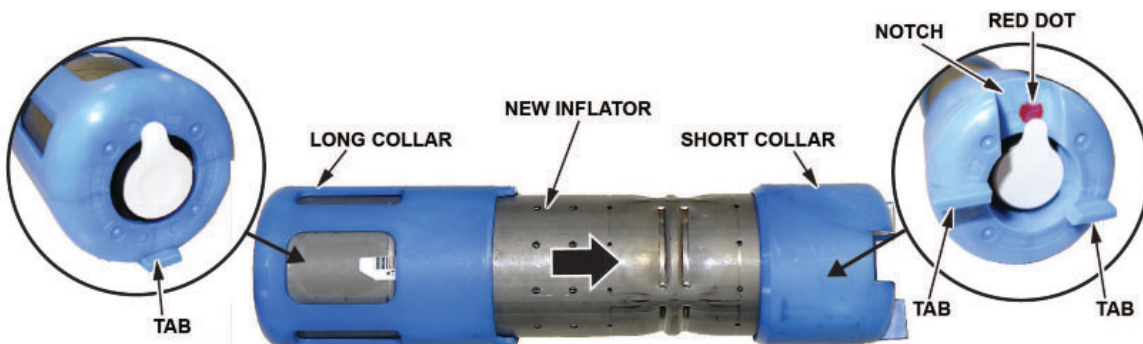

LONG COLLAR The inflator installation is directional.

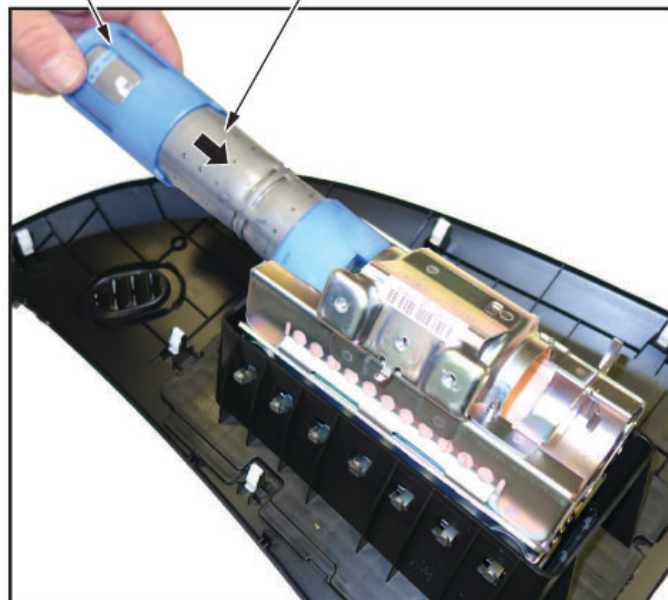

- 12.2. Slide the inflator in until the plastic cutout and the small flat spot align with the tab on the bracket. There should be no space or gap between the inflator and bracket. There is a red dot located on the fixed bracket side, which may be difficult to see because of the bracket.

FIXED BRACKET END

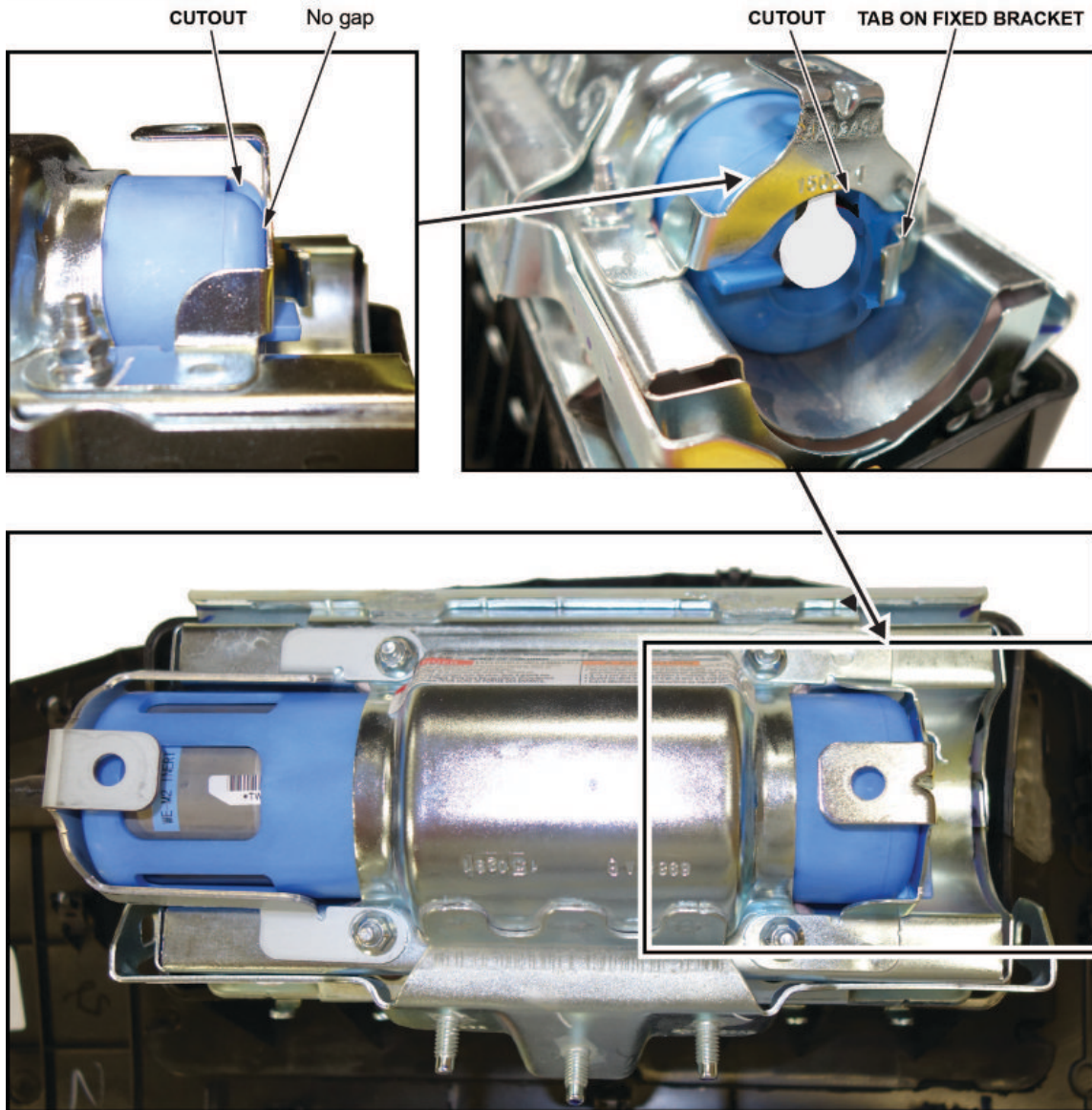

12.3. Install the bracket included in the kit onto the airbag module. There should be no space or gap between the inflator and bracket.

ADJUSTABLE BRACKET END

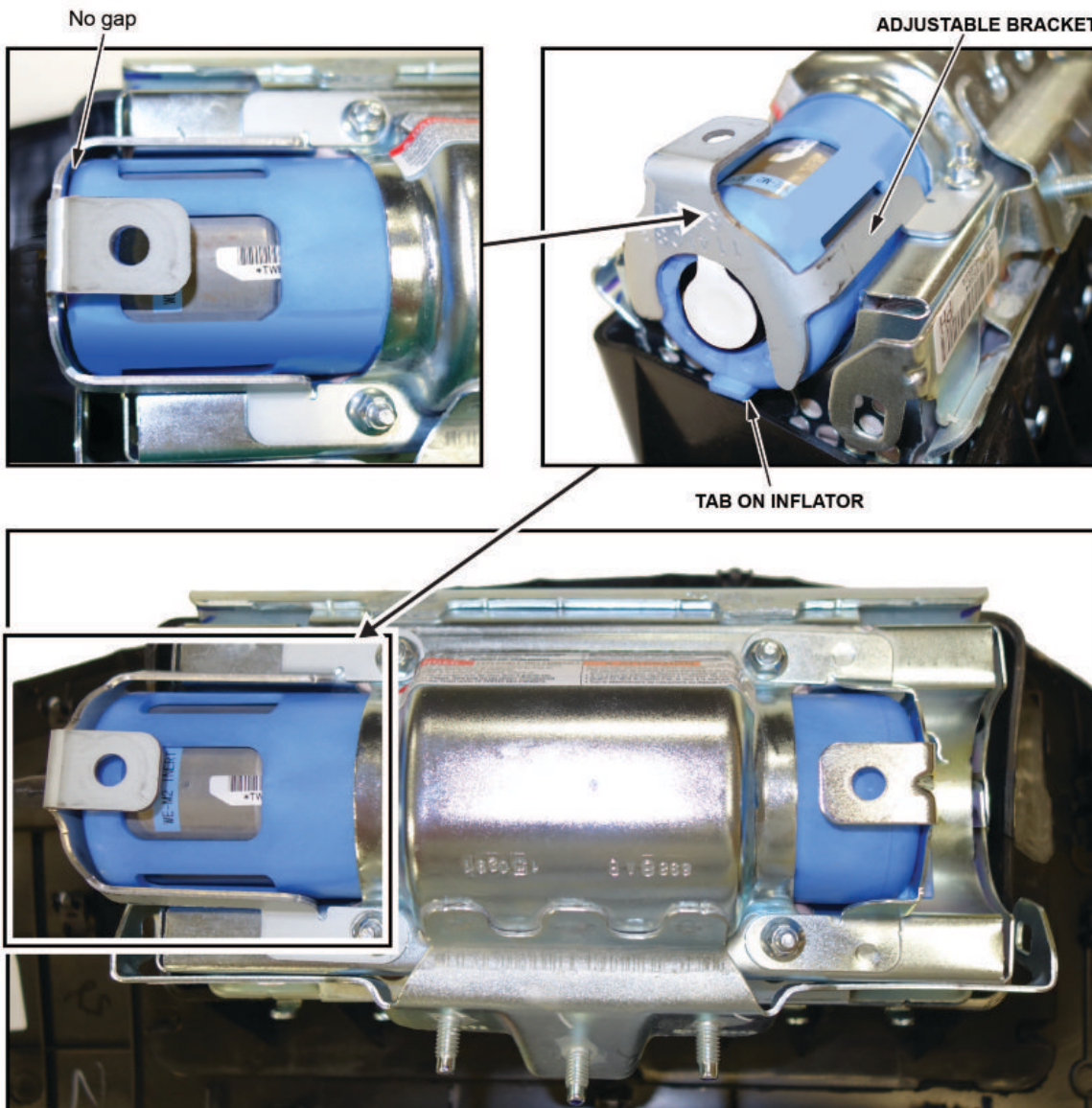

13. Install the new 5 mm locknuts and torque them in sequence to **3.9 N•m (34 lb-in)** .

Press the bracket in while tightening bolts.

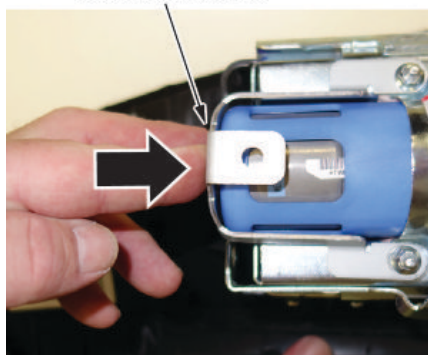

LOCK NUTS (4)
3.9 N•m (34 lb-in)

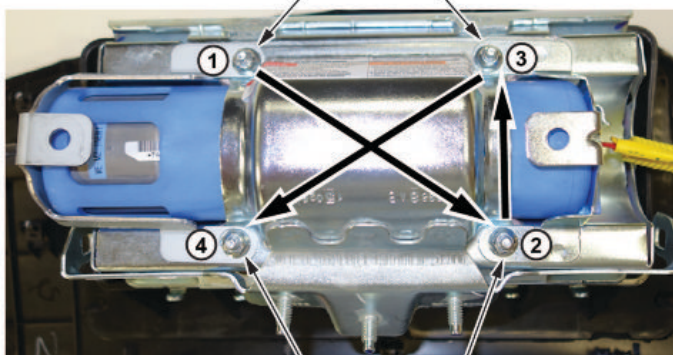

Be sure there are no gaps between the inflator ends and the inflator brackets.

14. Remove the stickers covering the terminals on both ends of the new inflator.

Remove the sticker.

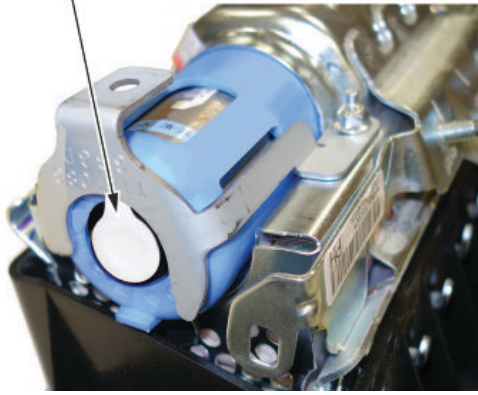

Remove the sticker.

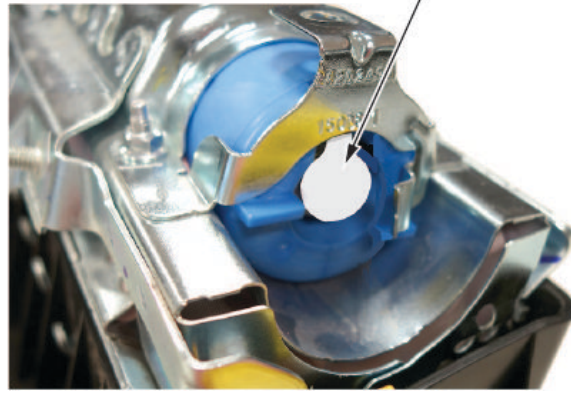

15. Using the V-SMART tool, validate that the airbag replacement inflator is installed correctly.

NOTES

- You must validate the front passenger's airbag replacement inflator installation using the V-SMART tool **before** connecting the inflator harness.
- Your warranty claim will not be paid if the V-SMART validation is not completed or the photo is not sent. Make sure you see the **Uploaded Completed** message to confirm the photo was sent to the warranty department.

16. Install the new inflator harness.

16.1. Make sure the airbag and harness are aligned as shown.

NOTES

- **Make sure you have the orientation correct as shown below.** If you connect the harness incorrectly, the harness cannot be removed, and you will not be able to reinstall the airbag because the harness will be too short.
- Connect the red wire connector to the **short collar side** of the inflator with the red dot.
- Connect the yellow wire connector to the **long collar side** of the inflator.
- The red dot may be difficult to see because of the bracket.

ORIGINAL INFLATOR HARNESS ROUTING

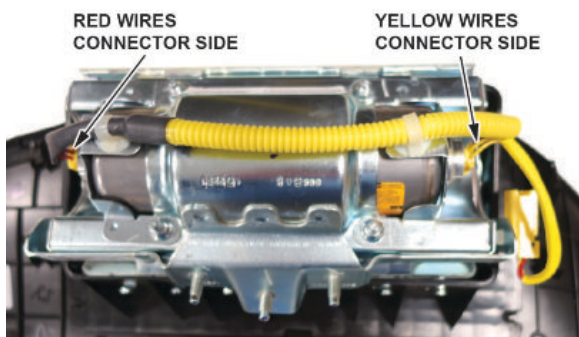

NEW INFLATOR HARNESS ROUTING

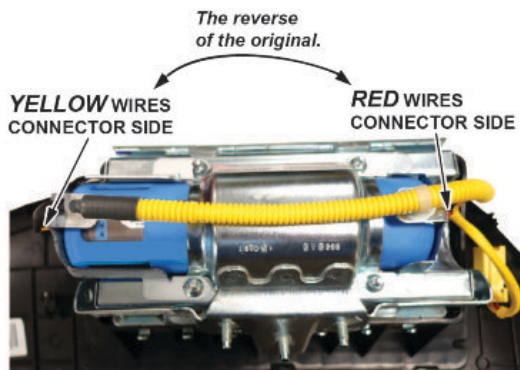

- 16.2. Connect the two connectors. Align the "T" shape in the inflator harness connector with the T-shaped inflator connector, then press the connector into place.

NOTE

Connect the red harness to the short collar side of the inflator with the red dot. The red dot may be difficult to see because of the bracket.

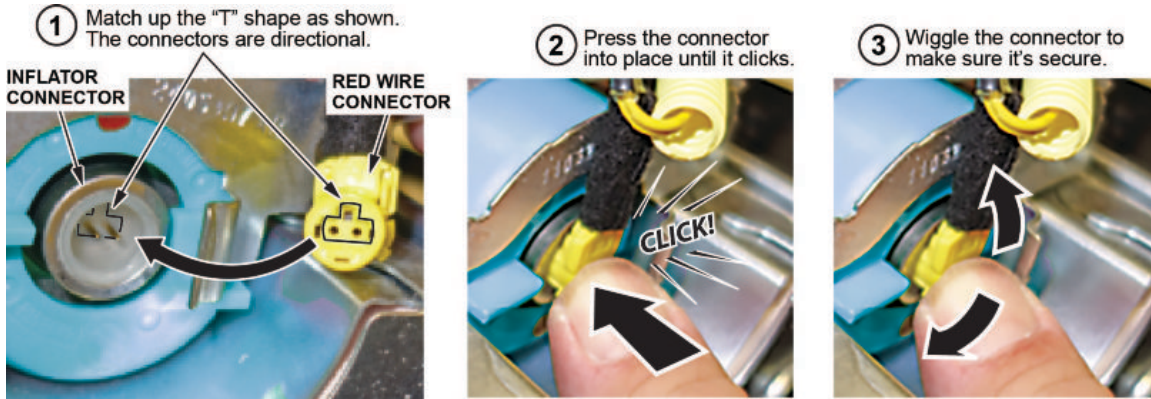

- 16.3. After you hear each connector click, wiggle it to make sure it is secure.

NOTE

If the connector is not properly aligned, it will come out.

- 16.4. Make sure the connector is secure and in place by using the gauge tool. (PSP16 Gauge Tool P/N: 070AJ-TA00A00 or 07AAJ-TA0AA00).

Be sure the connector is fully seated by checking it with the gauge tool.

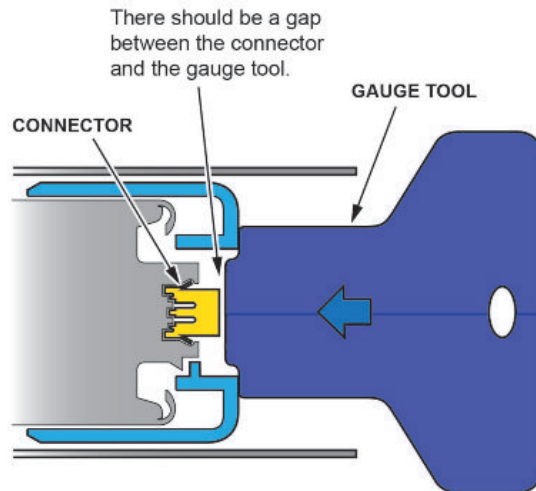
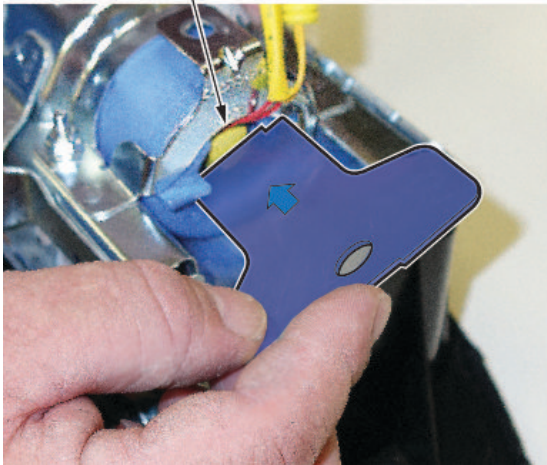

17. Connect the harness to the inflator brackets as shown.

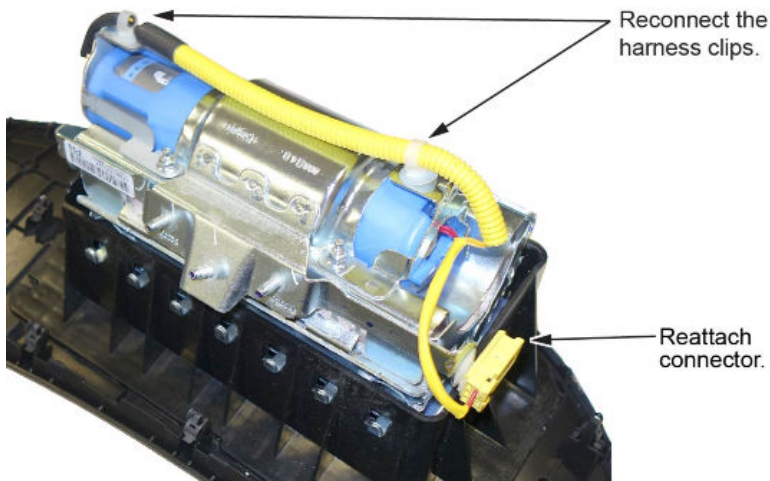

18. Reinstall the passenger's airbag into the vehicle and torque the new locknuts to **9.8 N•m (7.2 lb-ft)** .
19. Connect the battery negative cable and enter the anti-theft code for the audio and navigation system (if applicable), then enter the audio presets.
20. Set the clock (for vehicles without navigation).
21. Turn the ignition to ON and make sure the SRS indicator comes on for about 6 seconds, then goes off.
22. Put the original inflator into the box the new one came in. Make sure there is no other hardware in the box because if the package rattles, it will not be accepted by the courier.
23. Follow the shipping instructions outlined in PIB A15-0002 to return the undeployed inflator.
24. Give your warranty clerk the RO that includes the replacement inflator serial number and replacement part number. For the warranty claim to be paid, the **replacement inflator part number** must be included in the warranty claim.

NOTES

- If the VIN status inquiry indicates that the vehicle is subject to any open safety recalls, including the driver's airbag inflator, make sure to also complete those recall repairs before returning the vehicle to the customer. If you are unable to complete any open recall, advise the customer of the recall status and when the recall could be completed.
 - Make sure you have the anti-theft code for the audio and navigation system (if applicable), then write down the frequencies for the radio's preset buttons.
 - Be careful not to damage any parts when replacing the inflator, and **follow the procedure exactly**.
 - If, before removing the airbag, you suspect that it may be the incorrect airbag for the vehicle or a counterfeit, **do not remove the airbag**. Contact your DPSM for assistance.
 - Make sure you have reviewed the SRS Precautions and Procedures in the service information before doing the REPAIR PROCEDURE.
1. Turn the ignition switch to the ON (II) position and check if the SRS indicator comes on for about 6 seconds, then turns off.
 - If the indicator comes on, then turns off after about 6 seconds, go to step 2.
 - If the indicator does not come on, or if it stays on, contact your DPSM for assistance.
 2. Disconnect the battery negative cable and wait at least 3 minutes before continuing.
 3. Remove the front passenger's airbag. Refer to the applicable vehicle's service information.
 4. Place the airbag, face-down, on a clean shop towel.

NOTE

The orientation of the airbag is critical because if the inflator is installed incorrectly, the harness will be too short when you reinstall the airbag.

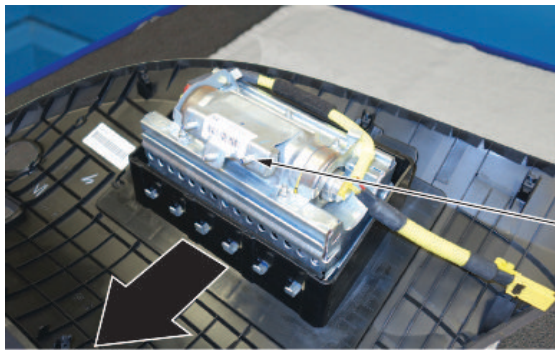

Place the airbag with the mounting studs facing you.

ORIENTATION

5. Visually inspect the airbag and the inflator for any unusual writing or markings. Refer to IDENTIFYING COUNTERFEIT AIRBAGS.

6. Peel the label located inside the inflator box from its backing and attach it to the RO. For the warranty claim to be paid, the **replacement inflator part number that you received** must be included in the warranty claim.

NOTES

- The replacement part number is printed on the top part of the label and the serial number is printed on the bottom. **Make sure you attach the label to the RO and give it to the warranty clerk .**
- There may also be a colored sticker located in the kit, ignore it because it is not used.
- Not all inflator kits have a label included. In those cases, write the serial number and part number from the side of the inflator box on the RO. The part number always starts with 047.

PASSENGER INFLATOR PARTS BOX

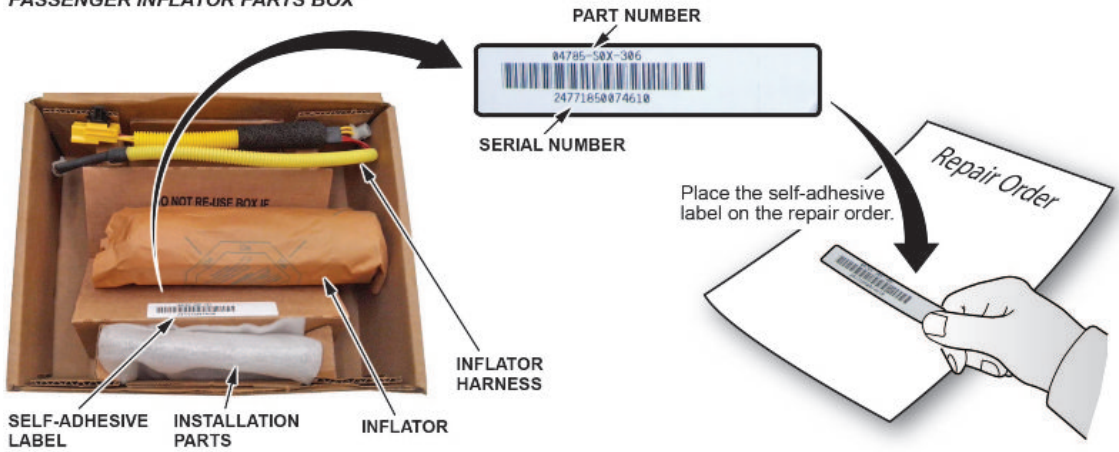

7. Remove the harness from both ends of the inflator bracket.
Release harness clips.

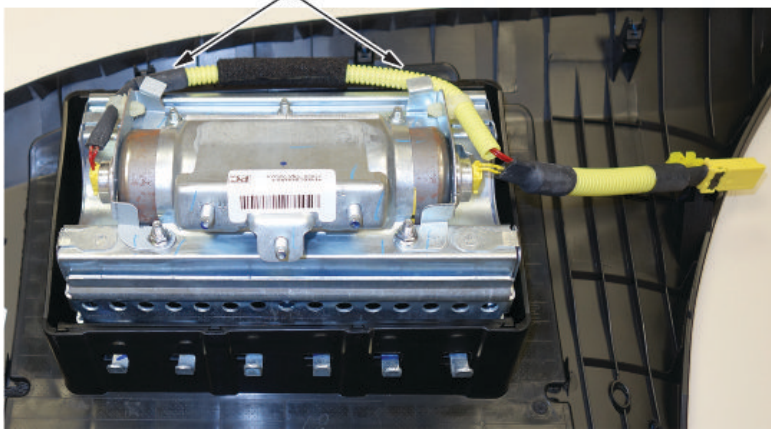

8. Short the yellow wires.

NOTES

- **You must cut and short the wires** as indicated to prevent accidental deployment.
- **Do not cut the red wires** because the airbag connector shorts these inflator wires.

8.1. Cut 1–2 inches of the protective tube to access the yellow wires.

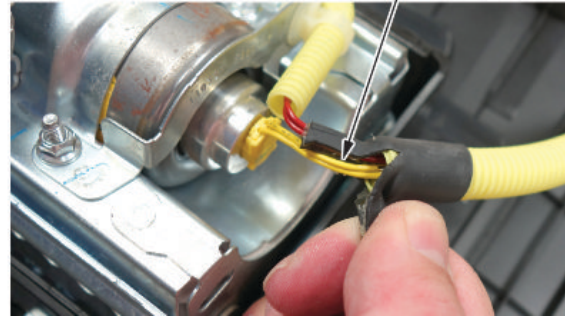

8.2. Cut the yellow wires as shown.

Cut the yellow wires on this side of the inflator.

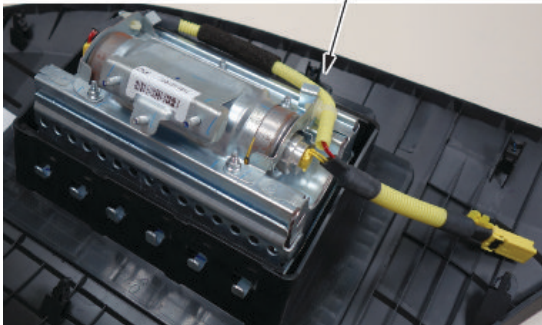

Cut only the yellow wires.

Do not cut the red wires.



8.3. Strip away about 1 inch of the wire insulation, then twist the wires together.

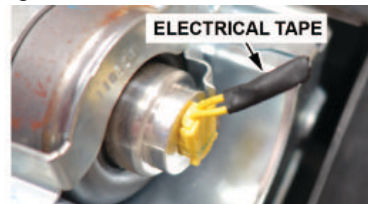

8.4. Tape the twisted ends with electrical tape.

9. Remove the four inflator nuts.

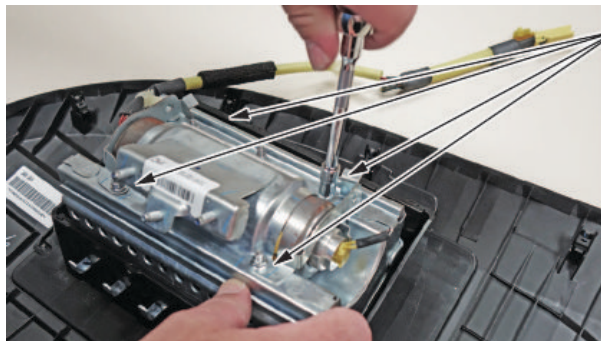

INFLATOR NUTS

10. Remove the inflator bracket.

NOTE

You can only remove one of the brackets, as the other is welded to the airbag housing.

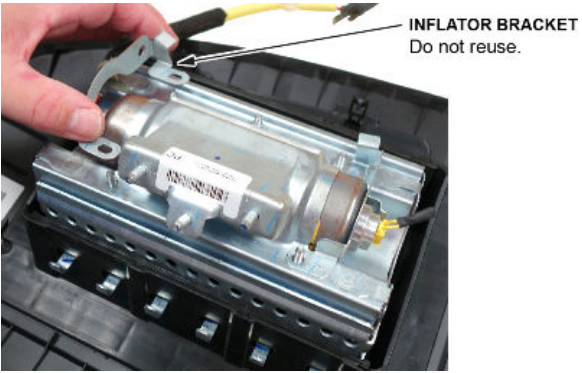

11. Remove the inflator by pushing it out.

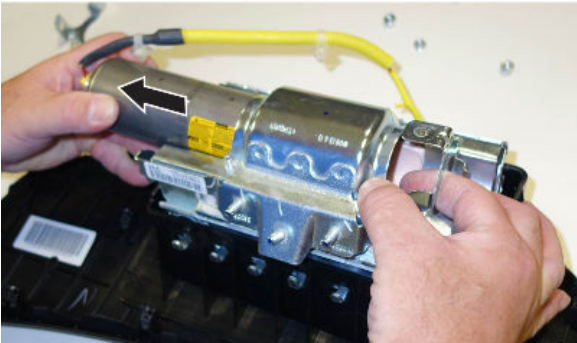

12. Install the new inflator.

NOTE

There may be some minor surface rust or corrosion on the new inflator; this is OK.

P/N 04790-SNA-407 or 04790-SNA-A00

12.1. One side of the inflator has a longer collar, a single tab, a plastic cutout, and a small flat spot on the connector. The other side of the inflator has a shorter collar, two tabs, and a red dot. **Make sure you insert the end with the shorter collar into the airbag first.**

NOTES

- The V-SMART tool can only validate inflators with slotted end caps. You may receive an inflator with solid end caps. This is the correct part to repair the vehicle, but the V-SMART will fail the validation. **The V-SMART validation must fail a total of three times** before you can have your supervisor override the validation using the **Supervisor Inspection Override**.
- Your supervisor can be a service manager, shop foreman, team leader, etc. **The supervisor must inspect your work** to make sure the replacement inflator was installed correctly. When a supervisor enters his or her information, **the supervisor is signing off that the technician's work was inspected and approved.**

CIVIC:

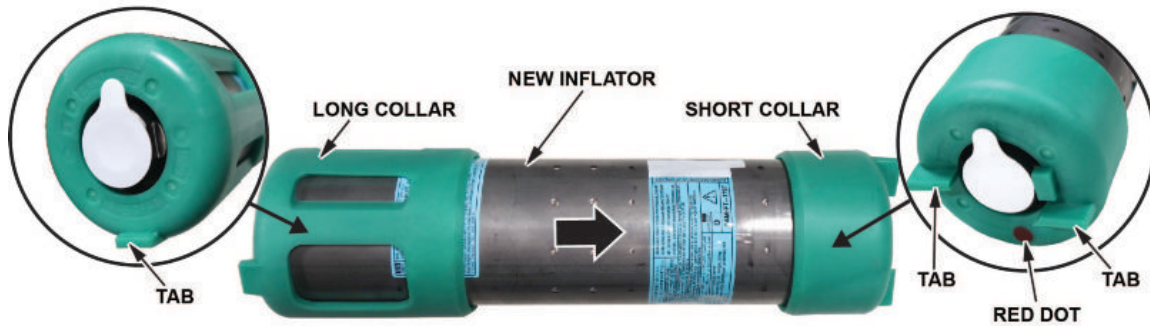

LONG COLLAR The inflator installation is directional.

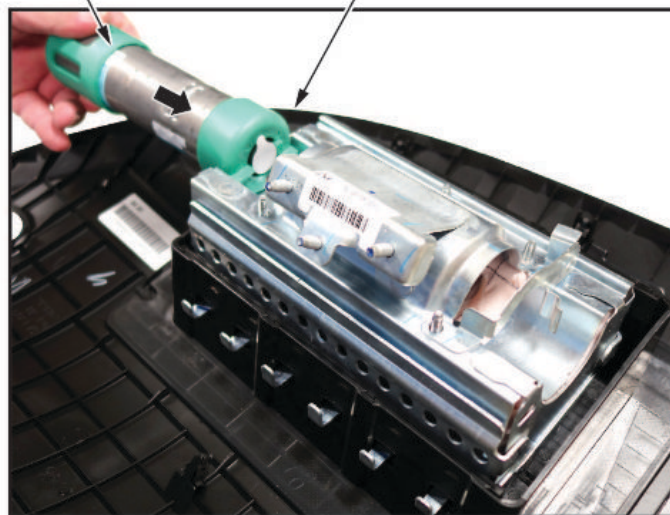

12.2. Slide the inflator in until the plastic collar contacts the bracket. The two tabs should align with the side of the airbag module and the metal tab as shown. There should be no space or gap between the inflator and bracket.

CIVIC:

FIXED BRACKET END

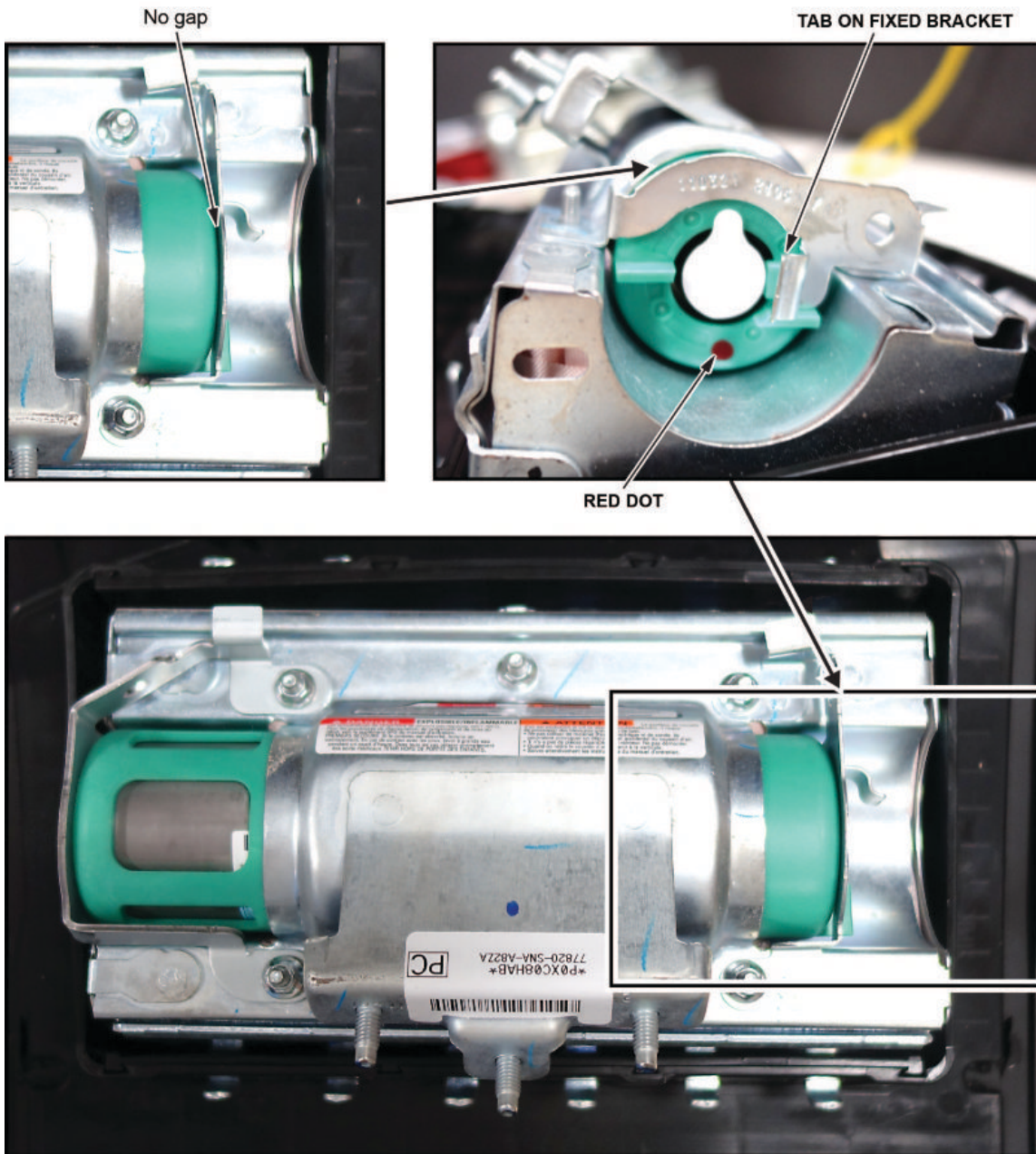

- 12.3. Install the new bracket included in the kit onto the airbag module. Check there is no space or gap between the inflator and bracket by pushing the bracket against the inflator.

NOTE

The bracket may have a little bit of play before you install the new nuts.

CIVIC:

ADJUSTABLE BRACKET END

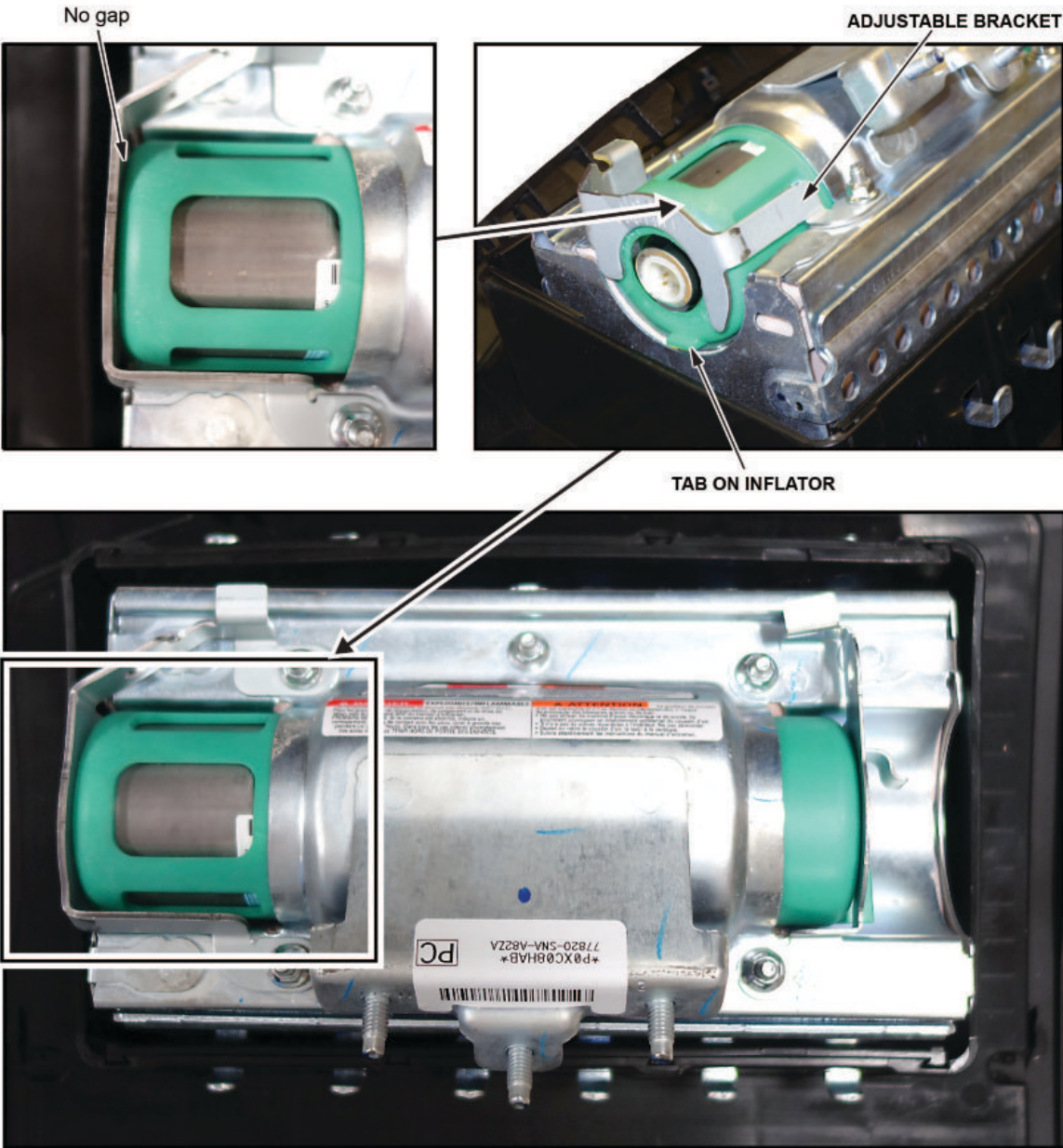

13. Hold the bracket against the inflator, then install the new 5 mm locknuts and torque them in sequence to **3.9 N•m (34 lb-in)**.

NOTE

Make sure you push the bracket against the inflator to ensure there are no gaps between the brackets and inflator when torquing the nuts.

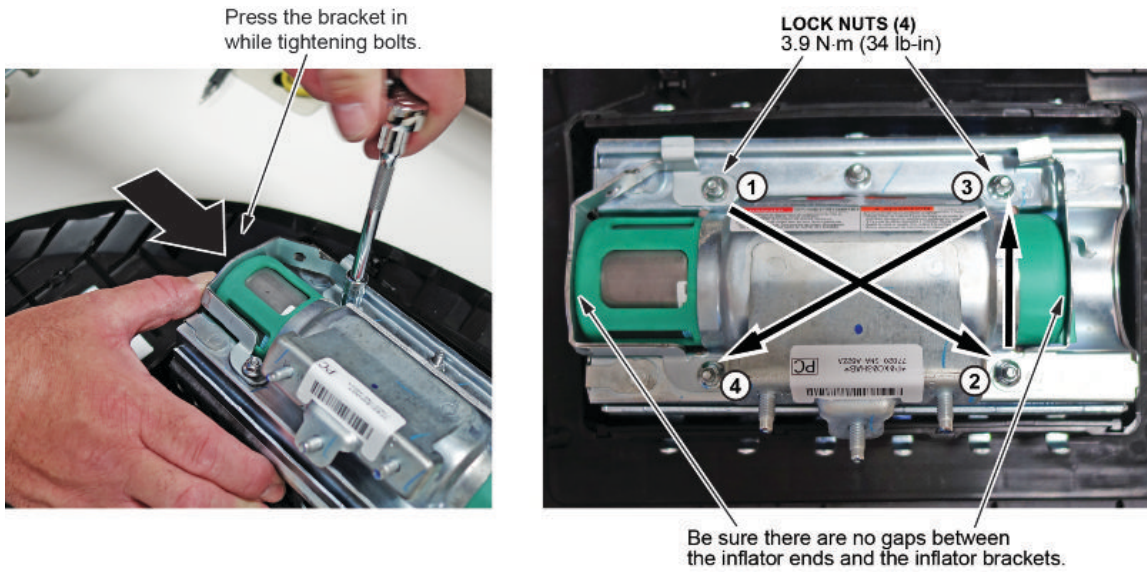

14. Remove the stickers covering the terminals on both sides of the new inflator.

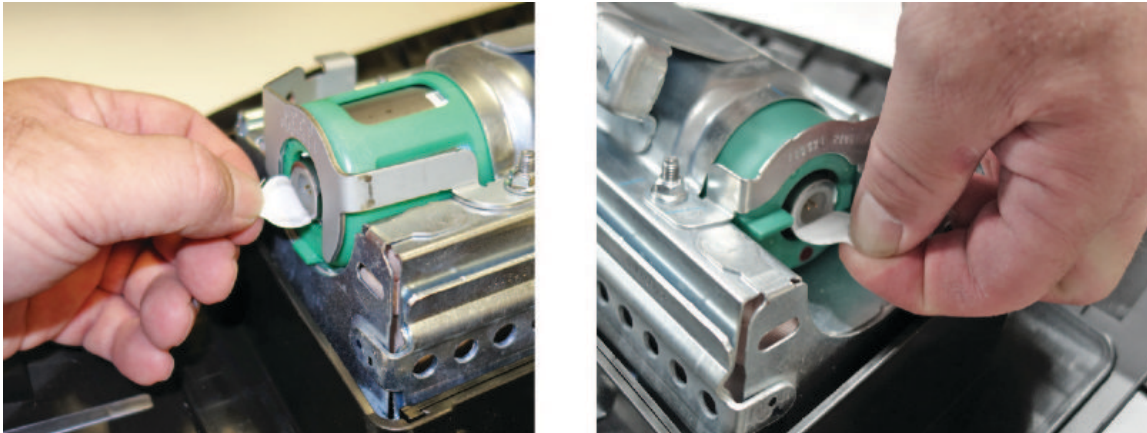

15. Using the V-SMART tool, validate that the airbag replacement inflator is installed correctly.

NOTES

- You must validate the front passenger's airbag replacement inflator installation using the V-SMART tool **before** connecting the inflator harness.
- Your warranty claim will not be paid if the V-SMART validation is not completed or the photo is not sent. Make sure you see the **Uploaded Completed** message to confirm the photo was sent to the warranty department.

16. Install the new inflator harness.

16.1. Make sure the airbag and harness are aligned as shown.

NOTES

- **The replacement inflator harnesses have the wire colors in the opposite positions of the original harness.** If you connect the harness incorrectly, the harness cannot be removed and you will not be able to reinstall the airbag because the harness will be too short.
- Connect the red wire connector to the short collar side of the inflator with the red dot.
- Connect the yellow wire connector to the long collar side of the inflator.

ORIGINAL INFLATOR HARNESS ROUTING

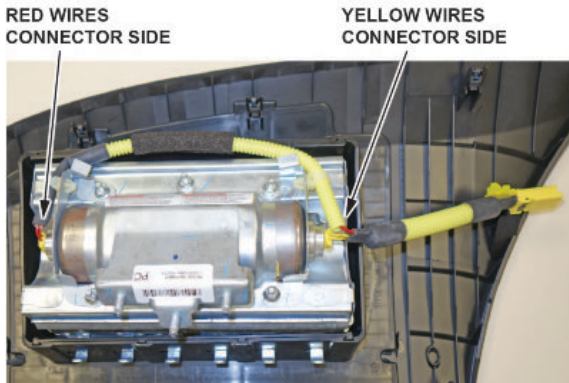

NEW INFLATOR HARNESS ROUTING

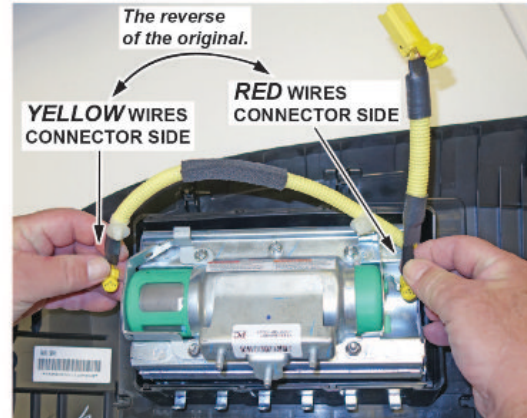

16.2. Connect the two connectors. Align the "T" shape in the inflator harness connector with the T-shaped inflator connector, then press the connector into place.

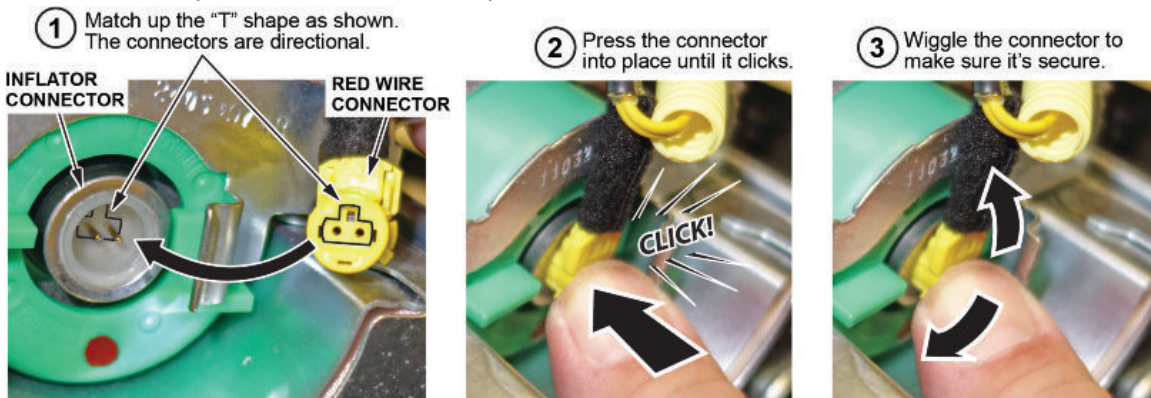

16.3. After you hear each connector click, wiggle it to make sure it is secure.

NOTE

If the connector is not properly aligned, it will come out.

17. Connect the harness to the inflator brackets as shown.

Reconnect the harness clips.

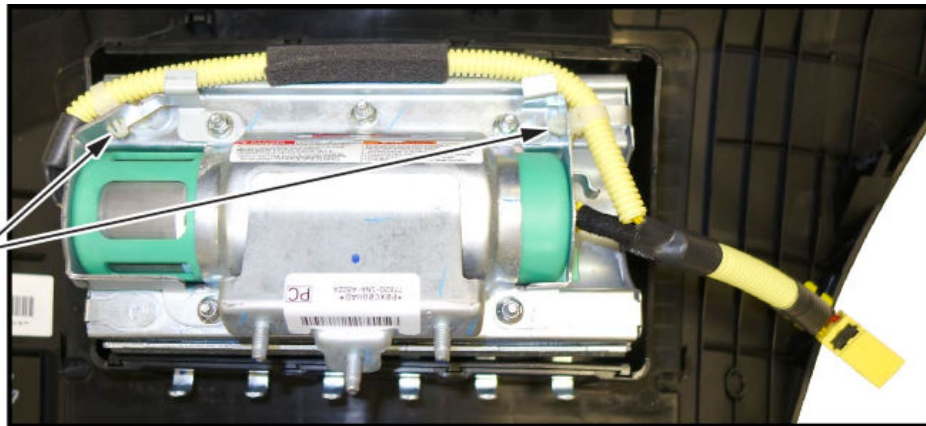

18. Reinstall the passenger's airbag into the vehicle and torque the new locknuts to **9.8 N•m (7.2 lb-ft)** .
19. Reconnect the battery negative cable and enter the anti-theft code for the audio and navigation system (if applicable), then enter the audio presets.
20. Set the clock (for vehicles without navigation).
21. Turn the ignition to ON and make sure the SRS indicator comes on for about 6 seconds, then goes off.
22. Put the original inflator into the box the new one came in. Make sure there is no other hardware in the box because if the package rattles, it will not be accepted by the courier.
23. Follow the shipping instructions outlined in PIB A15-0002 to return the undeployed inflator.
24. Give your warranty clerk the RO that includes the replacement inflator serial number and replacement part number. For the warranty claim to be paid, the **replacement inflator part number** must be included in the warranty claim.

NOTES

- **If the VIN status inquiry indicates that the vehicle is subject to any open safety recalls, including the driver's airbag inflator, make sure to also complete those recall repairs before returning the vehicle to the customer. If you are unable to complete any open recall, advise the customer of the recall status and when the recall could be completed.**
 - Make sure you have the anti-theft code for the audio and navigation system (if applicable), then write down the frequencies for the radio's preset buttons.
 - Be careful not to damage any parts when replacing the inflator, and **follow the procedure exactly**.
 - If, before removing the airbag, you suspect that it may be the incorrect airbag for the vehicle or a counterfeit, **do not remove the airbag**. Contact your DPSM for assistance.
 - Make sure you have reviewed the SRS Precautions and Procedures in the service information before doing the REPAIR PROCEDURE.
1. Turn the ignition switch to the ON (II) position and check if the SRS indicator comes on for about 6 seconds, then turns off.
 - If the indicator comes on, then turns off after about 6 seconds, go to step 2.
 - If the indicator does not come on, or if it stays on, contact your DPSM for assistance.
 2. Disconnect the battery negative cable and wait at least 3 minutes before continuing.
 3. Remove the front passenger's airbag by referring to the service information.
 4. Place the airbag, face-down, on a clean shop towel.

NOTE

The orientation of the airbag is critical because if the inflator is installed incorrectly, the harness will be too short when you reinstall the airbag.

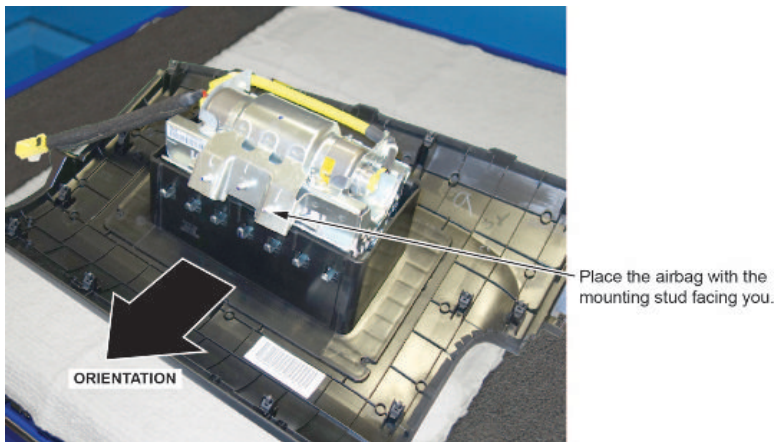

5. Visually inspect the airbag and the inflator for any unusual writing or markings. Refer to IDENTIFYING COUNTERFEIT AIRBAGS.

6. Peel the label located inside the inflator box from its backing and attach it to the RO. For the warranty claim to be paid, the **replacement inflator part number that you received** must be included in the warranty claim.

NOTES

- The replacement part number is printed on the top part of the label and the serial number is printed on the bottom. **Make sure you attach the label to the RO and give it to the warranty clerk .**
- There may also be a colored sticker located in the kit, ignore it because it is not used.
- Not all inflator kits have a label included. In those cases, write the serial number and part number from the side of the inflator box on the RO. The part number always starts with 047.

PASSENGER INFLATOR PARTS BOX

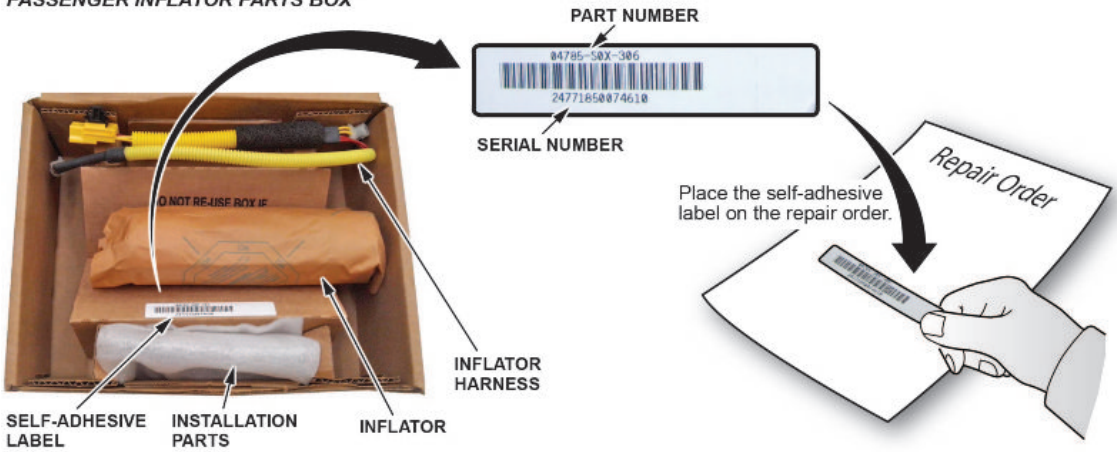

7. Remove the harness from the inflator bracket.

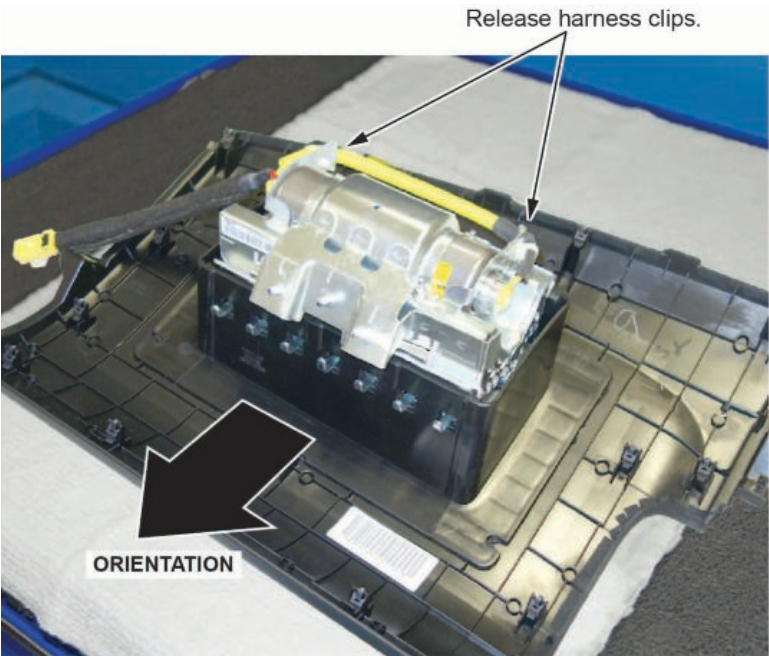

8. Short the yellow wires.

NOTES

- **You must cut the yellow wires** for inflator removal and short the yellow wires on the inflator side as indicated to prevent accidental deployment.
- **Do not cut the red wires** because the airbag connector shorts these inflator wires.

8.1. Cut the yellow wires as shown.

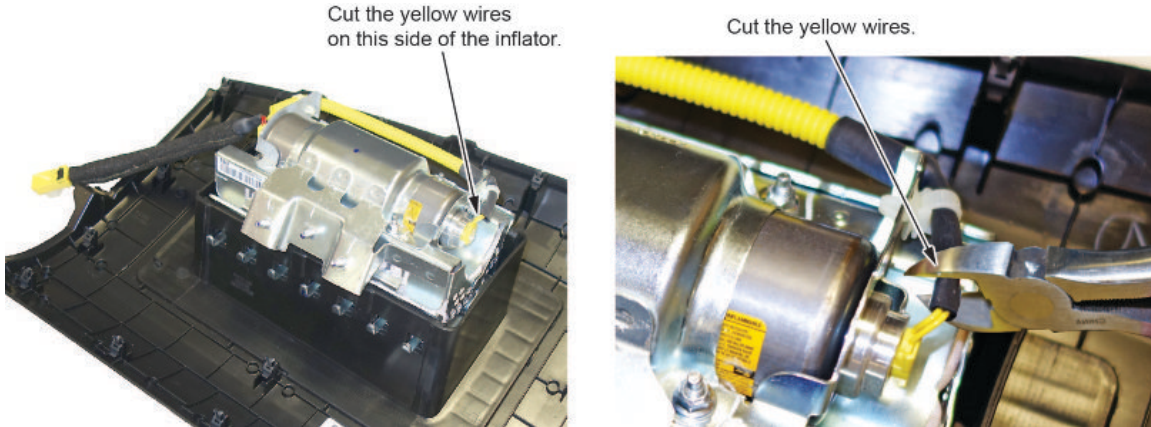

8.2. Strip away about 1 inch of the yellow wire insulation, then twist the wires together.

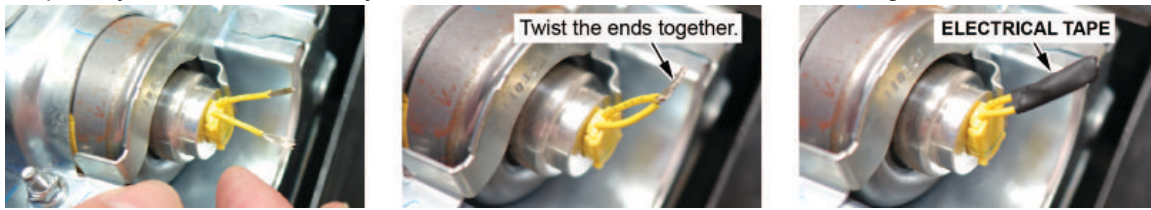

8.3. Tape the twisted ends with electrical tape.

9. Remove the four inflator nuts.

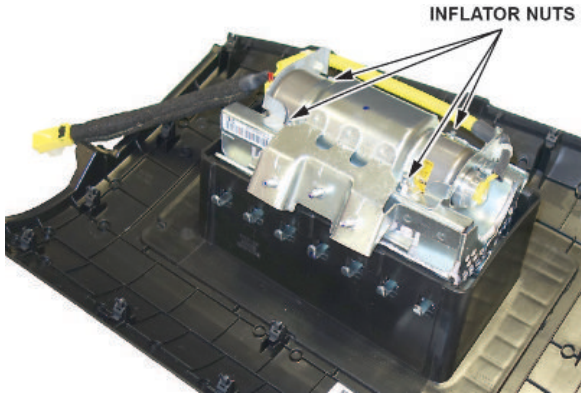

10. Remove the inflator bracket.

NOTES

- You can only remove one of the brackets, as the other is welded to the airbag housing.
- Do not reuse the bracket; use the new one that came in the inflator kit.

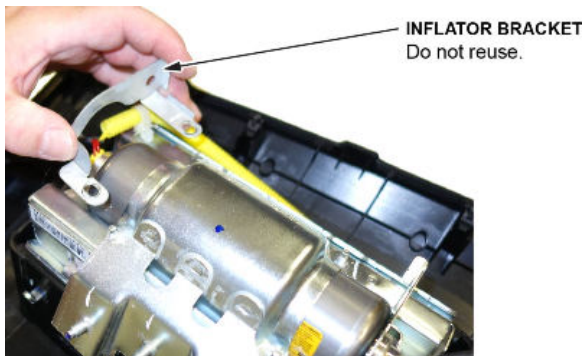

11. Remove the inflator by pulling it out.



12. Install the new inflator.

NOTE

There may be some minor surface rust or corrosion on the new inflator; this is OK.

P/N 04790-SWA-407 or 04790-SWA-A00

12.1. One side of the inflator has a longer collar, a single tab, a plastic cutout, and a small flat spot on the connector. The other side of the inflator has a shorter collar, two tabs, and a red dot. **Make sure you insert the end with the shorter collar into the airbag first.**

NOTES

- The V-SMART tool can only validate inflators with slotted end caps. You may receive an inflator with solid end caps. This is the correct part to repair the vehicle, but the V-SMART will fail the validation. **The V-SMART validation must fail a total of three times** before you can have your supervisor override the validation using the **Supervisor Inspection Override**.
- Your supervisor can be a service manager, shop foreman, team leader, etc. **The supervisor must inspect your work** to make sure the replacement inflator was installed correctly. When a supervisor enters his or her information, **the supervisor is signing off that the technician's work was inspected and approved.**

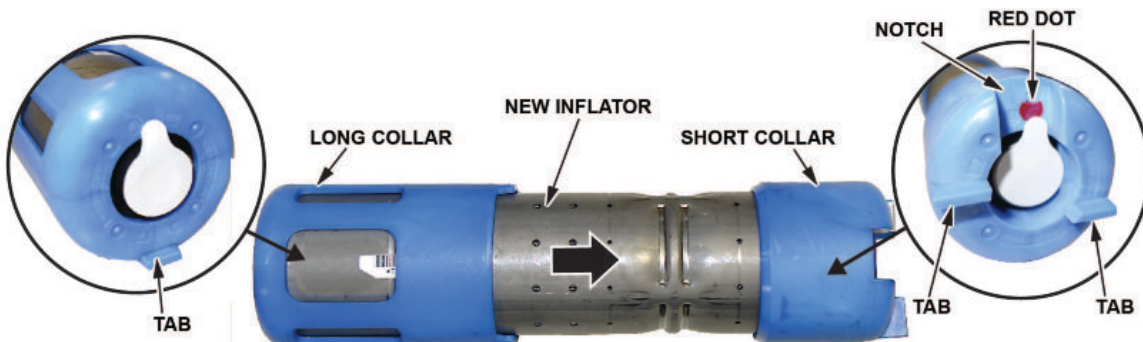

LONG COLLAR The inflator installation is directional.



12.2. Slide the inflator in until the plastic collar contacts the bracket. The two tabs should align with the side of the airbag module and the metal tab as shown. There should be no space or gap between the inflator and bracket. There is a red dot located on the fixed bracket side, which may be difficult to see because of the bracket.

FIXED BRACKET END

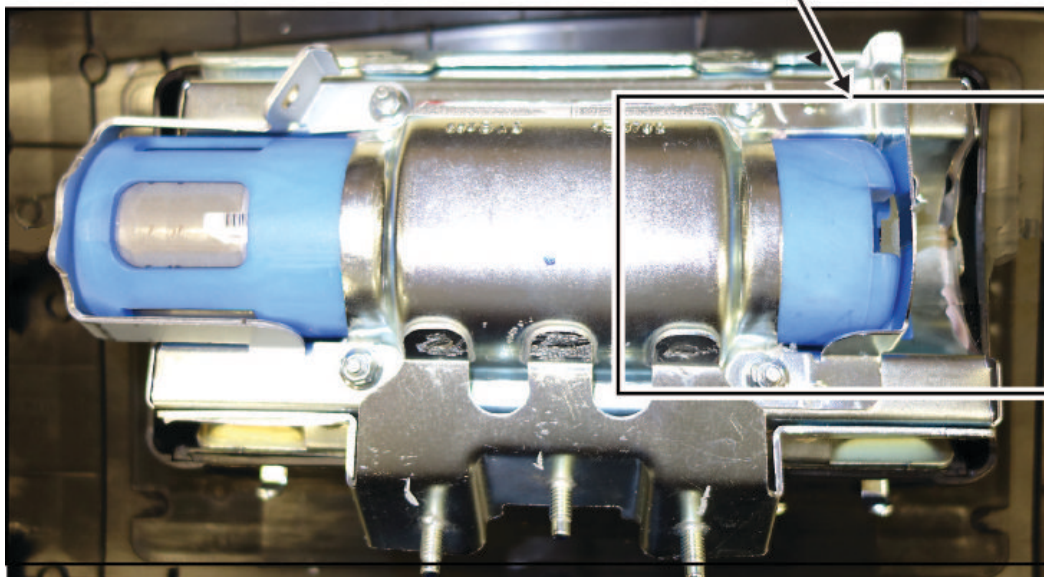
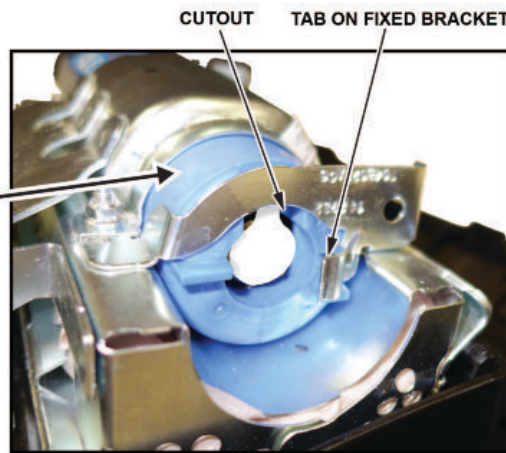
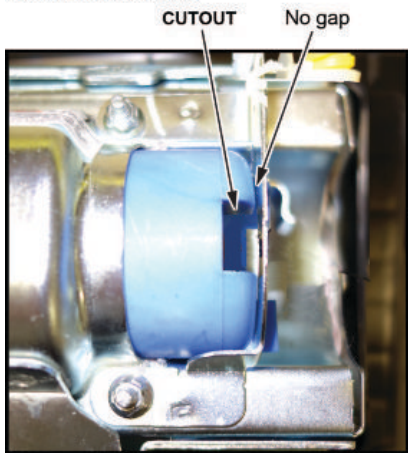

12.3. Install the bracket included in the kit onto the airbag module. Check there is no space or gap between the inflator and bracket by pushing the bracket against the inflator.

NOTE

The bracket may have a little bit of play before you install the new nuts.

ADJUSTABLE BRACKET END

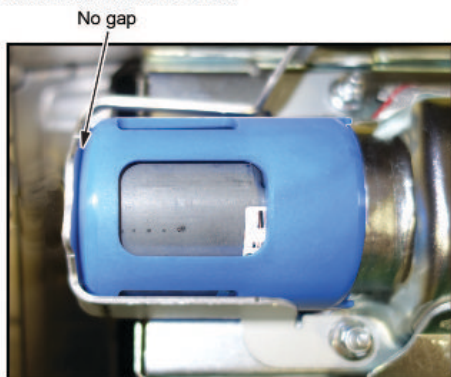

ADJUSTABLE BRACKET

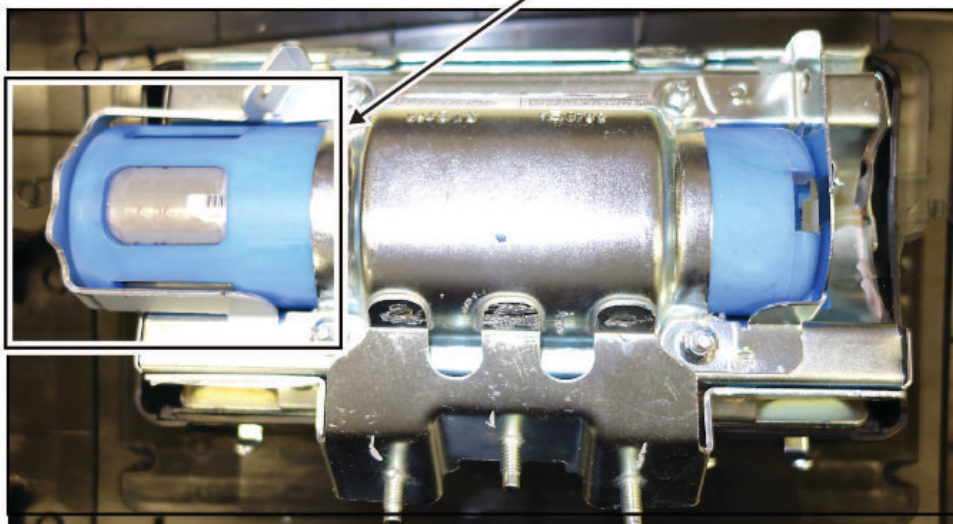
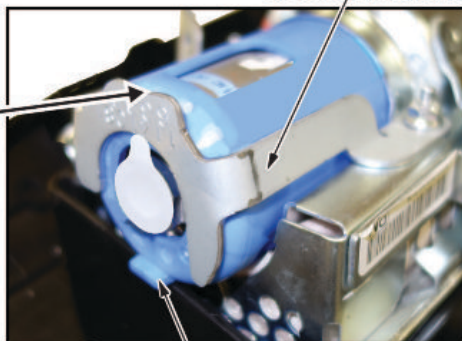

13. Hold the bracket against the inflator, then install the four new 5 mm locknuts and torque them in sequence to **3.9 N•m (34 lb-in)**.

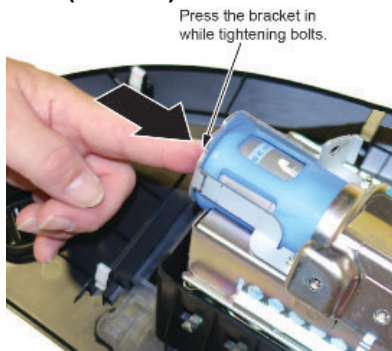

Press the bracket in while tightening bolts.

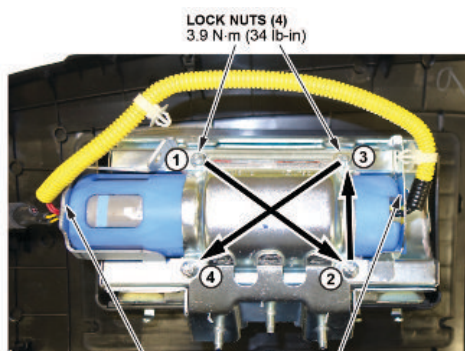

LOCK NUTS (4)
3.9 N•m (34 lb-in)

Be sure there are no gaps between the inflator ends and the inflator brackets.

14. Remove the stickers covering the terminals on both sides of the new inflator.

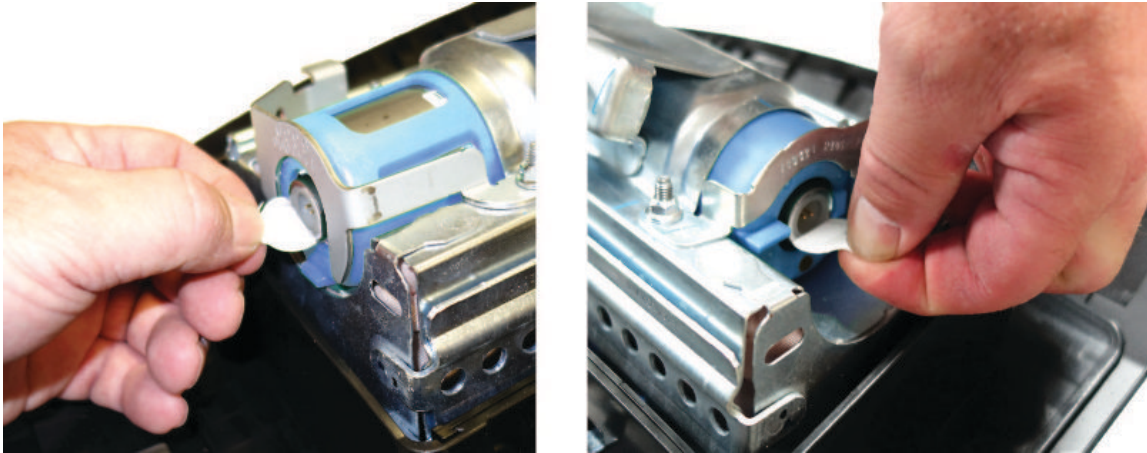

15. Using the V-SMART tool, validate that the airbag replacement inflator is installed correctly.

NOTES

- You must validate the front passenger's airbag replacement inflator installation using the V-SMART tool **before** connecting the inflator harness.
- Your warranty claim will not be paid if the V-SMART validation is not completed or the photo is not sent. Make sure you see the **Uploaded Completed** message to confirm the photo was sent to the warranty department.

16. Install the new inflator harness.

16.1. Make sure the airbag and harness are aligned as shown.

NOTES

- **The replacement inflator harnesses have the wire colors in the opposite positions of the original harness.** If you connect the harness incorrectly, the harness cannot be removed and you will not be able to reinstall the airbag because the harness will be too short.
- Connect the red wire connector to the short collar side of the inflator with the red dot.
- Connect the yellow wire connector to the long collar side of the inflator.
- The red dot may be difficult to see because of the bracket.

ORIGINAL INFLATOR HARNESS ROUTING

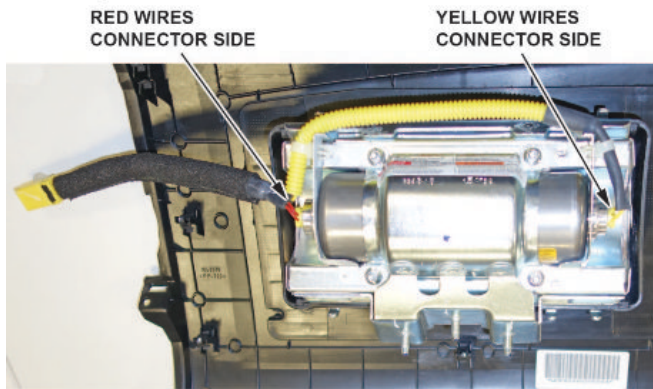

NEW INFLATOR HARNESS ROUTING

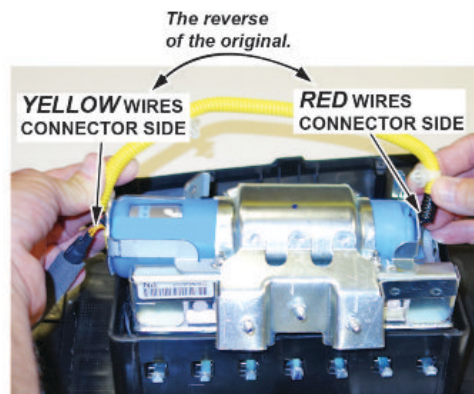

16.2. Connect the red wire connector to the connector on the side with the short plastic collar. Align the “T” shape in the inflator harness connector with the T-shaped inflator connector, then press the connector into place.

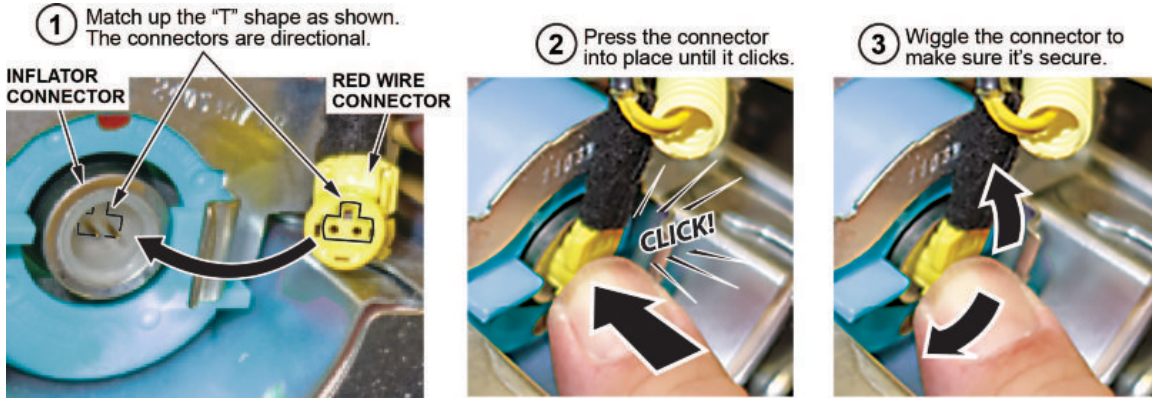

16.3. Connect the yellow wire connector to the connector on the side with the long plastic collar.

16.4. After you hear each connector click, wiggle it to make sure it is secure.

NOTE

If the connector is not properly aligned, it will come out.

16.5. Make sure the connector is secure and in place by using the gauge tool. (PSP16 Gauge Tool P/N: 070AJ-TA00A00 or 07AAJ-TA0AA00).

Be sure the connector is fully seated by checking it with the gauge tool.

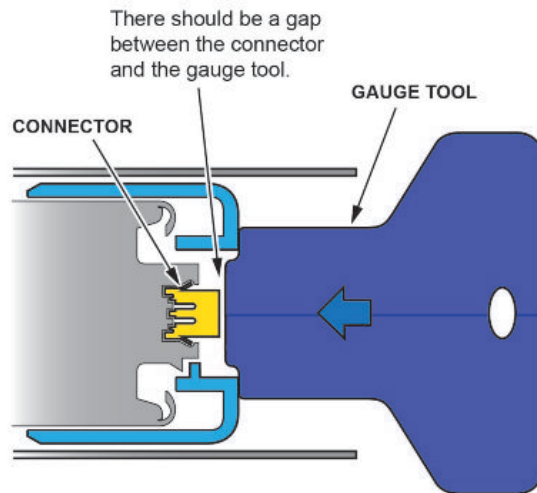
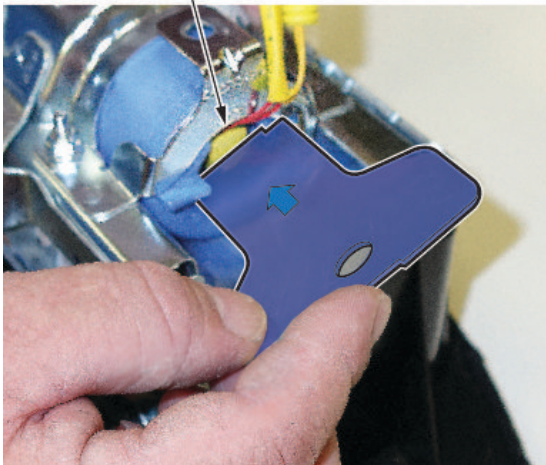

17. Connect the harness to the inflator brackets.

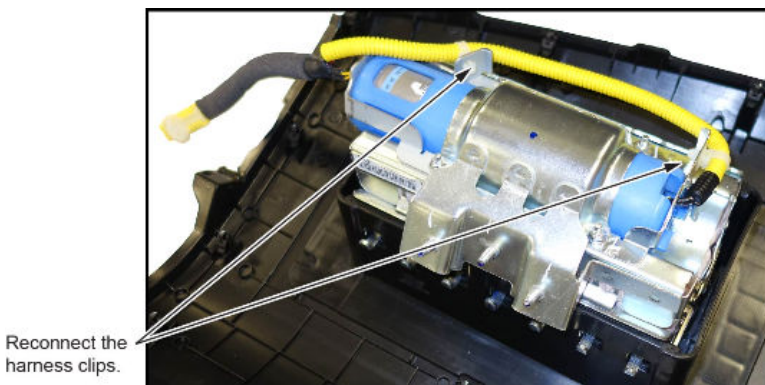

18. Reconnect the battery negative cable and enter the anti-theft code for the audio and navigation system (if applicable), then enter the audio presets.

19. Set the clock (for vehicles without navigation).
20. Turn the ignition to ON and make sure the SRS indicator comes on for about 6 seconds, then goes off.
21. Put the original inflator into the box the new one came in. Make sure there is no other hardware in the box because if the package rattles, it will not be accepted by the courier.
22. Follow the shipping instructions outlined in PIB A15-0002 to return the undeployed inflator.
23. Give your warranty clerk the RO that includes the replacement inflator serial number and replacement part number. For the warranty claim to be paid, the **replacement inflator part number** must be included in the warranty claim.

NOTES

- If the VIN status inquiry indicates that the vehicle is subject to any open safety recalls, including the driver's airbag inflator, make sure to also complete those recall repairs before returning the vehicle to the customer. If you are unable to complete any open recall, advise the customer of the recall status and when the recall could be completed.
 - Make sure you have the anti-theft code for the audio and navigation system (if applicable), then write down the frequencies for the radio's preset buttons.
 - Be careful not to damage any parts when replacing the inflator, and **follow the procedure exactly**.
 - If, before removing the airbag, you suspect that it may be the incorrect airbag for the vehicle or a counterfeit, **do not remove the airbag**. Contact your DPSM for assistance.
 - Make sure you have reviewed the SRS Precautions and Procedures in the service information before doing the REPAIR PROCEDURE.
1. Turn the ignition switch to the ON (II) position and check if the SRS indicator comes on for about 6 seconds, then turns off.
 - If the indicator comes on, then turns off after about 6 seconds, go to step 2.
 - If the indicator does not come on, or if it stays on, contact your DPSM for assistance.
 2. Disconnect the battery negative cable and wait at least 3 minutes before continuing.
 3. Remove the front passenger's airbag by referring to the service information.
 4. Place the airbag, face-down, on a clean shop towel.

NOTES

- The orientation of the airbag is critical because if the inflator is installed incorrectly, the harness will be too short when you reinstall the airbag.
- The Fit does not have mounting studs. It is secured in the vehicle with bolts, so make sure the mounting bolt holes are facing you.

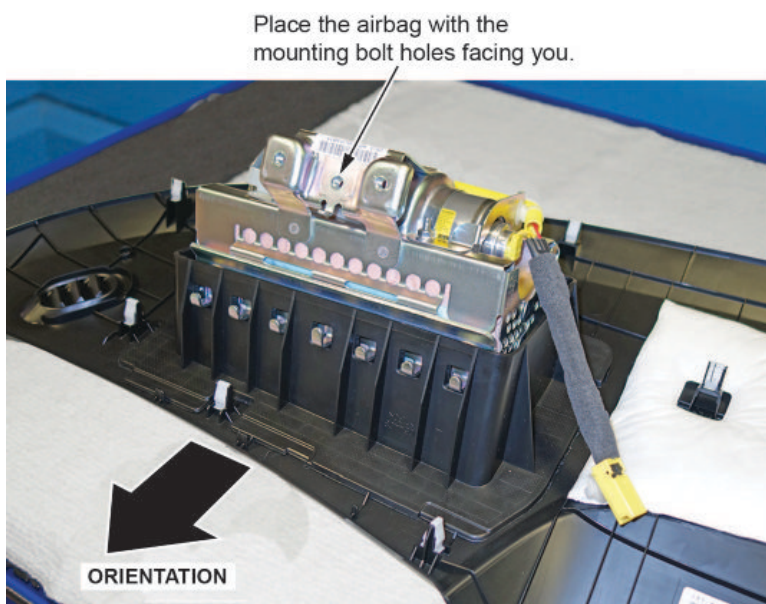

5. Visually inspect the airbag and the inflator for any unusual writing or markings. Refer to IDENTIFYING COUNTERFEIT AIRBAGS.

6. Peel the label located inside the inflator box from its backing and attach it to the RO. For the warranty claim to be paid, the **replacement inflator part number that you received** must be included in the warranty claim.

NOTES

- The replacement part number is printed on the top part of the label and the serial number is printed on the bottom. **Make sure you attach the label to the RO and give it to the warranty clerk .**
- There may also be a colored sticker located in the kit, ignore it because it is not used.
- Not all inflator kits have a label included. In those cases, write the serial number and part number from the side of the inflator box on the RO. The part number always starts with 047.

PASSENGER INFLATOR PARTS BOX

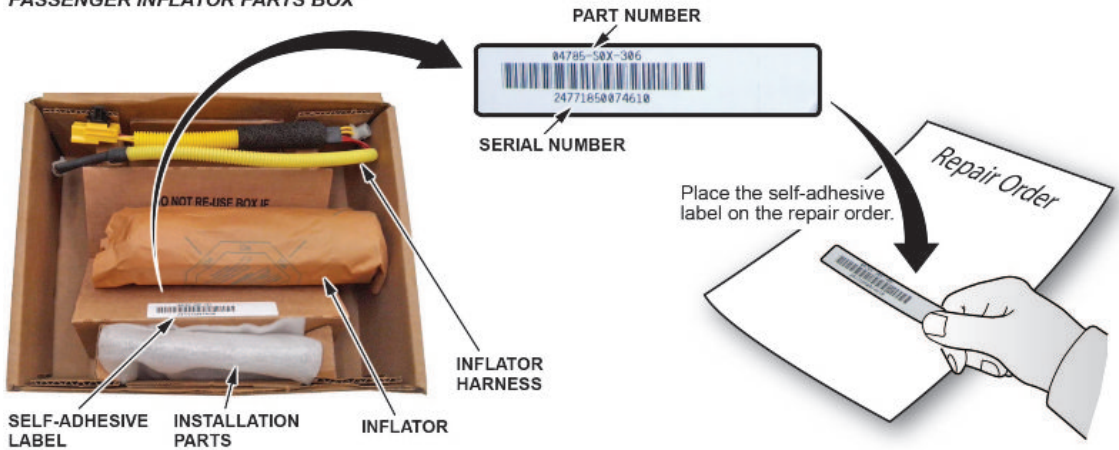

7. Remove the harness from the inflator bracket.
Release harness clips.

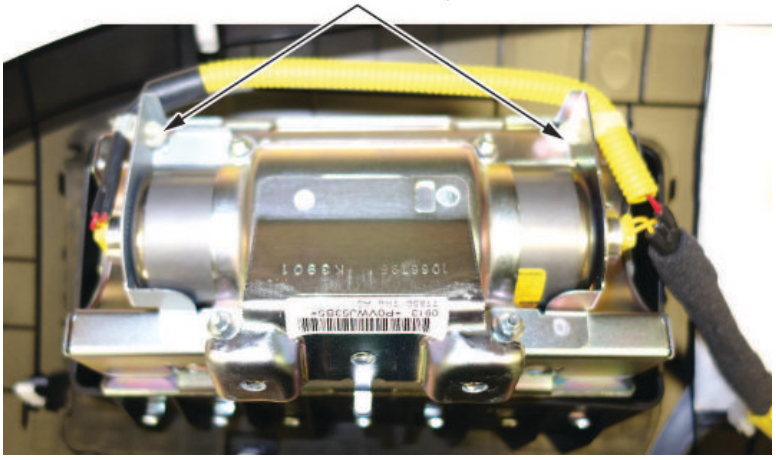

8. Short the yellow wires.

NOTES

- **You must cut the yellow wires** for inflator removal and short the yellow wires on the inflator side as indicated to prevent accidental deployment.
- **Do not cut the red wires** because the airbag connector shorts these inflator wires.
- There is glue securing the black insulation to the yellow wires. Be careful not to cut the wires when removing the insulation.

8.1. Cut 1–2 inches of the corrugated tube to access the yellow wires.

8.2. Cut the yellow wires as shown.

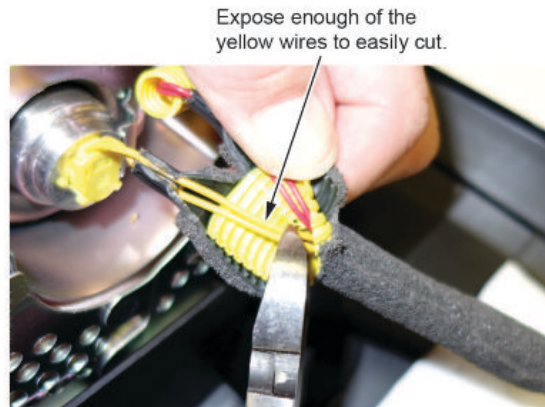

8.3. Strip away about 1 inch of the yellow wire insulation, then twist the wires together.

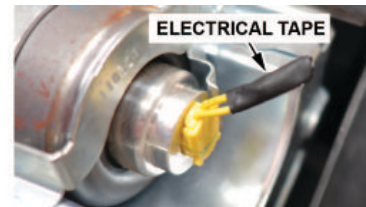
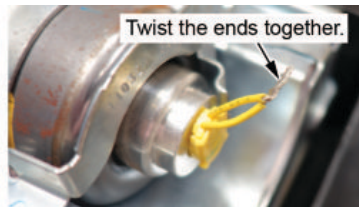

8.4. Tape the twisted ends with electrical tape.

9. Remove the four inflator nuts.

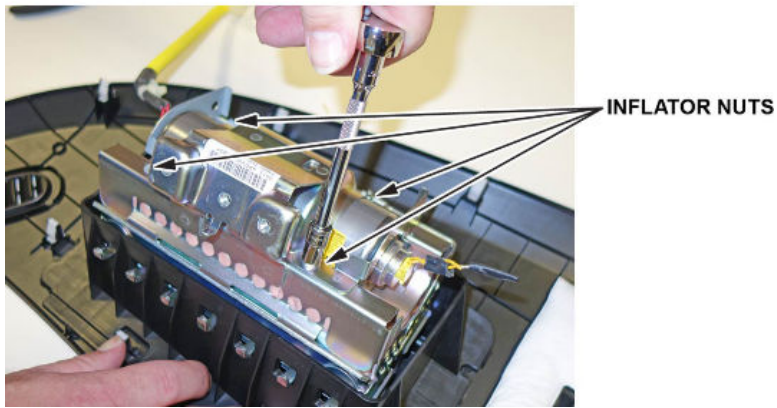

10. Remove the inflator bracket.

NOTES

- You can only remove one of the brackets, as the other is welded to the airbag housing.
- Do not reuse the bracket; use the new one that came in the inflator kit.

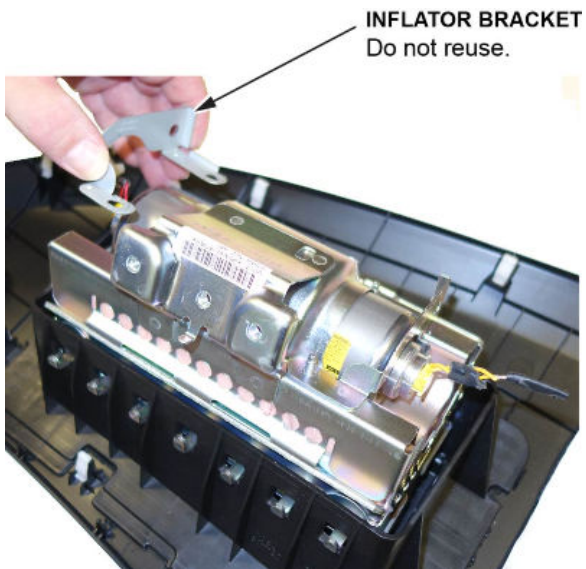

11. Remove the inflator by pulling it out.



12. Install the new inflator.

NOTE

There may be some minor surface rust or corrosion on the new inflator; this is OK.

P/N 04790-TK6-407 or 04790-TK6-A00

12.1. One side of the inflator has a longer collar, a single tab, a plastic cutout, and a small flat spot on the connector. The other side of the inflator has a shorter collar, two tabs, and a red dot. **Make sure you insert the end with the shorter collar into the airbag first.**

NOTES

- The V-SMART tool can only validate inflators with slotted end caps. You may receive an inflator with solid end caps. This is the correct part to repair the vehicle, but the V-SMART will fail the validation. **The V-SMART validation must fail a total of three times** before you can have your supervisor override the validation using the **Supervisor Inspection Override**.
- Your supervisor can be a service manager, shop foreman, team leader, etc. **The supervisor must inspect your work** to make sure the replacement inflator was installed correctly. When a supervisor enters his or her information, **the supervisor is signing off that the technician's work was inspected and approved.**

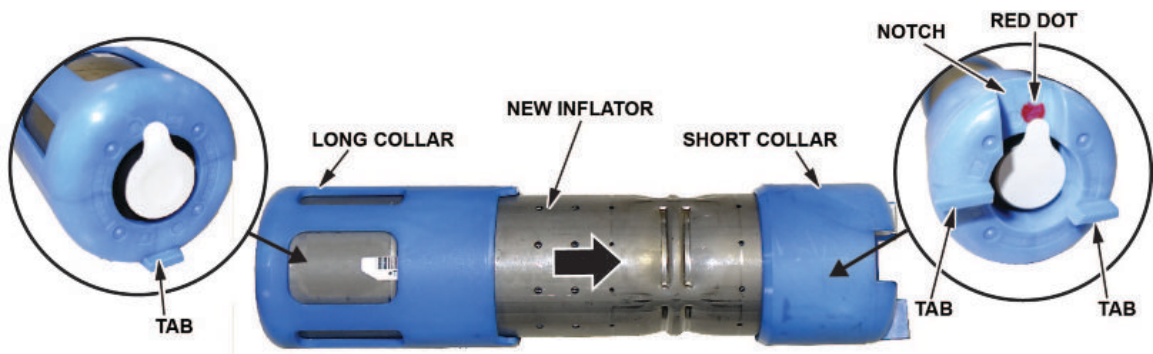

12.2. Slide the inflator in until the plastic collar contacts the bracket. The two tabs should align with the side of the airbag module and the metal tab as shown. There should be no space or gap between the inflator and bracket.

FIXED BRACKET END

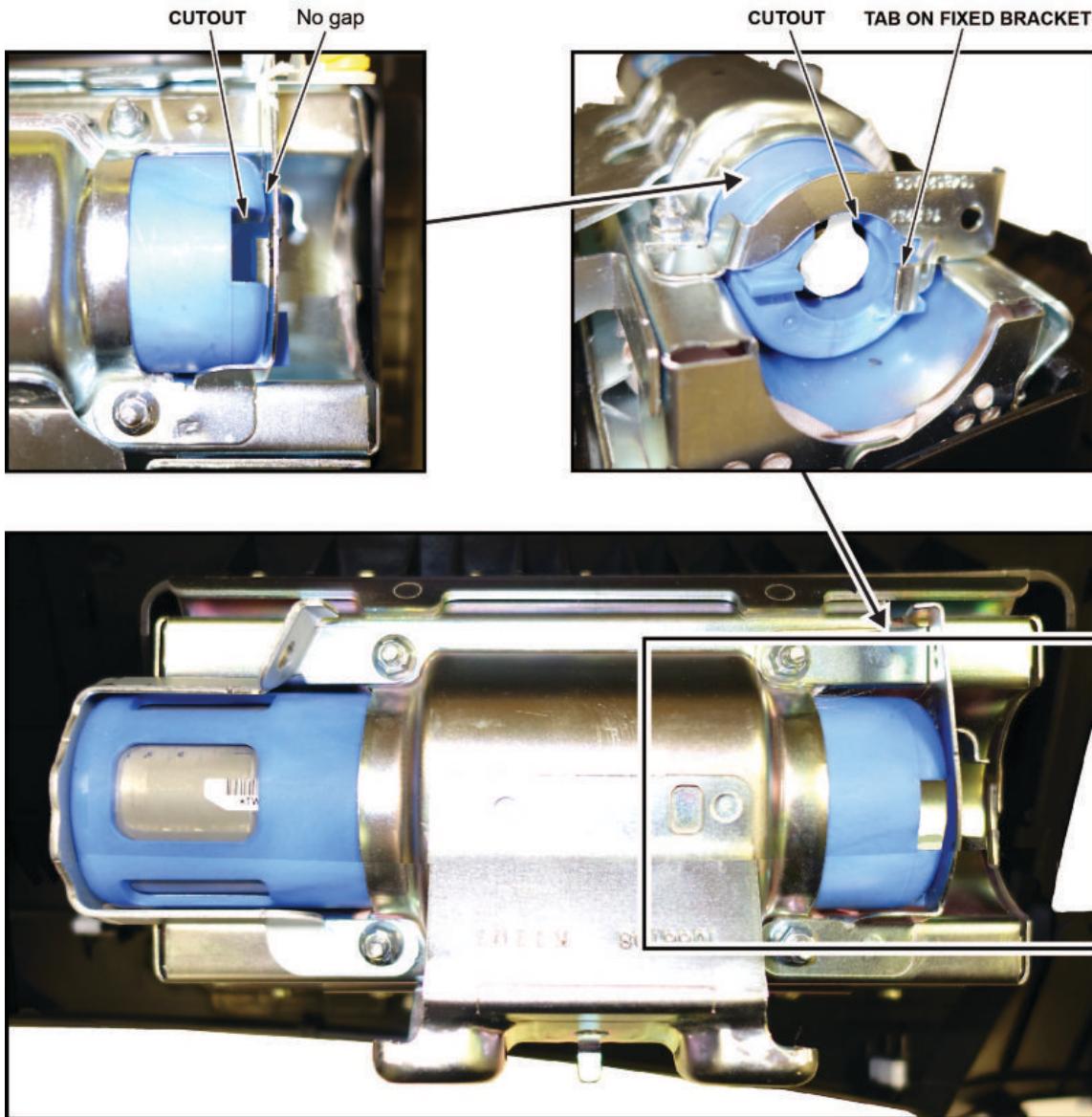

12.3. Install the bracket included in the kit onto the airbag module. Check there is no space or gap between the inflator and bracket by pushing the bracket against the inflator.

NOTE

The bracket may have a little bit of play before you install the new nuts.

ADJUSTABLE BRACKET END

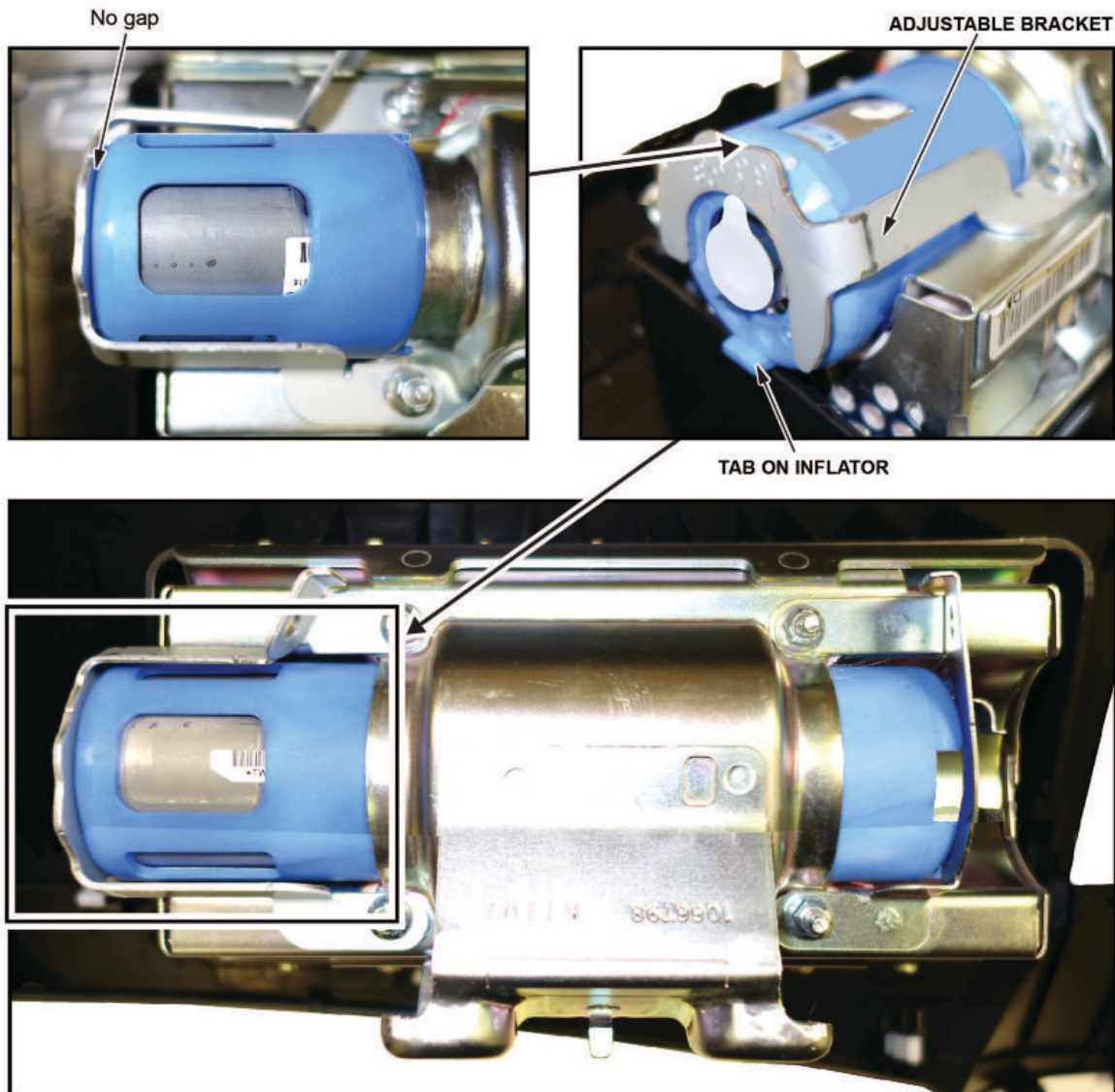

13. Hold the bracket against the inflator, then install the new 5 mm locknuts and torque them in sequence to **3.9 N•m (34 lb-in)**.

NOTE

Make sure you push the bracket against the inflator to ensure there are no gaps between the brackets and inflator when torquing the nuts.

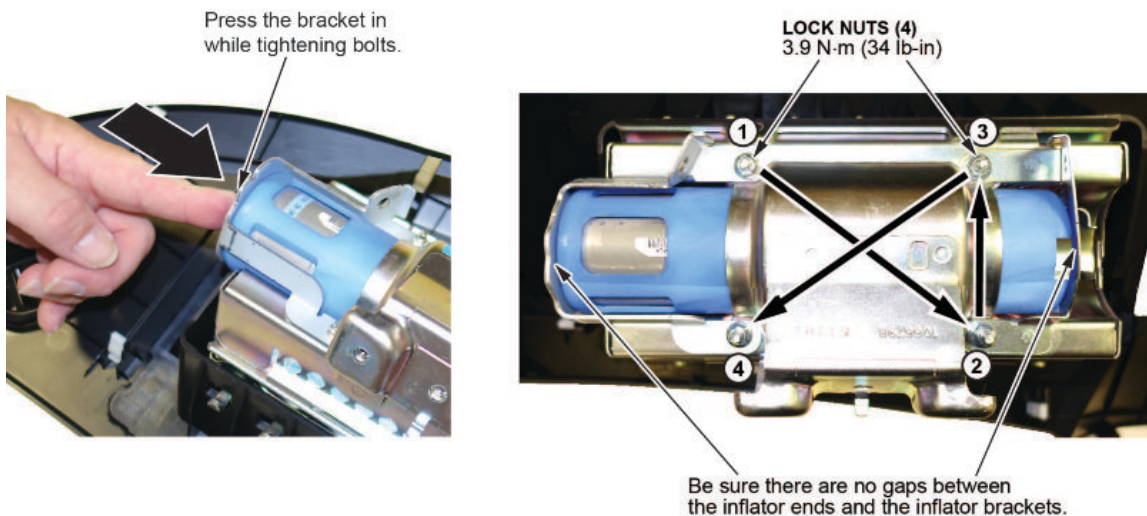

14. Remove the stickers covering the terminals on both sides of the new inflator.

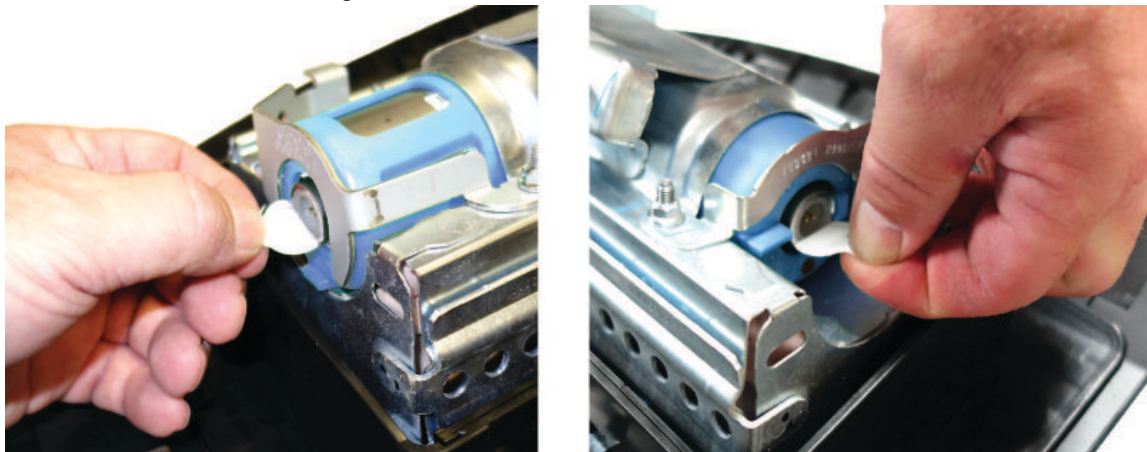

15. Using the V-SMART tool, validate that the airbag replacement inflator is installed correctly.

NOTES

- You must validate the front passenger's airbag replacement inflator installation using the V-SMART tool **before** connecting the inflator harness.
- Your warranty claim will not be paid if the V-SMART validation is not completed or the photo is not sent. Make sure you see the **Uploaded Completed** message to confirm the photo was sent to the warranty department.

16. Install the new inflator harness.

16.1. Make sure the airbag and harness are aligned as shown.

NOTES

- **The replacement inflator harnesses have the wire colors in the opposite positions of the original harness.** If you connect the harness incorrectly, the harness cannot be removed and you will not be able to reinstall the airbag because the harness will be too short.
- Connect the red wire connector to the short collar side of the inflator with the red dot.
- Connect the yellow wire connector to the long collar side of the inflator.
- The red dot may be difficult to see because of the bracket.

ORIGINAL INFLATOR HARNESS ROUTING

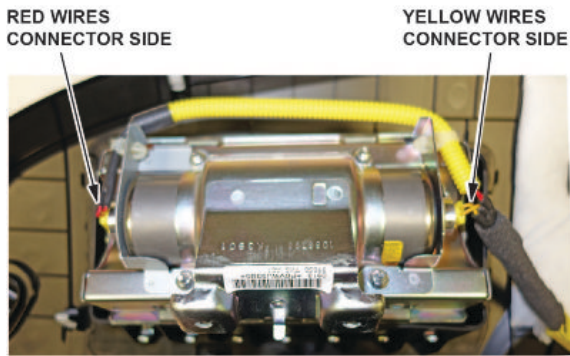

NEW INFLATOR HARNESS ROUTING

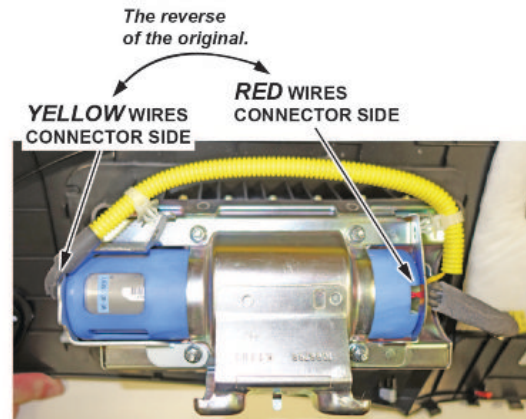

16.2. Connect the red wire connector to the connector on the side with the short plastic collar. Align the “T” shape in the inflator harness connector with the T-shaped inflator connector, then press the connector into place.

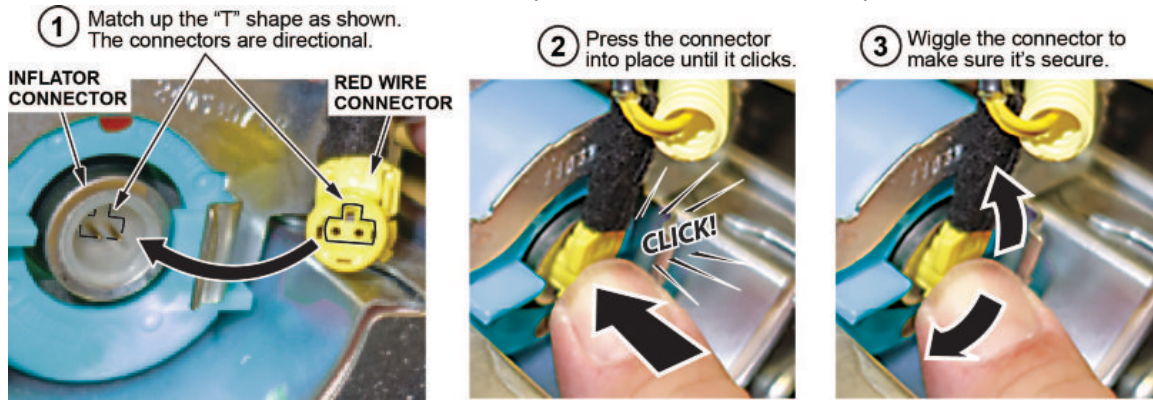

16.3. Connect the yellow wire connector to the connector on the side with the long plastic collar.

16.4. After you hear each connector click, wiggle it to make sure it is secure.

NOTE

If the connector is not properly aligned, it will come out.

16.5. Make sure the connector is secure and in place by using the gauge tool. (PSP16 Gauge Tool P/N: 070AJ-TA00A00 or 07AAJ-TA0AA00).

Be sure the connector is fully seated by checking it with the gauge tool.

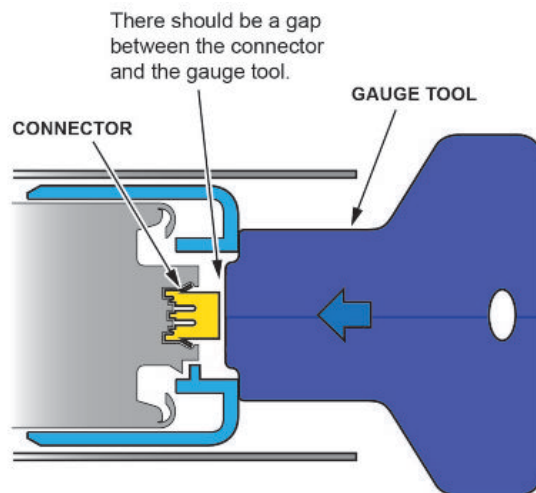
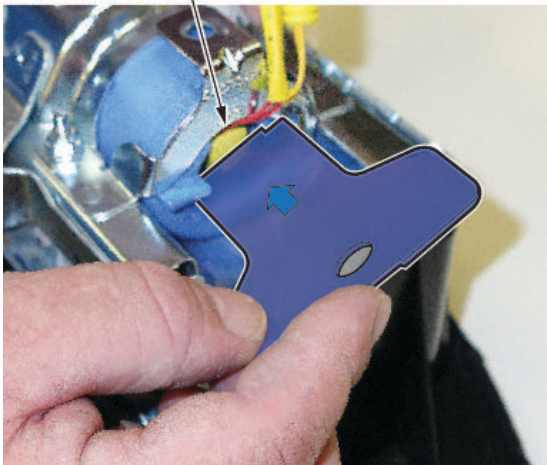

17. Connect the harness to the inflator brackets.

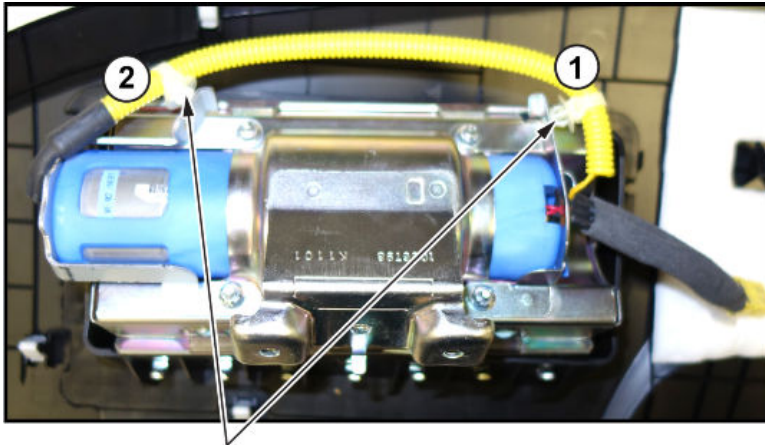

Reconnect the harness clips.

18. Reinstall the passenger's airbag into the vehicle and torque the new bolts to **9.8 N•m (7.2 lb-ft)**.
19. Reconnect the battery negative cable and enter the anti-theft code for the audio and navigation system (if applicable), then enter the audio presets.
20. Set the clock (for vehicles without navigation).
21. Turn the ignition to ON and make sure the SRS indicator comes on for about 6 seconds, then goes off.
22. Put the original inflator into the box the new one came in. Make sure there is no other hardware in the box because if the package rattles, it will not be accepted by the courier.
23. Follow the shipping instructions outlined in PIB A15-0002 to return the undeployed inflator.
24. Give your warranty clerk the RO that includes the replacement inflator serial number and replacement part number. For the warranty claim to be paid, the **replacement inflator part number** must be included in the warranty claim.

REPAIR PROCEDURE INSIGHT

NOTES

- **If the VIN status inquiry indicates that the vehicle is subject to any open safety recalls, including the driver's airbag inflator, make sure to also complete those recall repairs before returning the vehicle to the customer. If you are unable to complete any open recall, advise the customer of the recall status and when the recall could be completed.**
 - Make sure you have the anti-theft code for the audio and navigation system (if applicable), then write down the frequencies for the radio's preset buttons.
 - Be careful not to damage any parts when replacing the inflator, and **follow the procedure exactly**.
 - If, before removing the airbag, you suspect that it may be the incorrect airbag for the vehicle or a counterfeit, **do not remove the airbag**. Contact your DPSM for assistance.
 - Make sure you have reviewed the SRS Precautions and Procedures in the service information before doing the REPAIR PROCEDURE.
1. Turn the ignition switch to the ON (II) position and check if the SRS indicator comes on for about 6 seconds, then turns off.
 - If the indicator comes on, then turns off after about 6 seconds, go to step 2.
 - If the indicator does not come on, or if it stays on, contact your DPSM for assistance.
 2. Disconnect the battery negative cable and wait at least 3 minutes before continuing.
 3. Remove the front passenger's airbag.
 - 3.1. While holding the glove box, release the glove box stops on each side from the dashboard by pushing them in, then lower the glove box.
 - 3.2. Disconnect the dashboard wire harness 4P connector from the front passenger's airbag.
 - 3.3. Remove the two mounting nuts from the bracket.
 - 3.4. Remove the front passenger's airbag assembly from the dashboard.

NOTES

- The front passenger's lid has pawls on each side that attach it to the dashboard.
 - Take care not to scratch the dashboard or the front passenger's lid.
4. Place the airbag, face-down, on a clean shop towel.

NOTE

The orientation of the airbag is critical because if the inflator is installed incorrectly, the harness will be too short when you reinstall the airbag.

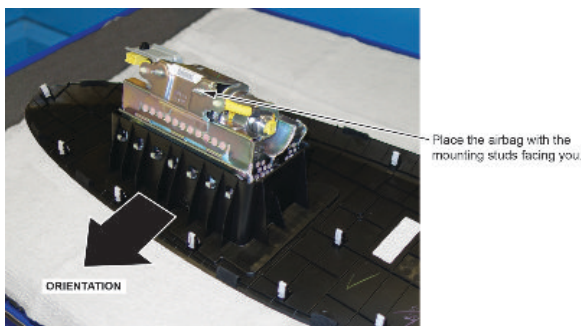

5. Visually inspect the airbag and the inflator for any unusual writing or markings. Refer to IDENTIFYING COUNTERFEIT AIRBAGS.

6. Peel the label located inside the inflator box from its backing and attach it to the RO. For the warranty claim to be paid, the **replacement inflator part number that you received** must be included in the warranty claim.

NOTES

- The replacement part number is printed on the top part of the label and the serial number is printed on the bottom. **Make sure you attach the label to the RO and give it to the warranty clerk .**
- There may also be a colored sticker located in the kit, ignore it because it is not used.
- Not all inflator kits have a label included. In those cases, write the serial number and part number from the side of the inflator box on the RO. The part number always starts with 047.

PASSENGER INFLATOR PARTS BOX

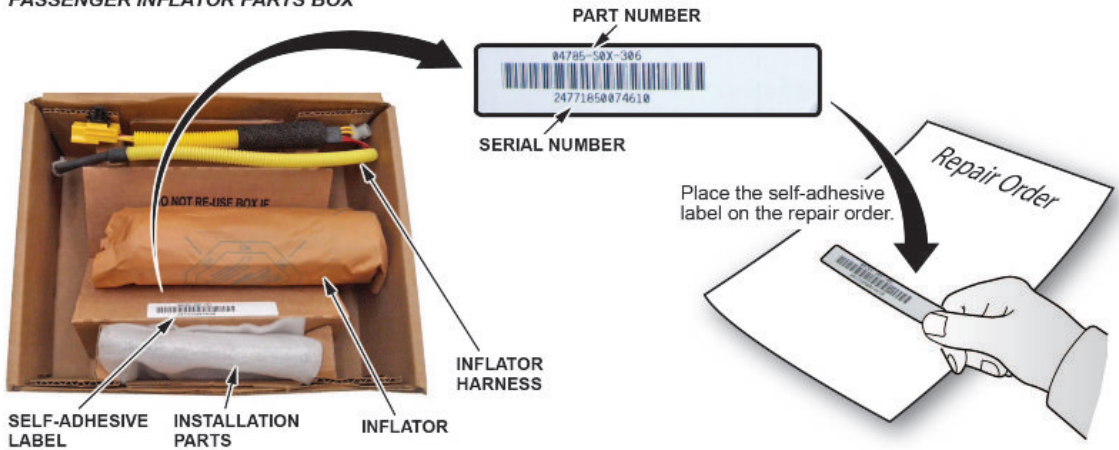

7. Remove the harness from the inflator bracket.
Release connector clip.

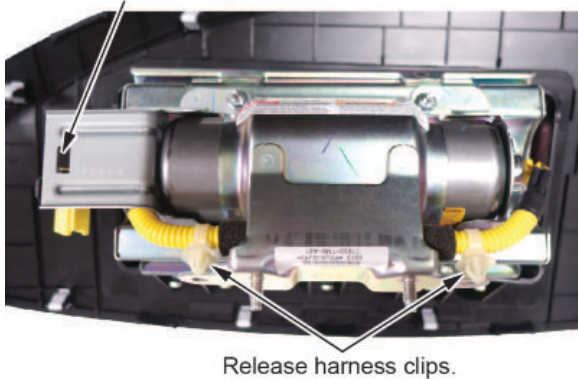

8. Short the yellow wires.

NOTES

- **You must cut the yellow wires** for inflator removal and short the yellow wires on the inflator side as indicated to prevent accidental deployment.
- **Do not cut the red wires** because the airbag connector shorts these inflator wires.

8.1. Cut the yellow wires next to the white harness clip as shown.

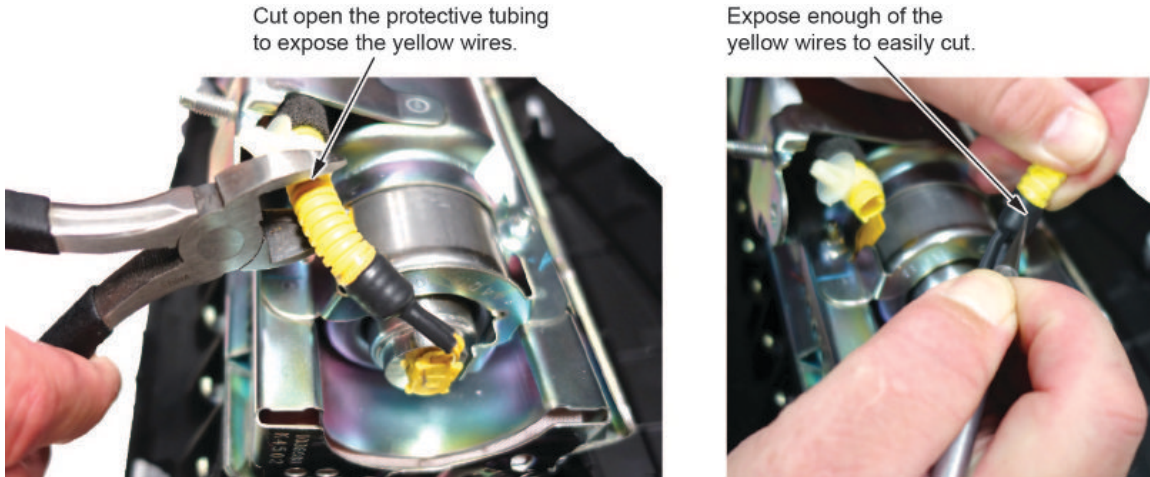

8.2. Strip away about 1 inch of the yellow wire insulation, then twist the wires together.

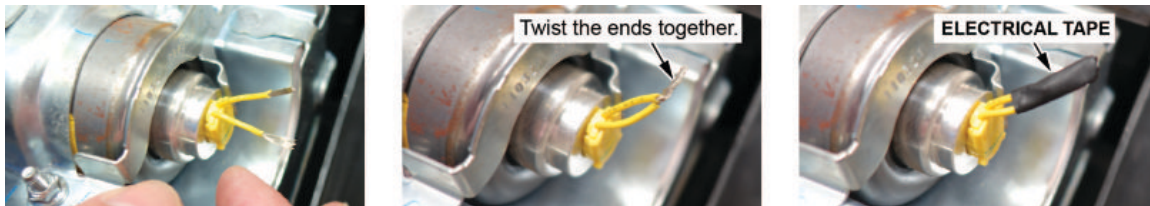

8.3. Tape the twisted ends with electrical tape.

9. Remove the four inflator nuts.

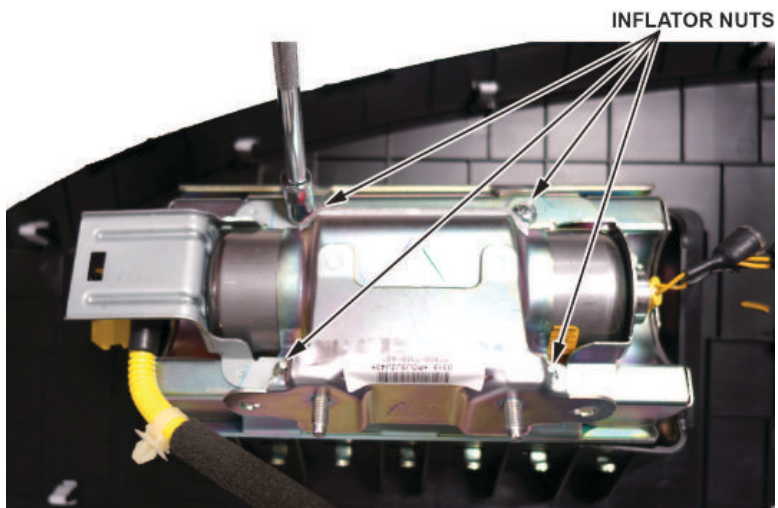

10. Remove the inflator bracket.

NOTES

- You can only remove one of the brackets, as the other is welded to the airbag housing.
- Do not reuse the bracket; use the new one that came in the inflator kit.

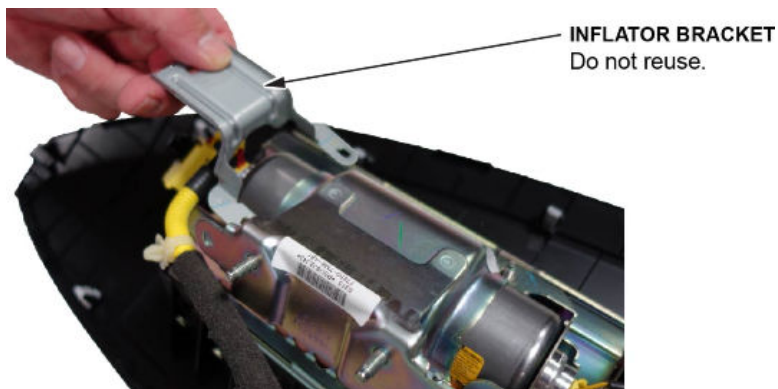

11. Remove the inflator by pulling it out.



12. Install the new inflator.

NOTE

There may be some minor surface rust or corrosion on the new inflator; this is OK.

P/N 04790-TM8-407 or 04790-TM8-A00

12.1. One side of the inflator has a longer collar, a single tab, a plastic cutout, and a small flat spot on the connector. The other side of the inflator has a shorter collar, two tabs, and a red dot. **Make sure you insert the end with the shorter collar into the airbag first.**

NOTES

- The V-SMART tool can only validate inflators with slotted end caps. You may receive an inflator with solid end caps. This is the correct part to repair the vehicle, but the V-SMART will fail the validation. **The V-SMART validation must fail a total of three times** before you can have your supervisor override the validation using the **Supervisor Inspection Override**.
- Your supervisor can be a service manager, shop foreman, team leader, etc. **The supervisor must inspect your work** to make sure the replacement inflator was installed correctly. When a supervisor enters his or her information, **the supervisor is signing off that the technician's work was inspected and approved.**

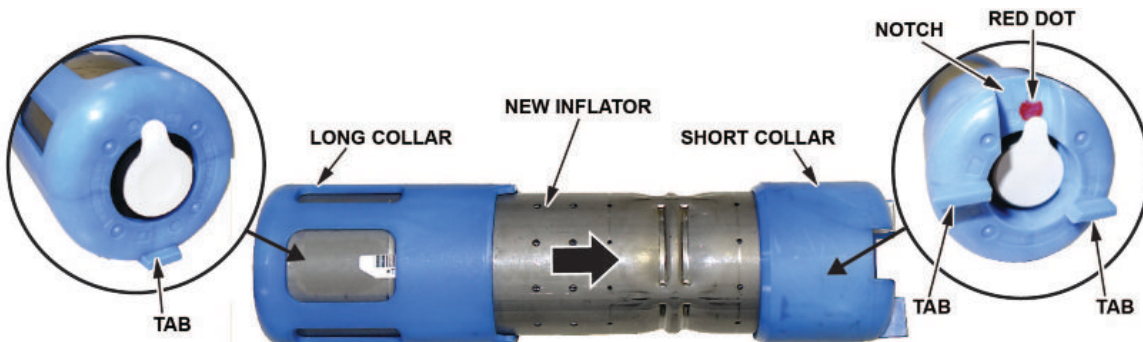

LONG COLLAR The inflator installation is directional.

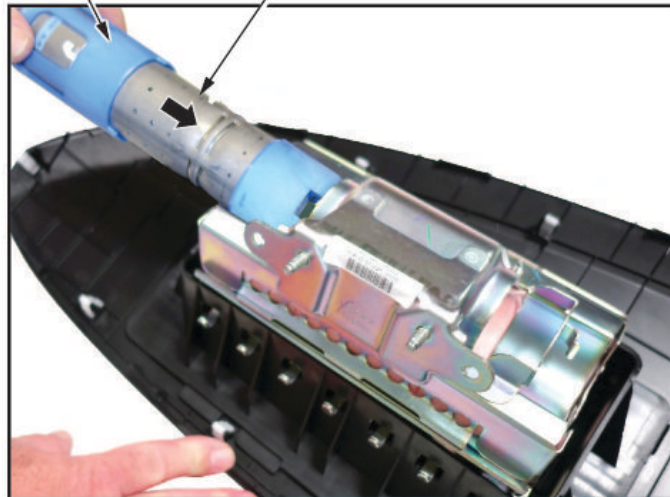

12.2. Slide the inflator in until the plastic collar contacts the bracket. The two tabs should align with the side of the airbag module and the metal tab as shown. There should be no space or gap between the inflator and bracket.

FIXED BRACKET END

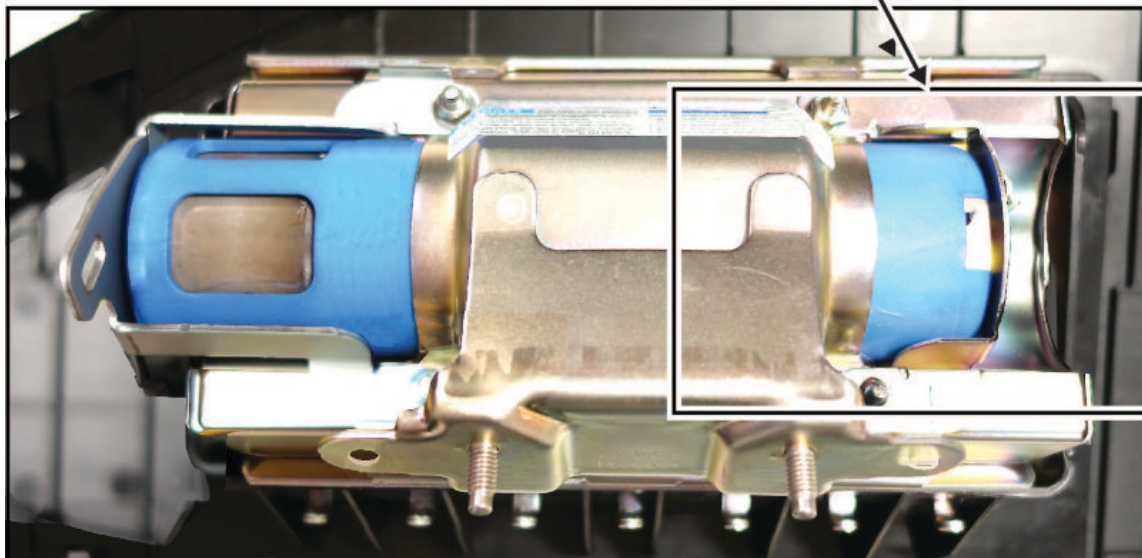
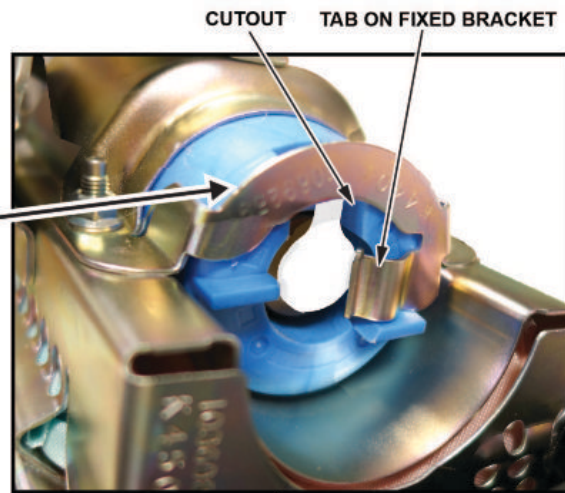
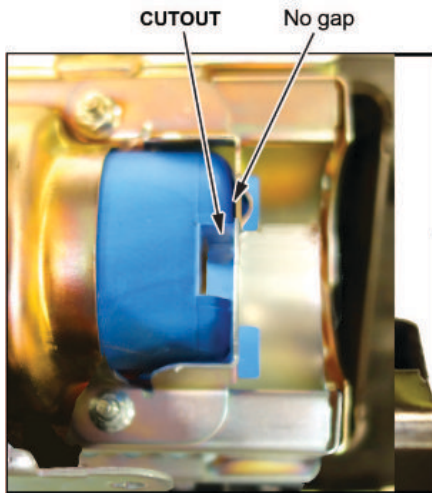

12.3. Install the bracket included in the kit onto the airbag module. Check there is no space or gap between the inflator and bracket by pushing the bracket against the inflator.

NOTE

The bracket may have a little bit of play before you install the new nuts.

ADJUSTABLE BRACKET END

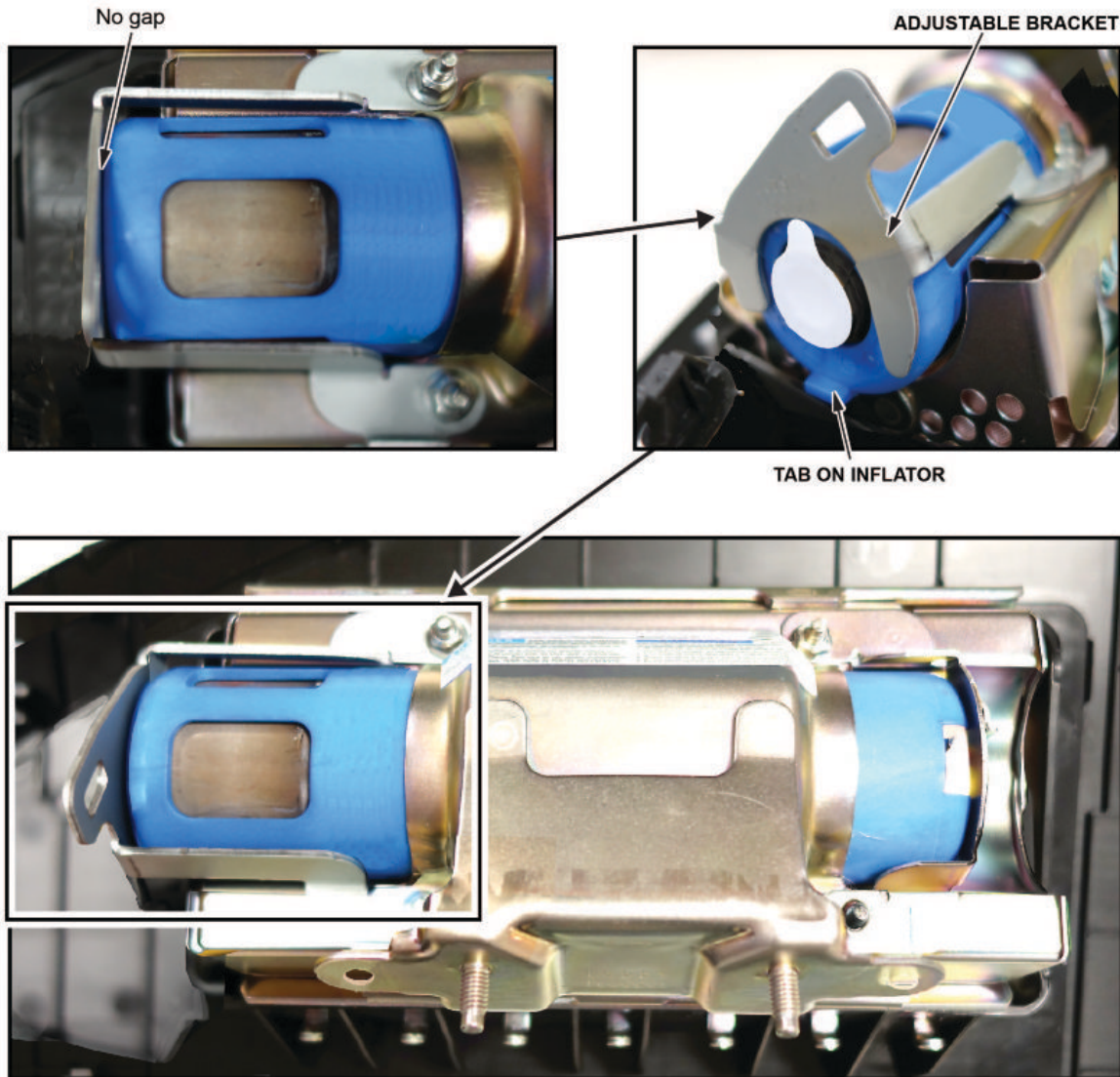

13. Hold the bracket against the inflator, then install the new 5 mm locknuts and torque them in sequence to **3.9 N•m (34 lb-in)**.

NOTE

Make sure you push the bracket against the inflator to ensure there are no gaps between the brackets and inflator when torquing the nuts.

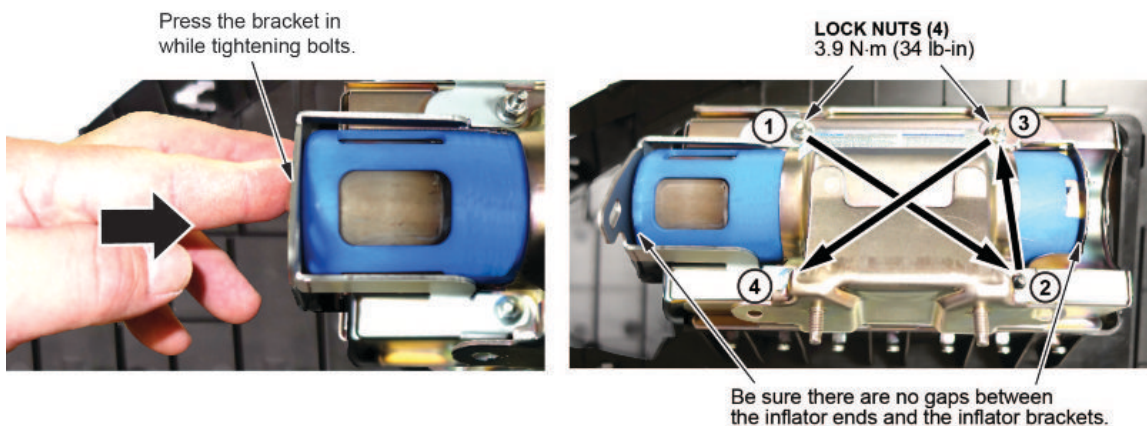

14. Remove the stickers covering the terminals on both sides of the new inflator.



15. Using the V-SMART tool, validate that the airbag replacement inflator is installed correctly.

NOTES

- You must validate the front passenger's airbag replacement inflator installation using the V-SMART tool **before** connecting the inflator harness.
- Your warranty claim will not be paid if the V-SMART validation is not completed or the photo is not sent. Make sure you see the **Uploaded Completed** message to confirm the photo was sent to the warranty department.

16. Install the new inflator harness.

16.1. Make sure the airbag and harness are aligned as shown.

NOTES

- **The replacement inflator harnesses have the wire colors in the opposite positions of the original harness.** If you connect the harness incorrectly, the harness cannot be removed and you will not be able to reinstall the airbag because the harness will be too short.
- Connect the red wire connector to the short collar side of the inflator with the red dot.
- Connect the yellow wire connector to the long collar side of the inflator.
- The red dot may be difficult to see because of the bracket.

ORIGINAL INFLATOR HARNESS ROUTING

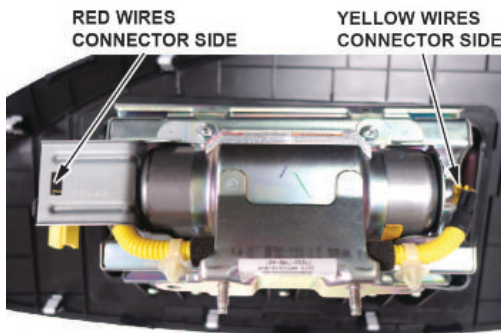

NEW INFLATOR HARNESS ROUTING

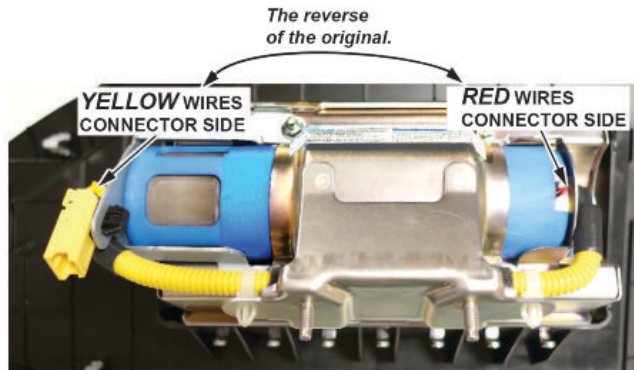

16.2. Connect the red wire connector to the connector on the side with the short plastic collar. Align the “T” shape in the inflator harness connector with the T-shaped inflator connector, then press the connector into place.

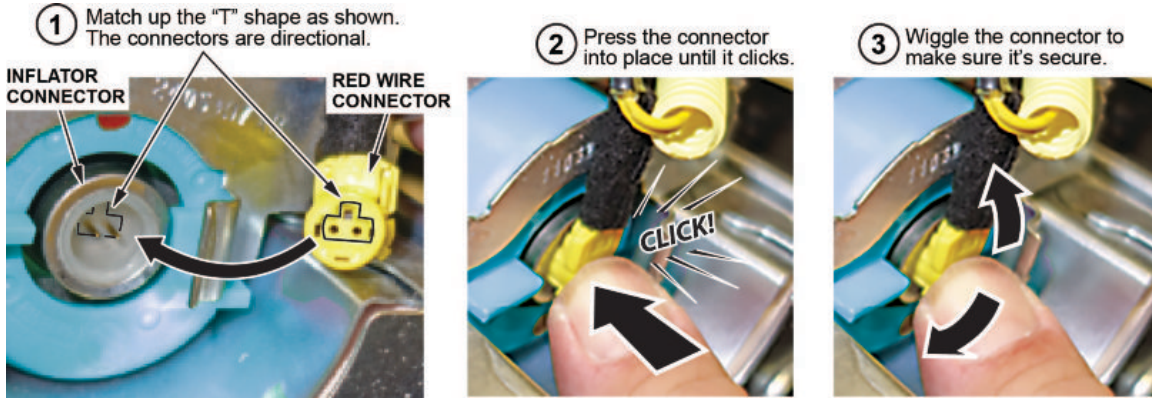

16.3. Connect the yellow wire connector to the connector on the side with the long plastic collar.

16.4. After you hear each connector click, wiggle it to make sure it is secure.

NOTE

If the connector is not properly aligned, it will come out.

16.5. Make sure the connector is secure and in place by using the gauge tool. (PSPI6 Gauge Tool P/N: 070AJ-TA00A00 or 07AAJ-TA0AA00).

Be sure the connector is fully seated by checking it with the gauge tool.

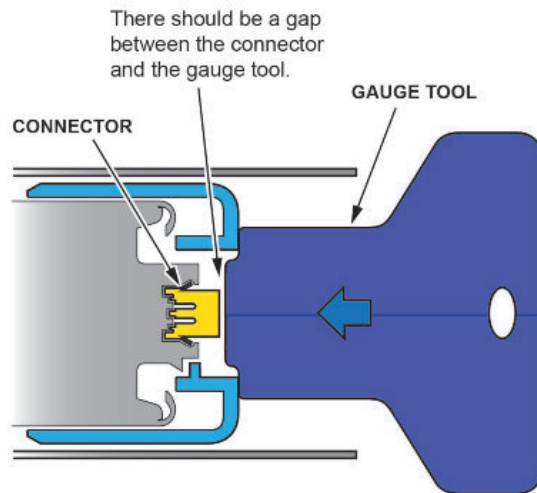
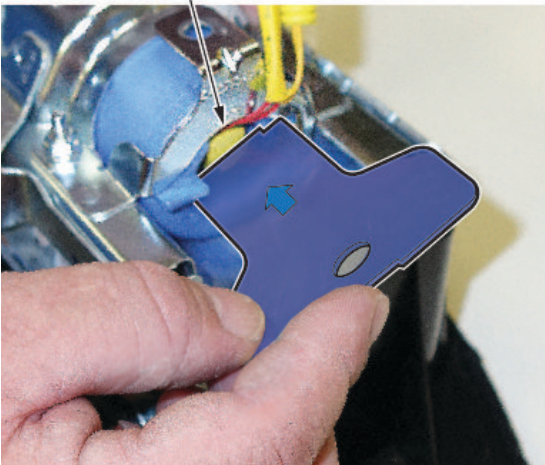

17. Connect the harness to the inflator brackets.
 - 17.1. Connect the harness clips as shown.
 - 17.2. Attach the 4-pin connector to the bracket as shown.

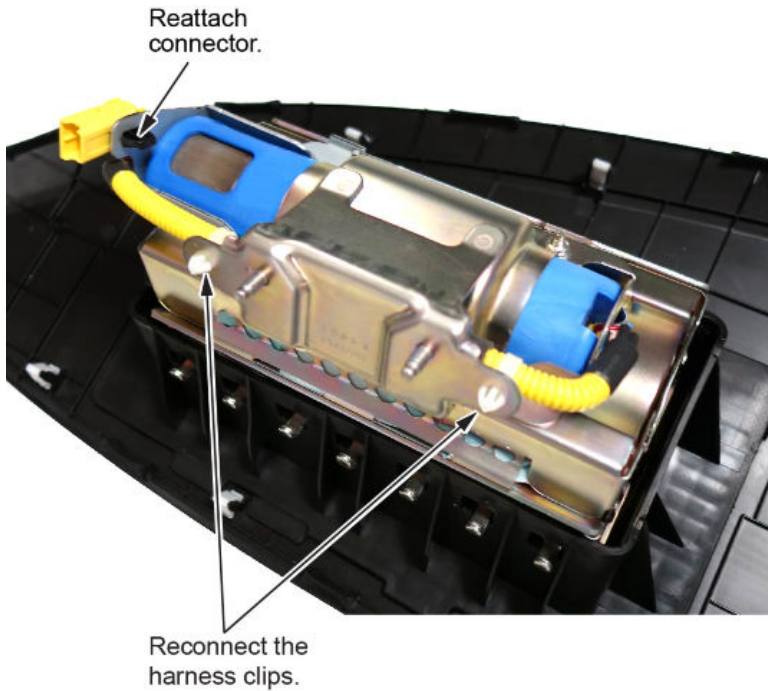

18. Reinstall the passenger's airbag into the vehicle and torque the new locknuts to **9.8 N•m (7.2 lb-ft)**.
19. Reconnect the battery negative cable and enter the anti-theft code for the audio and navigation system (if applicable), then enter the audio presets.
20. Set the clock (for vehicles without navigation).
21. Turn the ignition to ON and make sure the SRS indicator comes on for about 6 seconds, then goes off.
22. Put the original inflator into the box the new one came in. Make sure there is no other hardware in the box because if the package rattles, it will not be accepted by the courier.
23. Follow the shipping instructions outlined in PIB A15-0002 to return the undeployed inflator.
24. Give your warranty clerk the RO that includes the replacement inflator serial number and replacement part number. For the warranty claim to be paid, the **replacement inflator part number** must be included in the warranty claim.

NOTES

- If the VIN status inquiry indicates that the vehicle is subject to any open safety recalls, including the driver's airbag inflator, make sure to also complete those recall repairs before returning the vehicle to the customer. If you are unable to complete any open recall, advise the customer of the recall status and when the recall could be completed.
 - Make sure you have the anti-theft code for the audio and navigation system (if applicable), then write down the frequencies for the radio's preset buttons.
 - Be careful not to damage any parts when replacing the inflator, and **follow the procedure exactly**.
 - If, before removing the airbag, you suspect that it may be the incorrect airbag for the vehicle or a counterfeit, **do not remove the airbag**. Contact your DPSM for assistance.
 - Make sure you have reviewed the SRS Precautions and Procedures in the service information before doing the REPAIR PROCEDURE.
1. Turn the ignition switch to the ON (II) position and check if the SRS indicator comes on for about 6 seconds, then turns off.
 - If the indicator comes on, then turns off after about 6 seconds, go to step 2.
 - If the indicator does not come on, or if it stays on, contact your DPSM for assistance.
 2. Disconnect the battery negative cable and wait at least 3 minutes before continuing.
 3. Remove the front passenger's airbag.
 - 3.1. Remove the front passenger's dashboard trim by referring to the service information.
 - 3.2. Disconnect the front passenger's airbag 4P connector from the dashboard wire harness.

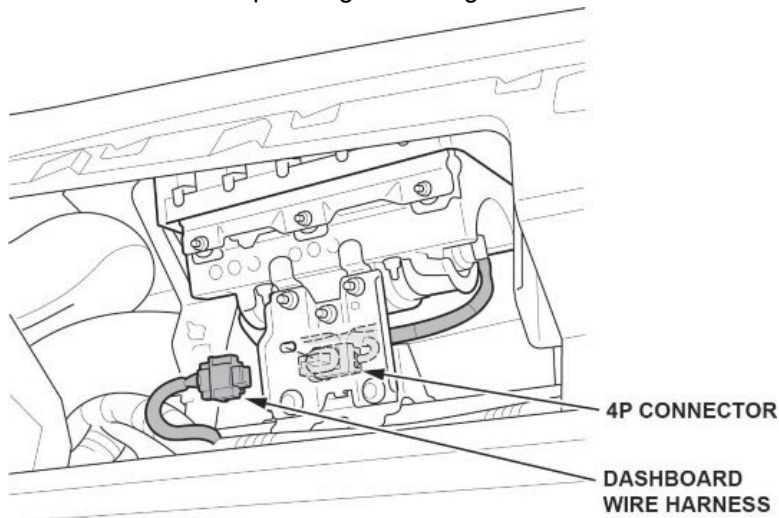

3.3. Remove the mounting nuts and bolts to remove the bracket.

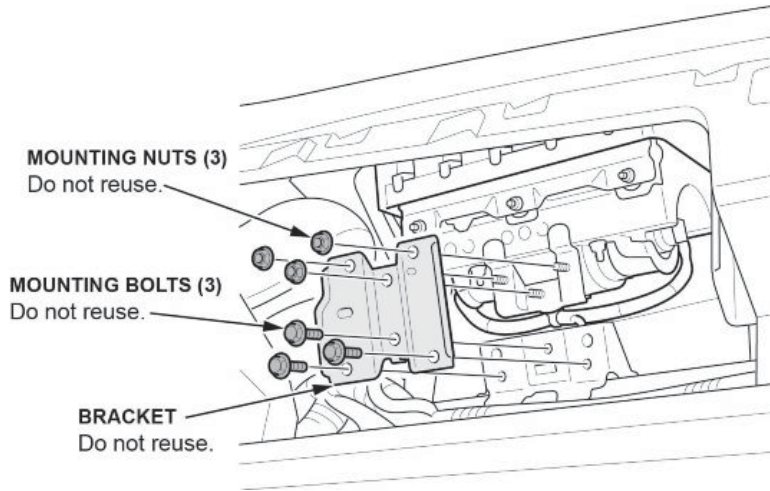

3.4. Remove the mounting nuts from the hook plate.

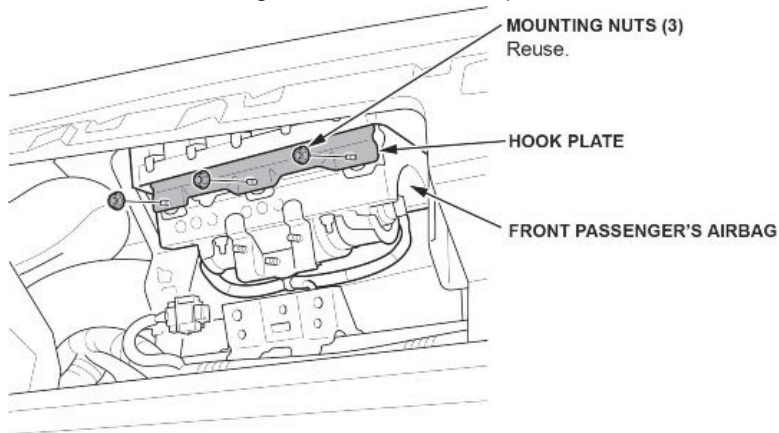

3.5. Release the hooks on the hook plate from the front passenger's airbag housing and remove the hook plate.

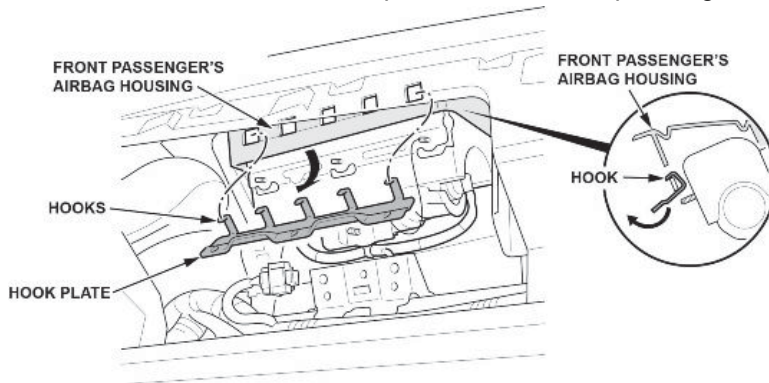

3.6. Remove the front passenger's airbag.

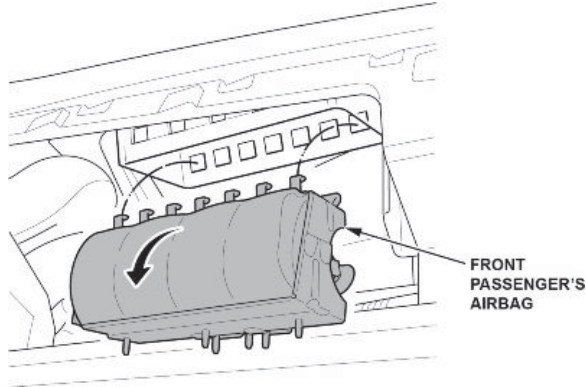

4. Place the airbag, face-down, on a clean shop towel.

NOTE

The orientation of the airbag is critical because if the inflator is installed incorrectly, the harness will be too short when you reinstall the airbag.

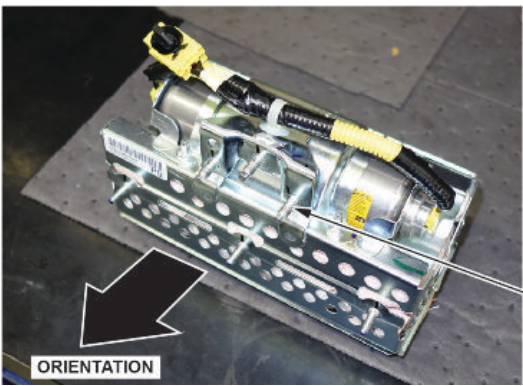

5. Visually inspect the airbag and the inflator for any unusual writing or markings. Refer to IDENTIFYING COUNTERFEIT AIRBAGS.

6. Peel the label located inside the inflator box from its backing and attach it to the RO. For the warranty claim to be paid, the **replacement inflator part number that you received** must be included in the warranty claim.

NOTES

- The replacement part number is printed on the top part of the label and the serial number is printed on the bottom. **Make sure you attach the label to the RO and give it to the warranty clerk .**
- There may also be a colored sticker located in the kit, ignore it because it is not used.
- Not all inflator kits have a label included. In those cases, write the serial number and part number from the side of the inflator box on the RO. The part number always starts with 047.

PASSENGER INFLATOR PARTS BOX

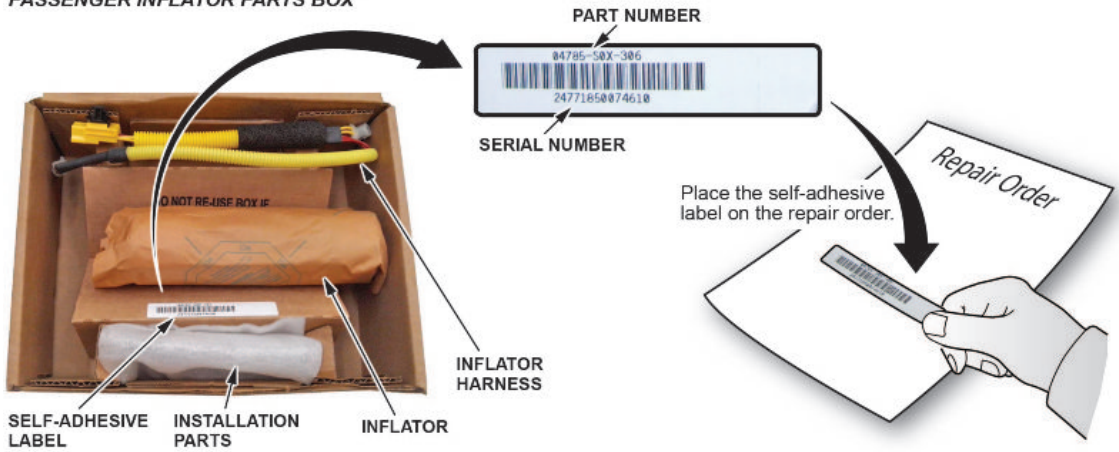

7. Remove the harness from the inflator bracket.
Release harness clip.

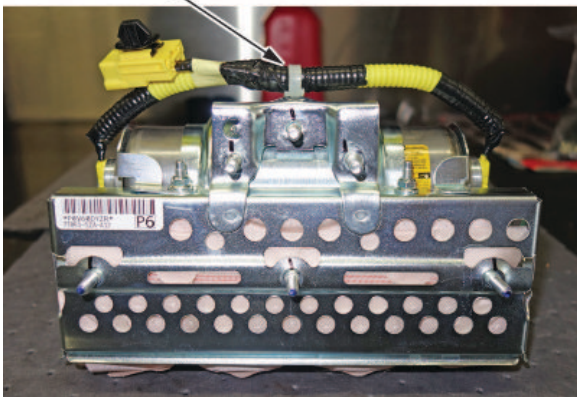

8. Short the yellow wires.

NOTES

- **You must cut the yellow wires** for inflator removal and short the yellow wires on the inflator side as indicated to prevent accidental deployment.
- **Do not cut the red wires** because the airbag connector shorts these inflator wires.
- There is glue securing the black insulation to the yellow wires. Be careful not to cut the wires when removing the insulation.

8.1. Cut the yellow wires as shown.

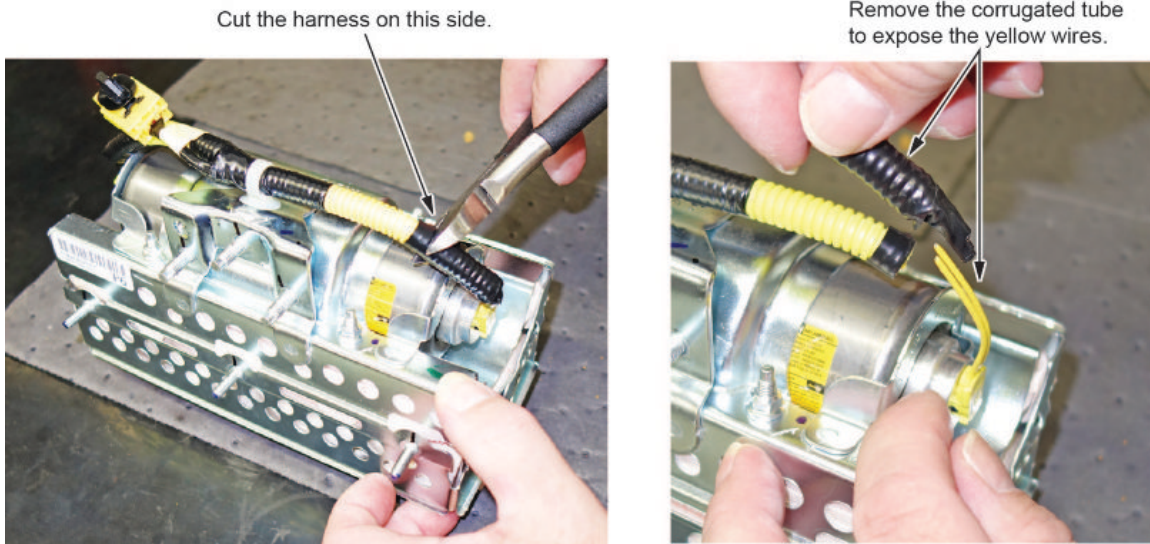

8.2. Strip away about 1 inch of the yellow wire insulation, then twist the wires together.

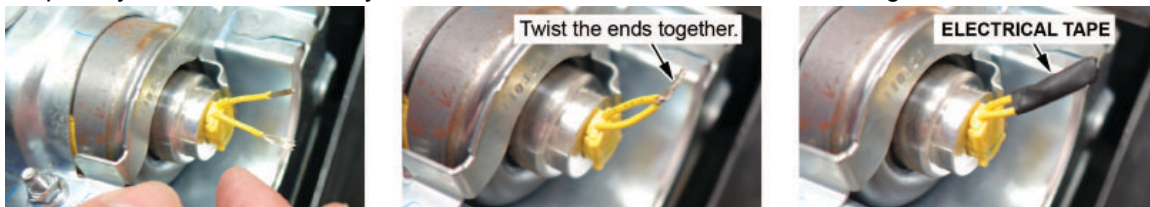

8.3. Tape the twisted ends with electrical tape.

9. Remove the four inflator nuts.

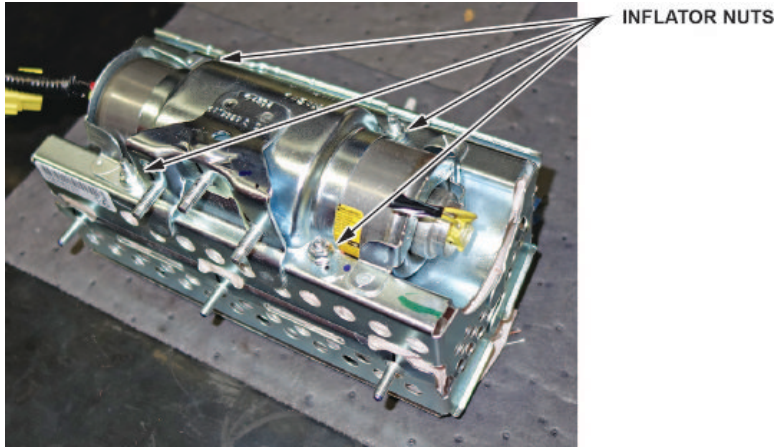

10. Remove the inflator bracket.

NOTES

- You can only remove one of the brackets, as the other is welded to the airbag housing.
- Do not reuse the bracket; use the new one that came in the inflator kit.

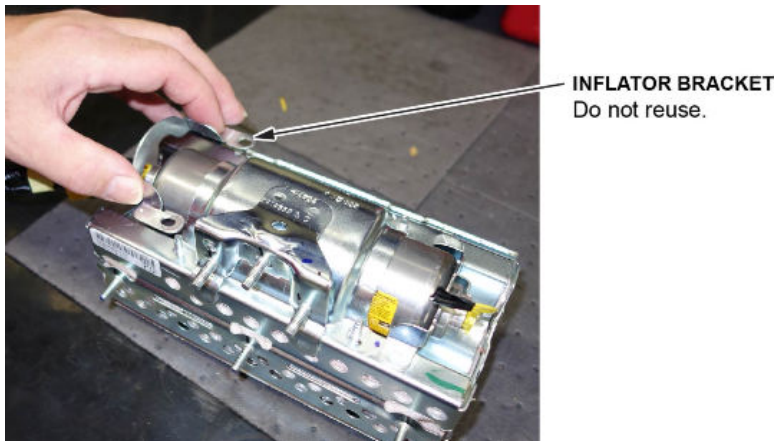

11. Remove the inflator by pulling it out.

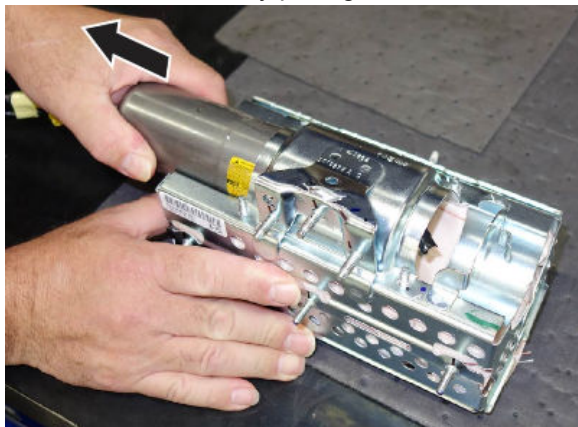

12. Install the new inflator.

NOTE

There may be some minor surface rust or corrosion on the new inflator; this is OK.

P/N 04790-SZA-407 or 04790-SZA-A00

12.1. One side of the inflator has a longer collar, a single tab, a plastic cutout, and a small flat spot on the connector. The other side of the inflator has a shorter collar, two tabs, and a red dot. **Make sure you insert the end with the shorter collar into the airbag first.**

NOTES

- The V-SMART tool can only validate inflators with slotted end caps. You may receive an inflator with solid end caps. This is the correct part to repair the vehicle, but the V-SMART will fail the validation. **The V-SMART validation must fail a total of three times** before you can have your supervisor override the validation using the **Supervisor Inspection Override**.
- Your supervisor can be a service manager, shop foreman, team leader, etc. **The supervisor must inspect your work** to make sure the replacement inflator was installed correctly. When a supervisor enters his or her information, **the supervisor is signing off that the technician's work was inspected and approved.**

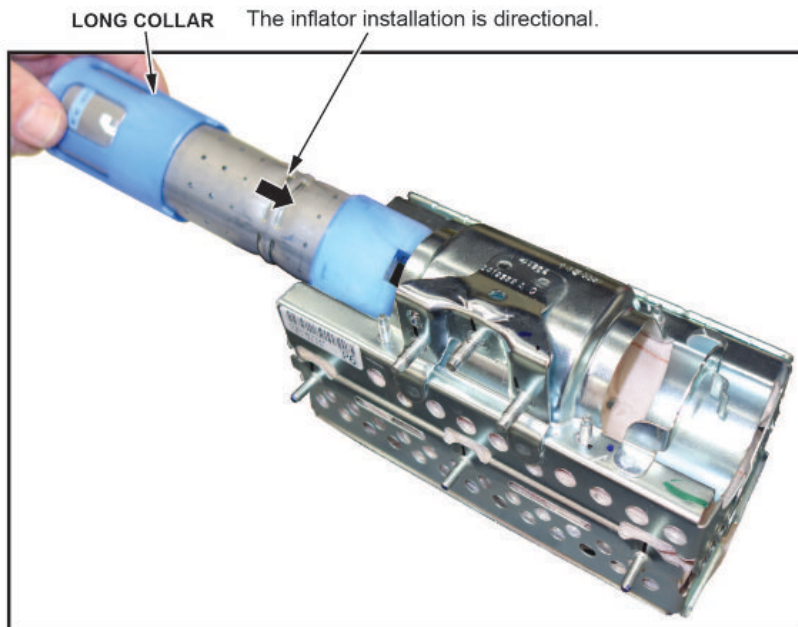
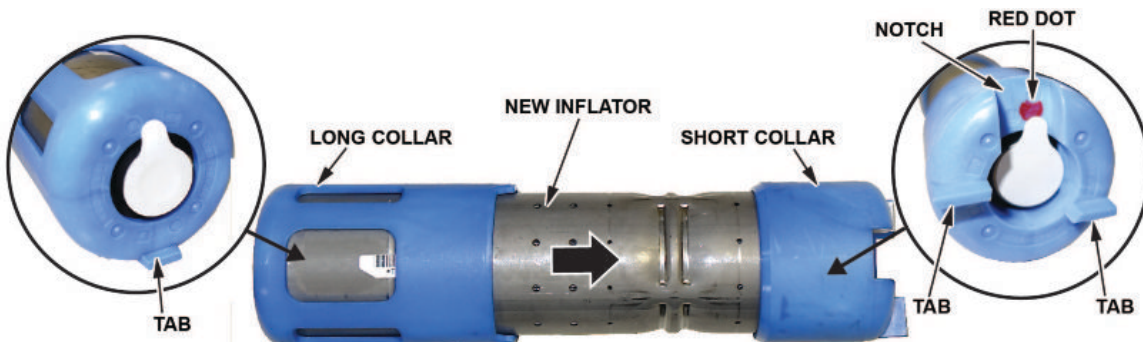

12.2. Slide the inflator in until the plastic collar contacts the bracket. The two tabs should align with the side of the airbag module and the metal tab as shown. There should be no space or gap between the inflator and bracket.

FIXED BRACKET END

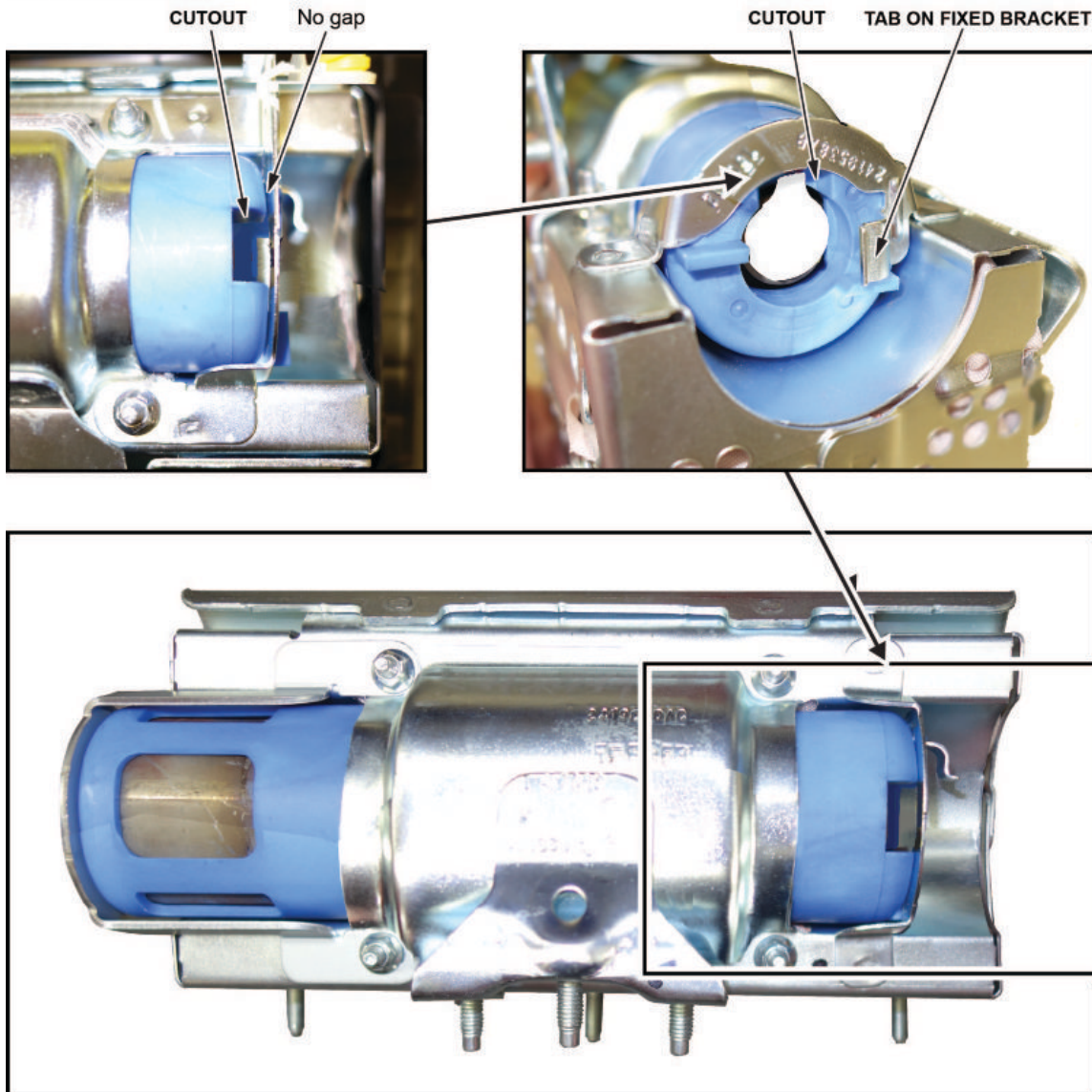

- 12.3. Install the bracket included in the kit onto the airbag module. Check there is no space or gap between the inflator and bracket by pushing the bracket against the inflator.

NOTE

The bracket may have a little bit of play before you install the new nuts.

ADJUSTABLE BRACKET END

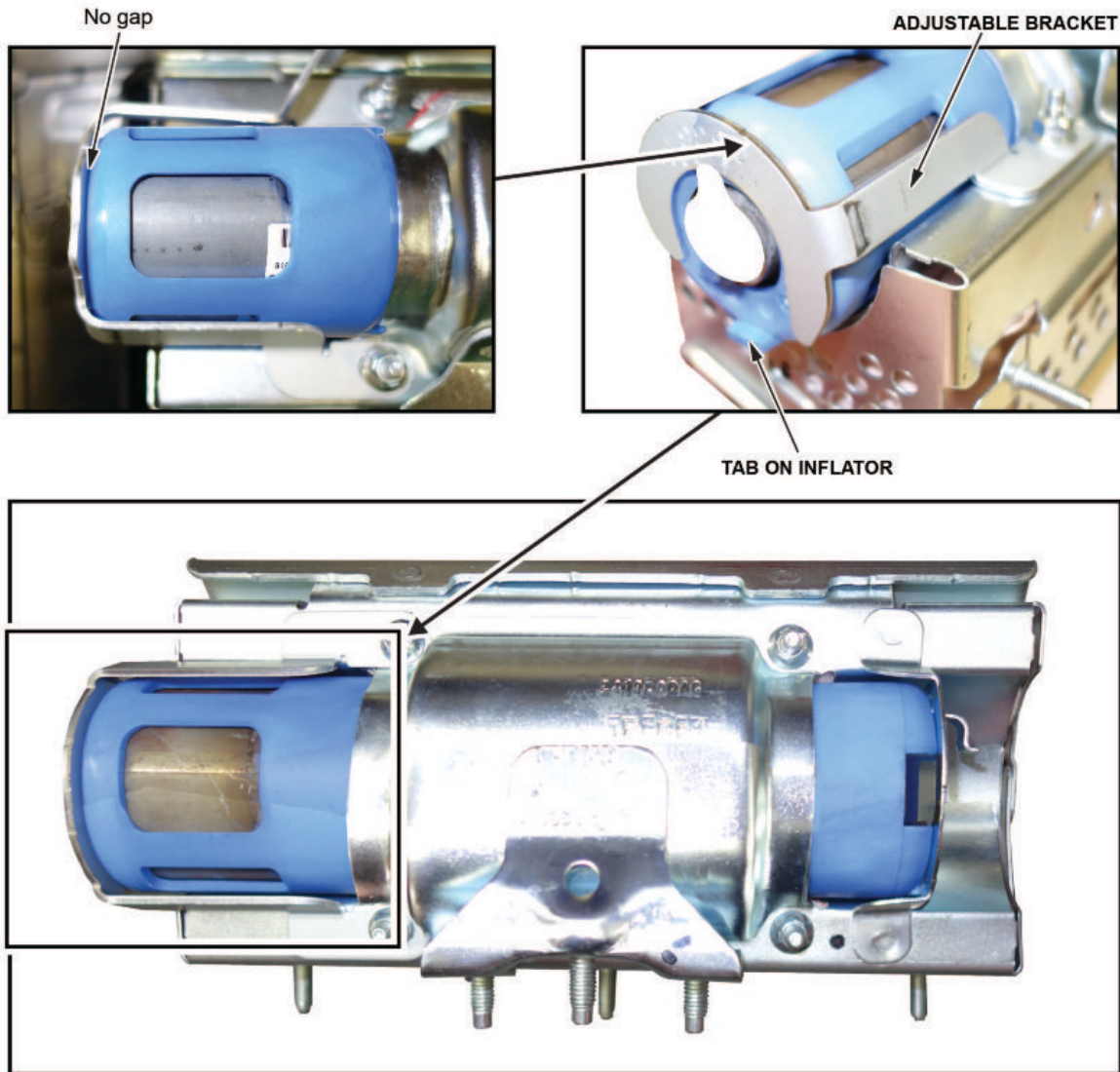

13. Hold the bracket against the inflator, then install the new 5 mm locknuts and torque them in sequence to **3.9 N•m (34 lb-in)**.

NOTE

Make sure you push the bracket against the inflator to ensure there are no gaps between the brackets and inflator when torquing the nuts.

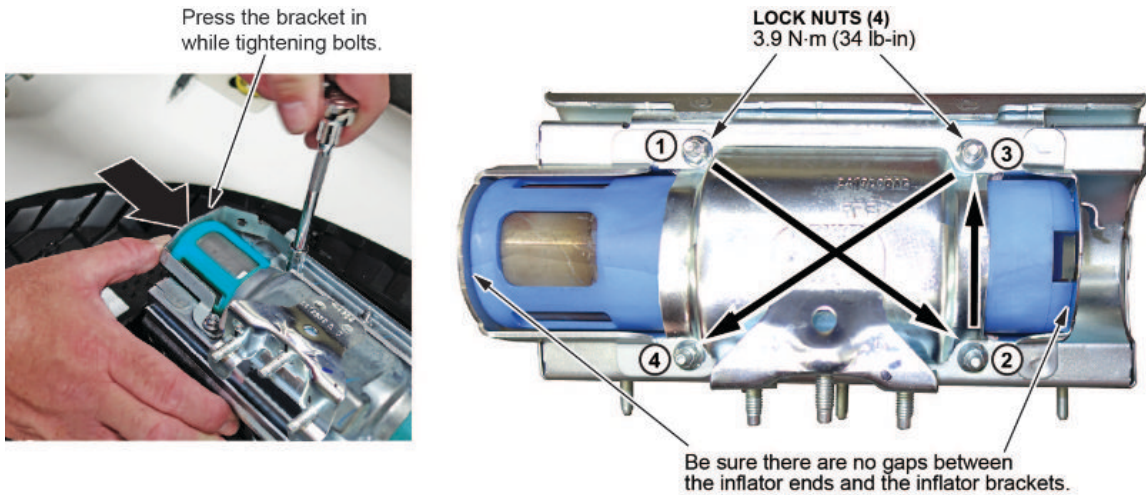

14. Remove the stickers covering the terminals on both sides of the new inflator.

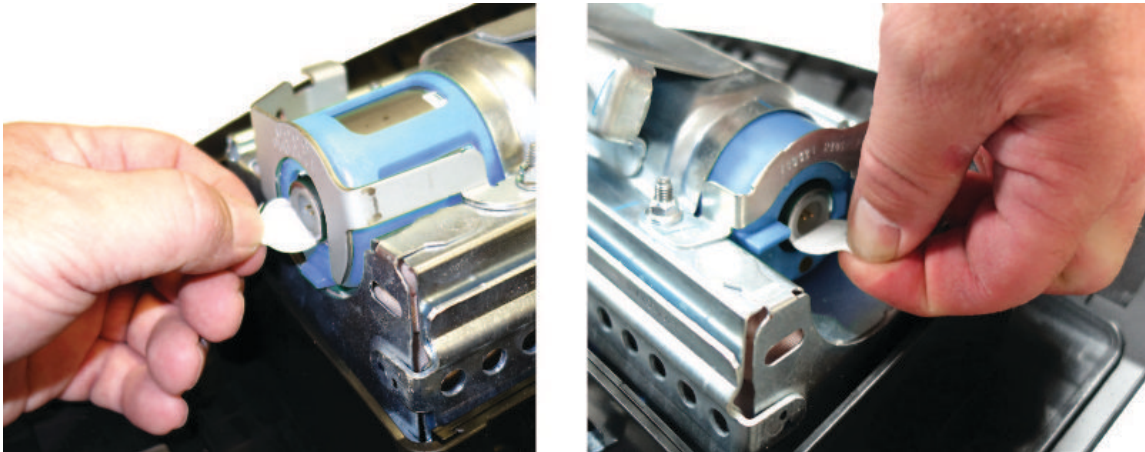

15. Using the V-SMART tool, validate that the airbag replacement inflator is installed correctly.

NOTES

- You must validate the front passenger's airbag replacement inflator installation using the V-SMART tool **before** connecting the inflator harness.
- Your warranty claim will not be paid if the V-SMART validation is not completed or the photo is not sent. Make sure you see the **Uploaded Completed** message to confirm the photo was sent to the warranty department.

16. Install the new inflator harness.

16.1. Make sure the airbag and harness are aligned as shown.

NOTES

- **The replacement inflator harnesses have the wire colors in the opposite positions of the original harness.** If you connect the harness incorrectly, the harness cannot be removed and you will not be able to reinstall the airbag because the harness will be too short.
- Connect the red wire connector to the short collar side of the inflator with the red dot.
- Connect the yellow wire connector to the long collar side of the inflator.
- The red dot may be difficult to see because of the bracket.

ORIGINAL INFLATOR HARNESS ROUTING

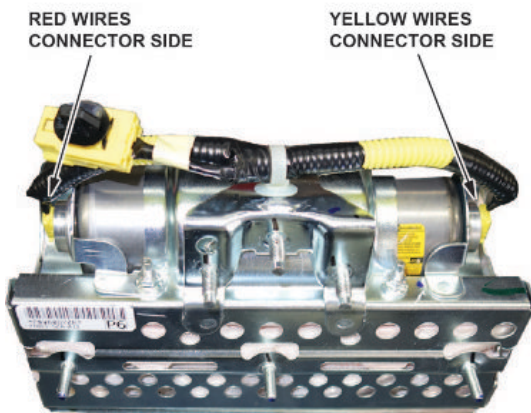

NEW INFLATOR HARNESS ROUTING

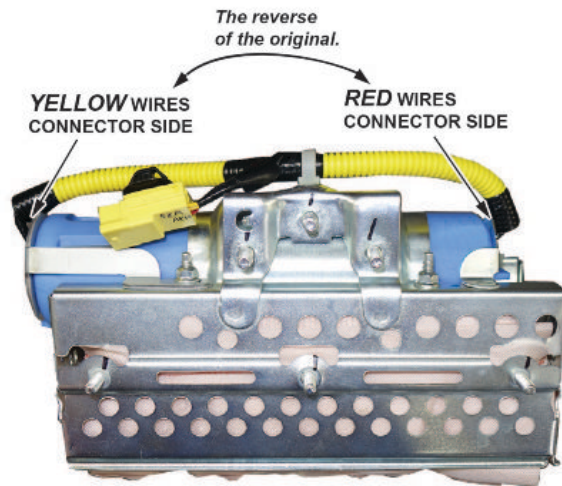

16.2. Connect the red wire connector to the connector on the side with the short plastic collar. Align the "T" shape in the inflator harness connector with the T-shaped inflator connector, then press the connector into place.

- ① Match up the "T" shape as shown. The connectors are directional.

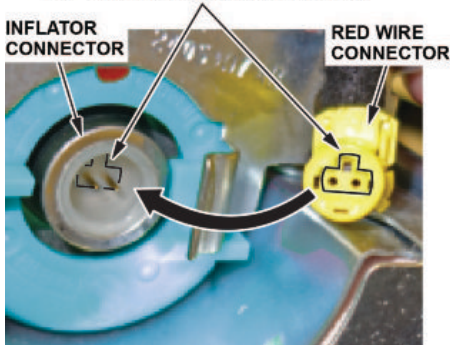

- ② Press the connector into place until it clicks.



- ③ Wiggle the connector to make sure it's secure.



16.3. Connect the yellow wire connector to the connector on the side with the long plastic collar.

16.4. After you hear each connector click, wiggle it to make sure it is secure.

NOTE

If the connector is not properly aligned, it will come out.

16.5. Make sure the connector is secure and in place by using the gauge tool. (PSP16 Gauge Tool P/N: 070AJ-TA00A00 or 07AAJ-TA0AA00).

Be sure the connector is fully seated by checking it with the gauge tool.

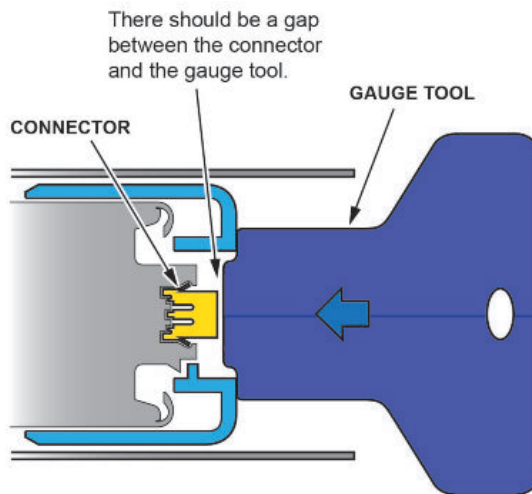
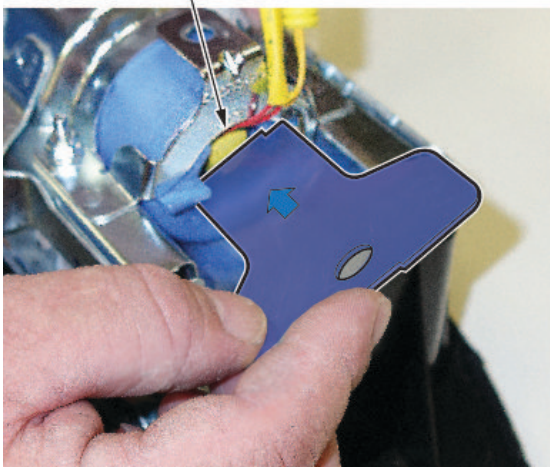

17. Connect the harness to the inflator brackets.

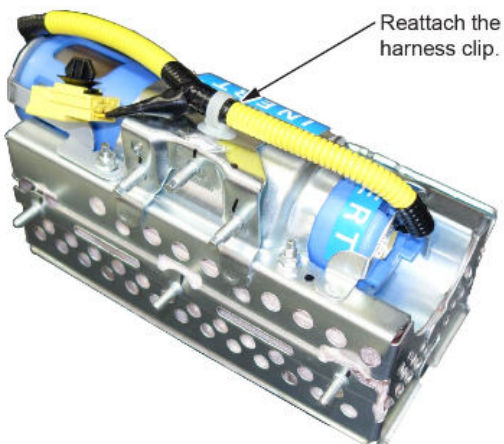

18. Install the front passenger's airbag with the new inflator.

18.1. Install the hooks of the front passenger's airbag into the front passenger's airbag housing.

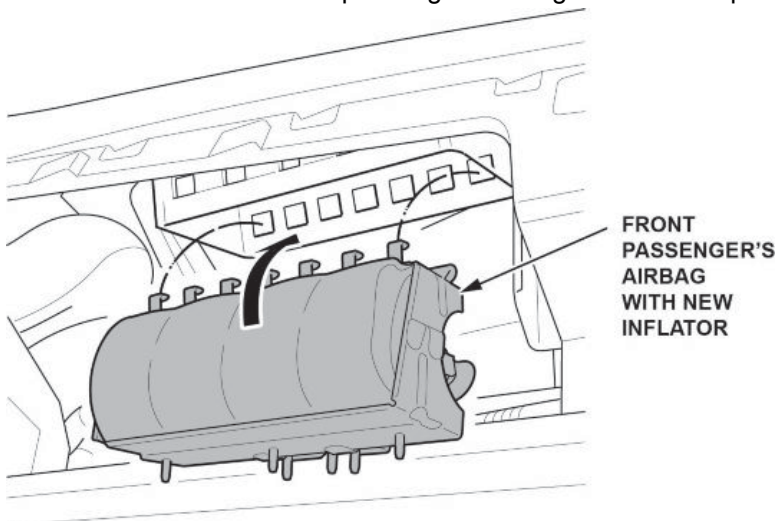

18.2. Insert the hooks of the hook plate into the front passenger's airbag housing.

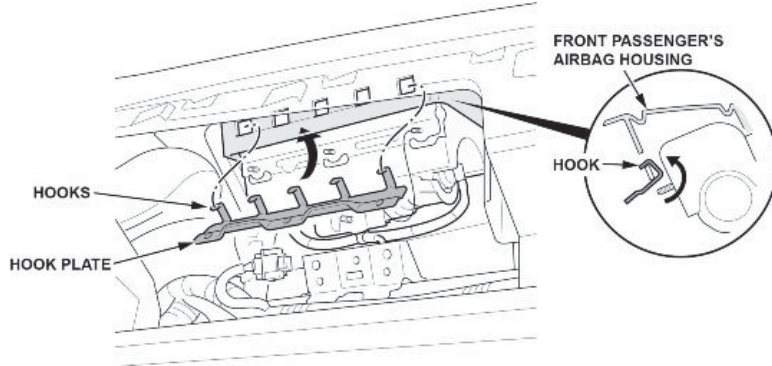

18.3. Install the hook plate with the original mounting nuts.

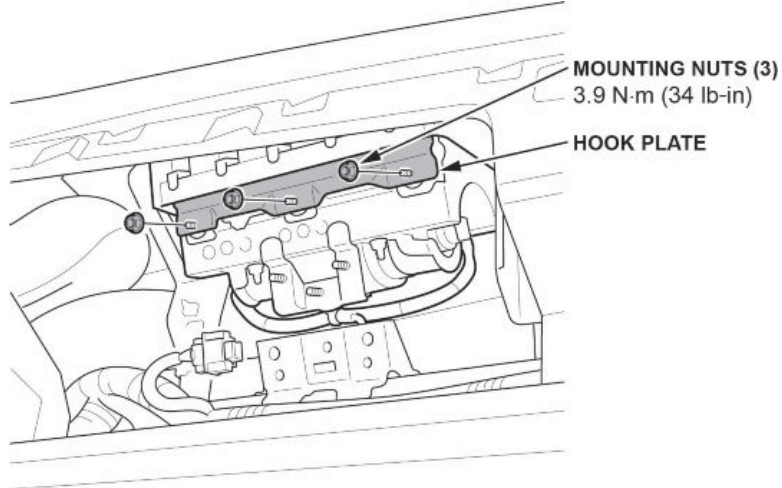

18.4. Install the new support bracket with the new mounting nuts and torque them to 9.4 N·m (6.9 lb-ft), then loosely install the new bolts.

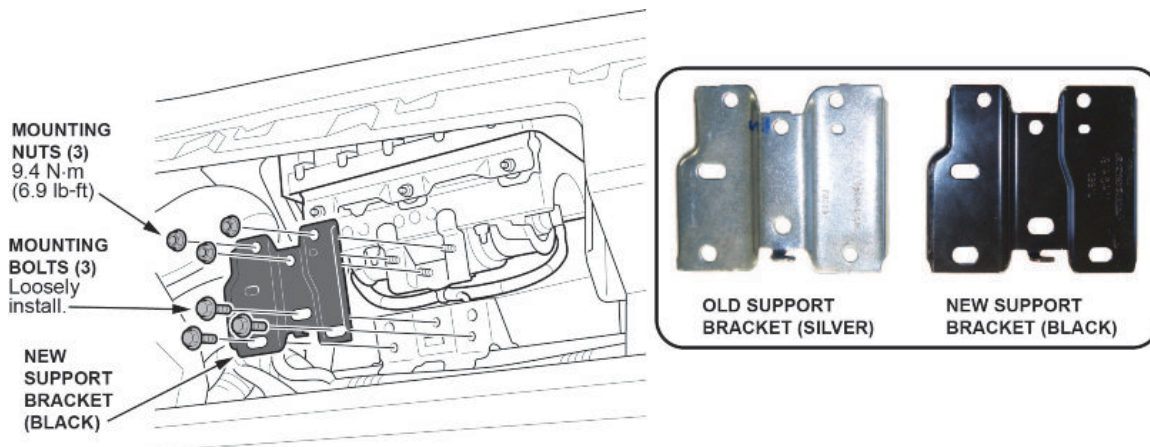

18.5. Push the bracket to the left and hold it while torquing the mounting bolts to 9.4 N·m (6.9 lb-ft).

NOTE

You must keep the bracket pushed to the left to make sure there is more than 5 mm between the inflator connector and the bracket as shown.

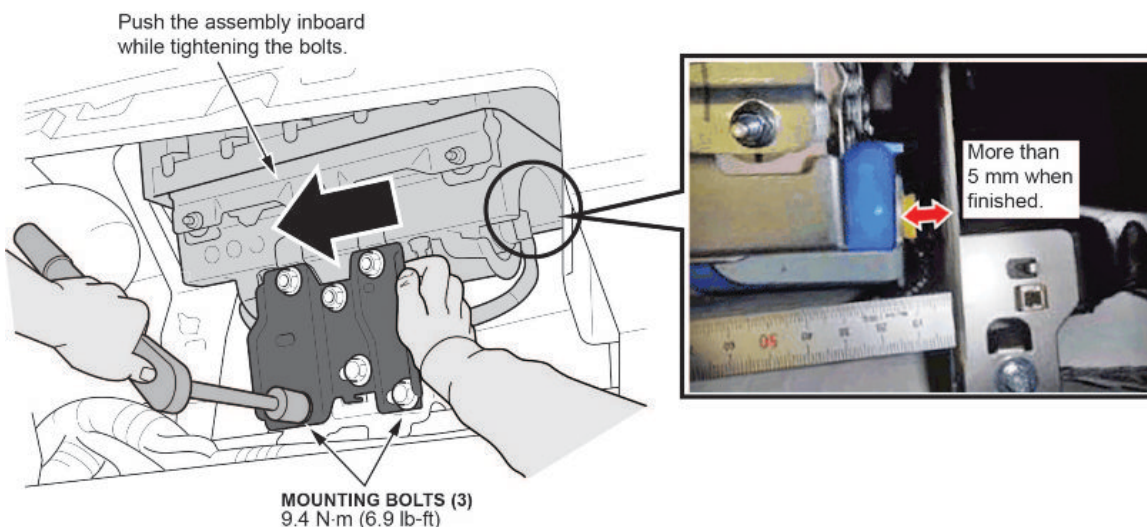

18.6. Connect the dashboard wire harness 4P connector to the front passenger's airbag 4P connector then install the connector clip.

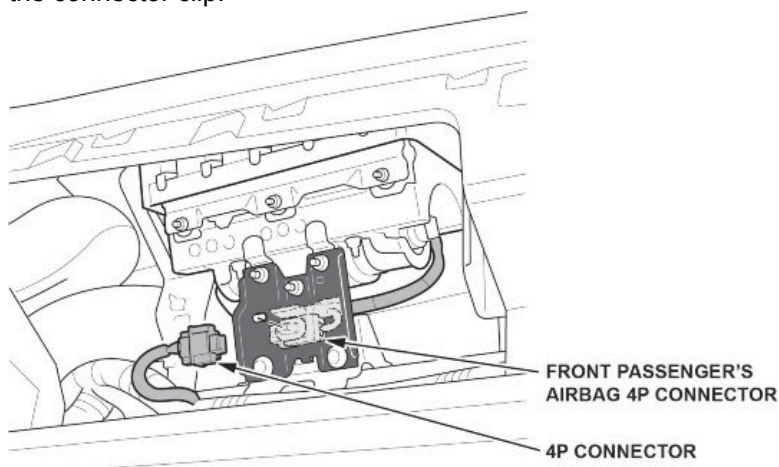

- 18.7. Install the passenger's dashboard trim by referring to the service information.
19. Reconnect the battery negative cable and enter the anti-theft code for the audio and navigation system (if applicable), then enter the audio presets.
20. Set the clock (for vehicles without navigation).
21. Turn the ignition to ON and make sure the SRS indicator comes on for about 6 seconds, then goes off.
22. Put the original inflator into the box the new one came in. Make sure there is no other hardware in the box because if the package rattles, it will not be accepted by the courier.
23. Follow the shipping instructions outlined in PIB A15-0002 to return the undeployed inflator.
24. Give your warranty clerk the RO that includes the replacement inflator serial number and replacement part number. For the warranty claim to be paid, the **replacement inflator part number** must be included in the warranty claim.

END