



Volvo Car Customer Service

QB Instruction VCC-501267-2

Title	Inflatable curtain	Page	1 (15)
Action	Inspection		

Issue	Date	Reason
1	2017-02	First issue

Affected vehicles

Model year	Model
2017	S90 (17-)

Equipment

Designation	Part No.
Electrician's screwdriver	
Interior trim remover	

Orientation view

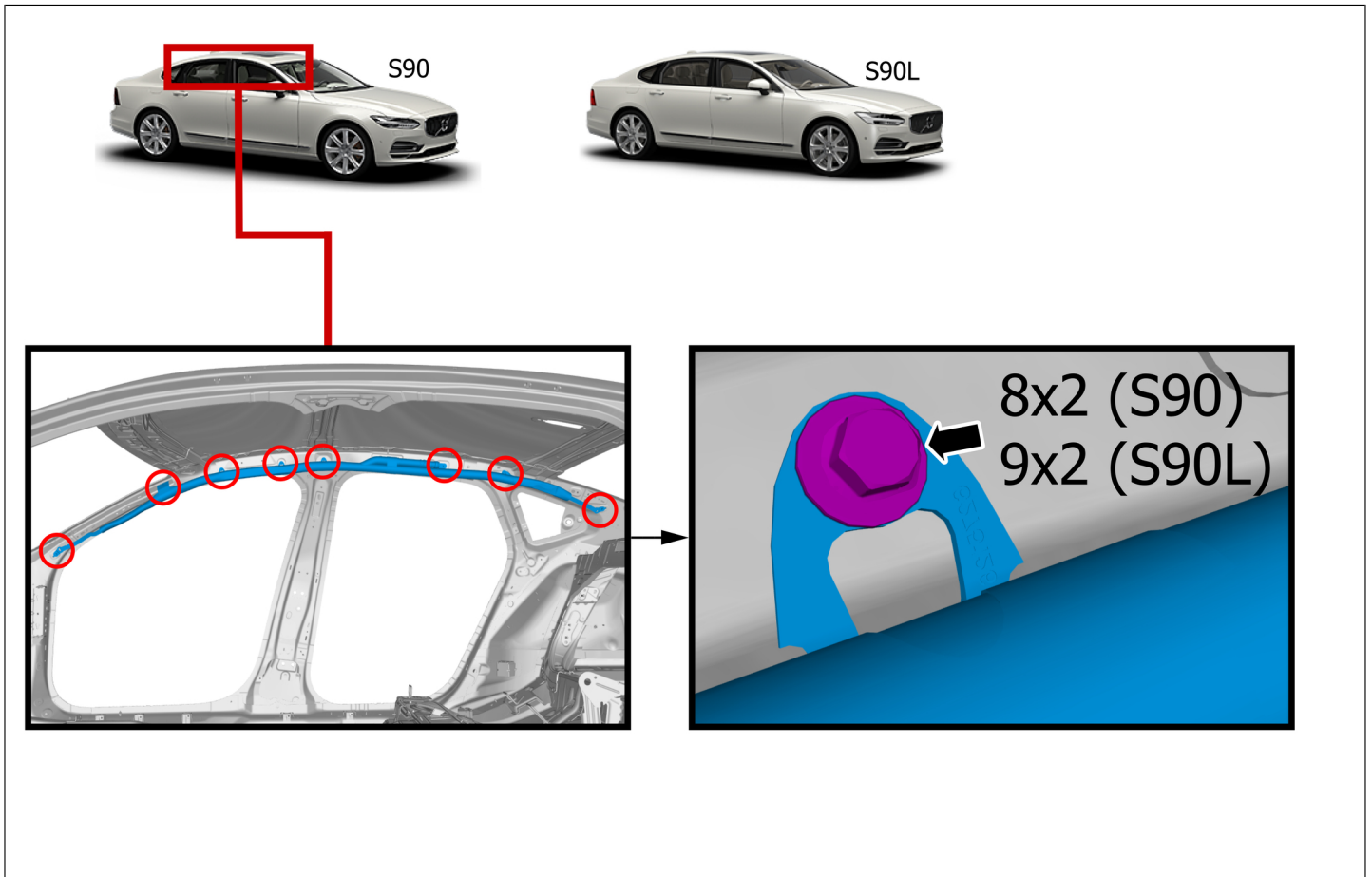

Color symbols

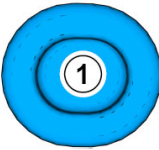
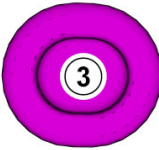
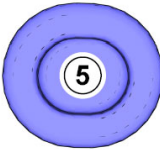
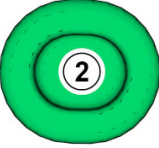
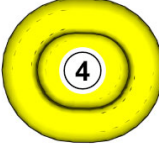
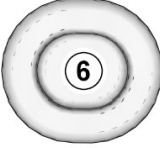
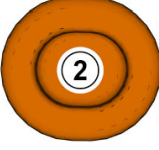

Note! This colour chart displays (in colour print and electronic version) the importance of the different colours used in the images of the method steps.

- 1 . Used for focused component, the component with which you will do something.
- 2 . Used as extra colors when you need to show or differentiate additional parts.
- 3 . Used for attachments that are to be removed/installed. May be screws, clips, connectors, etc.
- 4 . Used when the component is not fully removed from the vehicle but only hung to the side.
- 5 . Used for standard tools and special tools.
- 6 . Used as background color for vehicle components.

Note! Removal steps in this procedure may contain installation details.

On both sides.

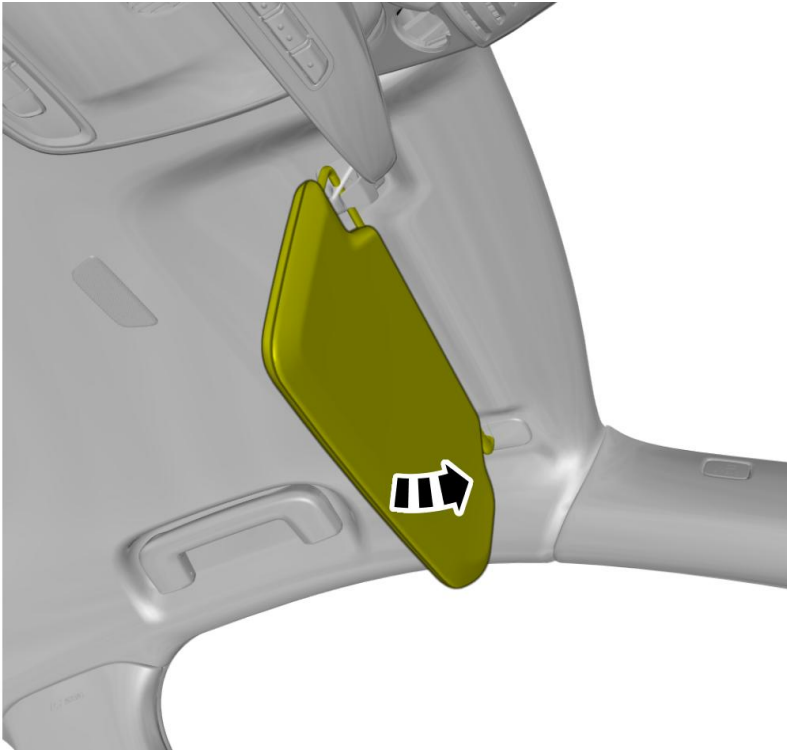

On both sides.

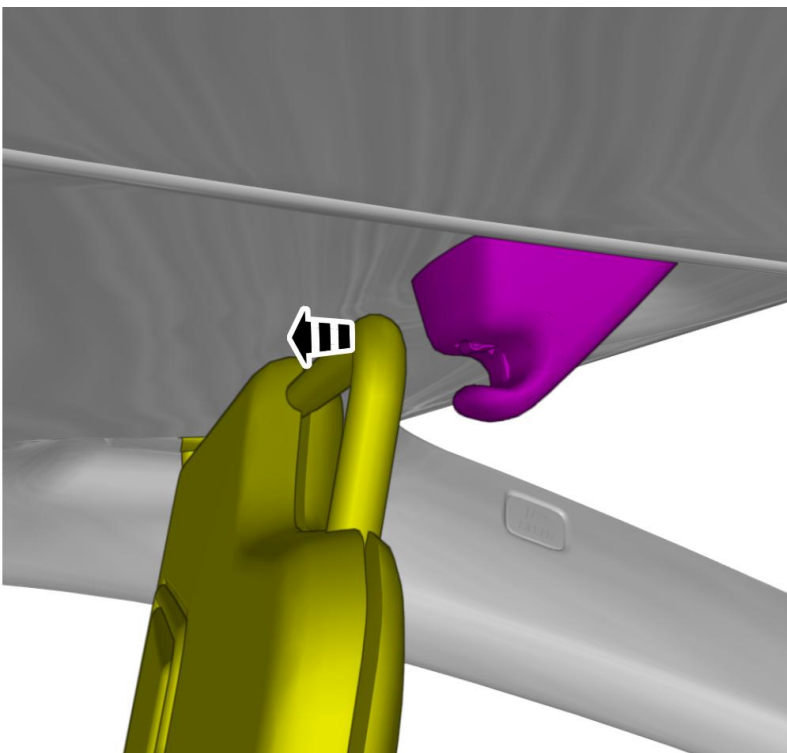

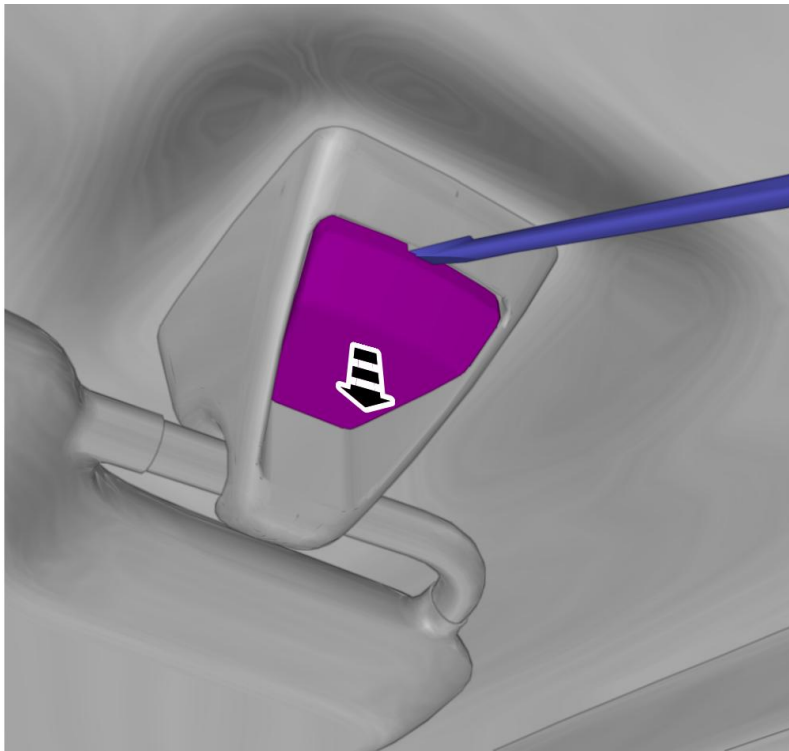

Caution! Take extra care when handling the component.

On both sides.

Use: Electrician's screwdriver

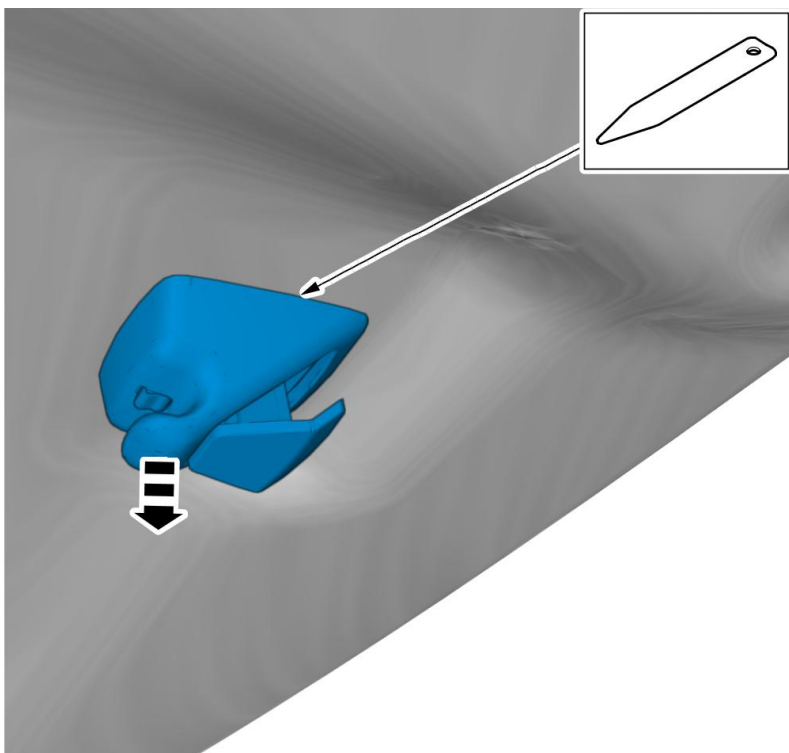

Remove the marked part.

On both sides.

Use: Interior trim remover

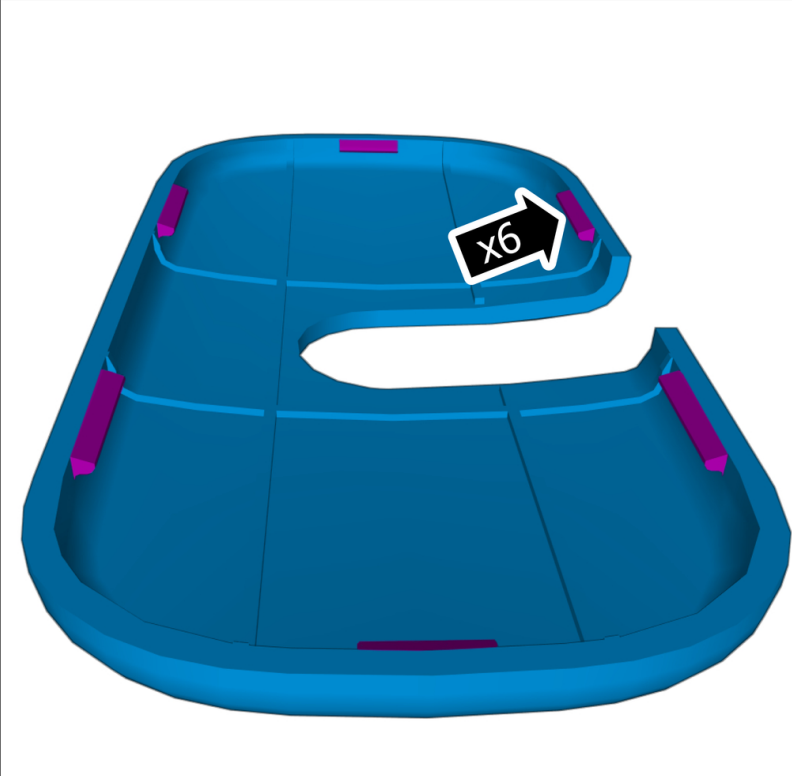

Note! The graphic shows the back of the component before removal.

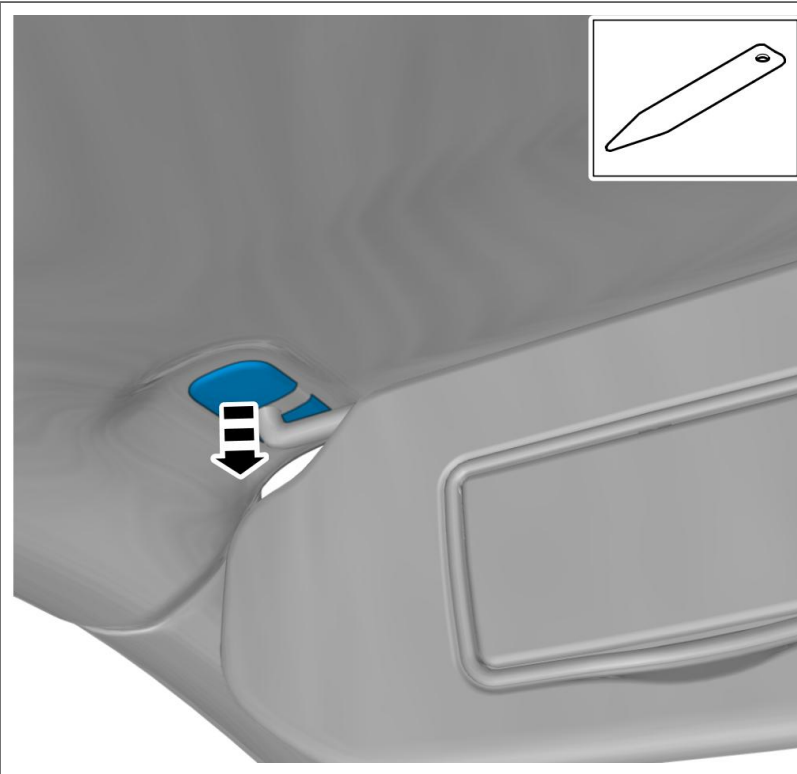

Remove the marked part.
On both sides.

Use: Interior trim remover

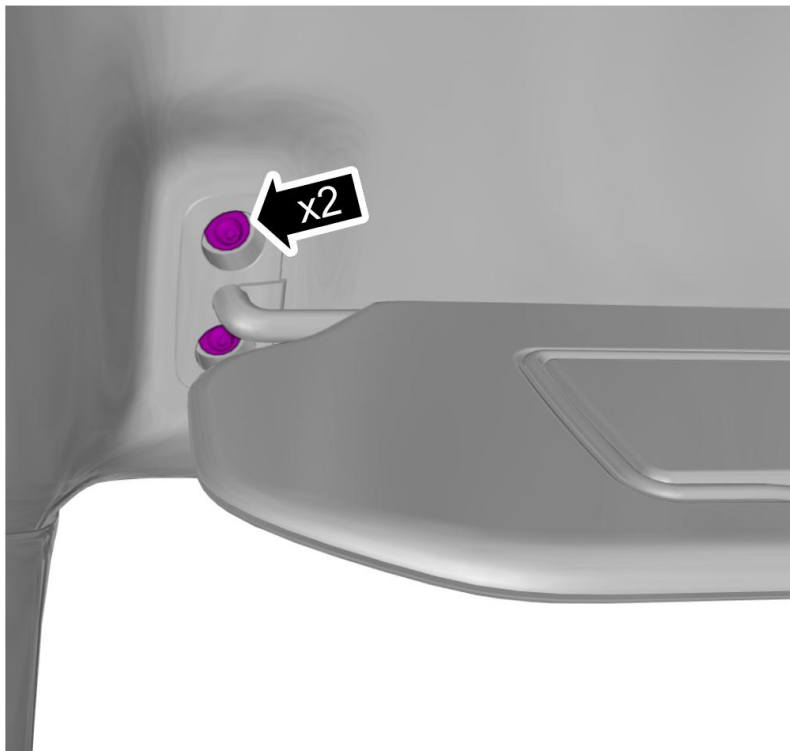

Remove the screws.
On both sides.

Torque:
M5 , 5 Nm

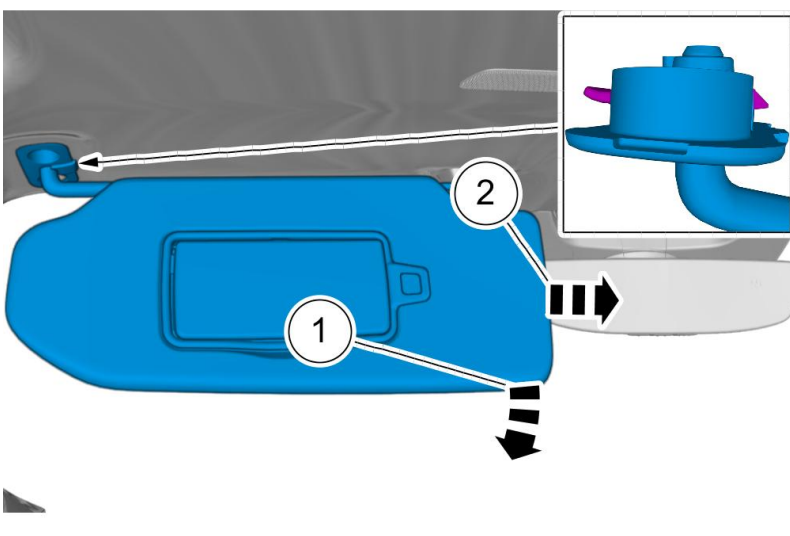

Remove the part carefully
Fold marked part to one side.
On both sides.

Remove panel A-pillar , refer to:
Removal, replacement and installation
8 - Body and interior
85 - Interior
851 - upholstery for wall/door, side, rear
shelf, luggage rack

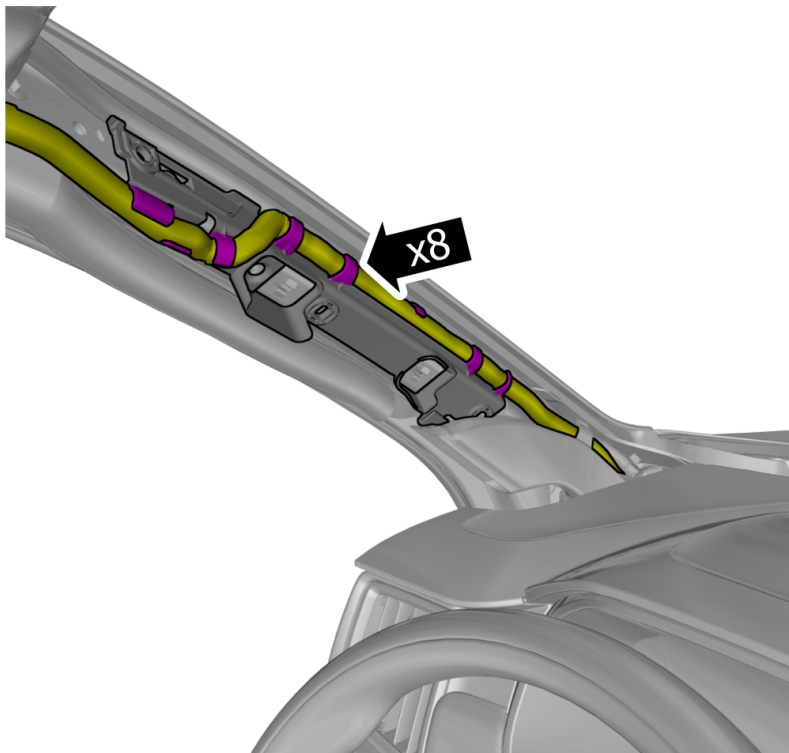

Loosen the wiring harness or move it to the side.
On both sides.

Remove rear-view mirror inside , refer to:
Removal, replacement and installation
8 - Body and interior
88 - Interior equipment
882 - interior equipment

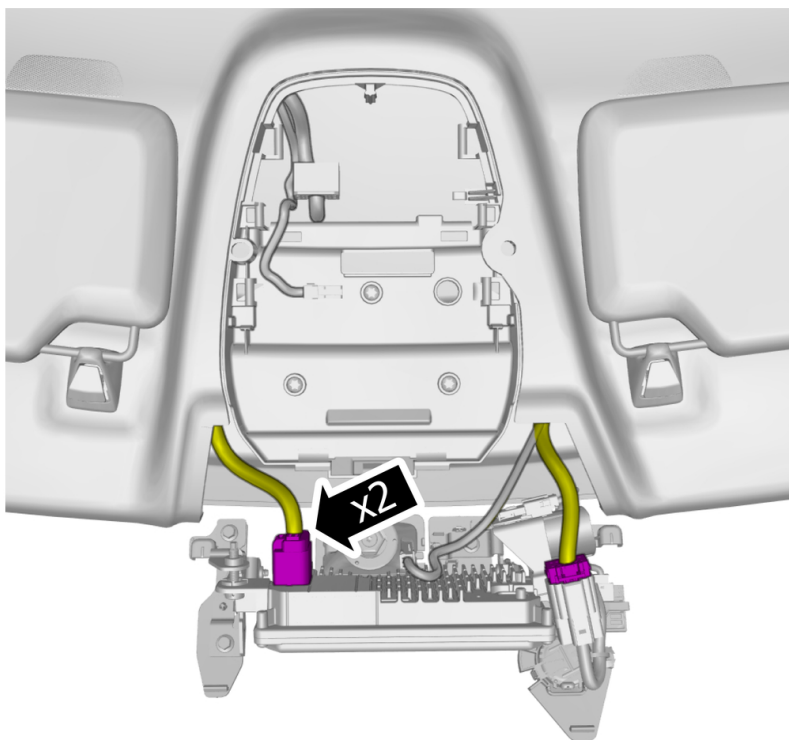

Disconnect the connectors.

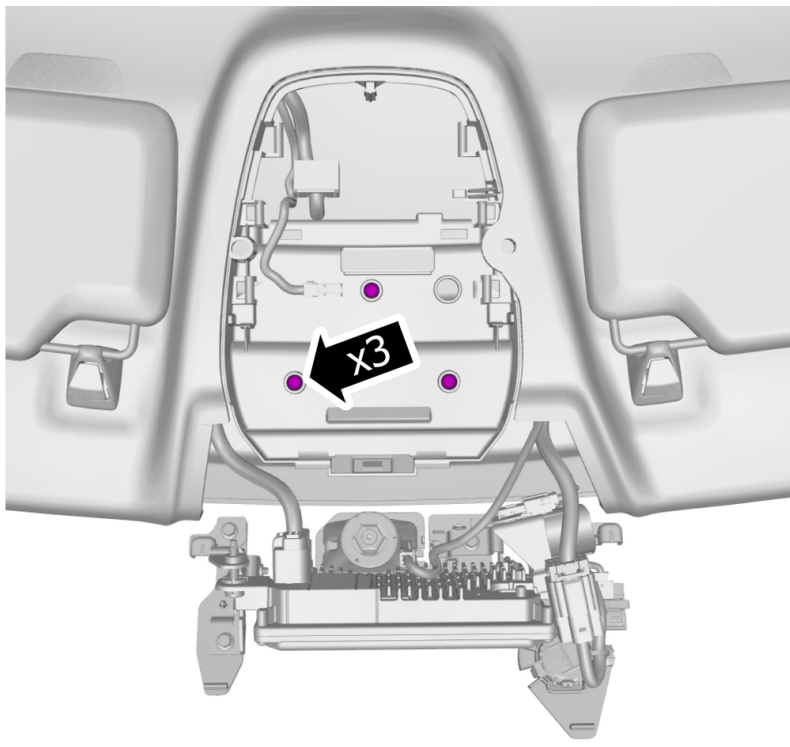

Remove the screws.

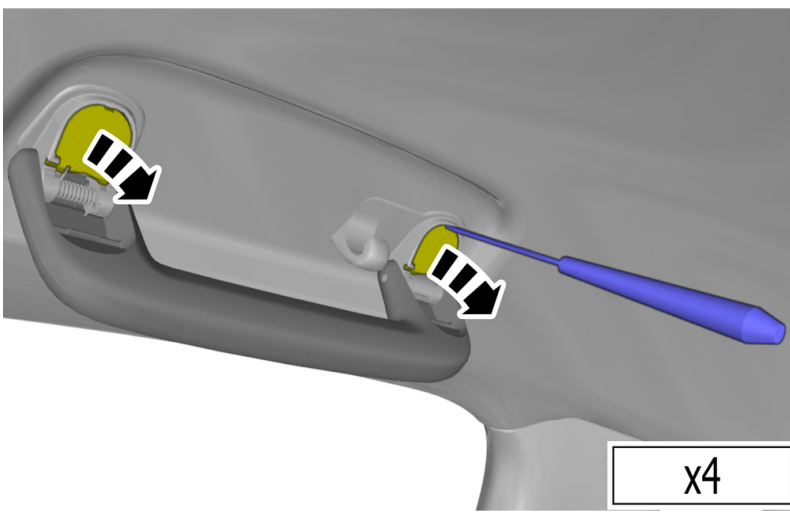

On both sides.

Use: Electrician's screwdriver

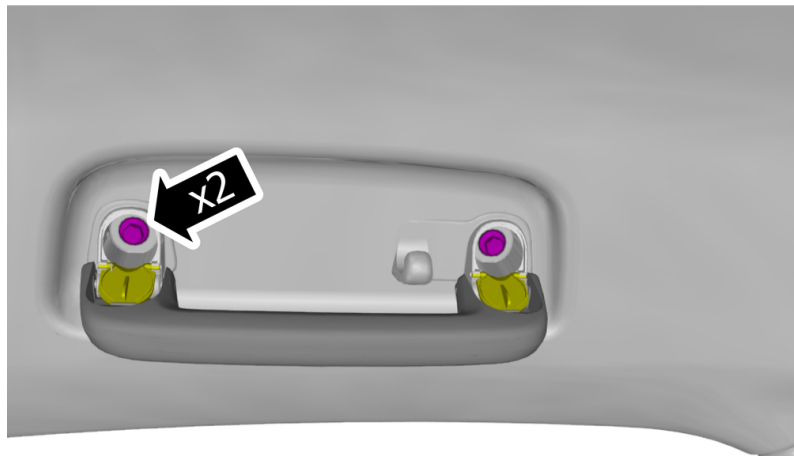

x4

Remove the screws.
On both sides.

Torque:
M6 , 10 Nm

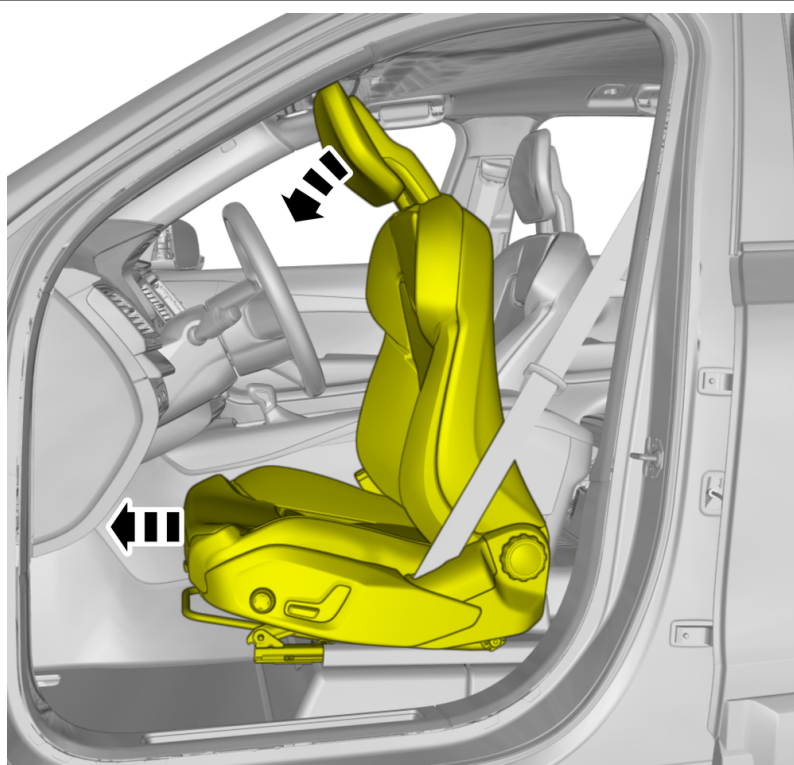

On both sides.

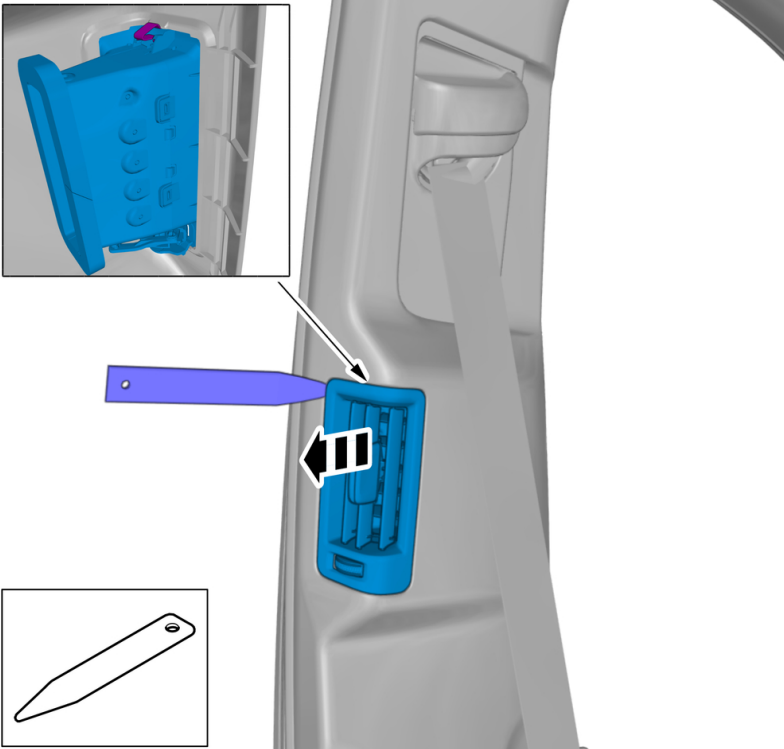

Remove the marked part.
On both sides.

Use: Interior trim remover

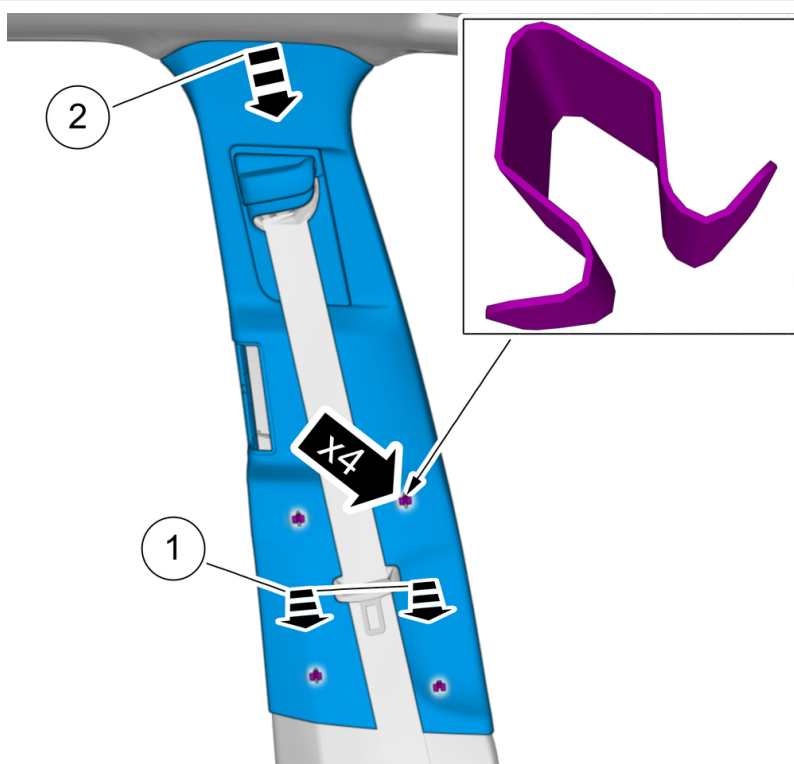

Remove the panel.
On both sides.

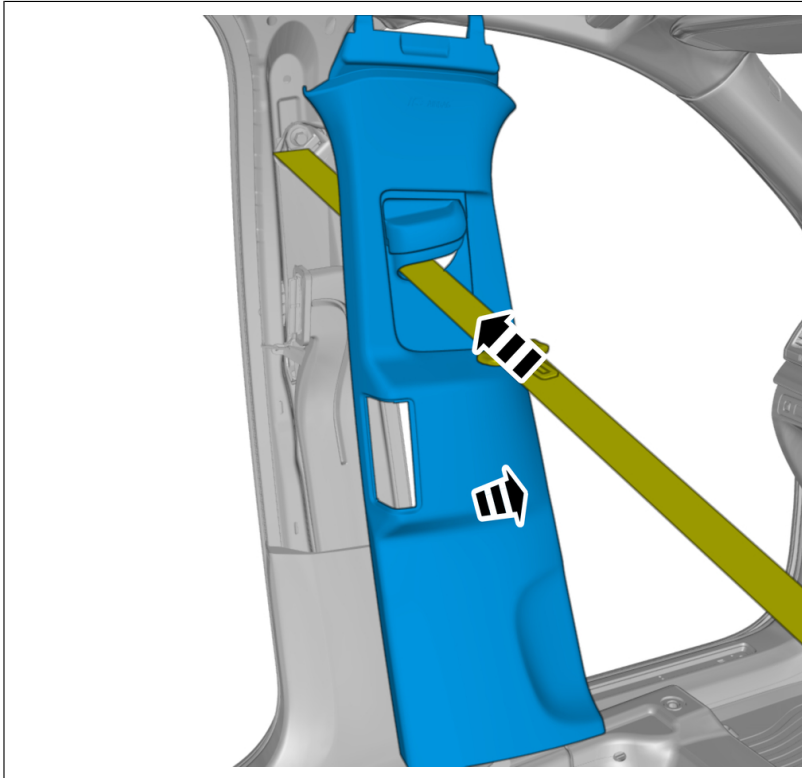

Fold marked part to one side.
On both sides.

Remove the D-pillar trim panel , refer to:
Removal, replacement and installation
8 - Body and interior
85 - Interior
851 - upholstery for wall/door, side, rear
shelf, luggage rack

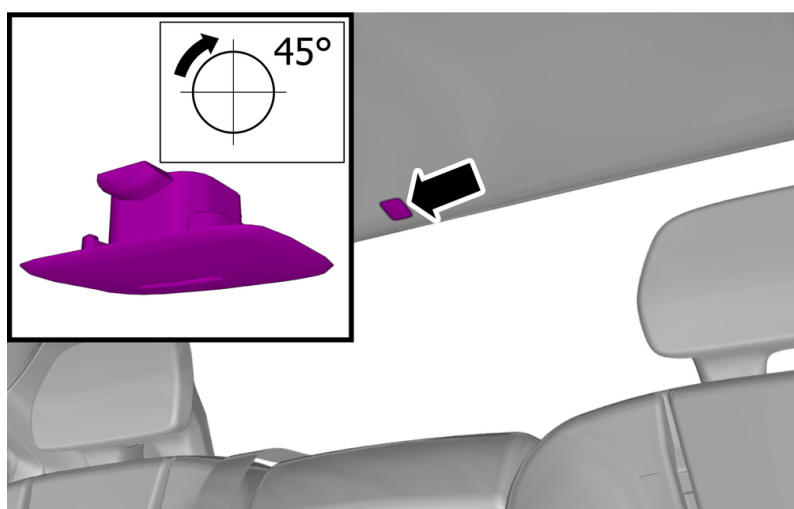

Remove the fastener.

Vehicles with roof opening panel

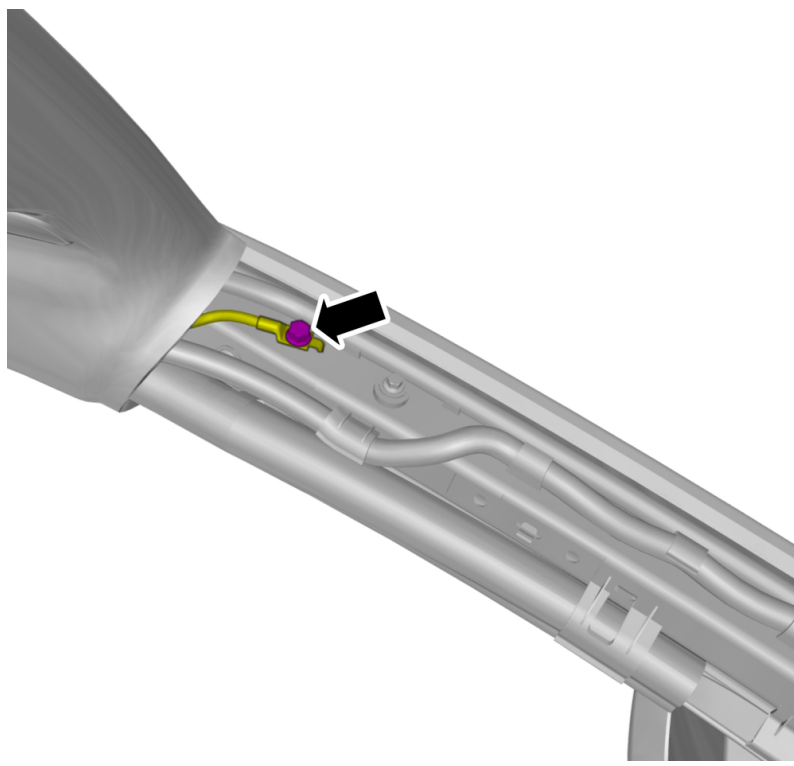

Remove the screws.

Torque:

M6 , 10 Nm



Caution! Take extra care not to crease the headliner.

Note! The graphic shows the back of the component before removal.

Note! Velcro strip

Use: Interior trim remover

Vehicles without roof opening panel



Caution! Take extra care not to crease the headliner.

Note! The graphic shows the back of the component before removal.

Note! Velcro strip

Use: Interior trim remover

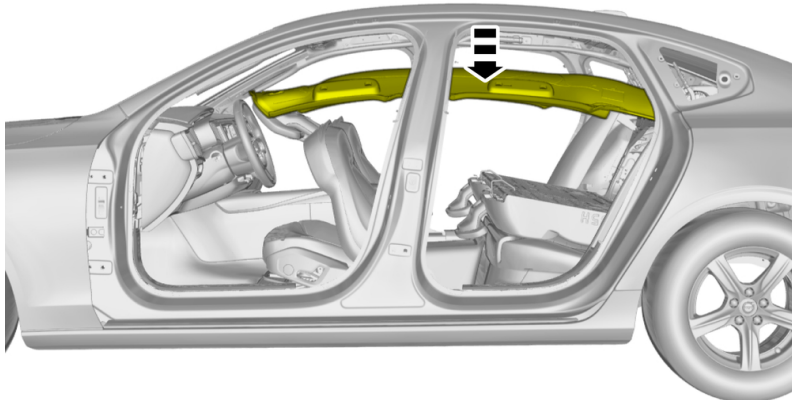

Caution! Take extra care not to crease the headliner.

Hint: This step may require the aid of another technician.

Remove the part carefully
Lower to suitable height.

Check

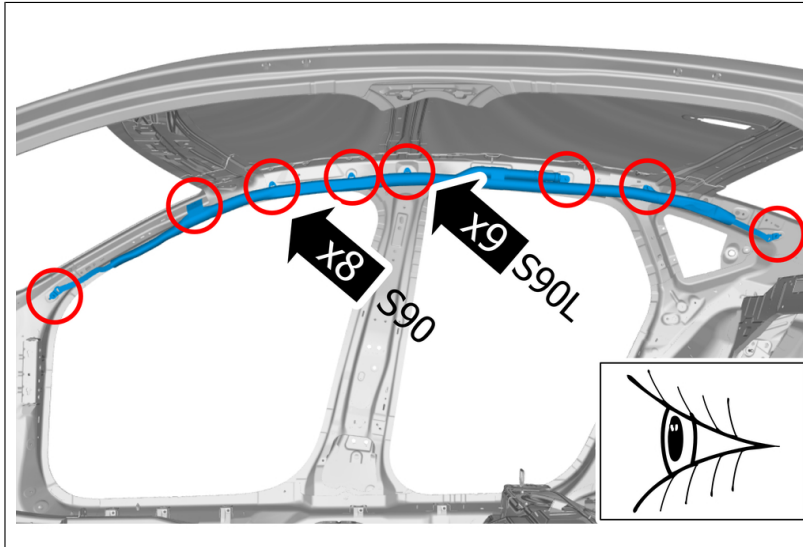

Note! Orientation view

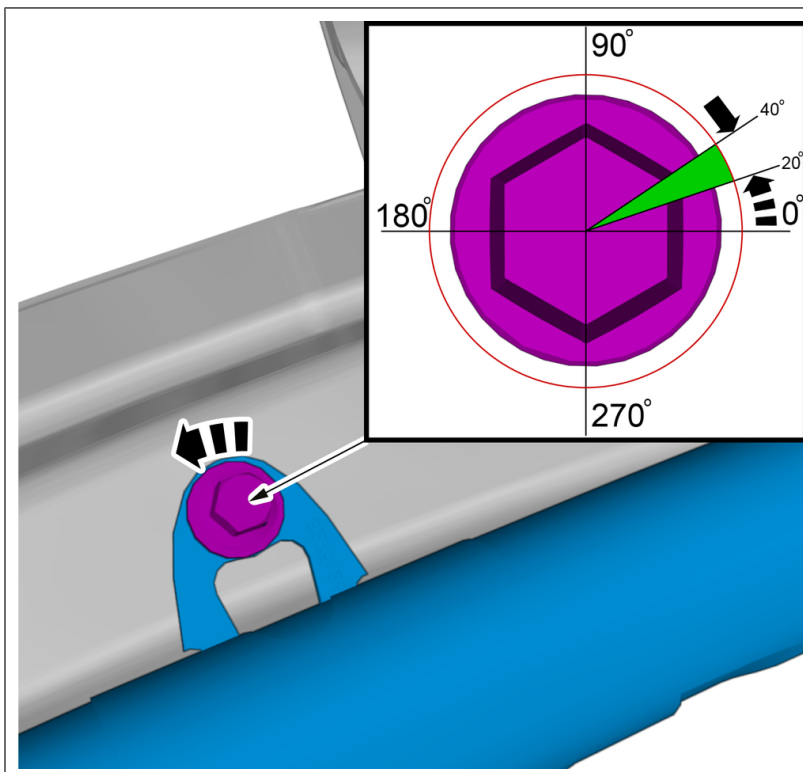

Warning! Loosen the screw between 20-40 degrees.

Warning! Do not re-tighten the screw after it has been loosened 20-40 degrees!

Note! Repeat the steps with the other marked screws.

On both sides.

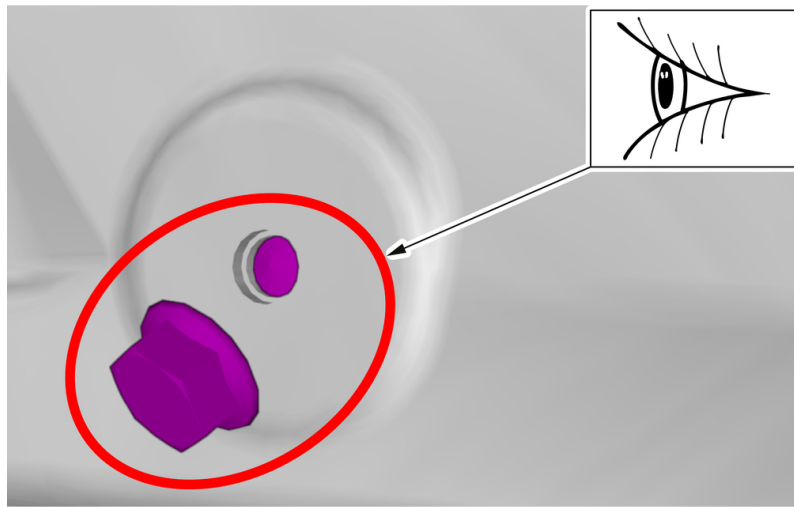

If the result of the checking procedure is not OK, the broken bolt must be replaced with a new bolt.

If no faults are detected, to install, reverse the removal procedure.

Installation

To install, reverse the removal procedure.

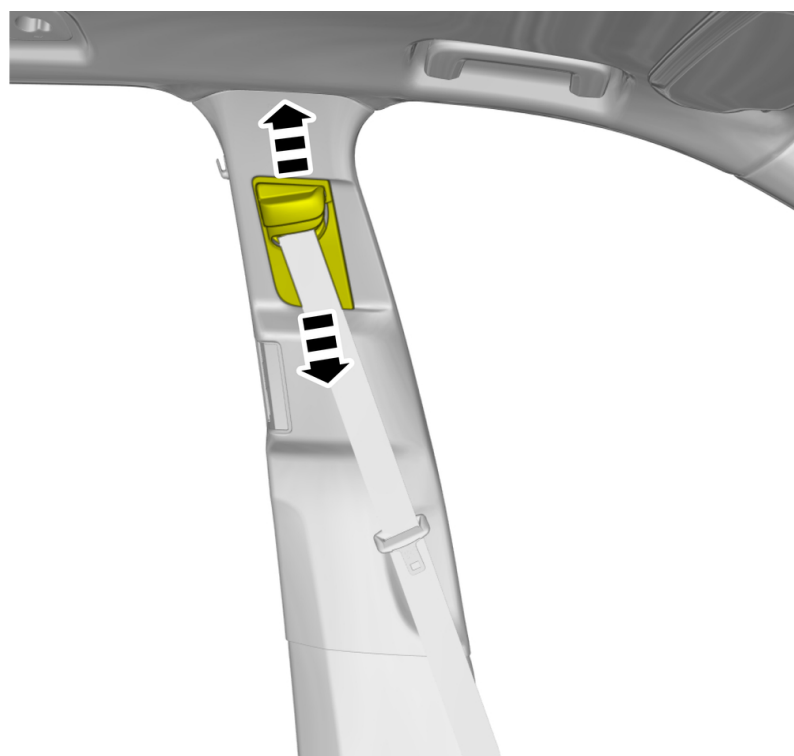

Check for correct operation.
On both sides.