

September 4, 2019

Version 4

## Safety Recall: Front Passenger's Airbag Inflator Can Be Over-Pressurized (Phase 2)

Supersedes 17-001, Dated December 7, 2018 to revise the information highlighted in **yellow**.

*Following NHTSA direction, there are five phases based on three different zones.*

*If the iN VIN status inquiry directs you to do this campaign, follow the applicable procedure regardless of where the vehicle is currently located because it may have moved between different states. Make sure you file a claim using the correct warranty claim information to avoid your claim being rejected.*

### AFFECTED VEHICLES

#### Zone A

Year	Model	Trim	VIN Range
2005-06	MDX	ALL	Check the iN VIN status for eligibility
2005-12	RL	ALL	Check the iN VIN status for eligibility

Zone A applies to model years 2005 through 2012 vehicles, that are located **or ever registered in**: Alabama, California, Florida, Georgia, Hawaii, Louisiana, Mississippi, South Carolina, Texas, Puerto Rico, American Samoa, Guam, the Northern Mariana Islands (Saipan), and the U.S. Virgin Islands.

#### Zone B

Year	Model	Trim	VIN Range
2005-06	MDX	ALL	Check the iN VIN status for eligibility
2005-09	RL	ALL	Check the iN VIN status for eligibility

Zone B applies to model years 2005 through 2009 vehicles, that are located or ever registered in: Arizona, Arkansas, Delaware, District of Columbia, Illinois, Indiana, Kansas, Kentucky, Maryland, Missouri, Nebraska, Nevada, New Jersey, New Mexico, North Carolina, Ohio, Oklahoma, Pennsylvania, Tennessee, Virginia, and West Virginia.

#### Zone C

Year	Model	Trim	VIN Range
2005-06	MDX	ALL	Check the iN VIN status for eligibility
2005-08	RL	ALL	Check the iN VIN status for eligibility

Zone C applies to model years 2005 through 2008 vehicles, that are located: Alaska, Colorado, Connecticut, Idaho, Iowa, Maine, Massachusetts, Michigan, Minnesota, Montana, New Hampshire, New York, North Dakota, Oregon, Rhode Island, South Dakota, Utah, Vermont, Washington, Wisconsin, and Wyoming.

**CLIENT INFORMATION:** The information in this bulletin is intended for use only by skilled technicians who have the proper tools, equipment, and training to correctly and safely maintain your vehicle. These procedures should not be attempted by "do-it-yourselfers," and you should not assume this bulletin applies to your vehicle, or that your vehicle has the condition described. To determine whether this information applies, contact an authorized Acura automobile dealer.

## REVISION SUMMARY

Under BACKGROUND and REPAIR PROCEDURE, the V-SMART tool was added.

## BACKGROUND

NHTSA and its independent expert reviewed the findings of three independent investigations into the Takata air bag inflator ruptures. According to NHTSA, the combination of time, high temperature fluctuations, and humidity contribute to the degradation of the propellant in the inflators. NHTSA has concluded that this degradation can cause the propellant to burn too quickly, creating more pressure than the inflator can withstand, and, in extreme cases, causing the inflator to rupture and send shrapnel through the air bag toward vehicle occupants. NHTSA is prioritizing the recall of air bag inflators based on the risk of injury or death to vehicle occupants.

Currently there are five planned phases to this campaign. The subsequent phases will launch at a future date per NHTSA direction, but it will be several years before the final phase launches. Additionally, AHM may add new affected models or affected years to each phase. Always do an iN VIN status inquiry to see if a vehicle is affected.

In early September 2019, the V-SMART tool was shipped to your dealership. This tool is used to help validate the installation of the front passenger's airbag replacement inflator. **Beginning September 30, 2019**, V-SMART will be a required tool for the installation of the front passenger's airbag replacement inflator. V-SMART validation for each of these repairs will be required for any and all warranty claims to be paid for such repairs. Refer to the job aid *Using V-SMART* and the *Tech2Tech*® video "Using V-SMART" for more information.

For more information about these inflator recalls, go to [www.safercar.gov](http://www.safercar.gov) and use keyword TAKATA.

### NOTE

**If the VIN status inquiry indicates that the vehicle is subject to any open safety recalls, including the driver's airbag inflator, make sure to also complete those recall repairs before returning the vehicle to the client. If you are unable to complete any open recall, advise the client of the recall status and when the recall could be completed.**

## CLIENT NOTIFICATION

Owners of affected vehicles will be sent a notification of this campaign.

Do an iN VIN status inquiry to make sure the vehicle is shown as eligible.

Some vehicles affected by this campaign may be in your used vehicle inventory.

Failure to repair a vehicle subject to a recall or campaign may subject your dealership to claims or lawsuits from the client or anyone else harmed as a result of such failure. To see if a vehicle in inventory is affected by this safety recall, do a VIN status inquiry before selling it.

## CORRECTIVE ACTION

Replace the passenger's airbag inflator, then return the original, undeployed inflator as directed.

## PARTS INFORMATION

Part Name	Order Part Number	You may receive any of the following	Quantity
2005–06 MDX Front Passenger’s Airbag Inflator Kit	04790-S3V-315	04790-S3V-A00 04790-S3V-315 04790-S3V-305 (this inflator is no longer produced, but if you have one in stock, it may be installed in a vehicle)	1
2005–12 RL Front Passenger’s Airbag Inflator Kit	04790-SJA-315	04790-SJA-A00 04790-SJA-315 04790-SJA-305 (this inflator is no longer produced, but if you have one in stock, it may be installed in a vehicle)	1

### NOTES

- Replacement inflators with P/Ns that end with 305 come with shipping insulation wrapped around them. Follow the removal instructions listed in INSULATION REMOVAL. The insulation is not toxic but some people may be sensitive to it.
- Replacement part numbers ending in 315 and A00 are similar to the ones with plastic caps at the end but the plastic caps have square openings.
- The inflator kit box must be used to return the recalled inflator to its supplier. Be careful not to damage the inflator kit box.
- If the recalled, undeployed inflator is not returned, the warranty claim for that vehicle will be charged back to your dealership.
- To return the undeployed inflators, follow the shipping instructions outlined in PIB B15-0006.
- Parts staff can scan the part number and serial number from the outside of the box into the warranty claim by using the Controlled Part Serial No. screen and scanning the applicable information. Refer to the Job Aid **Ordering and Managing Replacement Inflators** for more information.

## WARRANTY CLAIM INFORMATION

### NOTES

- Process claims as quickly as possible so that resources can be properly allocated.
- Enter the part number of the inflator that you received into the warranty claim, not the part number that you ordered. For more information, refer to step 6 of REPAIR PROCEDURE.
- To avoid non-payment of warranty claims, the serial number of the new airbag inflator must be entered in the warranty claim. For more information, refer to step 6 of REPAIR PROCEDURE.
- To avoid a warranty claim being charged back to your dealership, you must return the original, undeployed inflator to its supplier. Follow the shipping instructions outlined in PIB B15-0006, *Inflator Kit Return Process*.
- The serial number is encoded into the bar code printed on the label inside of the box and on a label attached to the outside of the box. If your dealership uses a scanner, you can scan the serial number from either place into the claim.

- The part number is encoded into a barcode attached to the outside of the box. If your dealership uses a scanner, you can scan the part number into the claim.
- If you confuse the serial number and part number when entering the claim information, your claim will automatically be rejected.
- For more information about scanning and filing airbag inflator recall claims, refer to **Ordering and Managing Replacement Inflators**. From the iN, select **Service, Warranty, Warranty Claim**, then **Reference Guide**. Under **HOT TIPS/TOPICS**, select **Inflator Claims at a Glance**.
- Each VIN is assigned to a specific campaign. Make sure you file a claim using the correct warranty claim information to avoid your claim being rejected.

**Replacing the front passenger’s airbag inflator**

Year/Model	Operation Number	Replacement Part Number	Flat Rate Time	Defect Code	Symptom Code	Template ID	Failed Part Number
2005–06 MDX	7540A2	04790-S3V-305	0.7 hr	6DB00	KE000	B17001A	06780-S3V-A10ZA
		04790-S3V-315	0.7 hr			B17001B	
		04790-S3V-A00	0.7 hr			B17001C	
2005–12 RL	7540A2	04790-SJA-305	0.8 hr	6DB00	KE000	B17001D	06780-SJA-A80
		04790-SJA-315	0.8 hr			B17001E	
		04790-SJA-A00	0.8 hr			B17001F	

Skill Level: Repair Technician

**IDENTIFYING COUNTERFEIT AIRBAGS**

This section goes over the steps to identify counterfeit airbags and applies to all vehicles in this service bulletin. It is referred to in each vehicle’s repair procedure. Click [HERE](#) to watch a video to help identify counterfeit airbags.

- If there is nothing unusual about the airbag or the inflator, continue with the inflator replacement procedure.
- If there are any unusual markings, like an incorrect label or a model year written in marker, the airbag and inflator may not be the correct airbag and/or inflator for the vehicle or it may be a counterfeit part. For more information about counterfeit airbags, you can refer to [safercar.gov](http://safercar.gov), enter keywords **MANAGING COUNTERFEIT**, and select **Recommended Dealer Guidance for Managing Counterfeit Air Bags** from the list. **If you suspect that the airbag or inflator is counterfeit, do not continue this procedure.** Contact your DPSM for assistance

NON-STANDARD SAFETY LABEL

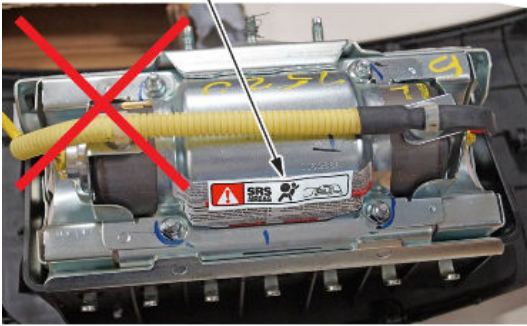

GREASE PENCIL OR PAINT MARKINGS

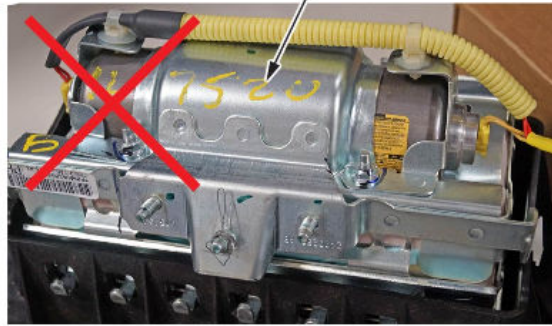

HAND ENGRAVING



NO LABELS ON INFLATOR

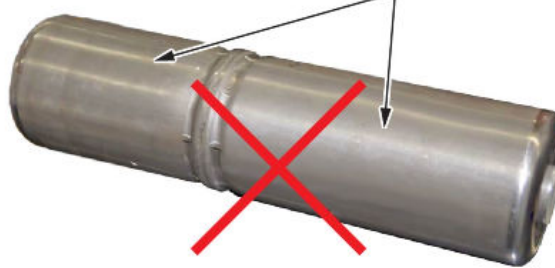

## REPAIR PROCEDURE

### NOTES

- If the VIN status inquiry indicates that the vehicle is subject to any open safety recalls, including the driver's airbag inflator, make sure to also complete those recall repairs before returning the vehicle to the client. If you are unable to complete any open recall, advise the client of the recall status and when the recall could be completed.
  - Make sure you have the anti-theft code for the audio and navigation system (if applicable), then write down the frequencies for the radio's preset buttons.
  - Be careful not to damage any parts when replacing the inflator, and **follow the procedure exactly**.
  - If, before removing the airbag, you suspect that it may be the incorrect airbag for the vehicle or a counterfeit, **do not remove the airbag**. Contact your DPSM for assistance.
  - Make sure you have reviewed the SRS Precautions and Procedures in the service information before doing the REPAIR PROCEDURE.
1. Turn the ignition switch to the ON (II) position and check if the SRS indicator comes on for about 6 seconds, then turns off.
    - If the indicator comes on, then turns off after about 6 seconds, go to step 2.
    - If the indicator does not come on, or if it stays on, contact your DPSM for assistance.
  2. Disconnect the battery negative cable and wait at least 3 minutes before continuing.
  3. Remove the front passenger's airbag. Refer to the applicable vehicle's service information.

- Place the airbag, face-down, on a clean shop towel.

#### NOTES

- The orientation of the airbag is critical because if the inflator is installed incorrectly, the harness will be too short when you reinstall the airbag.
- The brackets between the various models are similar but may differ from the example shown.

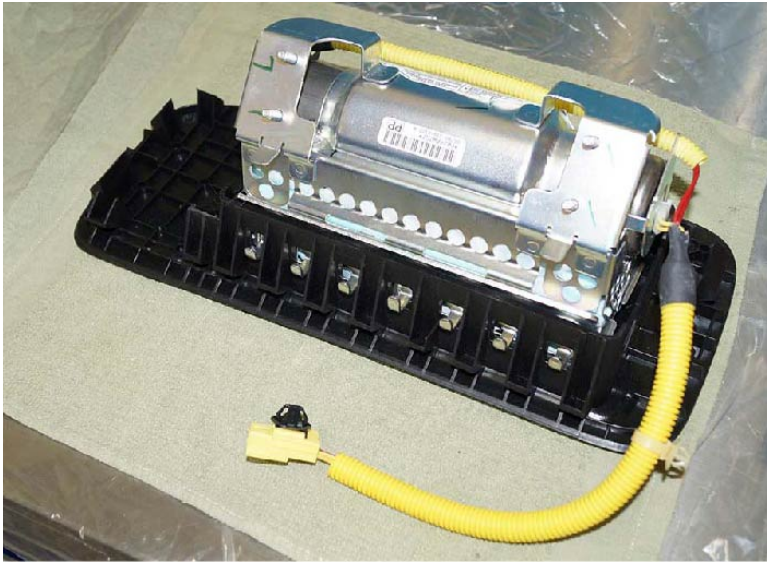

- Visually inspect the airbag and the inflator for any unusual writing or markings. Refer to IDENTIFYING COUNTERFEIT AIRBAGS.
- Peel the label located inside the inflator box from its backing and attach it to the RO. For the warranty claim to be paid, the **replacement inflator part number that you received** must be included in the warranty claim.

#### NOTES

- The replacement part number is printed on the top part of the label and the serial number is printed on the bottom. **Make sure you attach the label to the RO and give it to the warranty clerk .**
- There may also be a colored sticker located in the kit, ignore it because it is not used.
- Not all inflator kits have a label included. In those cases, write the serial number and part number from the side of the inflator box on the RO. The part number always starts with 047.

#### PASSENGER INFLATOR PARTS BOX

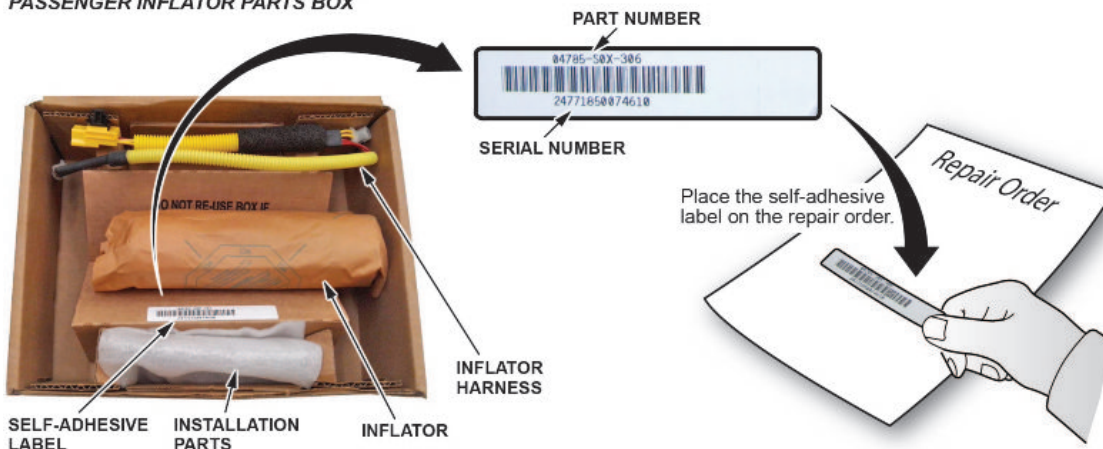

7. Remove the harness from both ends of the inflator bracket.

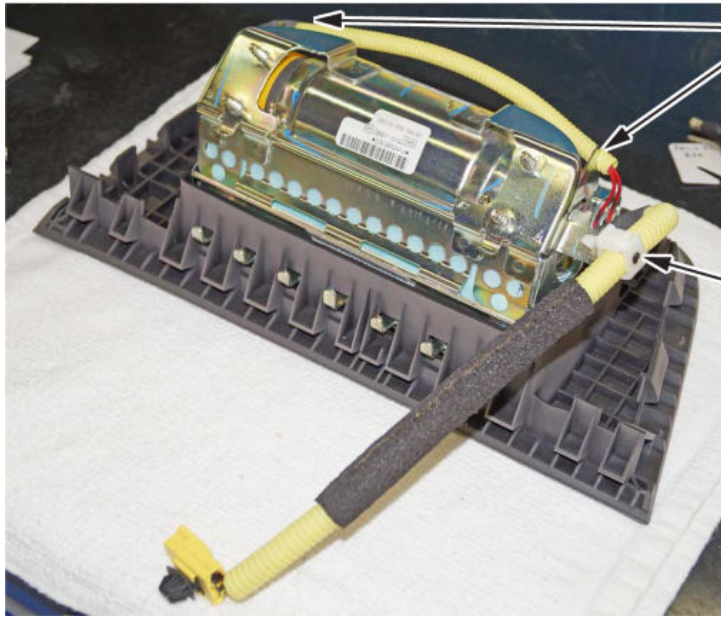

**INFLATOR BRACKETS**

Disconnect and remove the harness clip if applicable.

8. Short the red wires.

**NOTE**

**You must cut and short the wires** as indicated to prevent accidental deployment.

8.1. Cut the red wires as shown.

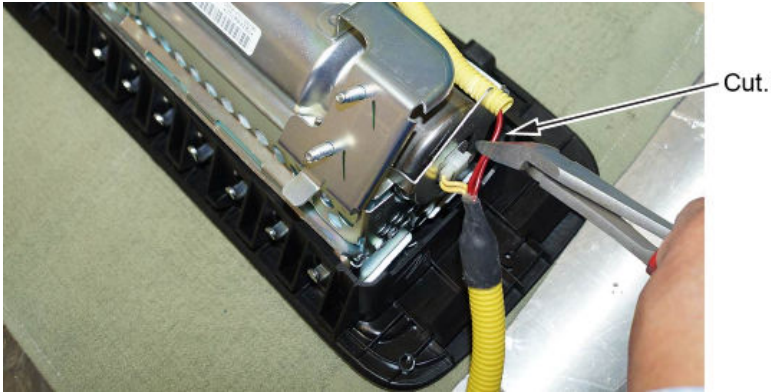

8.2. Cut about 2 inches of the corrugated tube, then pull out the two red wires.

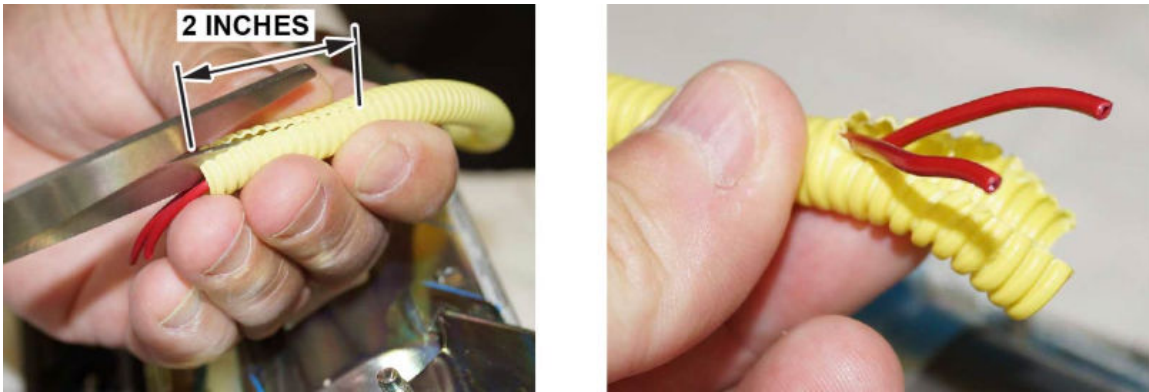

8.3. Strip away about 1 inch of the wire insulation, then twist the wires together.

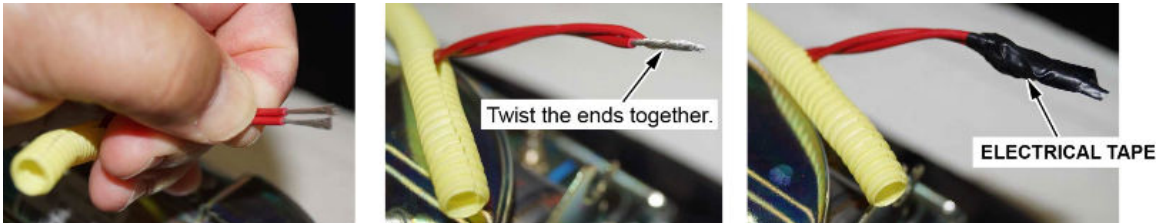

8.4. Tape the twisted ends with electrical tape.

9. Cut off the connector and short the yellow wires.

**You must cut and short the wires as indicated** to prevent accidental deployment.

9.1. Cut all four wires to remove the connector.

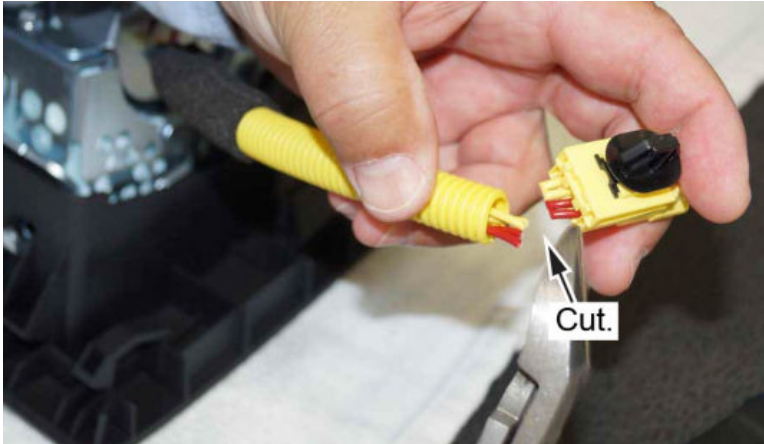

9.2. Cut about 2 inches of the corrugated tube, then pull out the yellow wires.

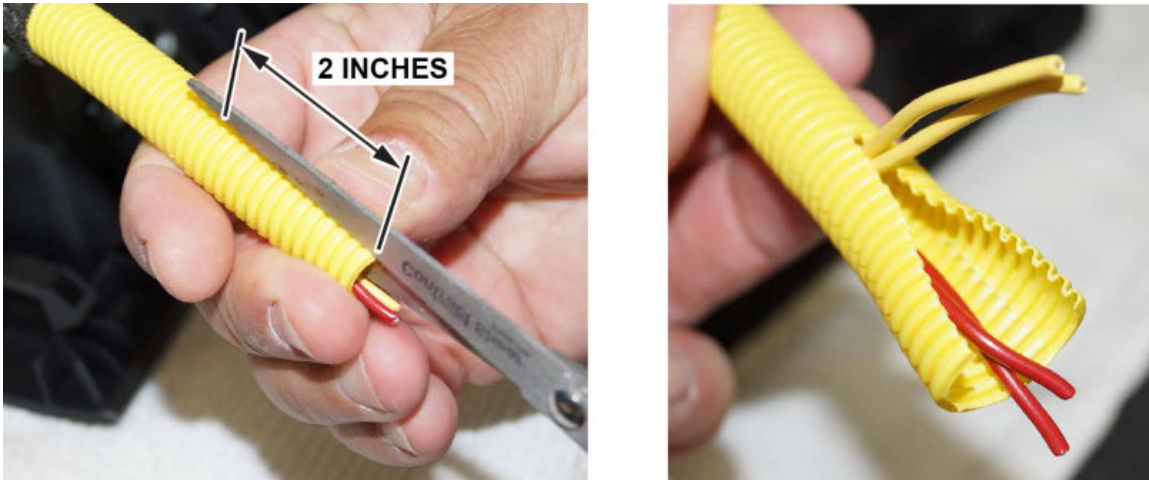

9.3. Strip away about an inch of the wire insulation, then twist the wires together.

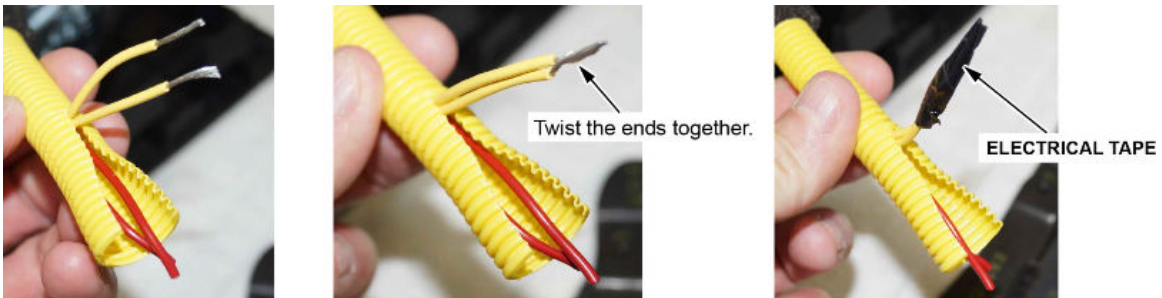

9.4. Tape the twisted ends with electrical tape.

10. Remove the four inflator nuts.

### INFLATOR NUTS

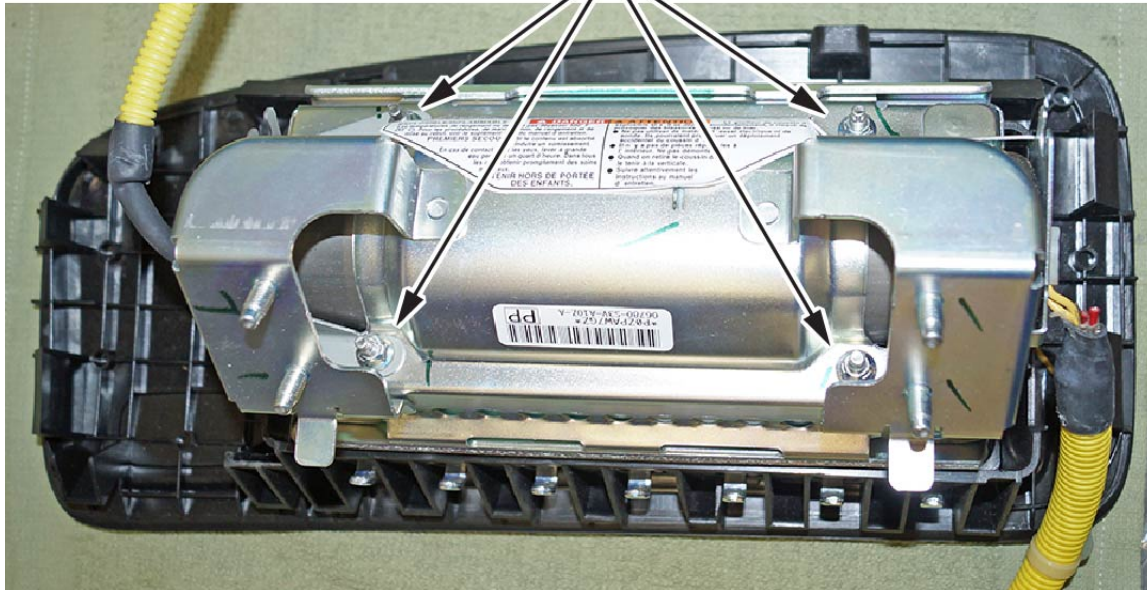

11. Remove the inflator bracket.

#### NOTE

You can only remove one of the brackets, as the other is welded to the airbag housing.

### INFLATOR BRACKET

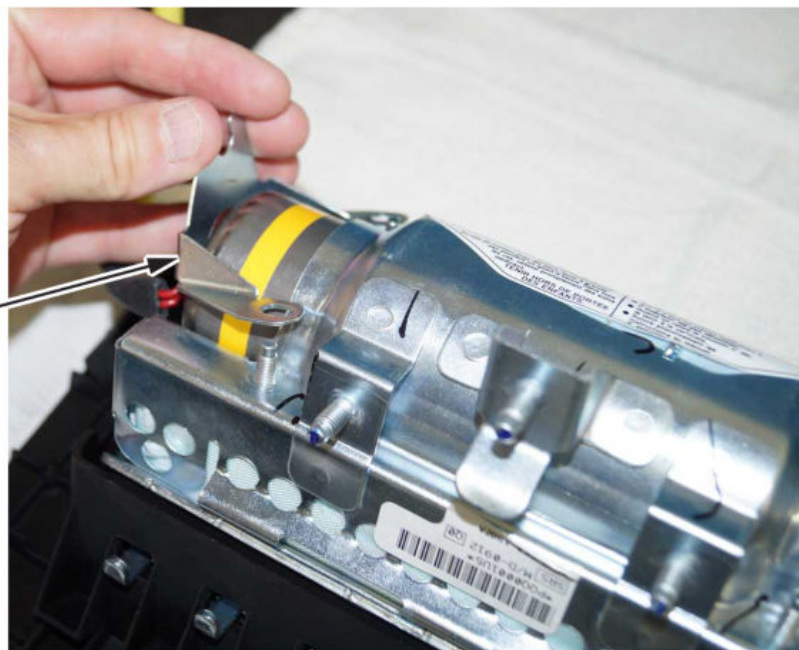

12. Remove the inflator by pushing it out.

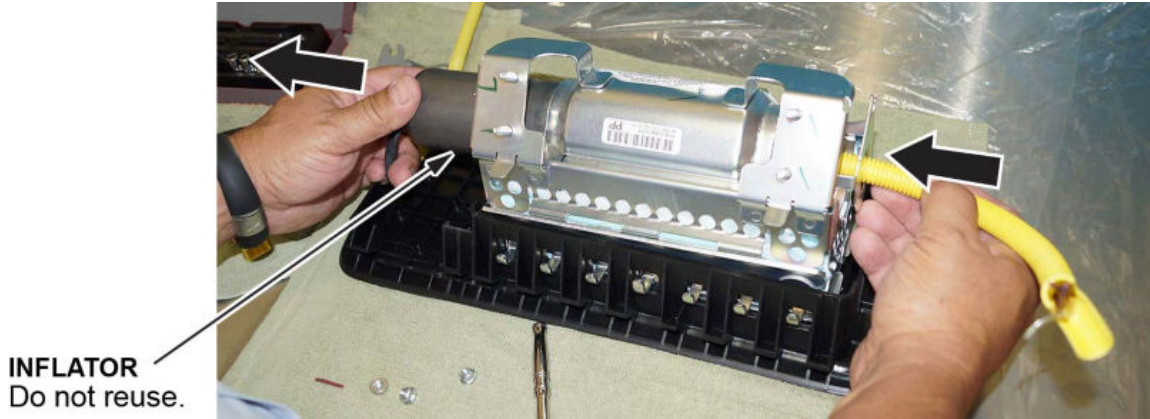

13. Install the new inflator.

**NOTE**

There may be some minor surface rust or corrosion on the new inflator; this is OK.

Click [HERE](#) for a short video about the different variations of the driver's and front passenger's replacement inflators involved with the recalls related to inflators. While both the driver's and front passenger's inflators are shown in the video, this is informational only. Replace inflators only as directed by the iN VIN status inquiry.

13.1. **Check your part number against the ones listed for each installation procedure. Use the correct installation procedure for the part you received.**

**NOTES**

- If the inflator is wrapped in an insulated sleeve, go to INSULATION REMOVAL for instructions to remove it.
- Part numbers ending in 315 and A00 appear slightly different because they have square openings in the plastic caps.

**Part Number**

- 04790-S3V-305
- 04790-S3V-315
- 04790-S3V-A00
- 04790-SJA-305
- 04790-SJA-315
- 04790-SJA-A00

13.2. Collars on this inflator are orange. One side of the inflator has a longer collar, a tab, a plastic cutout, and a small flat spot on the connector. The other side of the inflator has a shorter collar, no tab, and a red dot. Make sure you insert the end with the longer collar into the airbag first.

#### NOTES

- The V-SMART tool can only validate inflators with slotted end caps. You may receive an inflator with solid end caps. This is the correct part to repair the vehicle, but the V-SMART will fail the validation. **The V-SMART validation must fail a total of three times** before you can have your supervisor override the validation using the **Supervisor Inspection Override**.
- Your supervisor can be a service manager, shop foreman, team leader, etc. **The supervisor must inspect your work** to make sure the replacement inflator was installed correctly. When a supervisor enters his or her information, **the supervisor is signing off that the technician's work was inspected and approved**.

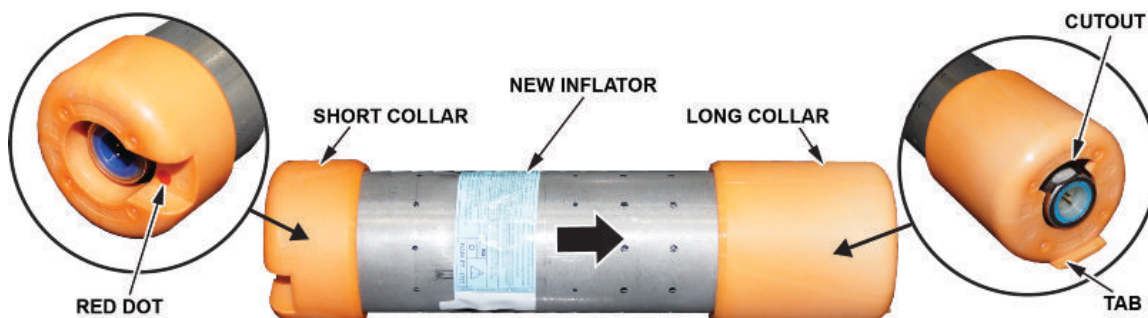

(Some part numbers have solid collars [above] and some part numbers have collars with slots [below])

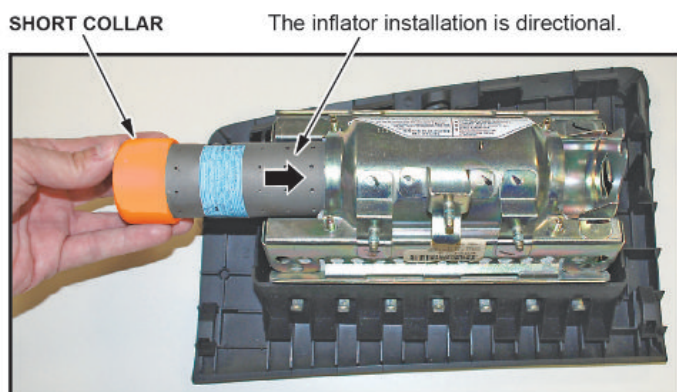
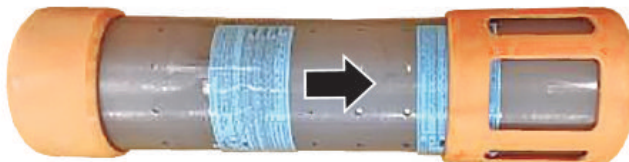

13.3. Slide the inflator in until the plastic cutout and the small flat spot align with the tab on the bracket. There should be no space or gap between the inflator and bracket.

**FIXED BRACKET END**

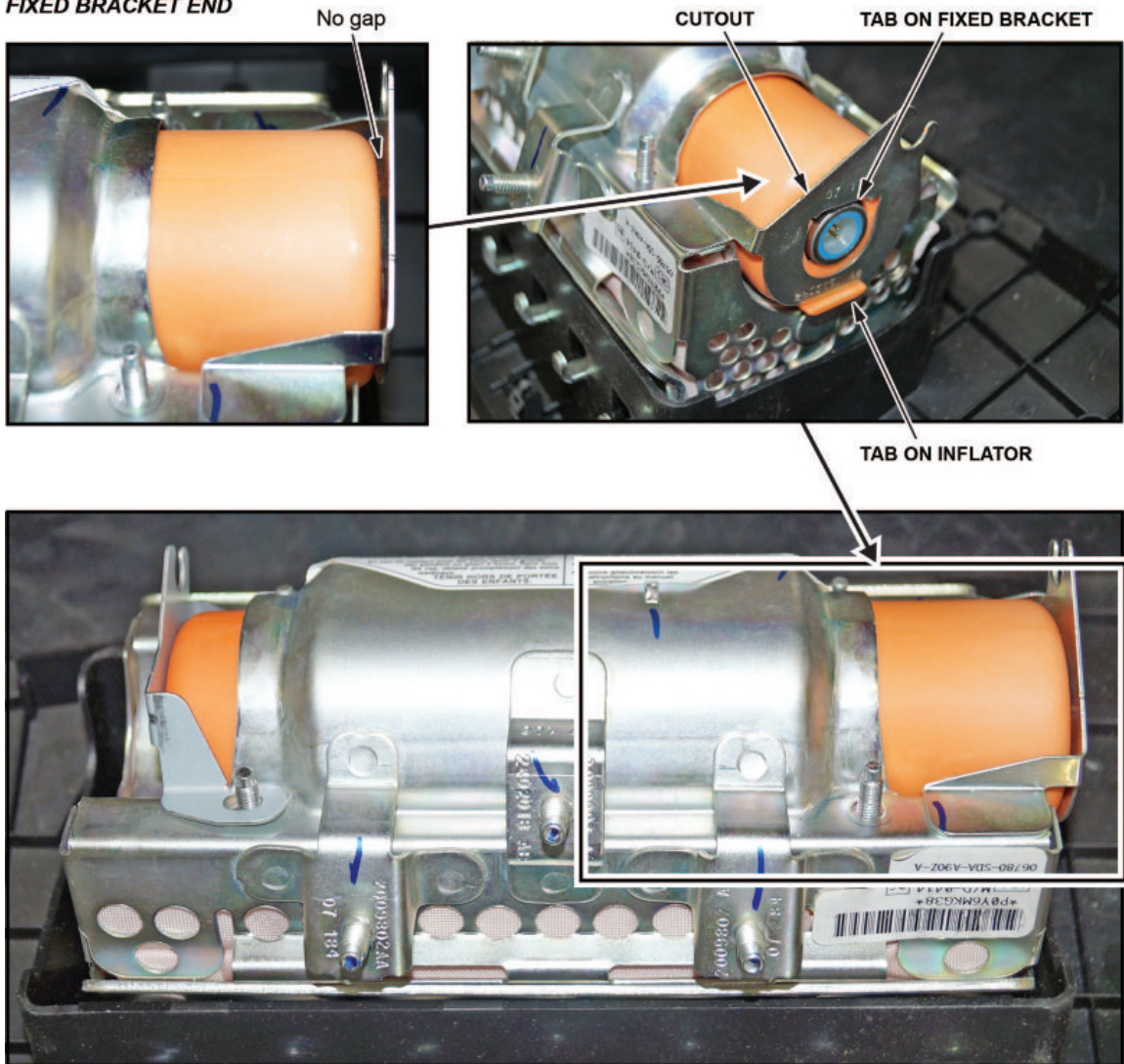

13.4. Install the bracket included in the kit onto the airbag module. There should be a red dot visible on the end of the plastic connector. There should be no space or gap between the inflator and bracket.

**ADJUSTABLE  
BRACKET END**

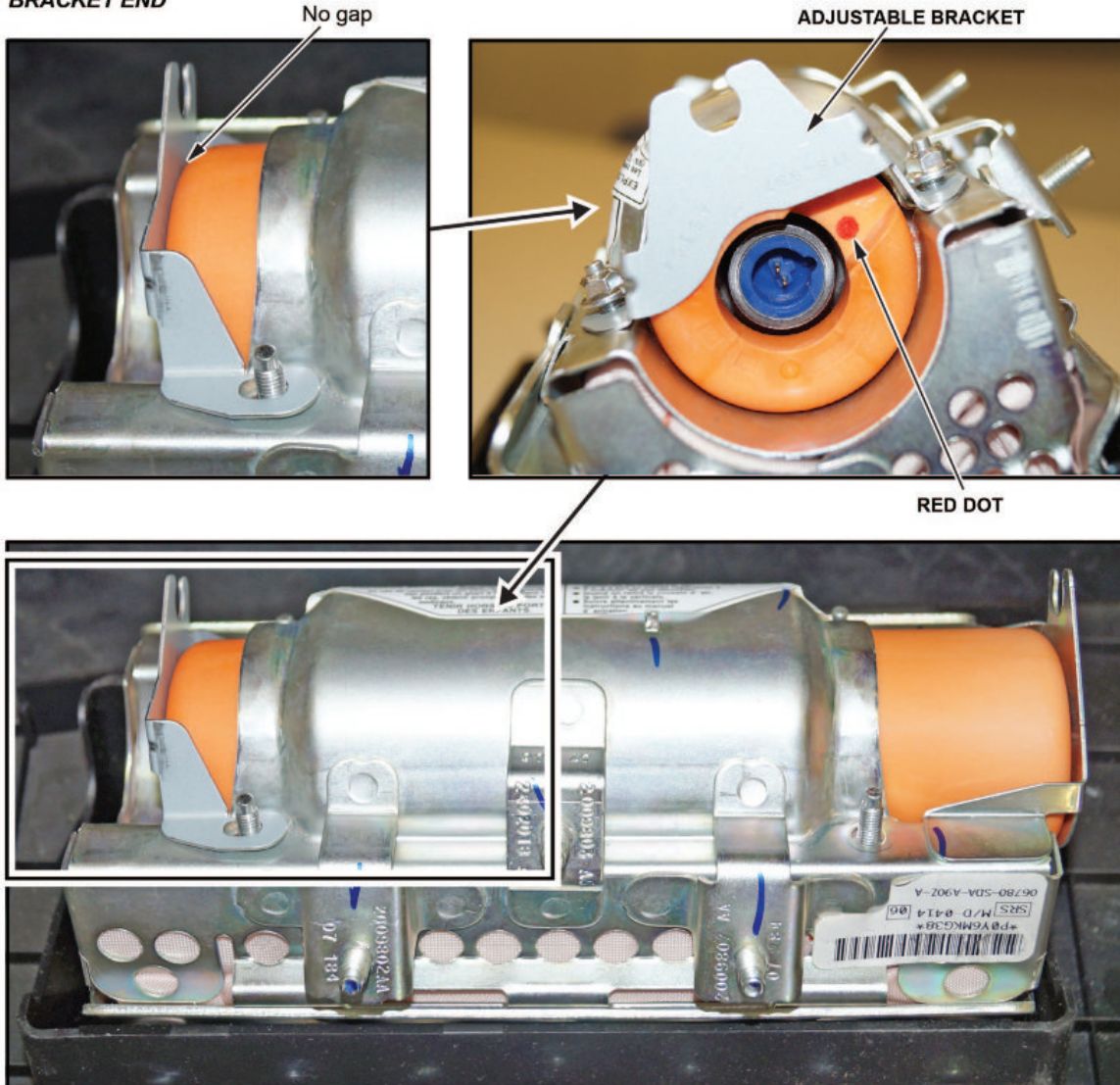

14. Install the new 5 mm locknuts and torque them in sequence to **3.9 N•m (34 lb-in)** .

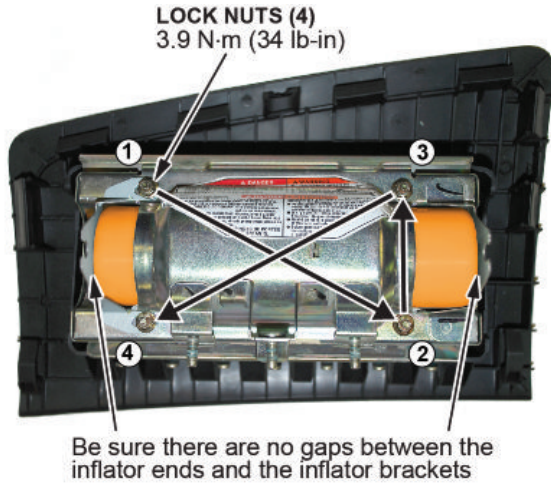

15. Remove the stickers covering the terminals on both sides of the new inflator.

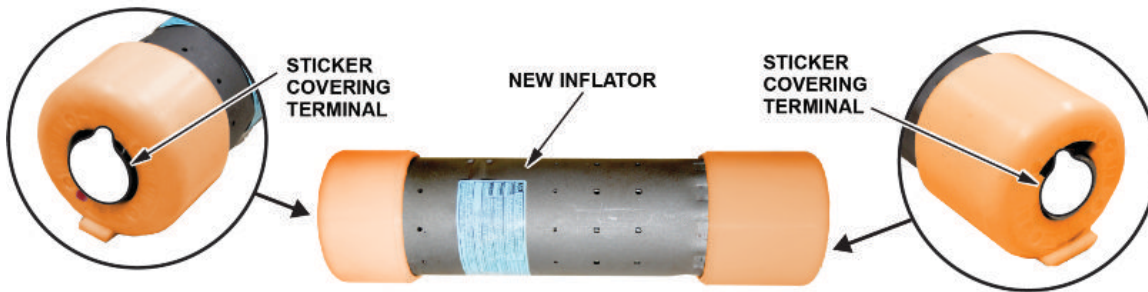

16. Using the V-SMART tool, validate that the airbag replacement inflator is installed correctly.

#### NOTES

- You must validate the front passenger's airbag replacement inflator installation using the V-SMART tool **before** connecting the inflator harness.
- Your warranty claim will not be paid if the V-SMART validation is not completed or the photo is not sent. Make sure you see the **Uploaded Completed** message to confirm the photo was sent to the warranty department.

17. Install the new inflator harness.

17.1. Make sure the airbag and harness are aligned as shown.

**NOTES**

- **Make sure you have the orientation correct as shown below.** If you connect the harness incorrectly, the harness cannot be removed, and you will not be able to reinstall the airbag because the harness will be too short.
- Connect the red wire connector to the connector with the red dot.



17.2. Connect the two connectors. Align the "T" shape in the inflator harness connector with the T-shaped inflator connector, then press the connector into place.

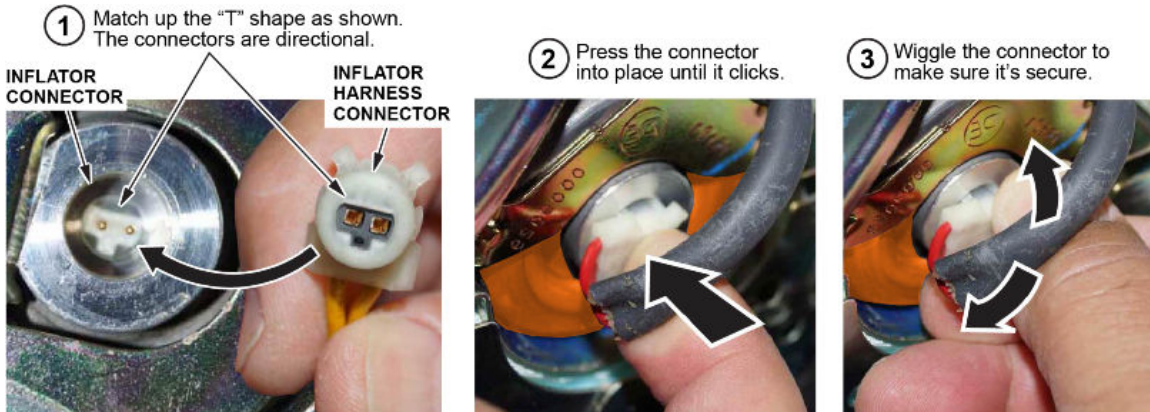

17.3. After you hear each connector click, wiggle it to make sure it is secure.

**NOTE**

If the connector is not properly aligned, it will come out.

18. Connect the harness to the inflator brackets.

18.1. Insert the side without the shrink wrap tubing first. Insert the harness at the third “valley” in the corrugated tube.

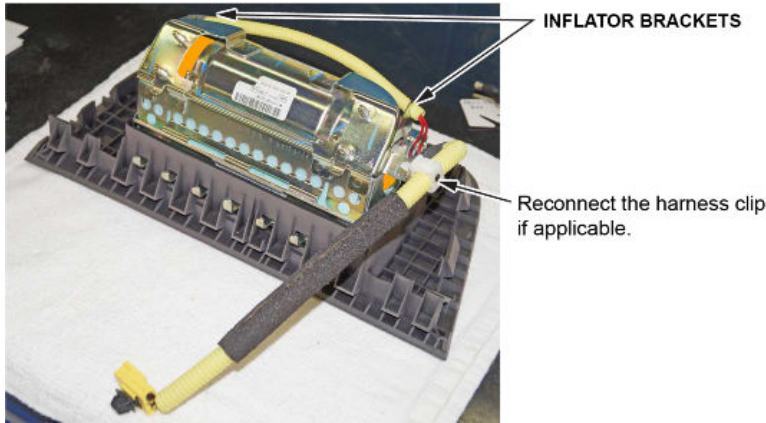

18.2. Insert the side of the harness with the shrink wrap tubing into the inflator bracket. Make sure the harness is securely inserted and that it does not sag.

19. Reinstall the passenger's airbag into the vehicle and torque the new locknuts to **9.8 N•m (7.2 lb-ft)** .

20. Reconnect the battery negative cable and enter the anti-theft code for the audio and navigation system (if applicable), then enter the audio presets.

21. Set the clock (for vehicles without navigation).

22. Turn the ignition to ON and make sure the SRS indicator comes on for about 6 seconds, then goes off.

23. Put the original inflator into the box the new one came in. Make sure there is no other hardware in the box because if the package rattles, it will not be accepted by the courier.

#### NOTE

If the new inflator came with an insulated sleeve, make sure you change the orientation of the cardboard insert so that the original inflator doesn't rattle. See INSULATION REMOVAL for more information.

24. Follow the shipping instructions outlined in PIB B15-0006 to return the undeployed inflator.

25. Give your warranty clerk the RO that includes the replacement inflator serial number and replacement part number. For the warranty claim to be paid, the **replacement inflator part number** must be included in the warranty claim.

## INSULATION REMOVAL

If the replacement inflator is wrapped with shipping insulation, remove it.

### NOTES

- Wear disposable gloves and protective glasses. The insulation is not toxic or dangerous, but some people may be sensitive to the insulation.
  - Dispose of the insulation and wrapping paper to avoid getting the insulation dust/fibers on you or the airbag assembly.
  - Do not reuse the insulation or wrapping paper. You do not need to wrap the inflator being removed from the vehicle when it is returned.
1. Cut the wires off from the opposite side from where they are tied (twisted) together.

### NOTE

Do not cut the insulation.



2. Hold the paper wrapping the inflator with one hand and slide the insulation off into the trash.

### NOTE

The insulation is securely wrapped around the inflator. You may have to use some force to slide the insulation off. Do not cut the insulation and be careful that you do not move the white or orange plastic ends.



3. Remove the wrapping paper and drop it into the trash.



4. To return the original inflator, remove the cardboard insert and turn it 90 degrees. Then insert the cardboard into the slots as shown.

#### NOTES

- **Do not reuse the shipping insulation.**
- The cardboard insert needs to be adjusted to send back the original inflator otherwise the original inflator removed from the vehicle will rattle around and may be rejected by the courier.

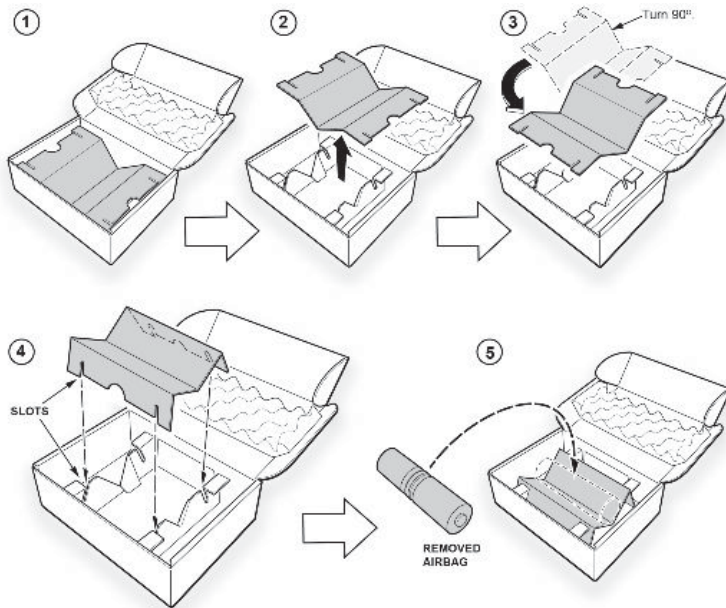

END