

A. VEHICLE INSPECTION PROCEDURE

1. Verify that the vehicle is within the following range:

Model Year	VIN Range	Build Date Range
2016	3MZBM****GM 256489 – 265511	September 24, 2015 through October 16, 2015

- If the vehicle is within the above range, proceed to Step 2.
 - If the vehicle is not within the above range, return vehicle to the customer or inventory.
2. Perform a Warranty Vehicle Inquiry using your eMDCS System and inspect vehicle for Campaign Labels **Recall 0216I** attached to the vehicle's hood or bulkhead. Refer to eMDCS System - Warranty Vehicle Inquiry Results table below.

NOTE: Be sure to verify Recall number as the vehicle may have multiple Recall labels.

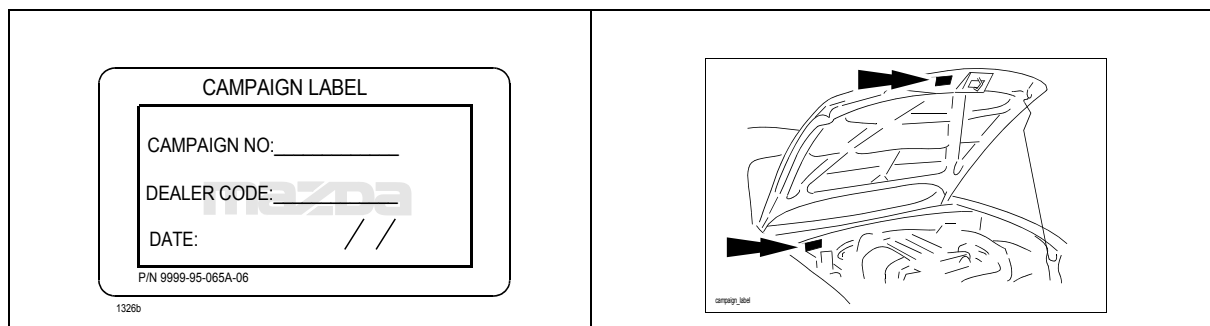

eMDCS System - Warranty Vehicle Inquiry Results:

If eMDCS displays:	Campaign Label is:	Action to perform:
RECALL 0216I OPEN	Present	Contact the Warranty Hotline at (877) 727-6626 option 3 to update vehicle history.
	Not present	Proceed to "B. INSPECTION PROCEDURE".
RECALL 0216I CLOSED	Present	Return vehicle to inventory or customer.
	Not present	Complete a label and apply to vehicle's hood or bulkhead.
RECALL 0216I is not displayed	Does not apply	Recall does not apply to this vehicle. Return vehicle to inventory or customer.

B. WORKFLOW OF INSPECTION AND REPAIR

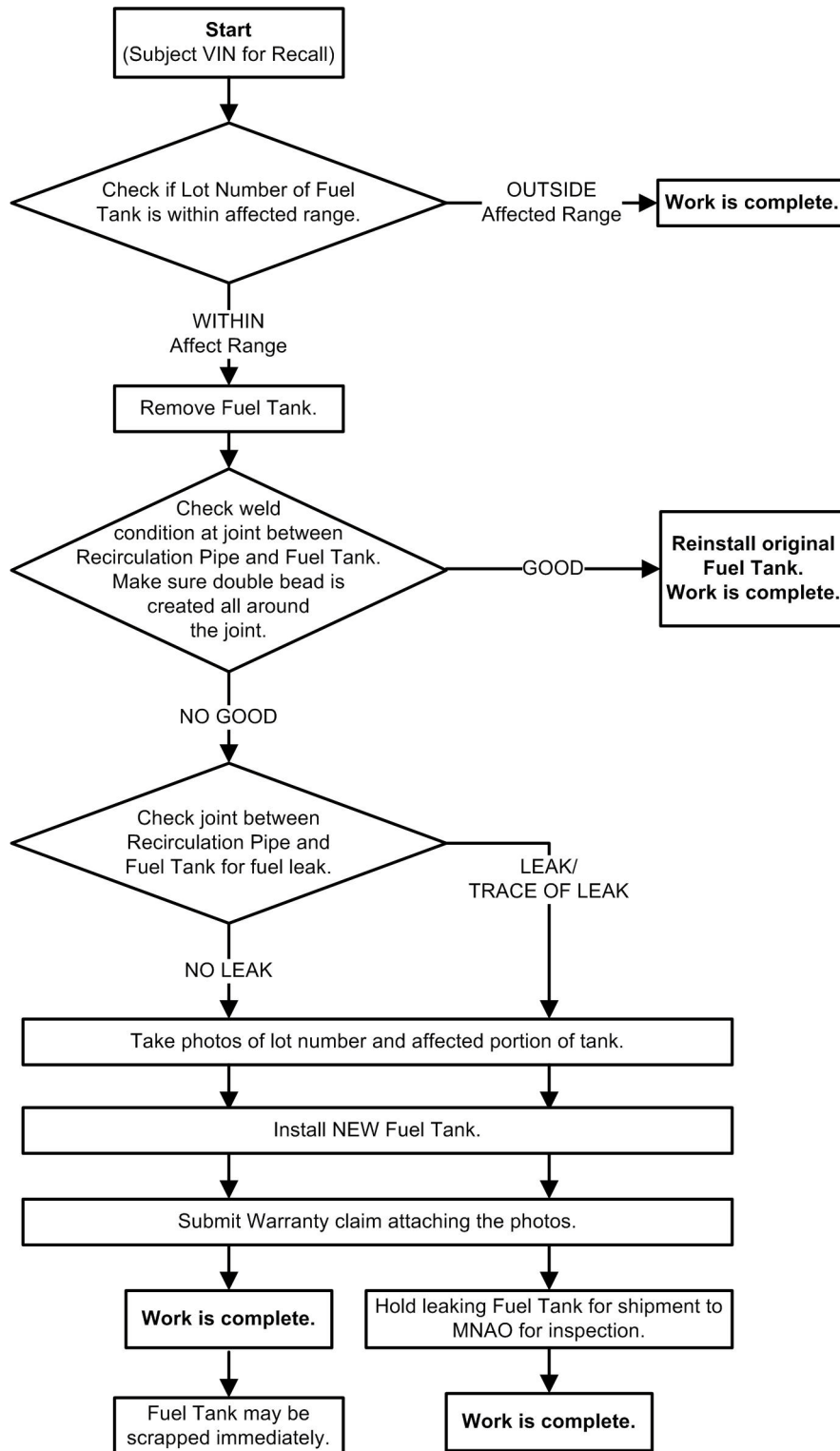

C. INSPECTION AND REPAIR PROCEDURE

1. Lift the vehicle up.
2. Read the lot number on the label on the fuel tank.

NOTE:

- If the lot number cannot be read on the label, wash it off.
- If the lot number still cannot be read after washing it off, go to step 4.



3. Use the Lot Number Calculation Tool to determine if the fuel tank requires further inspection.
 - If the lot number is within the affected range, go to next step.
 - If the lot number is outside the affected range, work is complete.
4. Remove the fuel tank according to the instructions on MS3 (FUEL TANK REMOVAL/INSTALLATION).
5. Visually check the welding condition all around the joint portion between the recirculation pipe and the fuel tank. Make sure a double bead is created all around the joint.

NOTE:

- If the joint portion is not clearly visible, wash it off.
- If it is difficult to check the welding condition after washing it off, go to next step and install a NEW fuel tank.

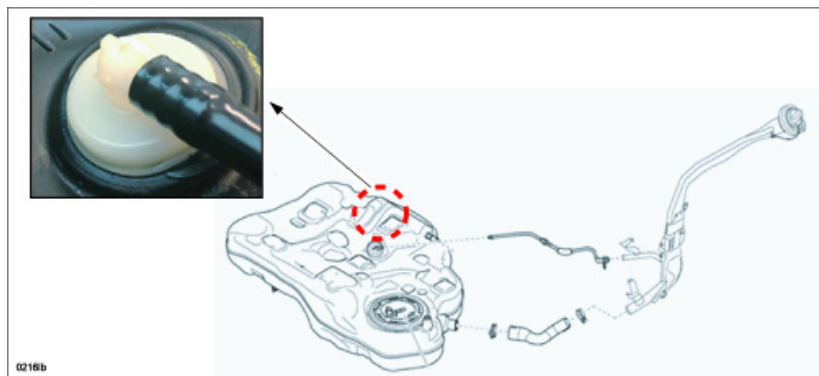

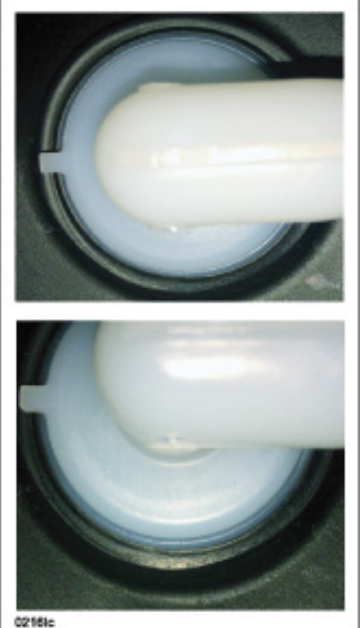
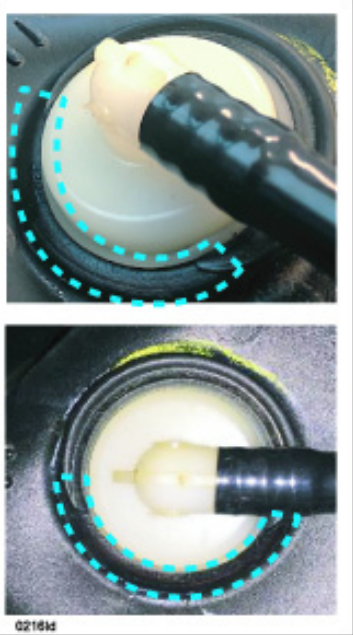
GOOD	NO GOOD
	
Double bead (*) is created all around.	Double bead (*) is NOT created all around.

* Double Bead: If the heated recirculation pipe is press fit (welded) to the heated fuel tank correctly, the double bead is created.

Samples of double-welds that do not need to be replaced.



- If the welding condition is “GOOD”, install the removed fuel tank. Work is complete.
 - If the welding condition is “NO GOOD”, go to next step.
6. Visually check all around the joint portion between the recirculation pipe and the fuel tank for fuel leak.
- NOTE:** If a leak/trace of a leak has been found on the fuel tank, contact PTL@mazdausa.com with photos, dealer code, RO, VIN, and dealership address. A prepaid shipping label will be provided to send the fuel tank to MNAO. MNAO does not expect any fuel tanks to exhibit a leak/trace of a leak.

REPAIR PROCEDURE RECALL 0216I

7. Take photos of lot number and affected portion of the fuel tank.
- Take a photo of the entire recirculation pipe with the joint portion for all cases regardless of leak or not.
 - Take a photo from three angles so that the location of the improper welding (without bead) and its extent can be seen.

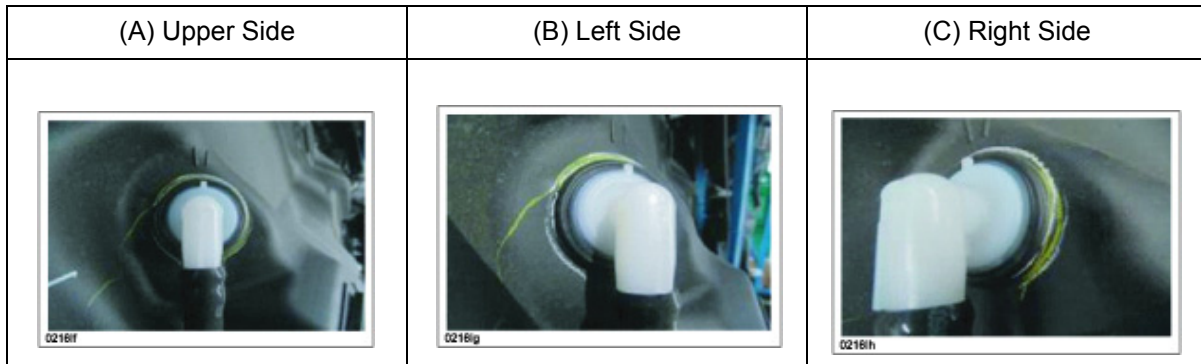
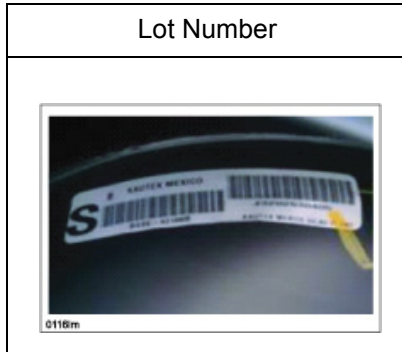

8. Install a NEW fuel tank according to the instructions on MS3 (FUEL TANK REMOVAL/INSTALLATION).
- NOTE:** Visually check that there is no fuel leakage or damage around the reassembled parts (hose, pipe).

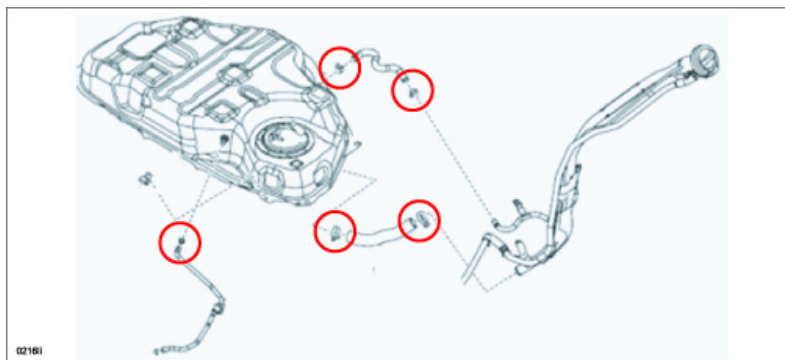

9. Submit a warranty claim attaching the photos taken in step 7.

D. CAMPAIGN LABEL INSTALLATION

1. Fill out a blue "Campaign Label" (9999-95-065A-06) with Campaign No: "0216I", your dealer code, today's date.

CAMPAIGN LABEL	
CAMPAIGN NO:	_____
DEALER CODE:	_____
DATE:	/ /

P/N 9999-95-065A-06

1326b

2. Affix it to the hood or bulkhead as shown:

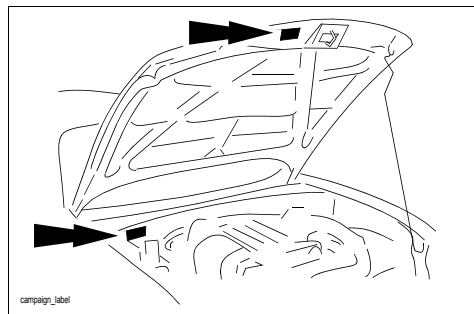

3. Return the vehicle to customer.