

IMPORTANT UPDATE

TECHNICAL INSTRUCTIONS FOR SAFETY RECALL GLK REAR LOWER SUSPENSION ARM No.1 CERTAIN 2010 MODEL YEAR HS250h

Updated 11-9-16

- The TI has been updated to include links to the GLK Technician Checklist

Technician Training Requirements

The training requirements that were in effect at the initial launch of GLK in August, 2016 will remain applicable until December 18, 2016. In November 2016 a new eLearning Module LSCGLK will be available, an announcement will be sent informing technicians when this course is available. Starting on December 19, 2016 the training requirements will be updated and all technicians performing GLK **MUST** meet the updated training requirements.

Initial Training Requirements

All dealership technicians performing this recall are required to successfully complete the most current version of the E-Learning course "Safety Recall and Service Campaign Essentials" To ensure that all vehicles have the repair performed correctly; only Lexus technicians with successful completion of L453, LSC13C and hold at least one of the following certification level are approved to conduct this repair:

- Senior
- Master
- Diagnostic Specialist

Updated Training Requirements – In effect starting 12/19/2016

All dealership technicians performing this repair are required to successfully complete the most current version of the E-Learning course "Safety Recall and Service Campaign Essentials". To ensure that all vehicles have the repair performed correctly; Lexus technicians performing this repair **must successfully complete elearning LSCGLK**, received the hands on training LSCGLKH, completed L453 and hold at least one of the following certification levels:

- Senior
- Master
- Diagnostic Specialist

It is the dealership's responsibility to select technicians with the above certification level or greater to perform this repair. Carefully review your resources, the technician skill level, and ability before assigning technicians to this repair. It is important to consider technician days off and vacation schedules to ensure there are properly trained technicians available to perform this repair at all times.

If you have questions regarding training, contact your regional representative.

I. OPERATION FLOW CHART

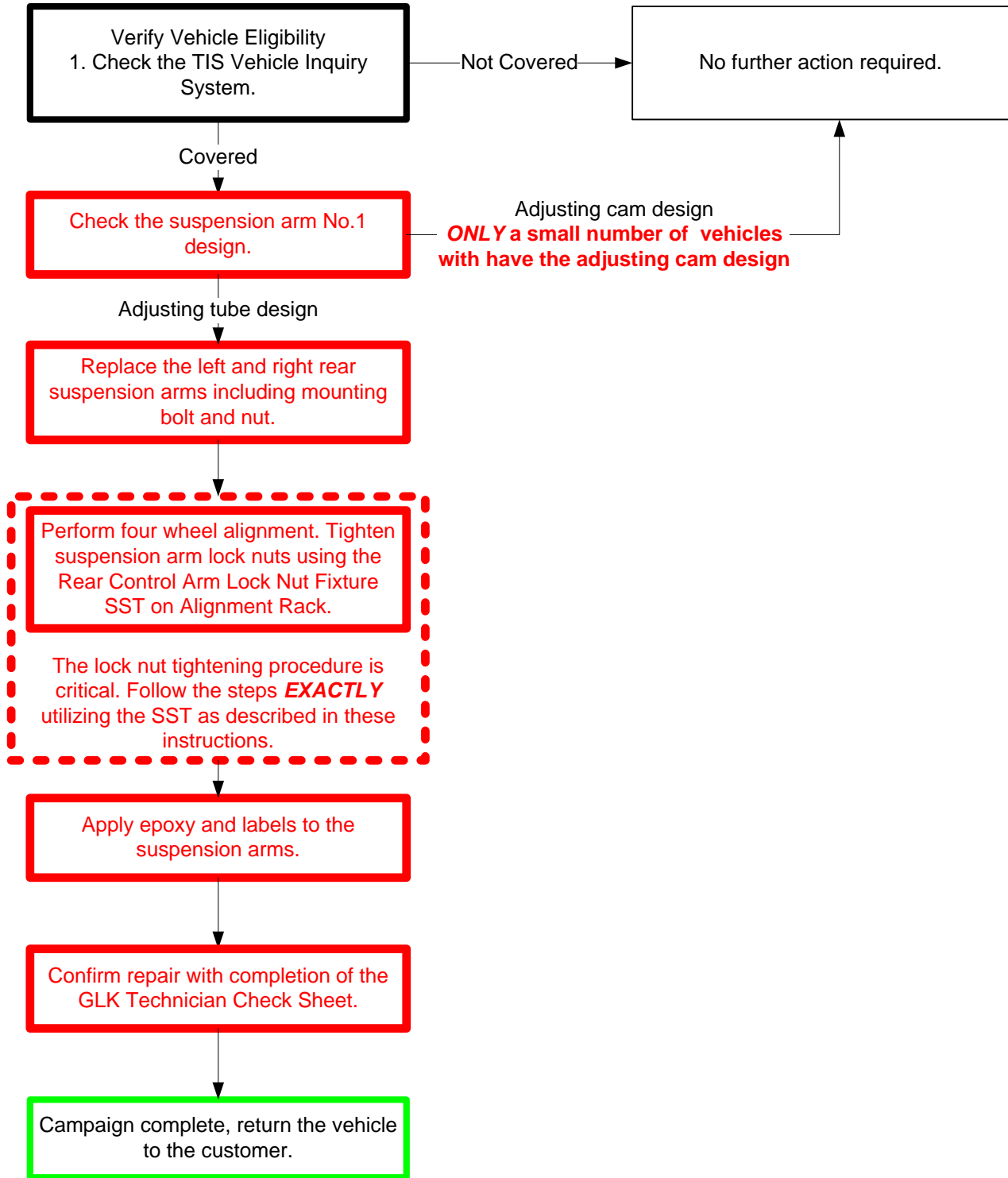

I. BACKGROUND

In the earlier action, if the nuts for adjusting rear wheel alignment were improperly tightened when an alignment was performed, rust could form on suspension arm threads. If this occurs, and if the condition is not identified and remedied during servicing or repair under the existing remedy procedure, the threads can wear over time, causing the arm to separate, which could result in a loss of vehicle control.

II. PREPARATION

A. PARTS

The epoxy kit required for each vehicle can be ordered through the Lexus Complete Maintenance Care Program (LCMC) and will be drop shipped from AMREP.

Part Number	Part Description	Quantity
00289-SW1LX-DS	Epoxy Kit	1
*The kit above includes the following parts.		
-	50ml Epoxy Cartridge	1
-	Mixing Nozzle	1
-	Caution Labels	2

All vehicles will require this epoxy kit.

Part Number	Part Description	Quantity
91672-L1270	Bolt (Suspension arm to rear sub-frame)	2
90080-17221	Nut	2
04002-36112	Rear Suspension Arm No.1 Kit*	2
*The kit above includes the following parts.		
48710-12270	Rear Lower Suspension Arm No.1	1
90179-12027	Nut	1

***Two kits are required per vehicle.**

B. TOOLS & EQUIPMENT

- Standard hand tools
- Torque wrench
- 22mm crowfoot
- 4 Wheel alignment machine



C. MATERIALS

- FIGP 00295-00103 – Needed if voids are found in the epoxy, follow these instructions for details
- Frekote Liff Mold Release 00289-HKLMR-DS – Quantity: 1 can, one can will cover approximately 75 vehicles (Order through the Lexus Complete Maintenance Care Program)
- [GLK Technician Checklist](#)

SST – This is an essential special service tool that the dealership should have.

Part Number	Part Name	Quantity
09960-20010	Ball Joint Puller Set	1

CAMPAIGN TOOLS – These tools were provided to the dealership at the launch of CSE. These tools are necessary when performing this repair.

Image	Name	Quantity
	Epoxy Mold Set	4 halves / 2 complete molds
	Epoxy Applicator*	1
	22mm Crowfoot	1

***NOTE: These tools CANNOT be ordered through the parts or tools system. There is a very limited supply of tools, but if additional tools are needed, contact your area representative.**

This tool was provided to the dealership for use while performing GLK. This tool is **REQUIRED** when performing this repair.

Image	Name	Quantity
 A black, L-shaped metal torque fixture with a central threaded rod and a handle.	Rear Control Arm Torque Fixture	1

III. IDENTIFICATION OF AFFECTED VEHICLES

NOTE:

- Check the TIS Vehicle Inquiry System to confirm the VIN is involved in this Safety Recall, and that the campaign has not already been completed prior to dealer shipment or by another dealer.
- TMS warranty will not reimburse dealers for repairs conducted on vehicles that are not affected or were completed by another dealer.

IV. COMPONENTS

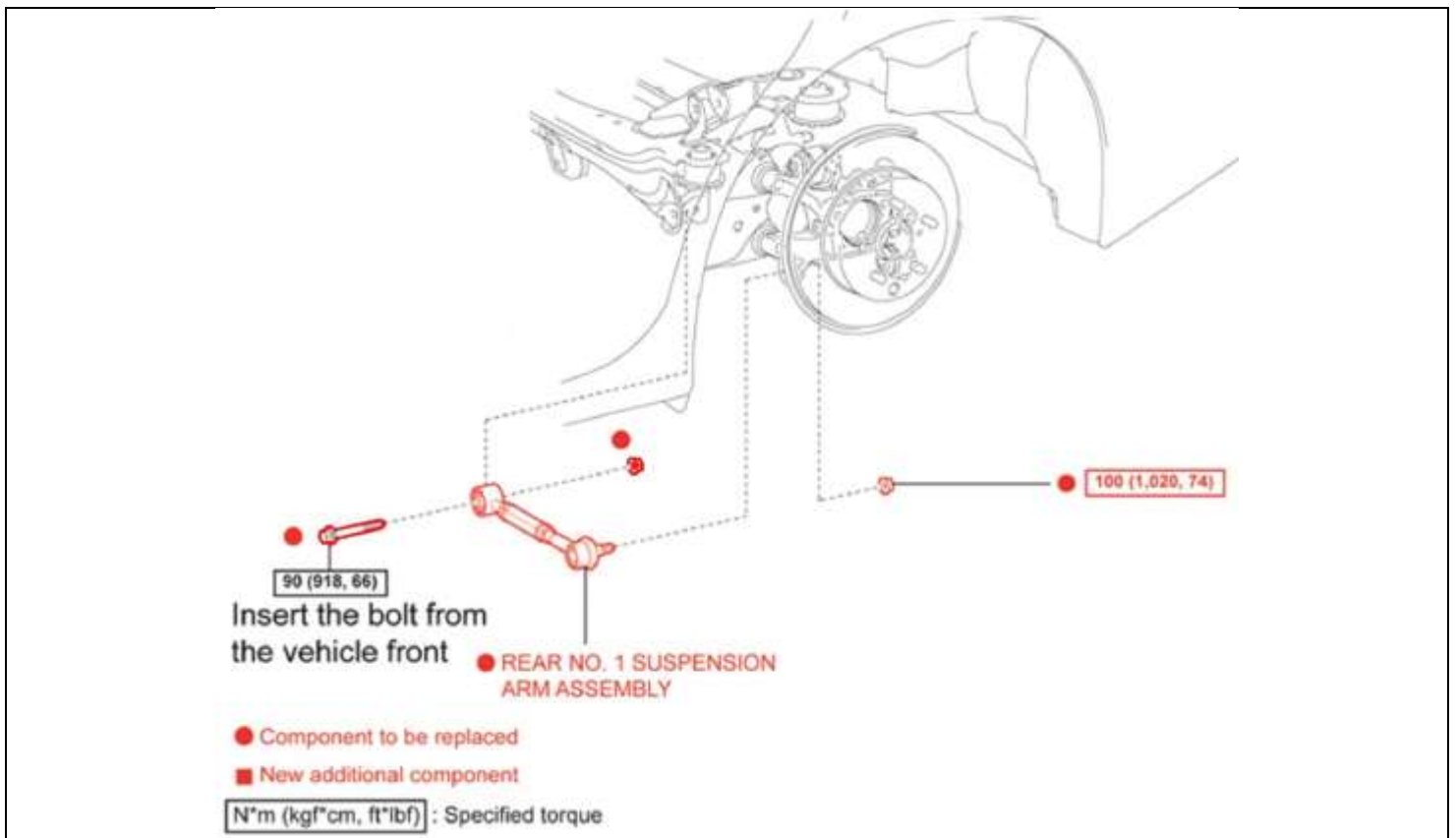

V. REAR LOWER SUSPENSION ARM No.1 INSPECTION

1. CHECK THE SUSPENSION ARM DESIGN

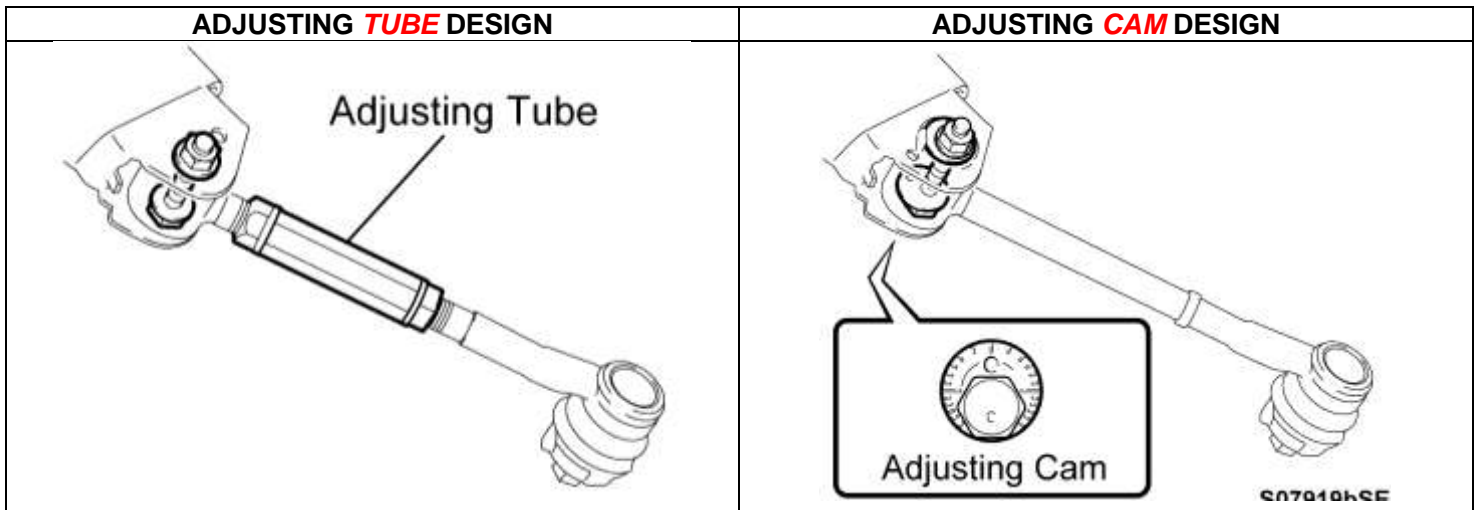

ARM DESIGN	ACTION REQUIRED
Adjusting Tube	Proceed to Section VI Replace Both Rear No. 1 Suspension Arms
Adjusting Cam	No further action required. Campaign complete.

VI. REPLACE BOTH REAR NO.1 SUSPENSION ARMS

[Video supplement: Rear Control ARM Replacement](#)



Note: The remedy has been changed. The recall now requires that the left and right Rear No. 1 Suspension Arms be replaced on all vehicles.

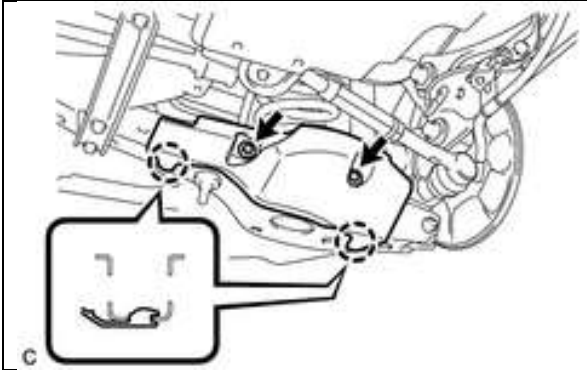

- 1. REMOVE REAR SUSPENSION ARM COVER**
 - a) Remove the two bolts and disengage the 2 claws.
 - b) Remove rear suspension arm cover.
 - c) Repeat on other side.

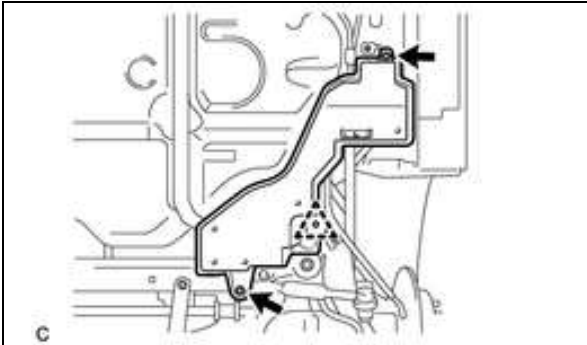

- 2. REMOVE REAR FLOOR SIDE MEMBER COVER LH SIDE**
 - a) Remove the nut and bolt.
 - b) Disengage the clip and remove the cover.

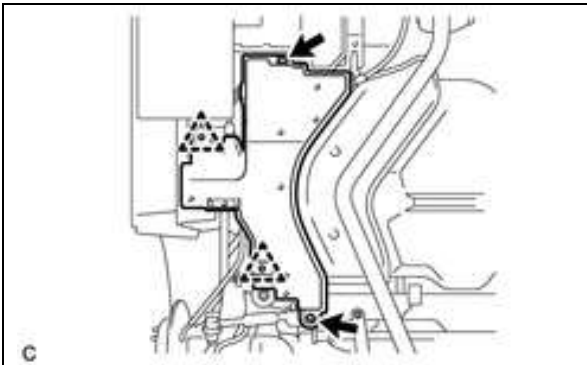

- 3. REMOVE REAR FLOOR SIDE MEMBER COVER RH SIDE**
 - a) Remove the 2 bolts.
 - b) Disengage the 2 clips and remove the cover.

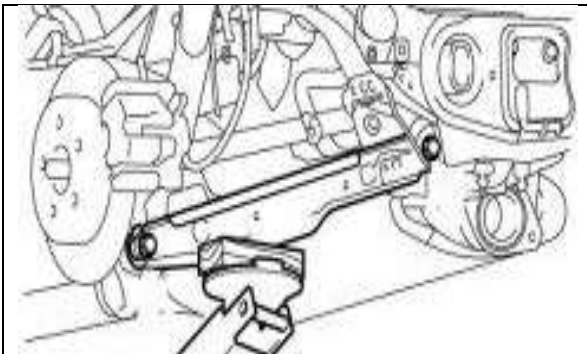

- 4. REAR NO.1 SUSPENSION ARM ASSEMBLY REMOVAL**
 - a) Support the No.2 suspension arm.

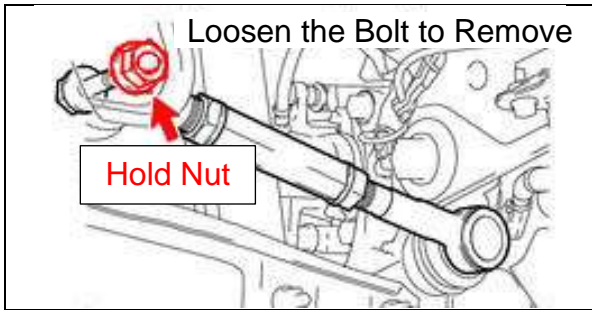

- b) Remove the bolt and nut, by holding the nut and loosening the bolt.

NOTE: The nut securing the bolt to the suspension member is serrated.

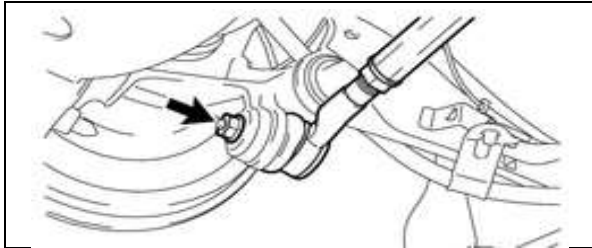

- c) Remove the nut securing the No.1 rear suspension arm ball joint to the axle carrier.

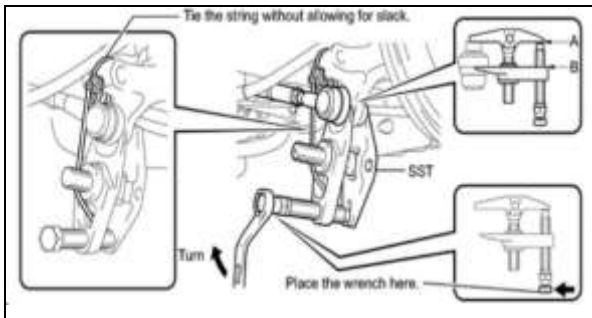

- d) Using the SST, disconnect the suspension arm from the axle carrier.

SST: 09960-20010

- e) Repeat on the opposed side.

5. REAR NO.1 SUSPENSION ARM ASSEMBLY INSTALLATION (both right and left arms)

- a) Temporarily install the suspension arm by installing the **NEW** bolt from the front of the vehicle into the suspension member and rear No.1 suspension arm assembly.
 f) Insert the ball joint stud into the axle carrier and hand tighten the nut onto the stud.

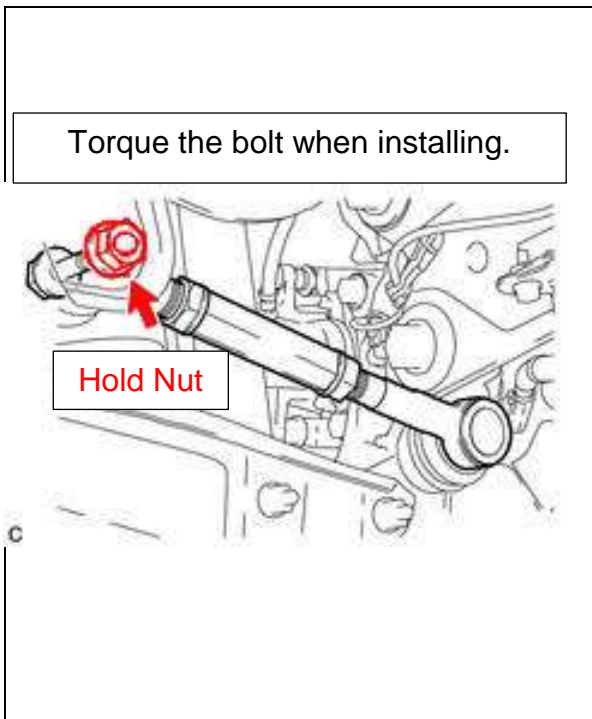

- b) Lower the vehicle and place the weight of the vehicle onto the suspension.

NOTE: To prevent stress on the new suspension arm bushing, apply a load to the suspension to align the arm correctly when tightening. The suspension arm should be parallel with the ground.

- c) Install the **NEW** nut by hand onto the bolt securing the arm to the suspension member.

- d) Torque the bolt to spec while holding the nut.
Torque: Bolt: 90 N-m (918 kgf-cm, 66 lbf)



- e) Torque the ball joint nut to spec.

Torque: Nut: 100 N-m (1020 kgf-cm, 74 lbf)

- f) **Check the boxes on the [GLK Technician Checklist](#) indicating you replaced both rear suspension arms as instructed by the technical instructions.**

VII. SUSPENSION ARM ADJUSTMENT AND WHEEL ALIGNMENT

[Video Supplement: Alignment Procedure](#)



1. **INSPECT ALIGNMENT RACK FOR PROPER OPERATION**
 - a) Pull the pins on both the front turn plates and rear slide plates of the alignment rack and confirm the slide plates move freely with no binding.
 - b) Ensure that the alignment rack is properly calibrated based on the manufacturers requirements.



2. **DRIVE VEHICLE ONTO ALIGNMENT RACK**
 - a) Drive the vehicle straight onto the alignment rack.

Note: If your shop requires a sharp turn to get the vehicle on the alignment rack, always back the vehicle up prior to driving up on the lift. This will reduce the stress placed on the rear suspension during the turn and will help the suspension settle.



3. **JOUNCE THE VEHICLE TO SETTLE SUSPENSION**
 - a) Ensure the tires are on the turn and slide plates.
 - b) Pull the pins on the turn and slide plates to allow the suspension to settle.
 - c) Jounce the front and rear of the vehicle to reset the suspension prior to vehicle alignment.

Ensure pins are pulled prior to jouncing suspension.



4. **PERFORM 4 WHEEL ALIGNMENT**
 - a) **Record the before and after alignment measurements of the vehicle onto the R.O. and check the box on the [GLK Technician Checklist](#) confirming you have properly aligned the vehicle.**



Make sure to set the alignment of the vehicle as close to the middle of the spec as possible.

VIII. REAR CONTROL ARM TORQUE SEQUENCE



THE CONTROL ARM TORQUE SEQUENCE IS REQUIRED TO BE PERFORMED ON THE ALIGNMENT RACK AND WITH THE REAR CONTROL ARM TORQUE FIXTURE SST. ENSURE TO FOLLOW INSTRUCTIONS EXACTLY AS DESCRIBED.



Video Supplement: Rear Control ARM Lock Nut Torque Procedure



1. INSTALL THE REAR CONTROL ARM TORQUE FIXTURE

- Confirm that the clamp section is open and the crowfoot attachment of the SST is loose so it can swing and slide freely.
- Engage the crowfoot of the SST onto the adjusting tube.



Ensure the adjusting tube does not move when installing the SST, otherwise the alignment will be affected.



- Slide the crowfoot attachment with in the groove of the SST body and install the C-clamp onto the suspension member.
- Hand tighten the C-clamp until it secure against the suspension member.



- Tighten the crowfoot attachment to the body of the SST.
- Tighten the C-clamp until it is secure.
- Secure the Rear Control Arm Torque Fixture to the vehicle with the tether.

Note: The SST only needs to be snug, do not over torque the tool to the suspension member.

2. TORQUE THE REAR CONTROL ARM LOCK NUTS

- Torque rear control arm lock nuts in the following sequence:
 - Torque Inboard Lock Nut to 41 ft. lbs
 - Torque Outboard Lock Nut to 41 ft. lbs
 - Retorque Inboard Lock Nut to 41 ft. lbs
- Confirm the alignment did not change during the torquing sequence and that it is still as close to the middle of the alignment spec as possible.
- Record verified torque onto the technician check sheet.
- Repeat procedure for other rear control arm.
- Record the final torque values achieved at each rear control arm lock nut onto the [GLK Technician Checklist](#) and confirm that the SST was used during the torquing sequence.**

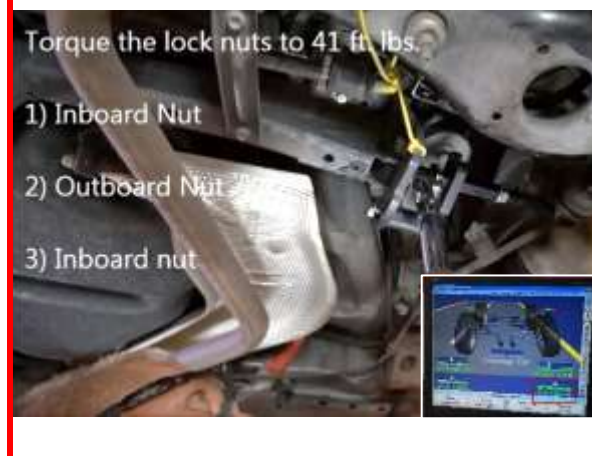

3. PERFORM TEST DRIVE TO CONFIRM VEHICLE DRIVE ABILITY



THE CONTROL ARM TORQUE SEQUENCE IS REQUIRED TO BE PERFORMED ON THE ALIGNMENT RACK AND WITH THE REAR CONTROL ARM TORQUE FIXTURE SST. ENSURE TO FOLLOW INSTRUCTIONS EXACTLY AS DESCRIBED.



IX. SUSPENSION ARM EPOXY APPLICATION

Video Supplement: Epoxy Application Steps



Confirm that vehicle alignment, and lock nut tightening have all been performed correctly before proceeding.

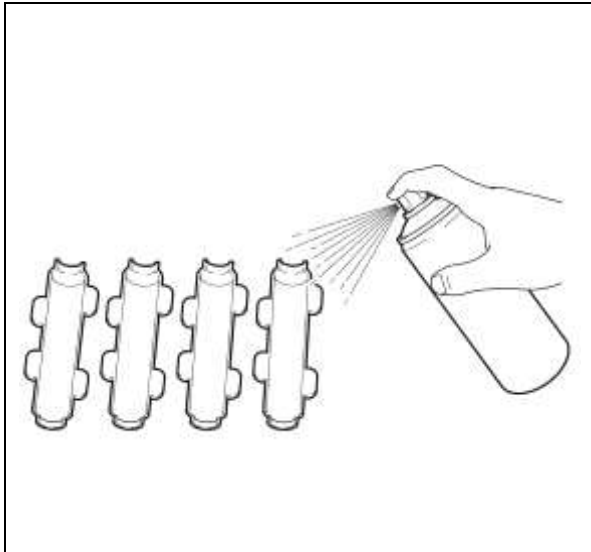

1. PREPARE THE EPOXY MOLDS

- Confirm there is no dried epoxy or debris in the molds.
- If there is dried epoxy in the molds, use brake clean and a rag or soft bristled brush to clean the epoxy. **DO NOT use a metal brush or anything that may damage the mold.**
- Hold the can about 8 inches from the molds, and apply two light coats of the mold release to the molds.
- Once the mold release has dried, there should be no wet pools in the molds.



- DO NOT** spray the mold release near any vehicle electrical components or they may be damaged, refer to [L-SB-0066-11](#) for more details.
- The mold release typically takes approximately 60 seconds to set, but may take longer depending on temperature.

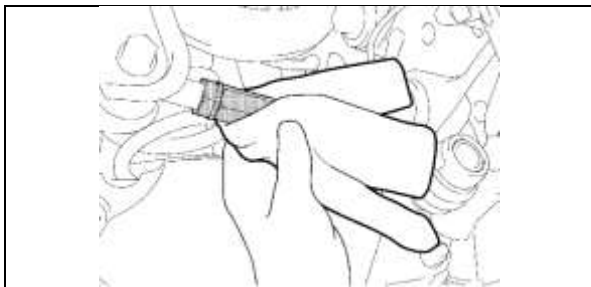

- Use a rag and brake clean to finish cleaning the arm.



Cleaning the exterior surface of any dirt and oil, (including a new arm) is **CRITICAL** to ensure that the epoxy adheres properly.

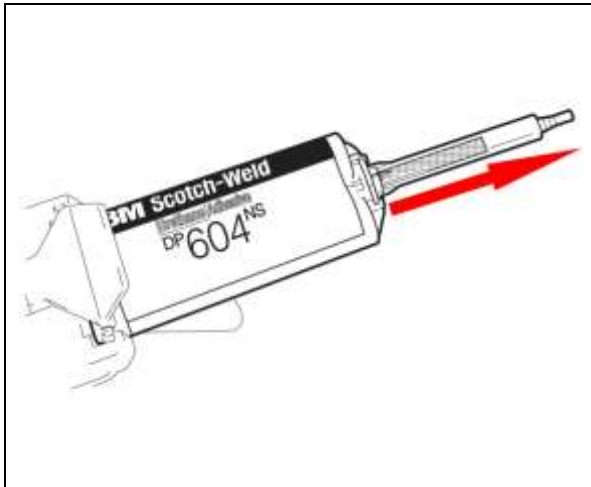

2. FILL THE MOLDS WITH EPOXY

- Assemble the applicator by following the instructions included in the applicator box.
- Install the epoxy cartridge into the applicator.
- Install the mixing nozzle onto the cartridge.
- Start by squeezing the handle to pre-fill the mixing tube until the epoxy reaches the end of the nozzle, then stop squeezing.



Pre-filling the mixing nozzle is critical to ensure the molds are each filled with even amounts of epoxy in the following steps.

NOTE: Confirm the one-to-one ratio plunger is installed in the applicator.

3. FILL THE MOLDS WITH EPOXY



- One complete epoxy cartridge should be used for every 2 suspension arms.
- There are approximately 12 full squeezes of epoxy in each cartridge.
- Follow these steps exactly as described so there are no voids in the epoxy when installed on the suspension arm.

a) Apply two full squeezes of the epoxy along the length of each mold. (eight total squeezes)

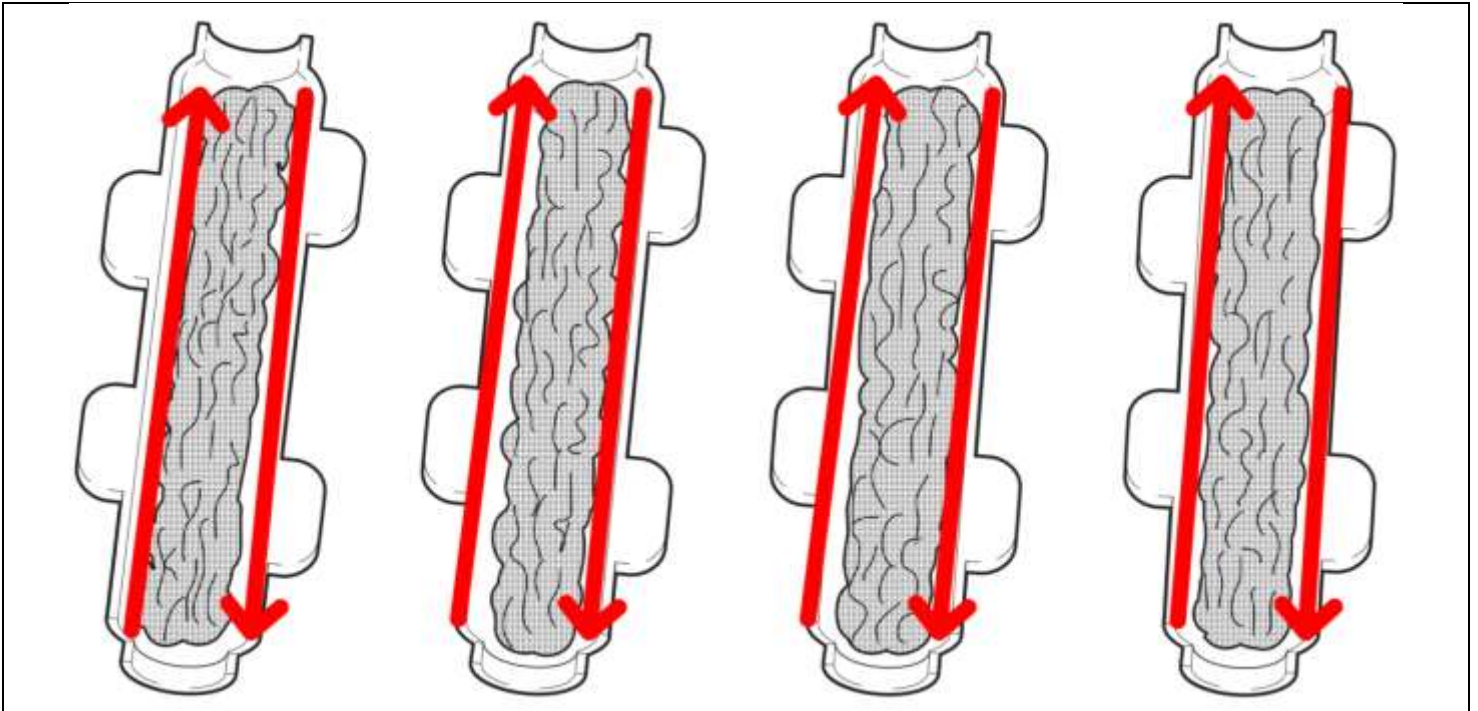

b) Apply the remaining 3-4 squeezes evenly in the upper and lower thirds of the molds.

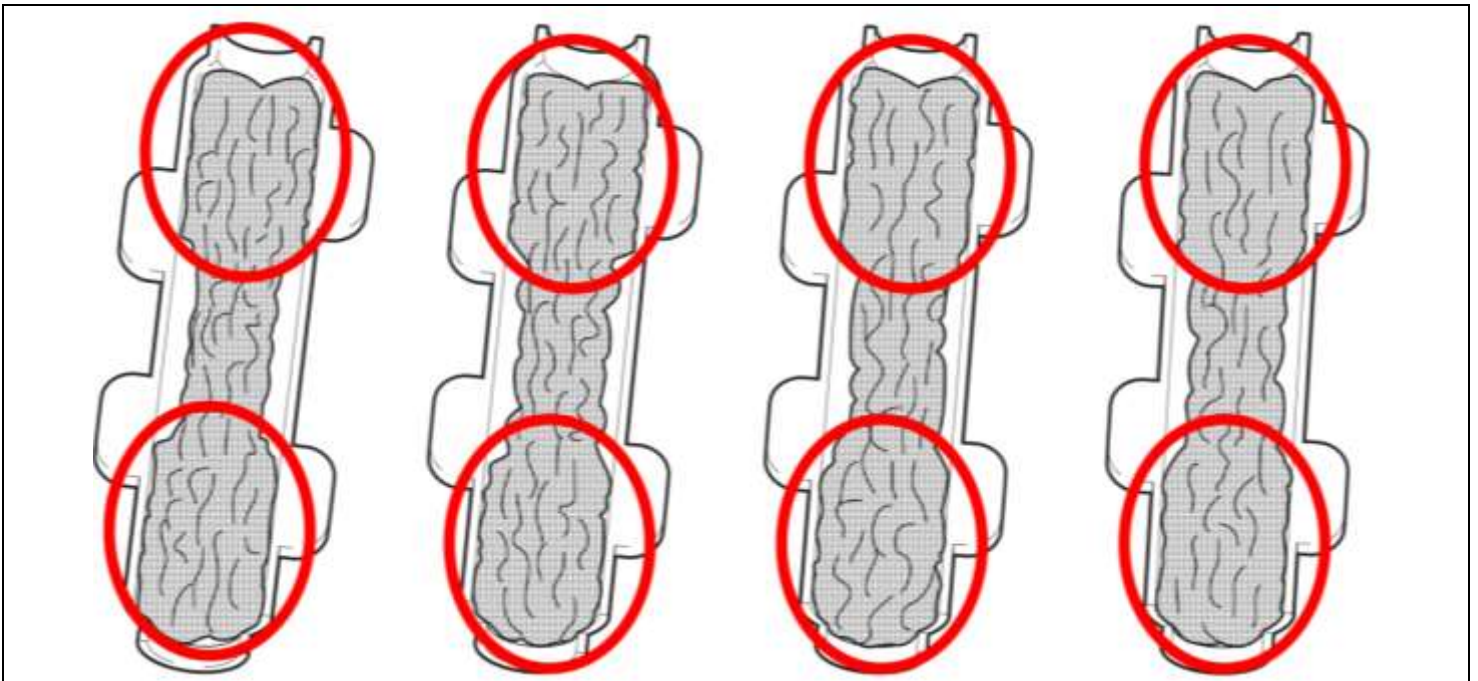

- It is important that the epoxy is filled evenly between the four mold halves.
- If the molds have an uneven amount of epoxy, pair the mold with the least amount of epoxy and the one with the most epoxy together to avoid creating voids in the epoxy.

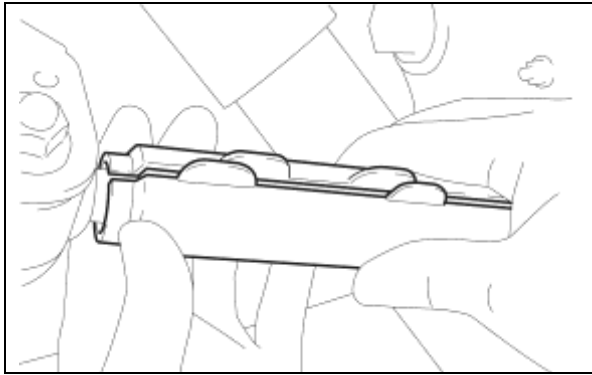

4. INSTALL THE MOLDS ON THE SUSPENSION ARMS

- a) Confirm the molds are centered over the adjusting tube and lock nuts, then place them on the arm.
- b) Press the mold halves together and confirm the edges of the mold halves are aligned with each other.

 **The mold should be installed within 5 minutes of dispensing the epoxy to ensure the epoxy adheres properly.**

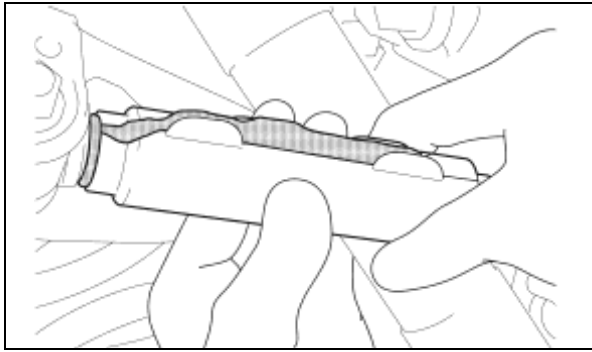

- c) The epoxy should be forced out evenly along the parting lines to indicate a good fill.
- d) There is **NO NEED** to wipe the epoxy along the parting lines, it can be trimmed easily once it has set.

NOTE: There is no need to clamp the molds, the epoxy will hold the molds in place.

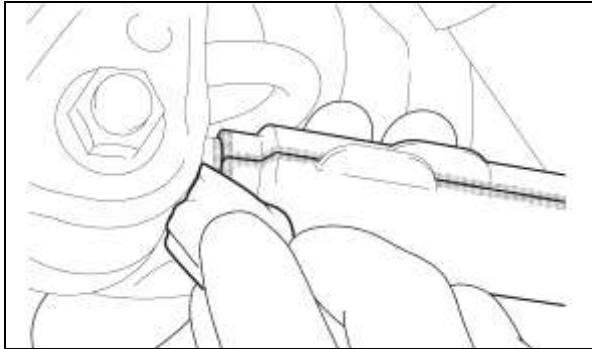

- e) Confirm the epoxy at the ends of the mold is clean and smooth.

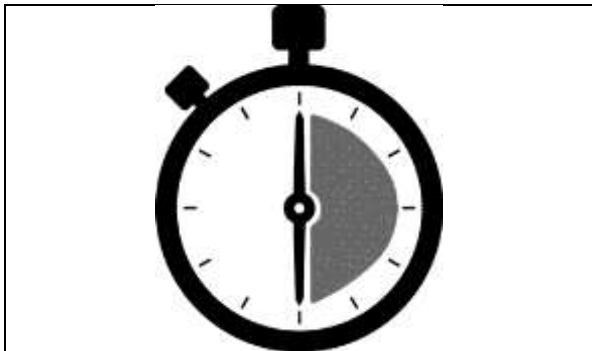

5. ALLOW THE EPOXY TO SET

- a) Allow the epoxy to set for at least 30 minutes.

 **The set time is temperature dependent, it will take longer in cold temperatures.**

- **In temperatures below 50°F it may take 60 minutes or longer and in temperatures below 0°F it may take 90 minutes or longer.**
- **DO NOT** apply heat to speed the set time.

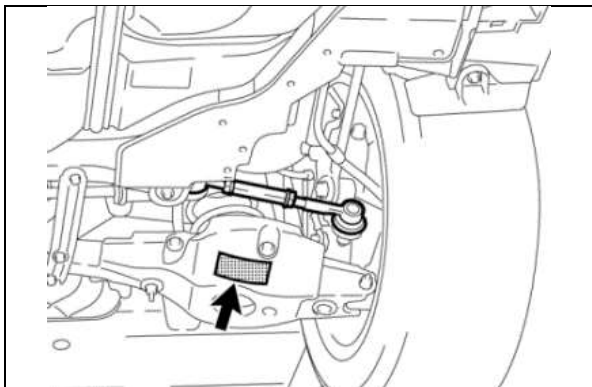

6. REMOVE THE CAUTION LABELS FROM SUSPENSION ARM No.2

- a) Remove the labels from the front and back sides of suspension arm No.2.

NOTE:

- **This step only needs to be performed if recall CLE was previously performed and caution labels are still present.**
- **It may be necessary to heat the labels with a heat gun to ease removal.**

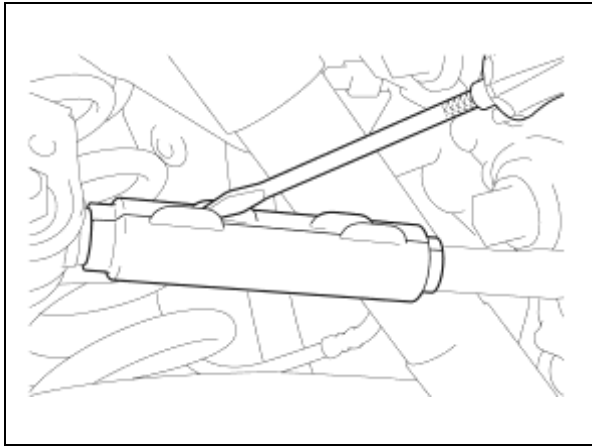

7. REMOVE THE MOLDS

- a) In cold temperatures, confirm the epoxy has set by touching it prior to removing the molds.
- b) After the epoxy has set for a minimum of 30 minutes, the molds can be removed.
- c) Use a screwdriver on the mold tabs to remove the molds.



- **DO NOT** remove the molds early or the epoxy may be damaged.
- **DO NOT** twist the molds during removal, this may deform the epoxy.
- It is normal for the epoxy to still be flexible, the epoxy will cure over the next 6-8 hours.

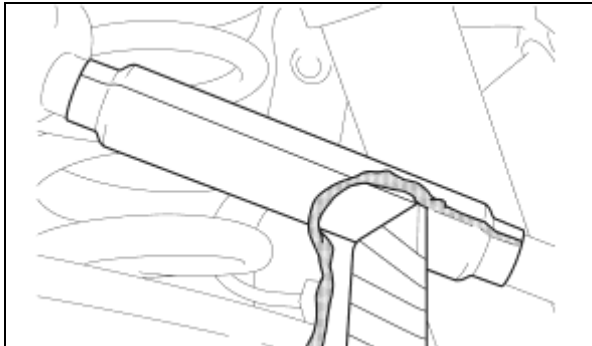

8. TRIM AND CLEAN THE EPOXY

- a) Trim the excess epoxy from the parting lines using a razor.

NOTE: The excess epoxy *MUST* be trimmed for the caution label adhere properly.



- b) Wipe the epoxy clean using a shop cloth to remove any remaining mold release.



DO NOT use brake clean on the epoxy.

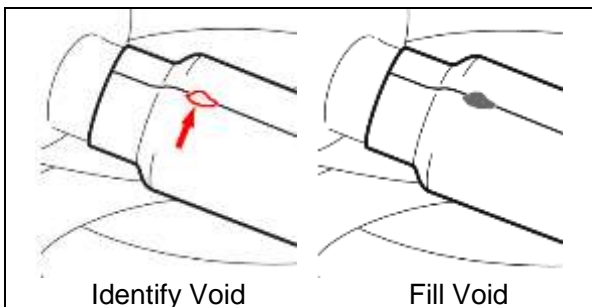

Identify Void

Fill Void

9. INSPECT FOR VOIDS

- a) Inspect the epoxy for any voids that expose the arm.
- b) If any voids are identified, fill with FIGP.



There should be no voids that expose the arm if the molds were filled correctly with epoxy.



10. APPLY CAUTION LABEL

- a) Wrap the caution label around the epoxy.

NOTE: The label is designed to overlap over itself by approximately 3/8”.

- b) **Check the box on the [GLK Technician Checklist](#) confirming the epoxy has been properly applied to the arms and that the caution label has been installed.**

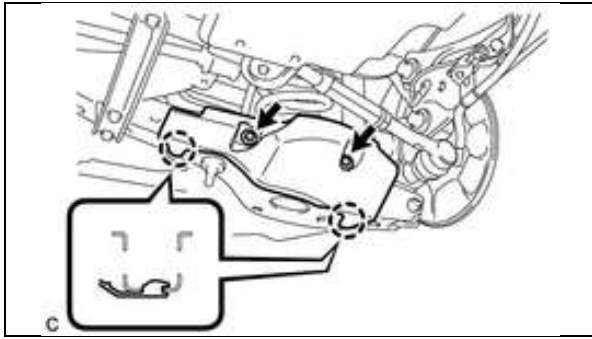

11. REINSTALL REAR SUSPENSION ARM COVER

- a) Reinstall the cover by engaging the two claws.
- b) Install two bolts.

Torque: 12 Nm (122 kgfcm, 9ft-lbf)

- c) Repeat on other side.

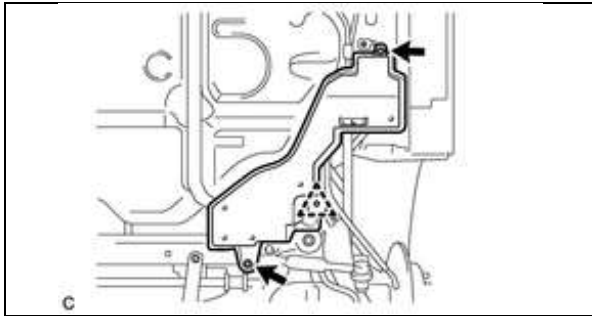

12. REINSTALL REAR FLOOR SIDE MEMBER COVER LH SIDE

- a) Reinstall the cover by engaging the clip.
- b) Reinstall the nut and bolt.
- c) Disengage the clip and remove the cover.

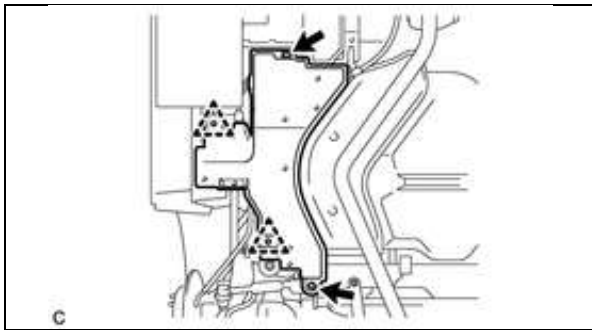

13. REINSTALL REAR FLOOR SIDE MEMBER COVER RH SIDE

- a) Reinstall the cover by engaging the 2 clips.
- b) Reinstall the 2 bolts.

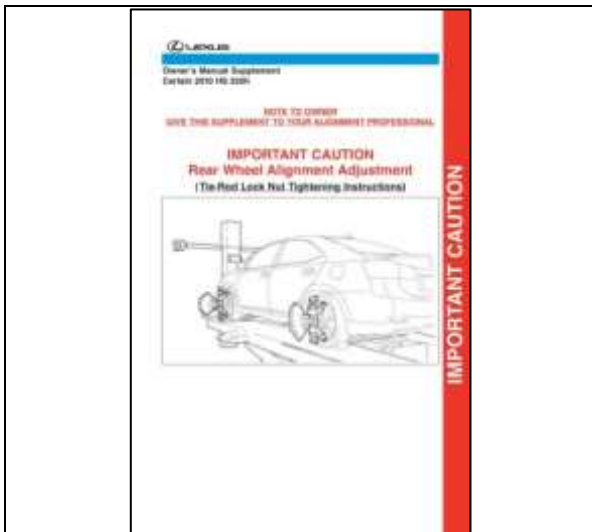

14. REMOVE THE OWNER'S MANUAL SUPPLEMENT

- a) Remove and discard the owner's manual supplement located in the glove box.

NOTE: This step only needs to be performed if recall CLE was previously performed. The owner's manual supplement can be found in the glove box.

◀ VERIFY REPAIR QUALITY ▶

- Confirm **ALL** inspection steps are followed **EXACTLY** as described in these instructions
- Confirm the lock nut tightening procedure is followed **EXACTLY** as described in these instructions
- Confirm vehicle alignment is correct prior to applying epoxy to the arm
- Confirm the epoxy is applied correctly and that the caution label is installed
- Confirm the [GLK Technician Checklist](#) has been completed and a copy has been retained with the R.O.
-

If you have any questions regarding this update, please contact your area representative.

X. APPENDIX

A. CAMPAIGN DESIGNATION DECODER

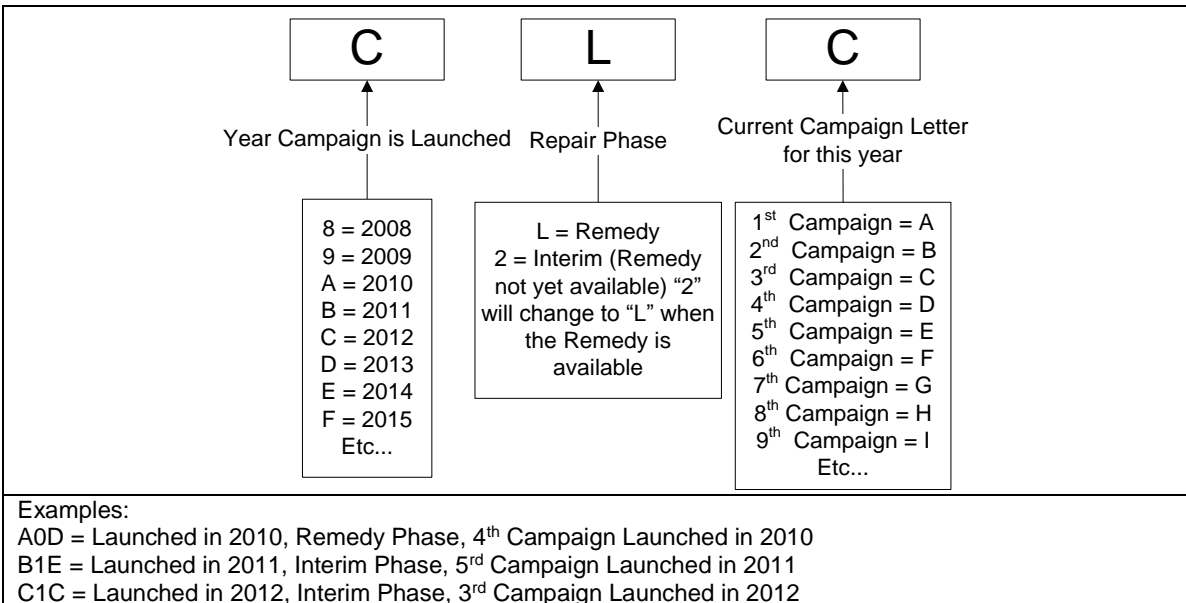

B. CAMPAIGN PARTS DISPOSAL

Make sure all campaign parts (original parts) removed from the vehicle are disposed of in a manner in which they will not be reused, ***unless requested for parts recovery return.***

GLK Molds Available for Purchase

Part # 569949-REG

(Enough for one side)



(2 Halves)

Call 800-933-8335

Molds sets to perform Safety Recall GLK are now available for purchase from Lexus' SST supplier Bosch Automotive Service Solutions. Mold sets will be sold with 2 mold halves (as shown in picture). In order to apply the epoxy simultaneously to both the left and right arms of the vehicle you must order two sets.