

December 7, 2018

Version 10

## Safety Recall: Front Passenger's Airbag Inflator Can Be Over-Pressurized (Phase 1)

Supersedes 16-047, dated February 1, 2017 to revise the information highlighted in **yellow**.

Replaces 14-046, Recall: Front Passenger's Airbag Inflator May Produce Excessive Pressure After Long-Term Exposure To High Absolute Humidity

Replaces 14-070, Safety Recall: Front Passenger's Airbag Inflator May Produce Excessive Pressure After Long-Term Exposure To High Absolute Humidity

*Following NHTSA direction, there are five phases based on three different zones.*

*If the iN VIN status inquiry directs you to do this campaign, follow the applicable procedure regardless of where the vehicle is currently located because it may have moved between different states. Make sure you file a claim using the correct warranty claim information to avoid your claim being rejected.*

### AFFECTED VEHICLES

#### Zone A

Year	Model	Trim	VIN Range
2005-06	CR-V	ALL	Check the iN VIN status for eligibility
2003-06	Element	ALL	Check the iN VIN status for eligibility
2007-11	Element	ALL	Check the iN VIN status for eligibility
2007-08	Fit	ALL	Check the iN VIN status for eligibility
2002-04	Odyssey	ALL	Check the iN VIN status for eligibility
2003-08	Pilot	ALL	Check the iN VIN status for eligibility
2006	Ridgeline	ALL	Check the iN VIN status for eligibility
2007-08	Ridgeline	ALL	Check the iN VIN status for eligibility
2009-11	Ridgeline	ALL	Check the iN VIN status for eligibility

Zone A applies to model year 2011 and older vehicles that are located or ever registered in: Alabama, California, Florida, Georgia, Hawaii, Louisiana, Mississippi, South Carolina, Texas, Puerto Rico, American Samoa, Guam, the Northern Mariana Islands (Saipan), and the U.S. Virgin Islands.

#### Zone B

Year	Model	Trim	VIN Range
2005-06	CR-V	ALL	Check the iN VIN status for eligibility

**CUSTOMER INFORMATION:** The information in this bulletin is intended for use only by skilled technicians who have the proper tools, equipment, and training to correctly and safely maintain your vehicle. These procedures should not be attempted by "do-it-yourselfers," and you should not assume this bulletin applies to your vehicle, or that your vehicle has the condition described. To determine whether this information applies, contact an authorized Honda automobile dealer.

Year	Model	Trim	VIN Range
2003-06	Element	ALL	Check the iN VIN status for eligibility
2007-08	Element	ALL	Check the iN VIN status for eligibility
2007-08	Fit	ALL	Check the iN VIN status for eligibility
2002-04	Odyssey	ALL	Check the iN VIN status for eligibility
2003-08	Pilot	ALL	Check the iN VIN status for eligibility
2006	Ridgeline	ALL	Check the iN VIN status for eligibility
2007-08	Ridgeline	ALL	Check the iN VIN status for eligibility

Zone B applies to model year 2008 and older vehicles that are located or ever registered in: Arizona, Arkansas, Delaware, District of Columbia, Illinois, Indiana, Kansas, Kentucky, Maryland, Missouri, Nebraska, Nevada, New Jersey, New Mexico, North Carolina, Ohio, Oklahoma, Pennsylvania, Tennessee, Virginia, and West Virginia.

### Zone C

Year	Model	Trim	VIN Range
2003-04	Element	ALL	Check the iN VIN status for eligibility
2002-04	Odyssey	ALL	Check the iN VIN status for eligibility
2003-04	Pilot	ALL	Check the iN VIN status for eligibility

Zone C applies to model year 2004 and older vehicles that are located in: Alaska, Colorado, Connecticut, Idaho, Iowa, Maine, Massachusetts, Michigan, Minnesota, Montana, New Hampshire, New York, North Dakota, Oregon, Rhode Island, South Dakota, Utah, Vermont, Washington, Wisconsin, and Wyoming.

## REVISION SUMMARY

**New part numbers were added that affect PARTS INFORMATION, WARRANTY CLAIM INFORMATION, and REPAIR PROCEDURE.**

## BACKGROUND

NHTSA and its independent expert reviewed the findings of three independent investigations into the Takata air bag inflator ruptures. According to NHTSA, the combination of time, high temperature fluctuations, and humidity contribute to the degradation of the propellant in the inflators. NHTSA has concluded that this degradation can cause the propellant to burn too quickly, creating more pressure than the inflator can withstand, and, in extreme cases, causing the inflator to rupture and send shrapnel through the air bag toward vehicle occupants. NHTSA is prioritizing the recall of air bag inflators based on the risk of injury or death to vehicle occupants.

To comply with NHTSA's direction, American Honda has combined the two the previous campaigns related to airbag inflators that may produce excessive pressure after long-term exposure to high absolute humidity. All the vehicles from S/B 14-046 and 14-070 are included in zone A. Currently there are five planned phases to this campaign. The subsequent phases will launch at a future date per NHTSA direction, but it will be several years before the final phase 5 launches. Additionally, AHM may add new affected models or affected years to each phase. Always do an iN VIN status inquiry to see if a vehicle is affected.

For more information about these inflator recalls, go to [www.safercar.gov](http://www.safercar.gov) and use keyword TAKATA.

### NOTE

**If the VIN status inquiry indicates that the vehicle is subject to any open safety recalls, including the driver's airbag inflator, make sure to also complete those recall repairs before returning the vehicle to the customer. If**

**you are unable to complete any open recall, advise the customer of the recall status and when the recall could be completed.**

### CUSTOMER NOTIFICATION

Owners of affected vehicles will be sent a notification of this campaign.

Do an iN VIN status inquiry to make sure the vehicle is shown as eligible.

Some vehicles affected by this campaign may be in your used vehicle inventory.

Failure to repair a vehicle subject to a recall or campaign may subject your dealership to claims or lawsuits from the customer or anyone else harmed as a result of such failure. To see if a vehicle in inventory is affected by this safety recall, do a VIN status inquiry before selling it.

### CORRECTIVE ACTION

Replace the passenger’s airbag inflator, then return the original, undeployed inflator as directed.

### PARTS INFORMATION

Part Name	Order Part Number	You may receive any of the following	Quantity
2005–06 CR-V Front Passenger’s Airbag Inflator Kit	04790-S9A-315	04790- S9A-A00 04790-S9A-315 04790-S9A-305 (this inflator is no longer produced, but if you have one in stock, it may be installed in a vehicle)	1
2003–06 Element Front Passenger’s Airbag Inflator Kit	04790-SCV-318	04790-SCV-A10 04790-SCV-318 04790-SCV-308 (this inflator is no longer produced, but if you have one in stock, it may be installed in a vehicle)	1
2007–11 Element Front Passenger’s Airbag Inflator Kit (includes one-time use A-pillar clip)	04790-SCV-325	04790-SCV-A00 04790-SCV-325	1
2007–08 Fit Front Passenger’s Airbag Inflator Kit	04790-SLN-315	04790- SLN-A00 04790-SLN-315	1
2002 Odyssey Front Passenger’s Airbag Inflator Kit	04790-S0X-318	04790-S0X-A10 04790-S0X-318 04790-S0X-308 (this inflator is no longer produced, but if you have one in stock, it may be installed in a vehicle)	1

Part Name	Order Part Number	You may receive any of the following	Quantity
2003–04 Odyssey Front Passenger's Airbag Inflator Kit	04790-S0X-315	04790-S0X-A00 04790-S0X-315 04790-S0X-305 (this inflator is no longer produced, but if you have one in stock, it may be installed in a vehicle)	1
2003–04 Pilot Front Passenger's Airbag Inflator Kit	04790-S9V-318	04790-S9V-A10 04790-S9V-318 04790-S9V-308 (this inflator is no longer produced, but if you have one in stock, it may be installed in a vehicle)	1
2005–08 Pilot Front Passenger's Airbag Inflator Kit	04790-S9V-315	04790-S9V-A00 04790-S9V-315 04790-S9V-305 (this inflator is no longer produced, but if you have one in stock, it may be installed in a vehicle)	1
2006 Ridgeline Front Passenger's Airbag Inflator Kit	04790-SJC-318	04790-SJC-A20 04790-SJC-318 04790-SJC-308 (this inflator is no longer produced, but if you have one in stock, it may be installed in a vehicle)	1
2007–08 Ridgeline Front Passenger's Airbag Inflator Kit	04790-SJC-316	04790-SJC-A00 04790-SJC-316	1
2009–11 Ridgeline Front Passenger's Airbag Inflator Kit	04790-SJC-317	04790-SJC-A10 04790-SJC-317	1

#### NOTES

- Replacement inflators with P/Ns that end with 305 and 308 come with shipping insulation wrapped around them. Follow the removal instructions listed in REPAIR PROCEDURE. The insulation is not toxic but some people may be sensitive to it.
- Replacement part numbers may have solid collars or collars with square openings.
- The inflator kit box must be used to return the recalled inflator to its supplier. Be careful not to damage the inflator kit box.
- If the recalled, undeployed inflator is not returned, the warranty claim for that vehicle will be charged back to your dealership.

- To return the undeployed inflators, follow the shipping instructions outlined in PIB A15-0002, *Inflator Kit Return Process* .
- Parts staff can scan the part number and serial number from the outside of the box into the warranty claim by using the Controlled Part Serial No. screen and scanning the applicable information. Refer to the Job Aid **Ordering and Managing Replacement Inflators** for more information.

## WARRANTY CLAIM INFORMATION

### NOTES

- Process claims as quickly as possible so that resources can be properly allocated.
- Enter the part number of the inflator that you received into the warranty claim, **not the part number that you ordered**. For more information, refer to step 6 of REPAIR PROCEDURE.
- To avoid non-payment of warranty claims, the serial number on the box of the new airbag inflator must be entered in the warranty claim. For more information, refer to step 6 of REPAIR PROCEDURE.
- To avoid a warranty claim being charged back to your dealership, you must return the original undeployed inflator to its supplier. Follow the shipping instructions outlined in PIB A15-0002, *Inflator Kit Return Process*.
- The serial number is encoded into the bar code printed on the label inside of the box and on a label attached to the outside of the box. If your dealership uses a scanner, you can scan the serial number from either place into the claim.
- The part number is encoded into a barcode attached to the outside of the box. If your dealership uses a scanner, you can scan the part number into the claim.
- **If you confuse the serial number and part number when entering the claim information**, your claim will automatically be rejected.
- For more information about scanning and filing airbag inflator recall claims, refer to **Ordering and Managing Replacement Inflators**. From the iN, select **Service, Warranty, Warranty Claim**, then **Reference Guide**. Under **HOT TIPS/TOPICS**, select **Inflator Claims at a Glance**.

**Replacing the front passenger's airbag inflator**

Year/Model	Operation Number	Replacement Part Number	Flat Rate Time	Defect Code	Symptom Code	Template ID	Failed Part Number
2005-06 CR-V	7541C2	04790-S9A-305	0.7 hr	6DA00	KA000	A16047A	06780-S9A-A80ZA
		04790-S9A-315	0.7 hr	6DA00	KA000	A16047B	06780-S9A-A80ZA
		04790-S9A-A00	0.7 hr	6DA00	KA000	A16047C	06780-S9A-A80ZA
2003-06 Element	7541C2	04790-SCV-308	0.8 hr	6DA00	KA000	A16047D	06780-SCV-A80ZA
		04790-SCV-318	0.8 hr	6DA00	KA000	A16047E	06780-SCV-A80ZA
		04790-SCV-A10	0.8 hr	6DA00	KA000	A16047F	06780-SCV-A80ZA
2007-11 Element	7541C2	04790-SCV-325	0.9 hr	6DA00	KA000	A16047G	77820-SCV-A91ZA
		04790-SCV-A00	0.9 hr	6DA00	KA000	A16047H	77820-SCV-A91ZA
2007-08 Fit	7541C2	04790-SLN-315	0.7 hr	6DA00	KA000	A16047I	77820-SLN-A81ZA
		04790-SLN-A00	0.7 hr	6DA00	KA000	A16047J	77820-SLN-A81ZA
2002 Odyssey	7541C2	04790-S0X-308	0.7 hr	6DA00	KA100	A16047K	06780-S0X-A70ZA
		04790-S0X-318	0.7 hr	6DA00	KA100	A16047L	06780-S0X-A70ZA
		04790-S0X-A10	0.7 hr	6DA00	KA100	A16047M	06780-S0X-A70ZA
2003-04 Odyssey	7541C2	04790-S0X-305	0.7 hr	6DA00	KA100	A16047N	06780-S0X-A70ZA
		04790-S0X-315	0.7 hr	6DA00	KA100	A16047O	06780-S0X-A70ZA
		04790-S0X-A00	0.7 hr	6DA00	KA100	A16047P	06780-S0X-A70ZA
2003-04 Pilot	7541C2	04790-S9V-308	0.8 hr	6DA00	KA200	A16047Q	06780-S9V-A81ZC
		04790-S9V-318	0.8 hr	6DA00	KA200	A16047R	06780-S9V-A81ZC
		04790-S9V-A10	0.8 hr	6DA00	KA200	A16047S	06780-S9V-A81ZC
2005-08 Pilot	7541C2	04790-S9V-305	0.8 hr	6DA00	KA200	A16047T	06780-S9V-A81ZC
		04790-S9V-315	0.8 hr	6DA00	KA200	A16047U	06780-S9V-A81ZC
		04790-S9V-A00	0.8 hr	6DA00	KA200	A16047V	06780-S9V-A81ZC

2006 Ridgeline	7541C2	04790-SJC-308	0.7 hr	6DA00	KA100	C16047A	77820-SJC-A00ZA
		04790-SJC-318	0.7 hr	6DA00	KA100	C16047B	77820-SJC-A00ZA
		04790-SJC-A20	0.7 hr	6DA00	KA100	C16047C	77820-SJC-A00ZA
2007-08 Ridgeline	7541C2	04790-SJC-316	0.7 hr	6DA00	KA100	C16047D	77820-SJC-A91ZB
		04790-SJC-A00	0.7 hr	6DA00	KA100	C16047E	77820-SJC-A91ZB
2009-11 Ridgeline	7541C2	04790-SJC-317	0.7 hr	6DA00	KA100	C16047F	77820-SJC-A91ZB
		04790-SJC-A10	0.7 hr	6DA00	KA100	C16047G	77820-SJC-A91ZB

Skill Level: Repair Technician

## IDENTIFYING COUNTERFEIT AIRBAGS

This section goes over the steps to identify counterfeit airbags and applies to all vehicles in this service bulletin. It is referred to in each vehicle's repair procedure. Click [HERE](#) to watch a video to help identify counterfeit airbags.

- If there is nothing unusual about the airbag or the inflator, continue with the inflator replacement procedure.
- If there are any unusual markings, like an incorrect label or a model year written in marker, the airbag and inflator may not be the correct airbag and/or inflator for the vehicle or it may be a counterfeit part. For more information about counterfeit airbags, you can refer to [safercar.gov](http://safercar.gov), enter keywords **MANAGING COUNTERFEIT**, and select **Recommended Dealer Guidance for Managing Counterfeit Air Bags** from the list. **If you suspect that the airbag or inflator is counterfeit, do not continue this procedure.** Contact your DPSM for assistance

NON-STANDARD SAFETY LABEL

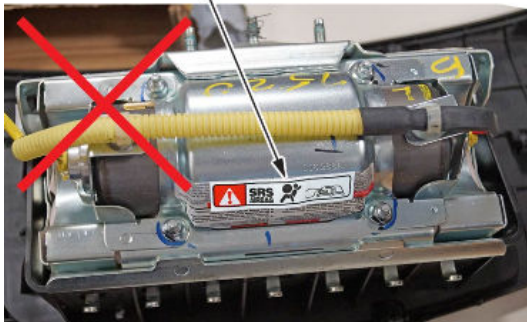

GREASE PENCIL OR PAINT MARKINGS

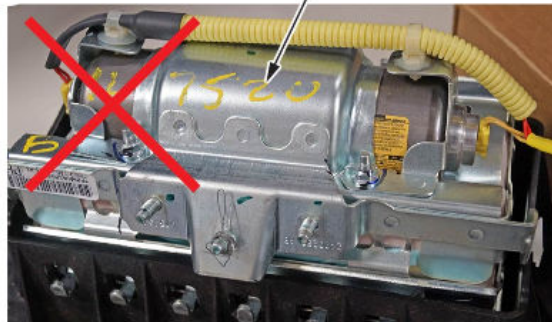

HAND ENGRAVING



NO LABELS ON INFLATOR

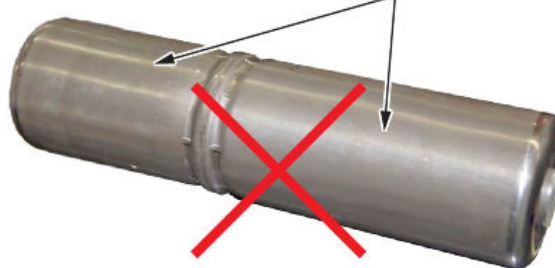

## REPAIR PROCEDURE

### NOTES

- **If the VIN status inquiry indicates that the vehicle is subject to any open safety recalls, including the driver's airbag inflator, make sure to also complete those recall repairs before returning the vehicle to the customer. If you are unable to complete any open recall, advise the customer of the recall status and when the recall could be completed.**
  - Make sure you have the anti-theft code for the audio and navigation system (if applicable), then write down the frequencies for the radio's preset buttons.
  - Be careful not to damage any parts when replacing the inflator, and **follow the procedure exactly**.
  - If, before removing the airbag, you suspect that it may be the incorrect airbag for the vehicle or a counterfeit, **do not remove the airbag**. Contact your DPSM for assistance.
  - Make sure you have reviewed the SRS Precautions and Procedures in the service information before doing the REPAIR PROCEDURE.
1. Turn the ignition switch to the ON (II) position and check if the SRS indicator comes on for about 6 seconds, then turns off.
    - If the indicator comes on, then turns off after about 6 seconds, go to step 2.
    - If the indicator does not come on, or if it stays on, contact your DPSM for assistance.
  2. Disconnect the battery negative cable and wait at least 3 minutes before continuing.
  3. Remove the front passenger's airbag. Refer to the applicable vehicle's service information.

### NOTE

The 2007–11 Element has a one-time use clip you'll have to break to remove the right A-pillar trim.

4. Place the airbag, face-down, on a clean shop towel.

### NOTES

- The orientation of the airbag is critical because if the inflator is installed incorrectly, the harness will be too short when you reinstall the airbag.
- The brackets between the various models are similar but may differ from the example shown.



5. Visually inspect the airbag and the inflator for any unusual writing or markings. Refer to IDENTIFYING COUNTERFEIT AIRBAGS.

6. Peel the label located inside the inflator box from its backing and attach it to the RO. For the warranty claim to be paid, the **replacement inflator part number that you received** must be included in the warranty claim.

**NOTES**

- The replacement part number is printed on the top part of the label and the serial number is printed on the bottom. **Make sure you attach the label to the RO and give it to the warranty clerk .**
- There may also be a colored sticker located in the kit, ignore it because it is not used.
- Not all inflator kits have a label included. In those cases, write the serial number and part number from the side of the inflator box on the RO. The part number always starts with 047.

**PASSENGER INFLATOR PARTS BOX**

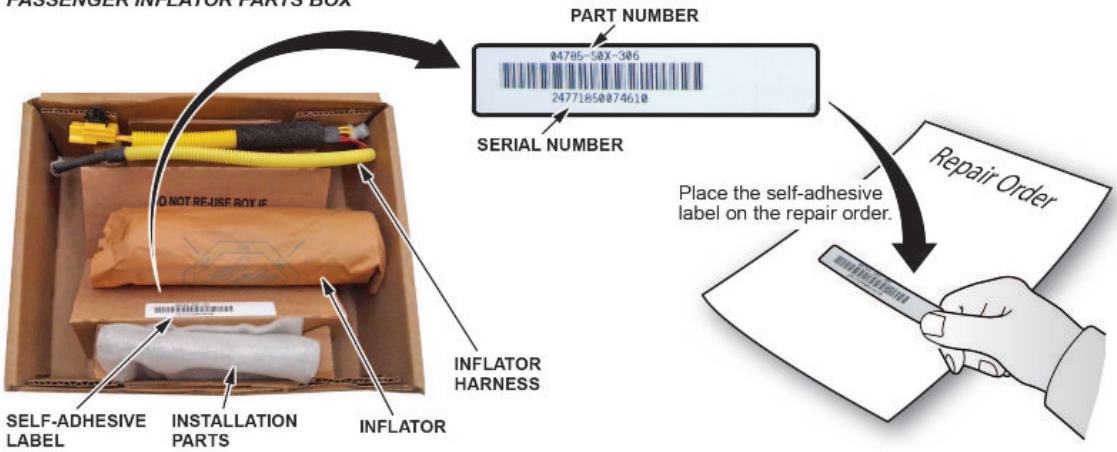

7. Remove the harness from both ends of the inflator bracket.

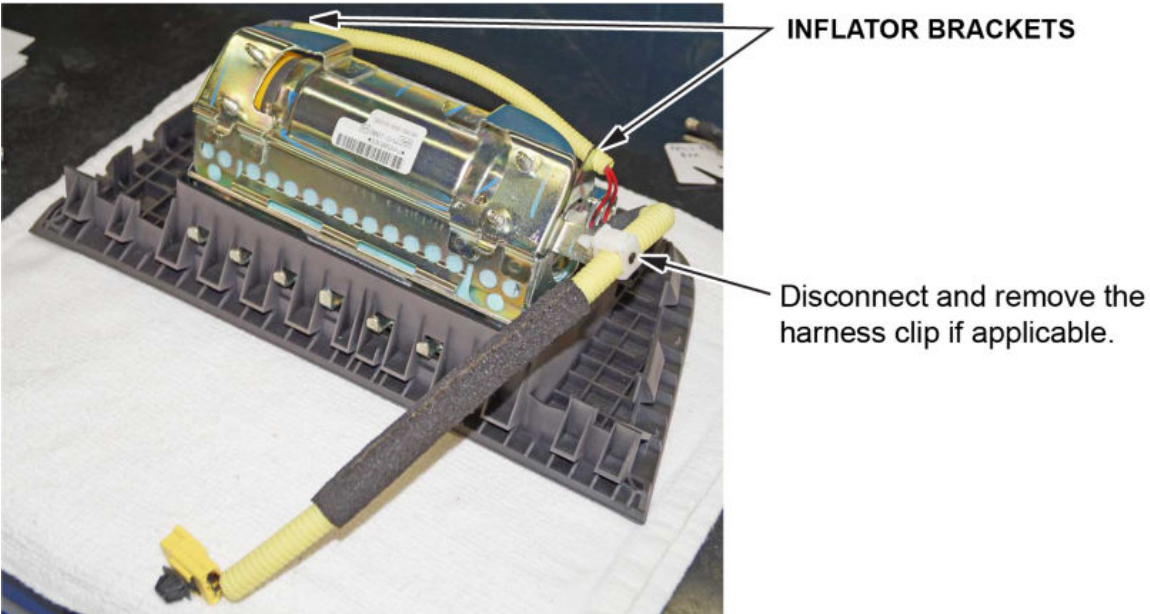

8. Short the red wires.

**NOTE**

**You must cut and short the wires** as indicated to prevent accidental deployment.

8.1. Cut the red wires as shown.

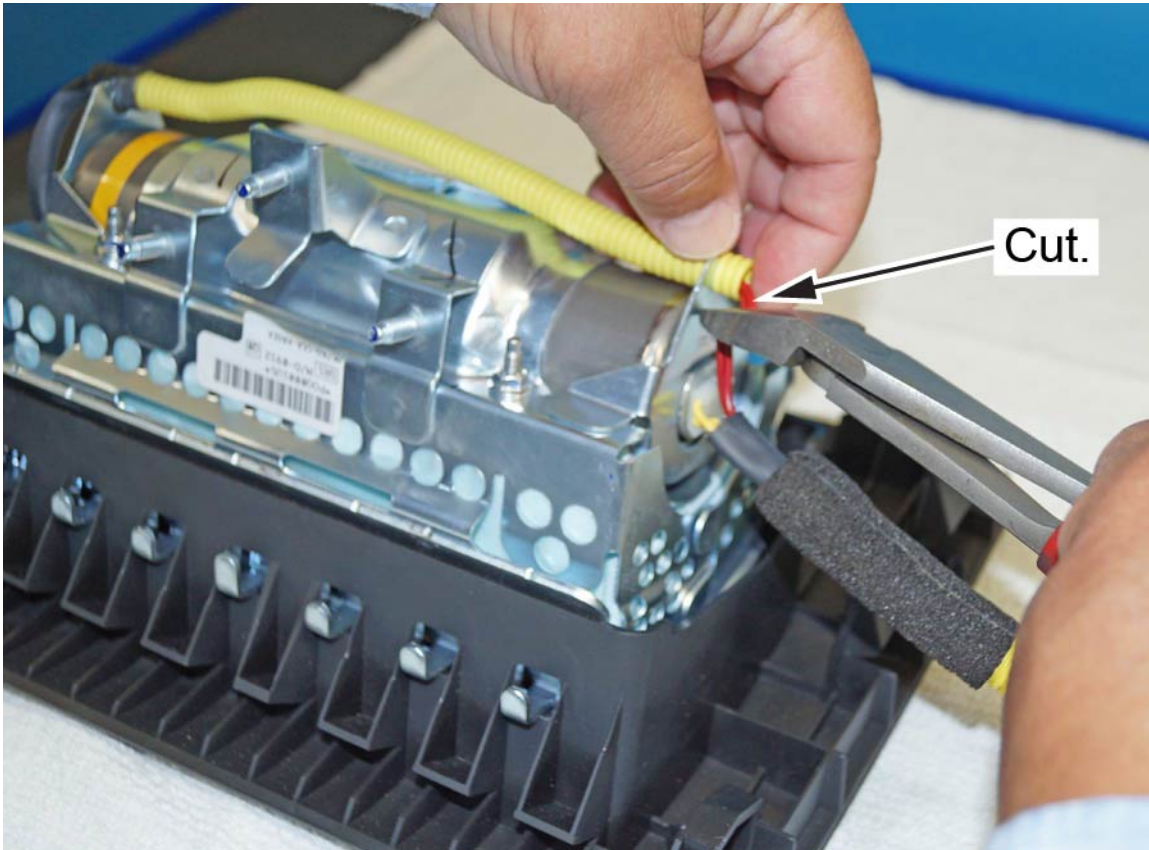

8.2. Cut about 2 inches of the corrugated tube, then pull out the two red wires.

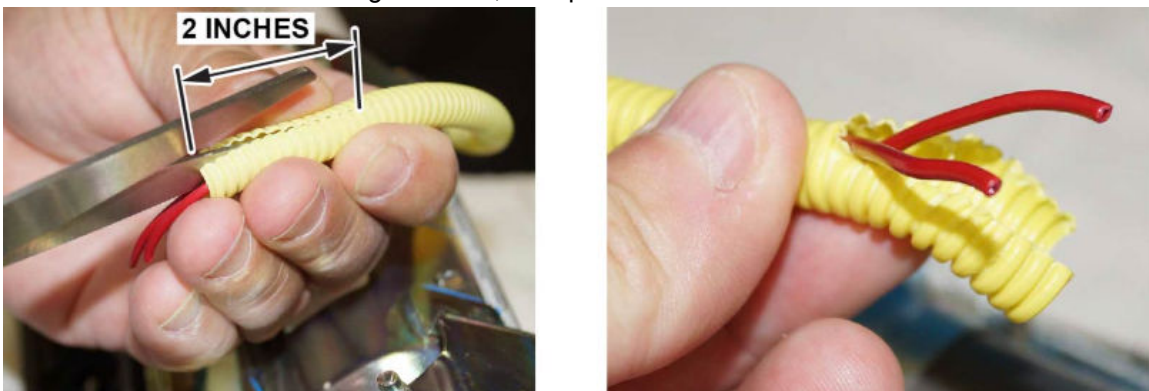

8.3. Strip away about 1 inch of the wire insulation, then twist the wires together.

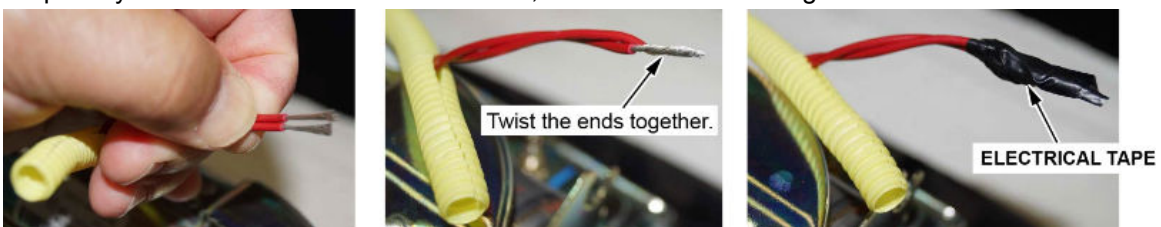

8.4. Tape the twisted ends with electrical tape.

9. Cut off the connector and short the yellow wires.

**You must cut and short the wires as indicated** to prevent accidental deployment.

9.1. Cut all four wires to remove the connector.

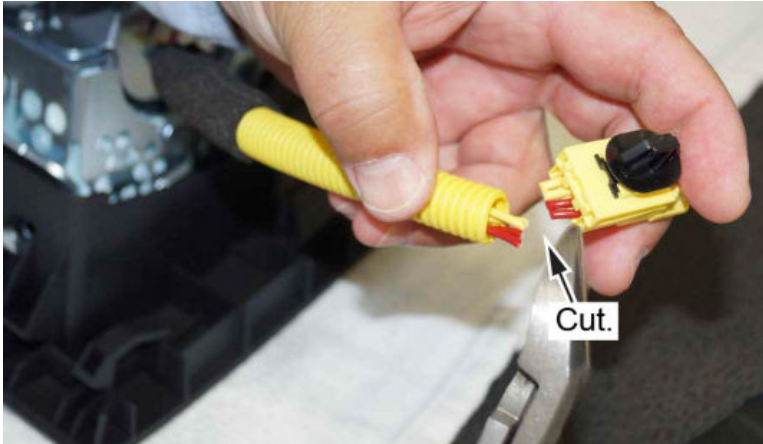

9.2. Cut about 2 inches of the corrugated tube, then pull out the yellow wires.

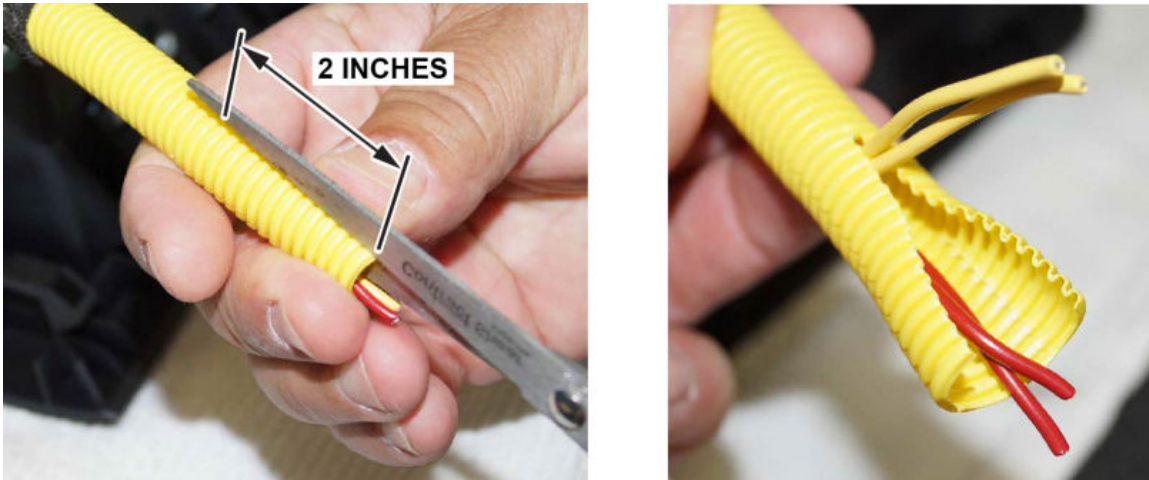

9.3. Strip away about an inch of the wire insulation, then twist the wires together.

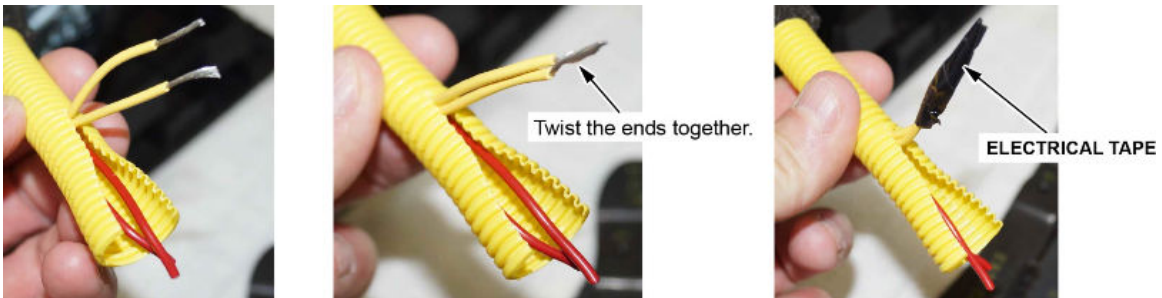

9.4. Tape the twisted ends with electrical tape.

10. Remove the four inflator nuts.

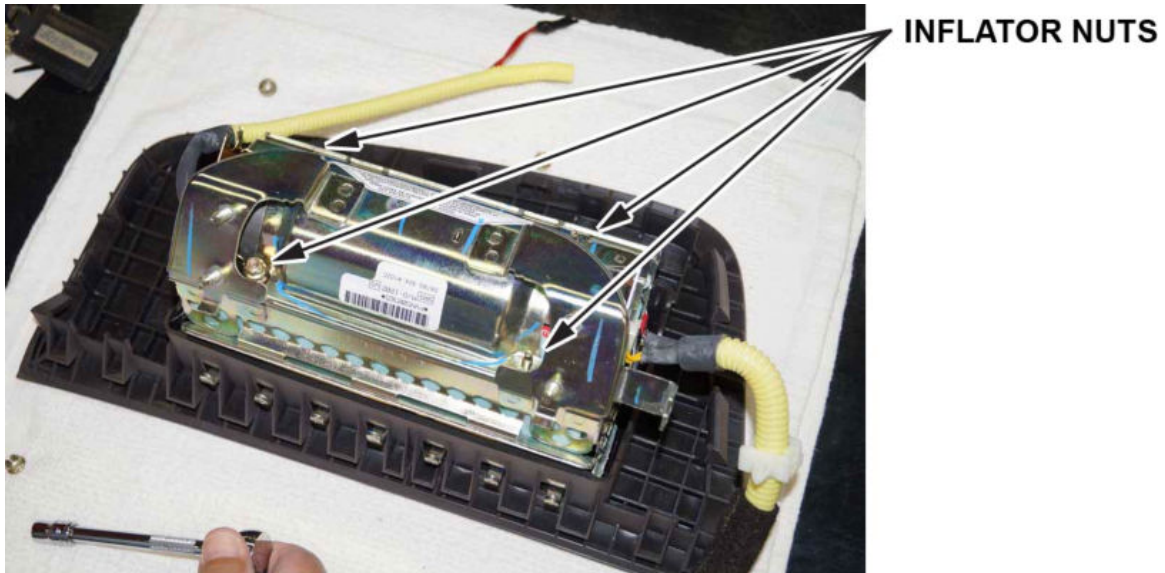

11. Remove the inflator bracket.

**NOTE**

You can only remove one of the brackets, as the other is welded to the airbag housing.

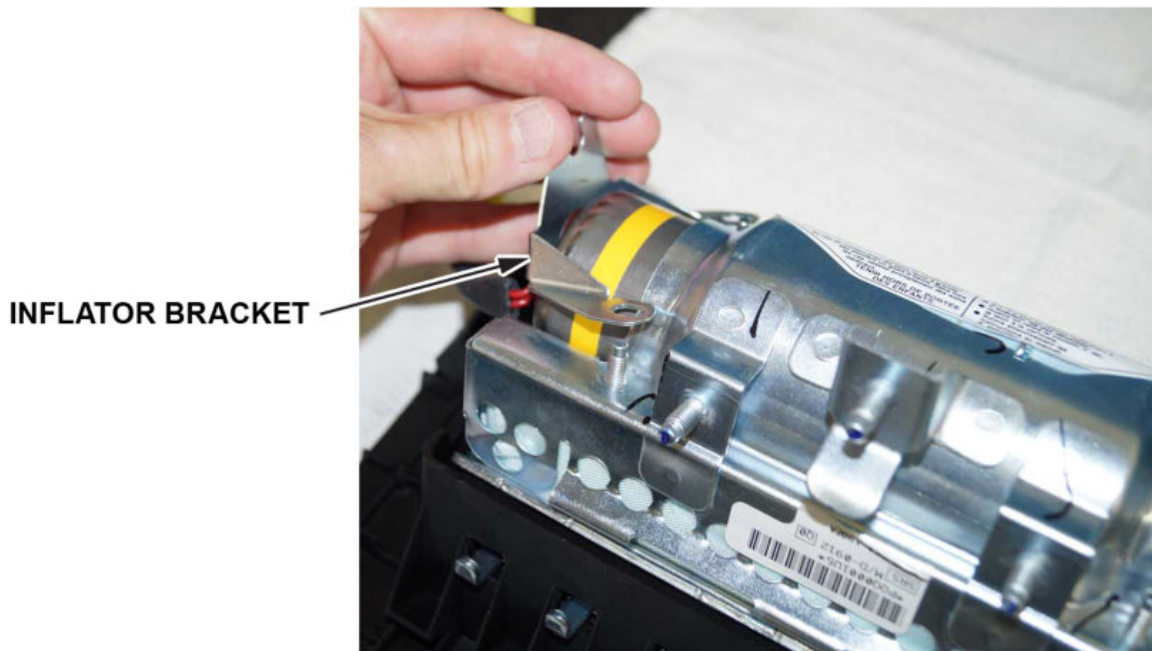

12. Remove the inflator by pushing it out.

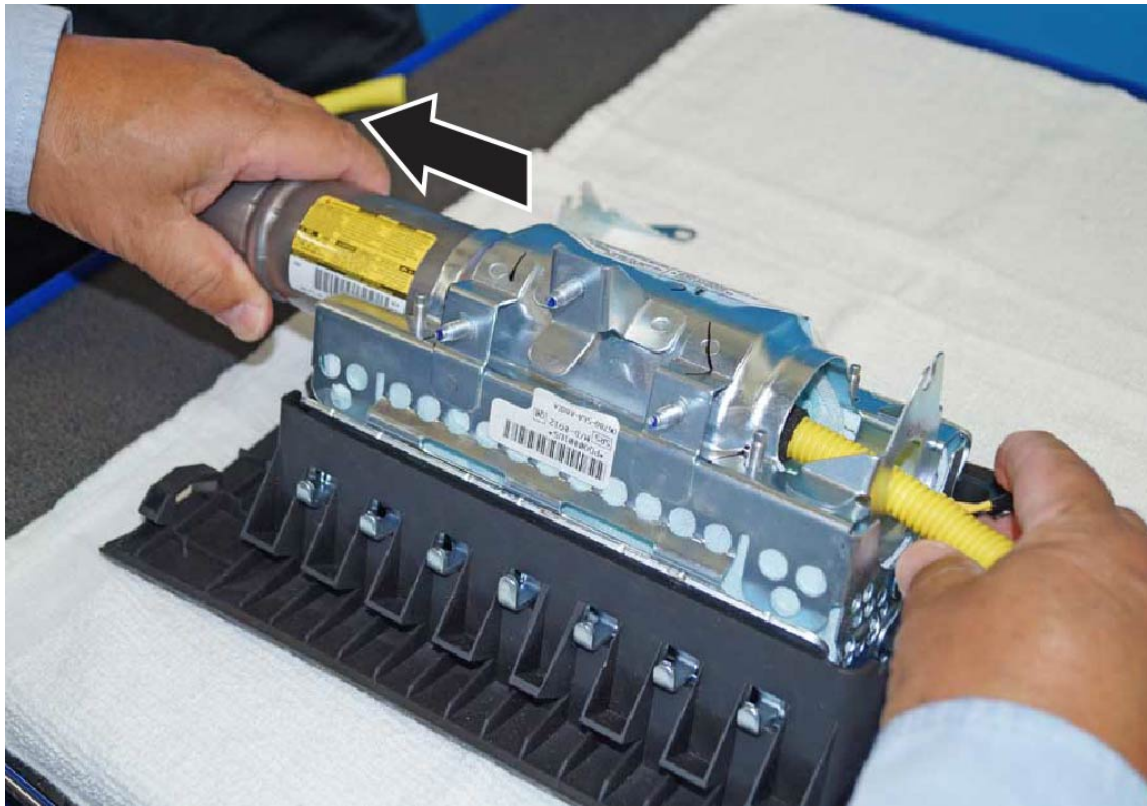

13. Install the new inflator.

**NOTE**

There may be some minor surface rust or corrosion on the new inflator; this is OK.

Click [HERE](#) for a short video about the different variations of the driver's and front passenger's replacement inflators involved with the recalls related to inflators. While both the driver's and front passenger's inflators are shown in the video, this is informational only. Replace inflators only as directed by the iN VIN status inquiry.

13.1. **Check your part number against the ones listed for each installation procedure. Use the correct installation procedure for the part you received.**

**NOTE**

Some parts appear slightly different because they have square openings in the plastic caps.

**Part Number**

04790-SCV-308

04790-SCV-318

**04790-SCV-A10**

04790-S0X-308

04790-S0X-318

**04790-S0X-A10**

04790-S9V-308

04790-S9V-318

**04790-S9V-A10**

04790-SJC-308

**04790-SJC-A20**

13.2. The collars on this inflator are white, not orange. One side of the inflator has a longer collar, a tab, a plastic cutout, and a small flat spot on the connector. The other side of the inflator has a shorter collar, no tab, and a red dot. Make sure you insert the end with the longer collar into the airbag first.

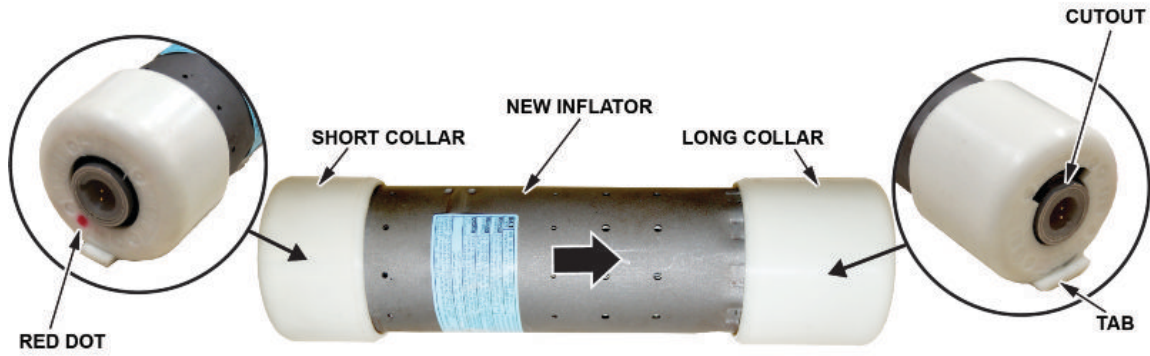

(Some part numbers have solid collars [above] and some part numbers have collars with slots [below])

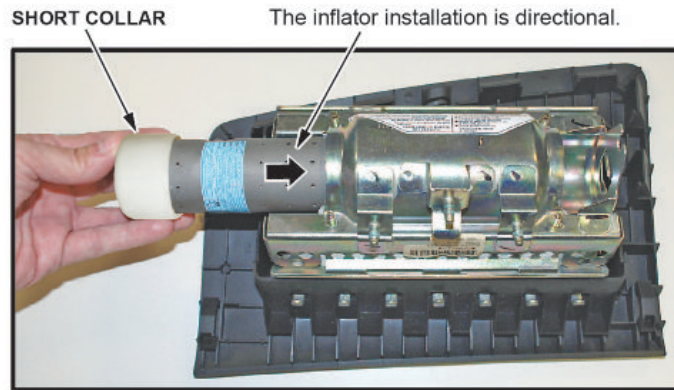
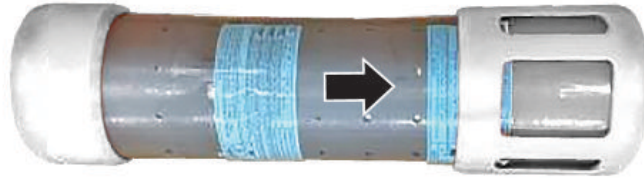

13.3. Slide the inflator in until the plastic cutout and the small flat spot align with the tab on the bracket. There should be no space or gap between the inflator and bracket.

**FIXED BRACKET END**

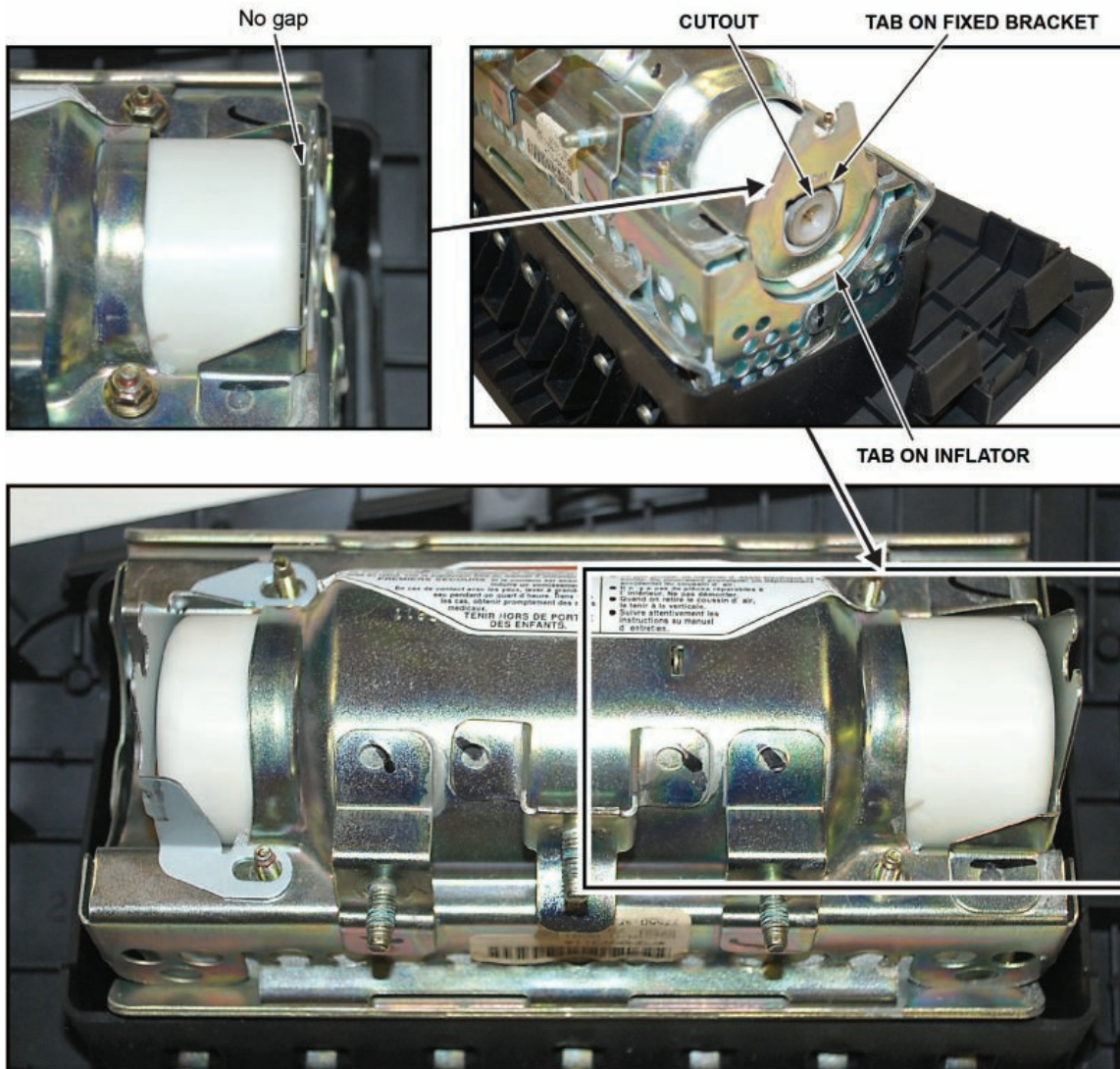

13.4. Install the bracket included in the kit onto the airbag module. There should be a red dot visible on the end of the plastic connector. There should be no space or gap between the inflator and bracket.

**ADJUSTABLE BRACKET END**

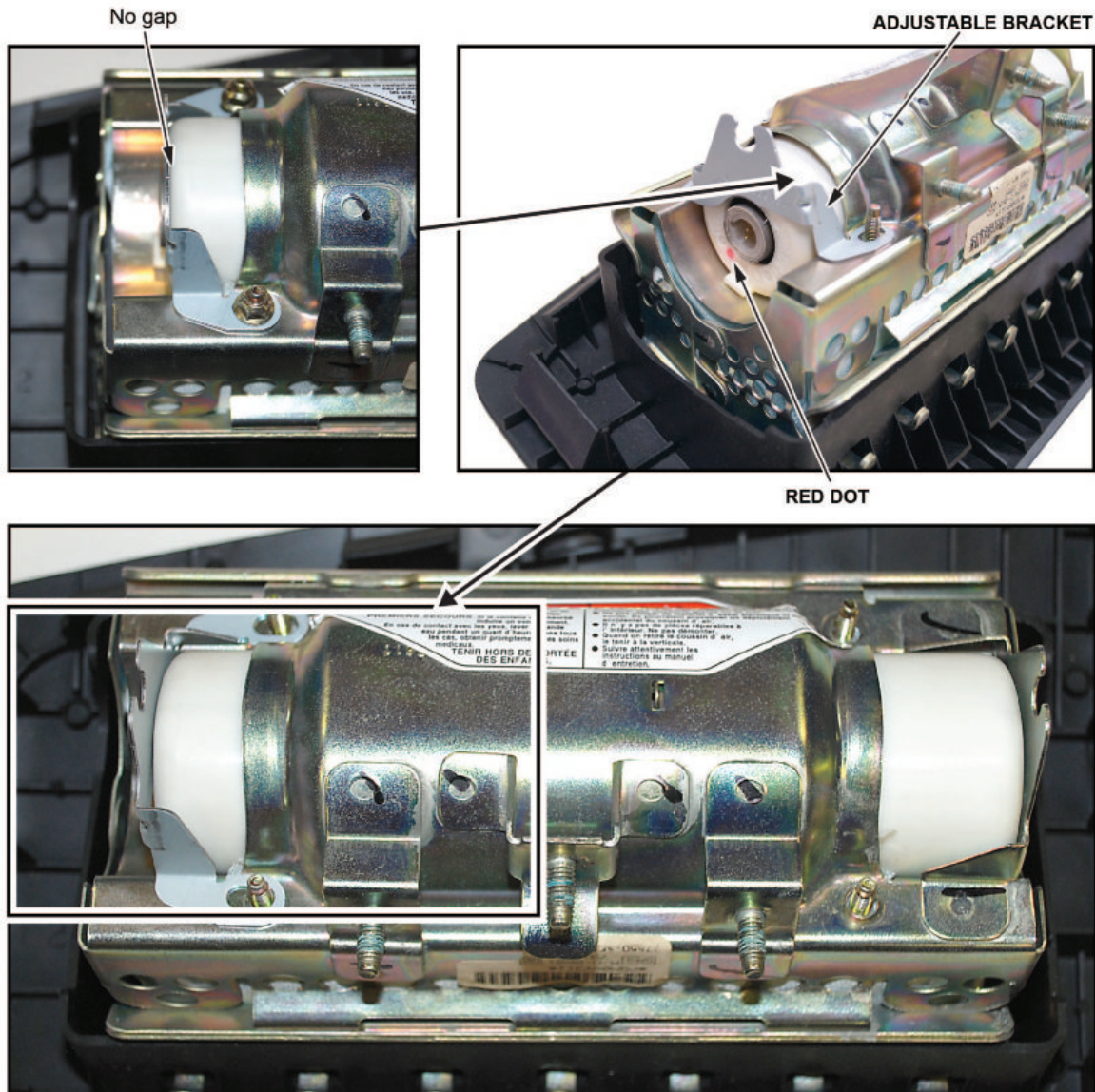

- 13.1. **Check your part number against the ones listed for each installation procedure. Use the correct installation procedure for the part you received.**

#### **NOTES**

- Some parts appear slightly different because they have square openings in the plastic caps.
- If the inflator is wrapped in an insulated sleeve, go to INFLATOR INSULATION REMOVAL for instructions to remove it.

#### **Part Number**

04790-S9A-305

04790-S9A-315

04790-S9A-A00

04790-SCV-325

04790-SCV-A00

04790-SLN-315

04790-SLN-A00

04790-S0X-305

04790-S0X-315

04790-S0X-A00

04790-S9V-305

04790-S9V-315

04790-S9V-A00

04790-SJC-316

04790-SJC-A00

04790-SJC-317

04790-SJC-A10

13.2. Collars on this inflator are orange. One side of the inflator has a longer collar, a tab, a plastic cutout, and a small flat spot on the connector. The other side of the inflator has a shorter collar, no tab, and a red dot. Make sure you insert the end with the longer collar into the airbag first.

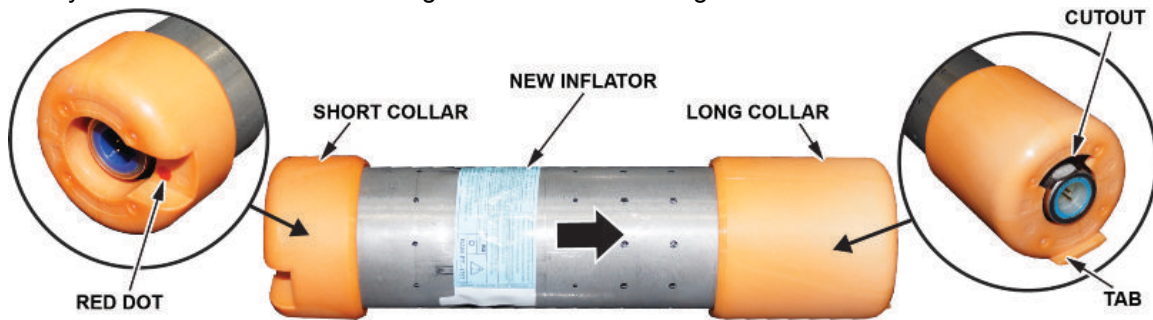

(Some part numbers have solid collars [above] and some part numbers have collars with slots [below])

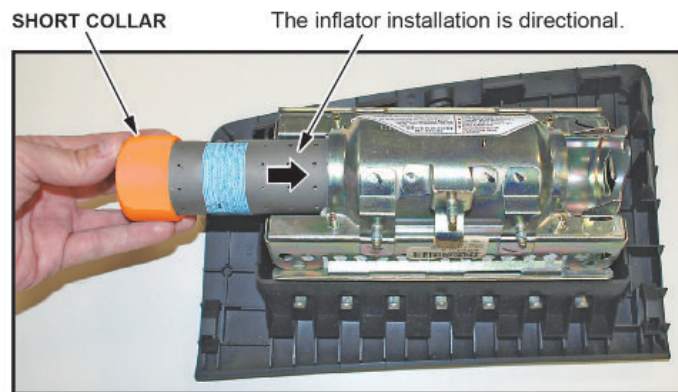
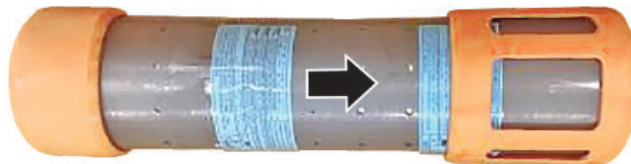

13.3. Slide the inflator in until the plastic cutout and the small flat spot align with the tab on the bracket. There should be no space or gap between the inflator and bracket.

**FIXED BRACKET END**

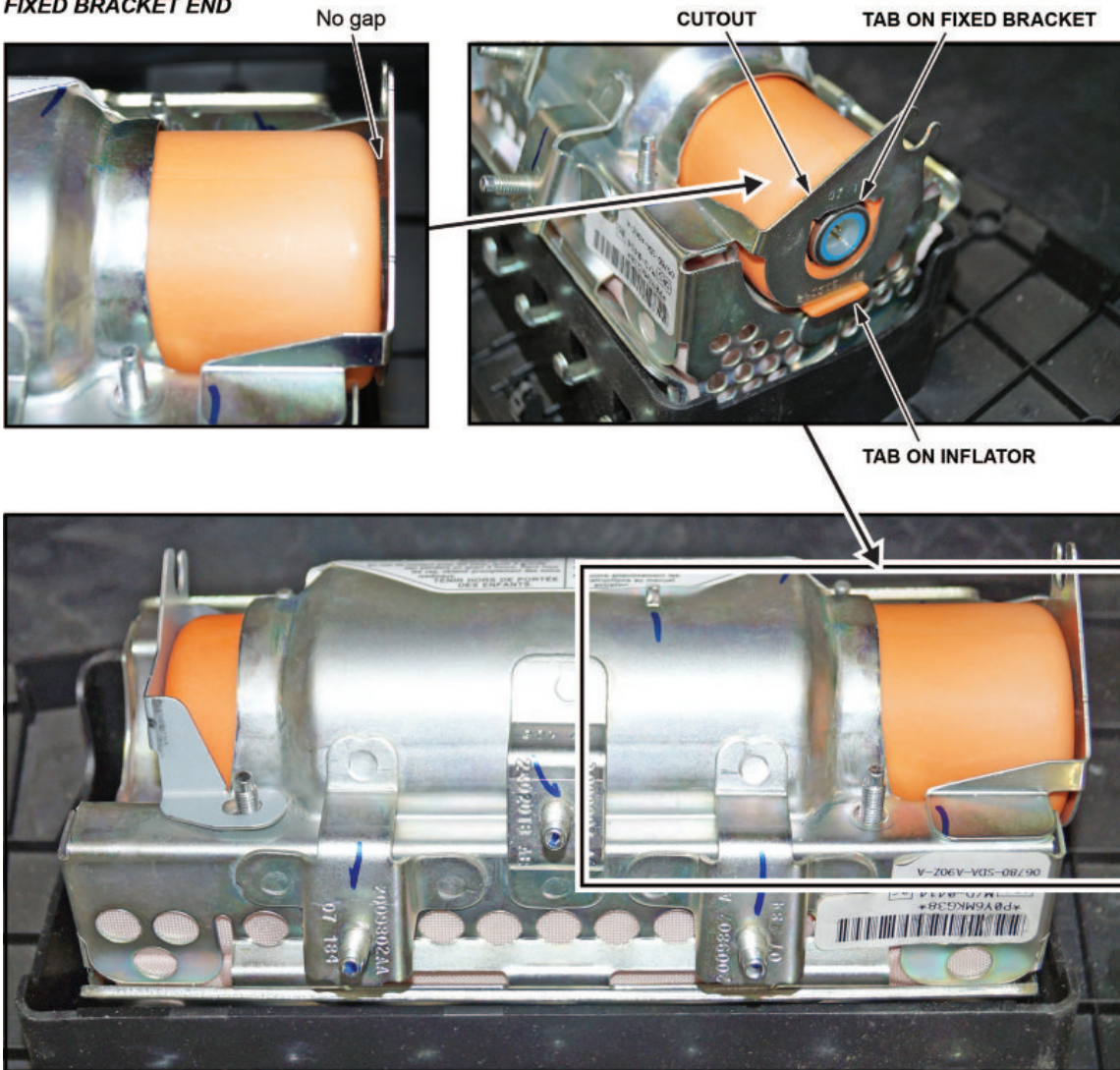

13.4. Install the bracket included in the kit onto the airbag module. There should be a red dot visible on the end of the plastic connector. There should be no space or gap between the inflator and bracket.

**ADJUSTABLE  
BRACKET END**

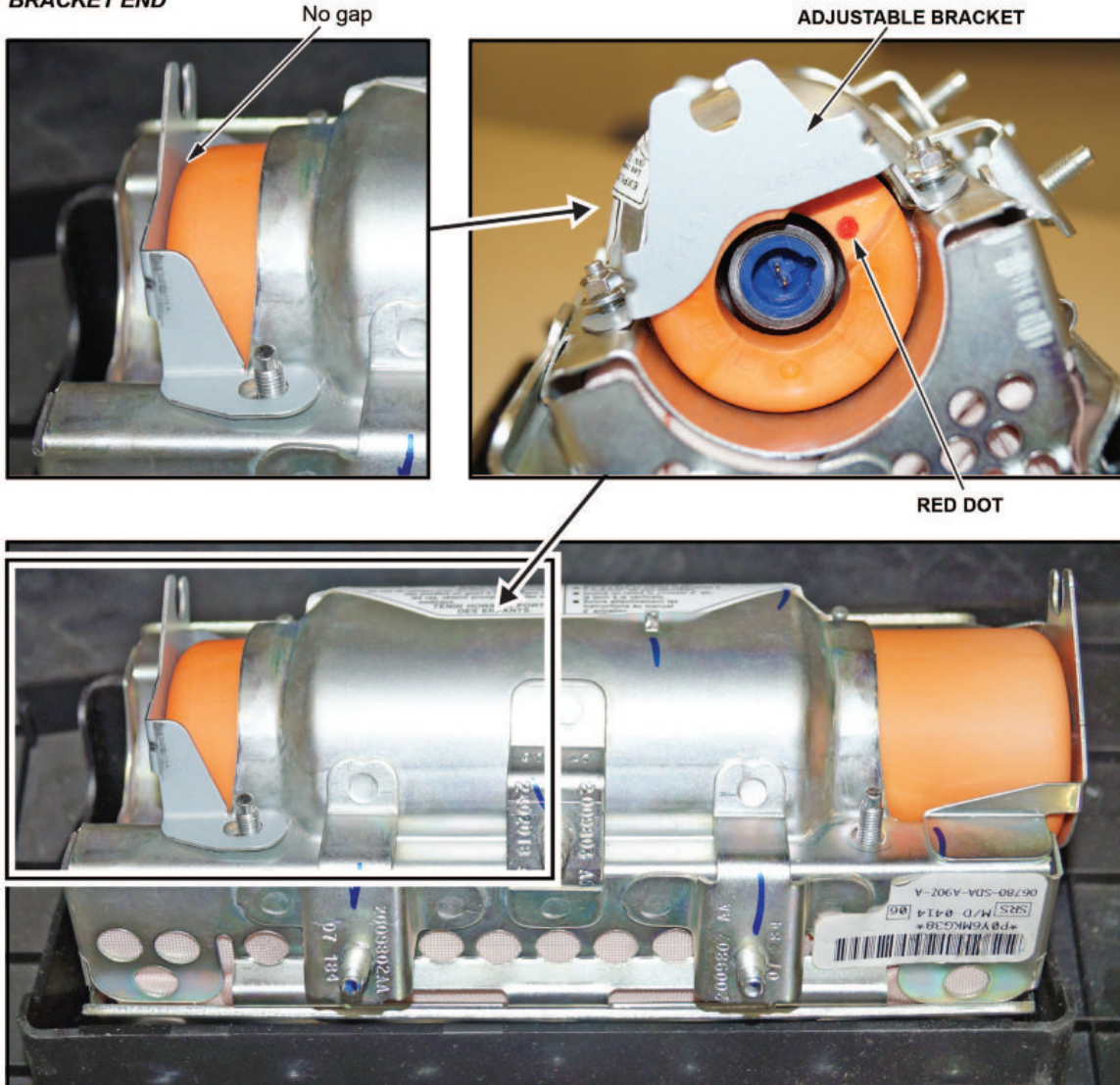

14. Install the new 5 mm locknuts and torque them in sequence to **3.9 N•m (34 lb-in)** .

**LOCK NUTS (4)**  
**3.9 N•m (34 lb-in)**

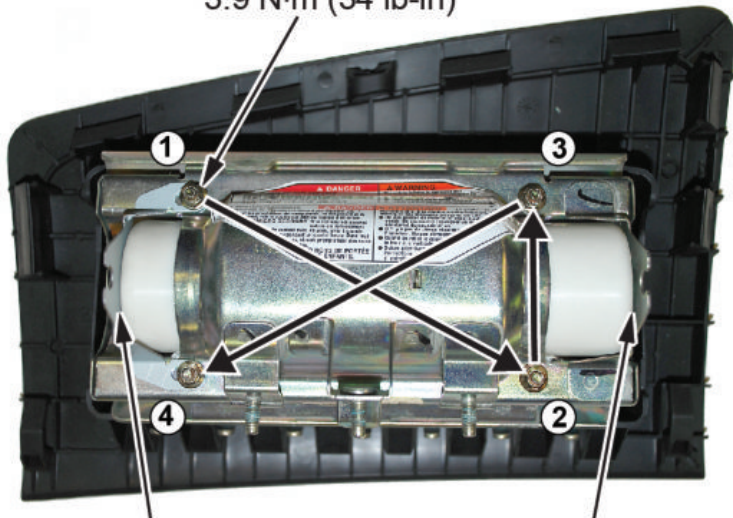

Be sure there are no gaps between the inflator ends and the inflator brackets

15. Remove the stickers covering the terminals on both sides of the new inflator.

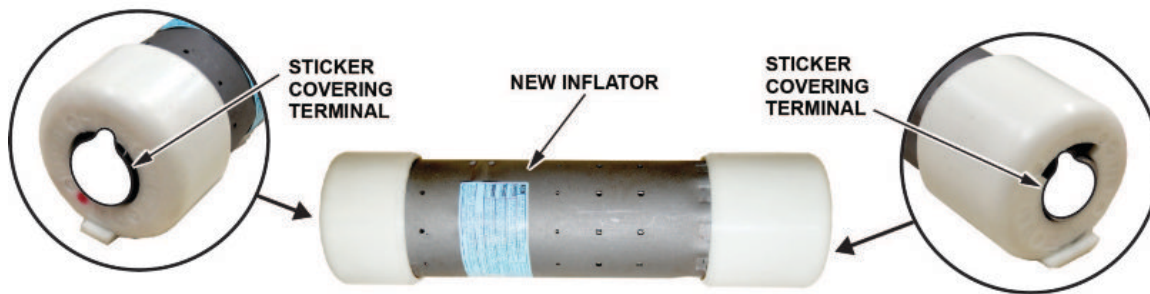

16. Install the new inflator harness.

16.1. Make sure the airbag and harness are aligned as shown.

**NOTES**

- **Make sure you have the orientation correct as shown below.** If you connect the harness incorrectly, the harness cannot be removed, and you will not be able to reinstall the airbag because the harness will be too short.
- Connect the red wire connector to the side of the inflator with the red dot.



16.2. Connect the two connectors. Align the "T" shape in the inflator harness connector with the T-shaped inflator connector, then press the connector into place.

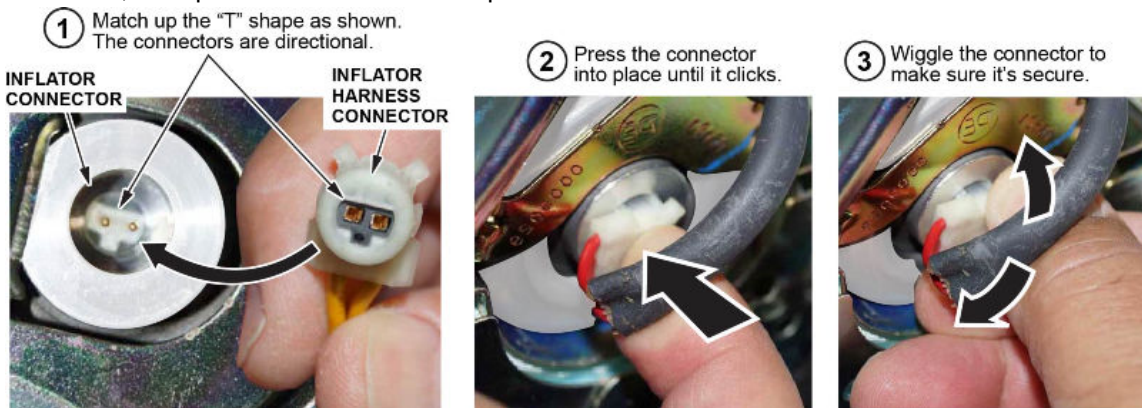

16.3. After you hear each connector click, wiggle it to make sure it is secure.

**NOTE**

If the connector is not properly aligned, it will come out.

17. Connect the harness to the inflator brackets.

17.1. Insert the side without the shrink wrap tubing first. Insert the harness at the third “valley” in the corrugated tube.

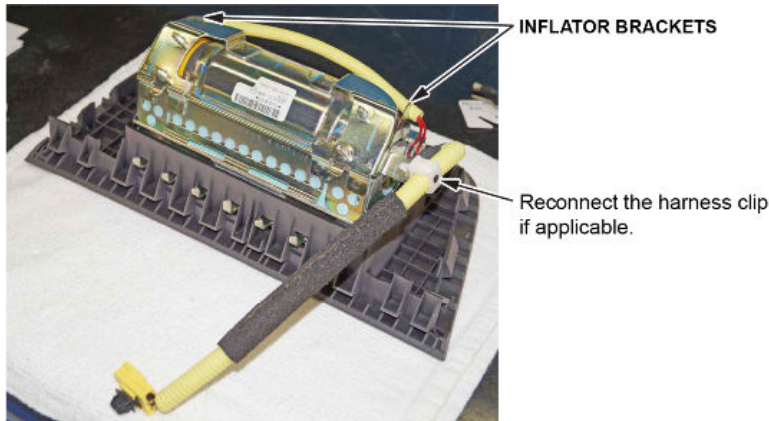

17.2. Insert the side of the harness with the shrink wrap tubing into the inflator bracket. Make sure the harness is securely inserted and that it does not sag.

18. Reinstall the passenger's airbag into the vehicle and torque the new locknuts to **9.8 N•m (7.2 lb-ft)** .

#### NOTES

2007–11 Element only:

- Make sure you reconnect the tweeter (if equipped) before reinstalling the right A-pillar trim.
- Make sure you use the new A-pillar clip included in the kit to reinstall the trim.

19. Reconnect the battery negative cable and enter the anti-theft code for the audio and navigation system (if applicable), then enter the audio presets.

20. Set the clock (for vehicles without navigation).

21. Turn the ignition to ON and make sure the SRS indicator comes on for about 6 seconds, then goes off.

22. **For 2002–04 Odyssey and 2003–04 Pilot:** Do the idle learn procedure.

22.1. Make sure all electrical items (A/C, audio unit, defogger, lights, etc.) are turned off, then start the engine.

22.2. Let the engine reach its normal operating temperature (the cooling fans cycle twice; the coolant temperature is about 194° F).

22.3. Let the engine idle for at least 5 minutes with the throttle fully closed and with all electrical items turned off.

22.4. If the cooling fans cycle on while doing an idle learn, add the time the cooling fans are on to the 5 minute idle learn time.

23. Put the original inflator into the box the new one came in. Make sure there is no other hardware in the box because if the package rattles, it will not be accepted by the courier.

#### NOTE

If the new inflator came with an insulated sleeve, make sure you change the orientation of the cardboard insert so that the original inflator doesn't rattle. See AIRBAG INSULATION REMOVAL for more information.

24. Follow the shipping instructions outlined in PIB A15-0002 to return the undeployed inflator.

25. Give your warranty clerk the RO that includes the replacement inflator serial number and replacement part number. For the warranty claim to be paid, the **replacement inflator part number** must be included in the warranty claim.

## INSULATION REMOVAL

If the replacement inflator is wrapped with shipping insulation, remove it.

### NOTES

- Wear disposable gloves and protective glasses. The insulation is not toxic or dangerous, but some people may be sensitive to the insulation.
  - Dispose of the insulation and wrapping paper to avoid getting the insulation dust/fibers on you or the airbag assembly.
  - Do not reuse the insulation or wrapping paper. You do not need to wrap the inflator being removed from the vehicle when it is returned.
1. Cut the wires off from the opposite side from where they are tied (twisted) together.

### NOTE

Do not cut the insulation.

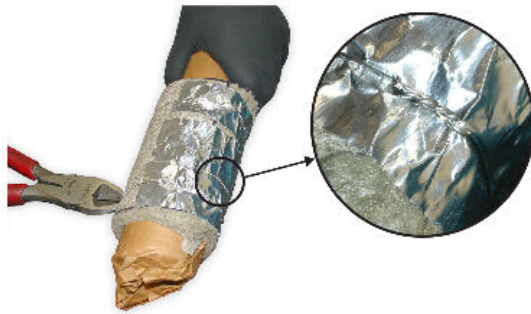

2. Hold the paper wrapping the inflator with one hand and slide the insulation off into the trash.

### NOTE

The insulation is securely wrapped around the inflator. You may have to use some force to slide the insulation off. Do not cut the insulation and be careful that you do not move the white or orange plastic ends.



3. Remove the wrapping paper and drop it into the trash.



4. To return the original inflator, remove the cardboard insert and turn it 90 degrees. Then insert the cardboard into the slots as shown.

#### NOTES

- **Do not reuse the shipping insulation.**
- The cardboard insert needs to be adjusted to send back the original inflator otherwise the original inflator removed from the vehicle will rattle around and may be rejected by the courier.

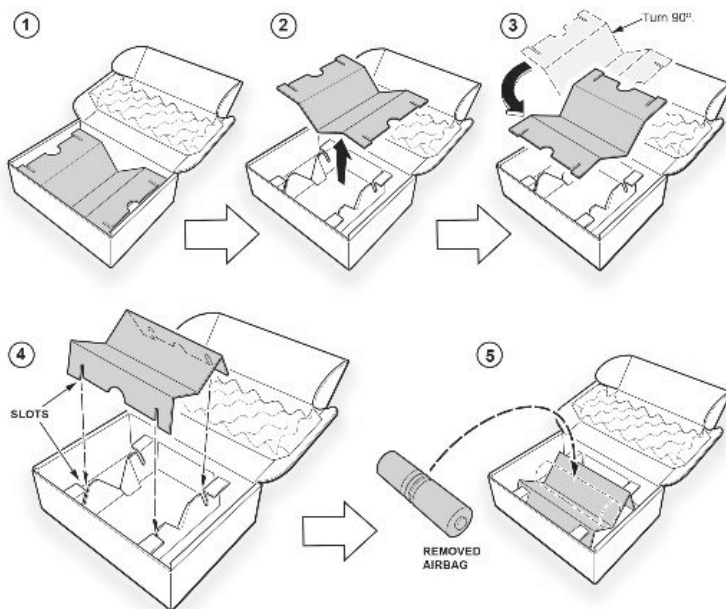

END