

**TECHNICAL INSTRUCTIONS**  
**FOR**  
**CAMPAIGN G0C**  
**CENTER AIRBAG SENSOR ASSEMBLY (SRS ECU)**  
**CERTAIN 2005 – 2006 MY TUNDRA**

**Updated 11-21-17**

**Update 11-21-17**

- **Updated parts information**

**Update 03-24-17**

- **Part information added and additional safety warnings**

The repair quality of covered vehicles is extremely important to Toyota. All dealership technicians performing this repair are required to successfully complete the most current version of the E-Learning course “Safety Recall and Service Campaign Essentials”. To ensure that all vehicles have the repair performed correctly; technicians performing this repair are required to currently hold at least one of the following certification levels:

- **Toyota Expert Electrical**
- **Master Technician**
- **Master Diagnostic Technician**

Always check which technicians can perform the recall remedy by logging on to <https://www.uotdealerreports.com>. It is the dealership’s responsibility to select technicians with the above certification level or greater to perform this repair. Carefully review your resources, the technician skill level, and ability before assigning technicians to this repair. It is important to consider technician days off and vacation schedules to ensure there are properly trained technicians available to perform this repair at all times.

## I. OPERATION FLOW CHART

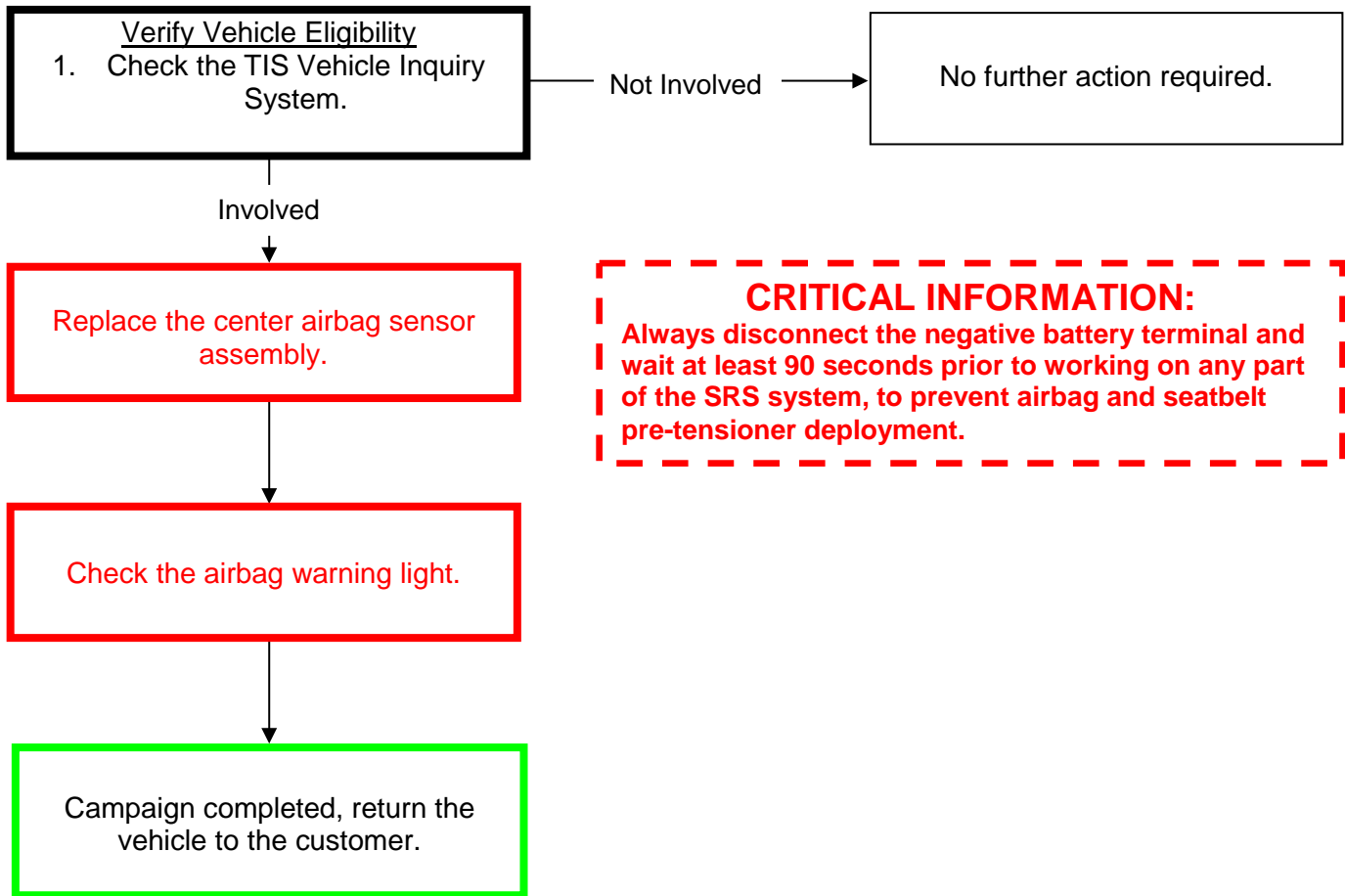

## II. IDENTIFICATION OF AFFECTED VEHICLES

- Check the TIS Vehicle Inquiry System to confirm the VIN is involved in this SSC and that the campaign has not already been completed prior to dealer shipment or by another dealer.
- TMS warranty will not reimburse dealers for repairs conducted on vehicles that are not affected or were completed by another dealer.

## III. PREPARATION

### A. PARTS

**NOTE:** Only one Air bag sensor is needed per vehicle. To determine which part number to order, input the VIN into the following website: <https://q0c-qlb-parts-lookup.imagespm.info/>. Default password is xxxxx.

### B. TOOLS & EQUIPMENT

- Techstream
- Molding Remover Set
- Torque Wrench
- Standard Hand Tools

#### IV. BACKGROUND

The subject vehicles are equipped with side Curtain-Shield-Airbags (CSAs) which deploy from the roof rails in the event of certain types of crashes. Due to improper programming in the airbag control module, there is a possibility that, under certain specific and limited conditions shortly after vehicle startup, the CSAs and seat belt pre-tensioners could activate when not necessary. Unexpected activation of the CSAs could increase the risk of injury to the occupant.

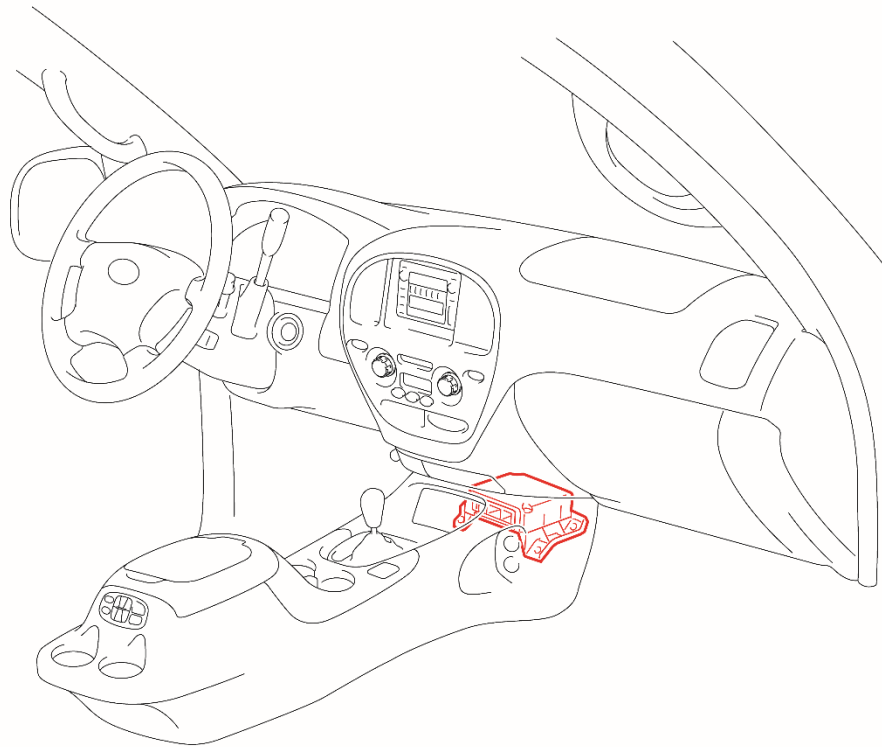

K1500260064a

## V. SAFETY PRECAUTIONS

**STOP**

### CRITICAL INFORMATION – READ THOROUGHLY

**STOP**

Failure to follow these procedures correctly could cause the SRS to unexpectedly deploy during servicing or the SRS may fail to operate correctly when required after reassembly. Confirm all work is performed safely as described in the following Technical Instructions.

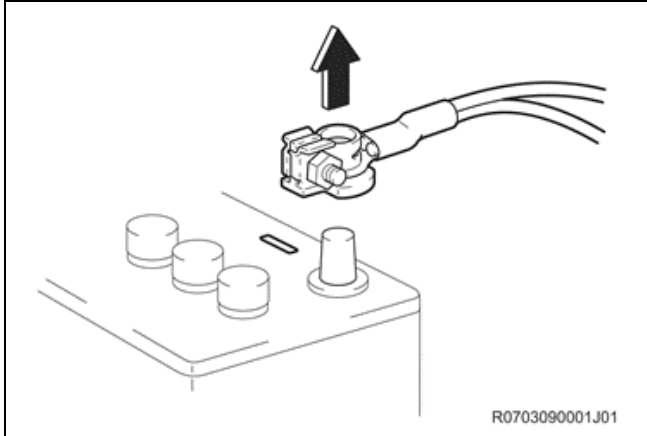

#### 1. DISCONNECT THE BATTERY TERMINAL

**STOP**

- Always disconnect the negative terminal and wait 90 seconds before performing work to prevent airbag and seatbelt pre-tensioner deployment due to back-up battery supply.

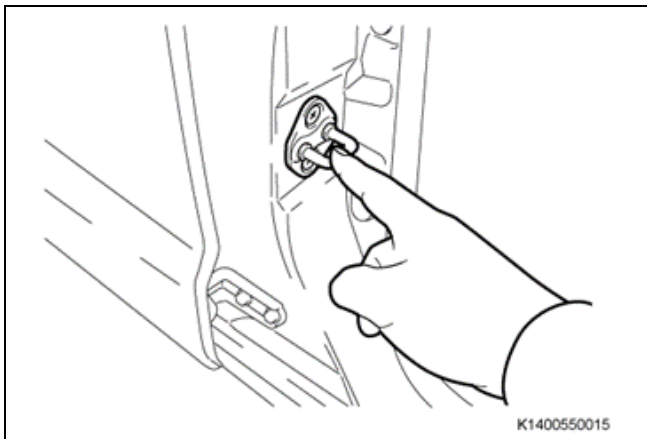

#### 2. ELIMINATE STATIC ELECTRICITY

- a) Before removing ECU ground yourself by touching a metallic part of the vehicle.



#### 3. DO NOT DROP THE CENTER AIRBAG SENSOR

**NOTE: DO NOT** use power or pneumatic tools to remove the fasteners that secure the sensor to the vehicle.

## VI. REPLACING THE CENTER AIRBAG SENSOR (SRS ECU)

### 1. PERFORM HEALTH CHECK

- Check to verify if there any air bag DTC's present (current, history, or pending).



This campaign only covers the replacement of the Airbag Sensor Assembly (SRS ECU). No further components in the SRS system are covered by this campaign.

### 2. RECORD AND DOCUMENT CUSTOMERS VEHICLE SETTINGS

### 3. DISCONNECT THE NEGATIVE BATTERY TERMINAL



- Wait at least 90 seconds after disconnecting the cable from the negative battery terminal to prevent airbag and seat belt pre-tensioner deployment.
- Follow all precautions as outlined on TIS before servicing the SRS system.

### 4. COMPONENTS INVOLVED IN THE REMOVAL OF THE CENTER AIRBAG SENSOR (SRS ECU)

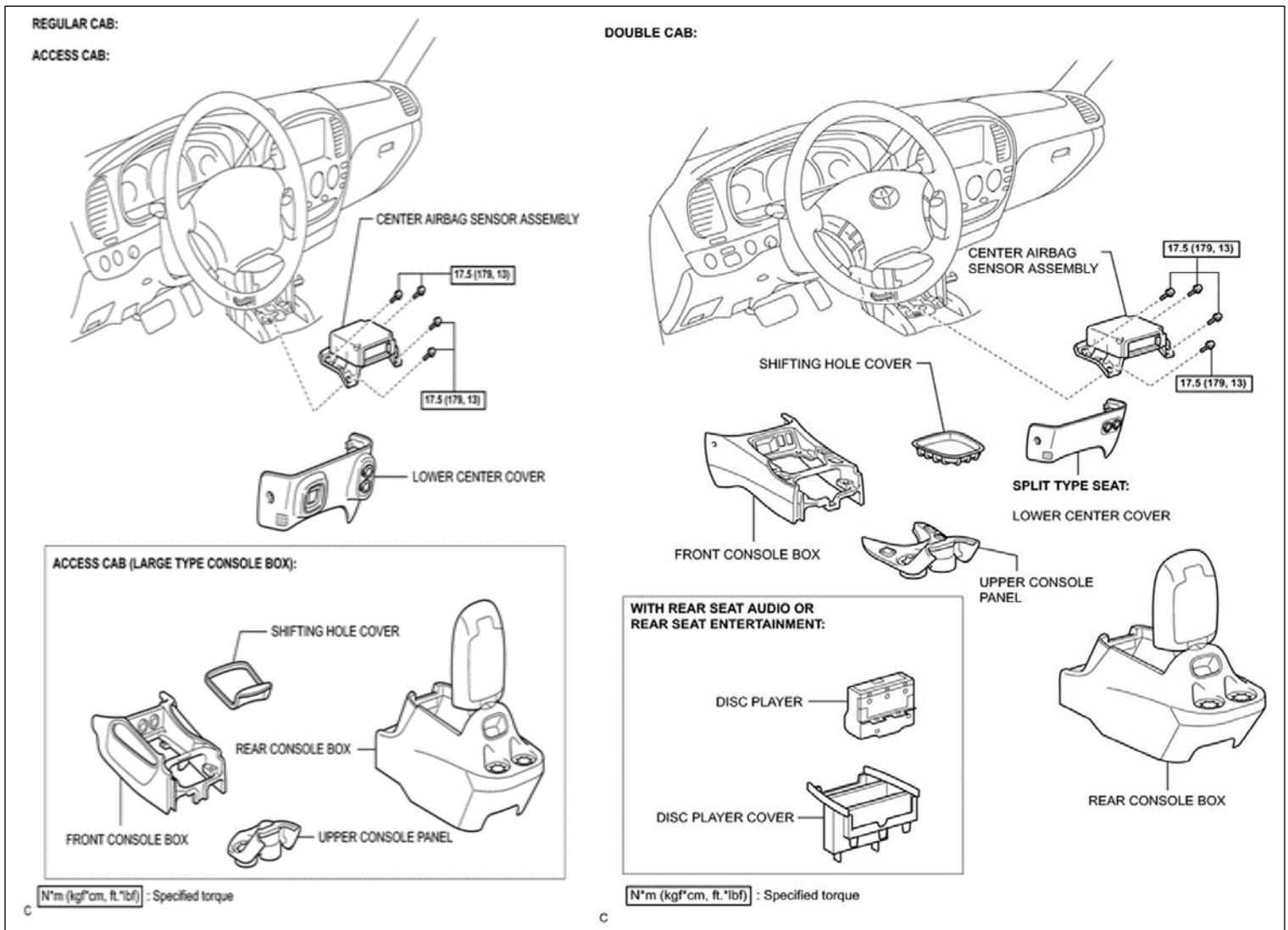

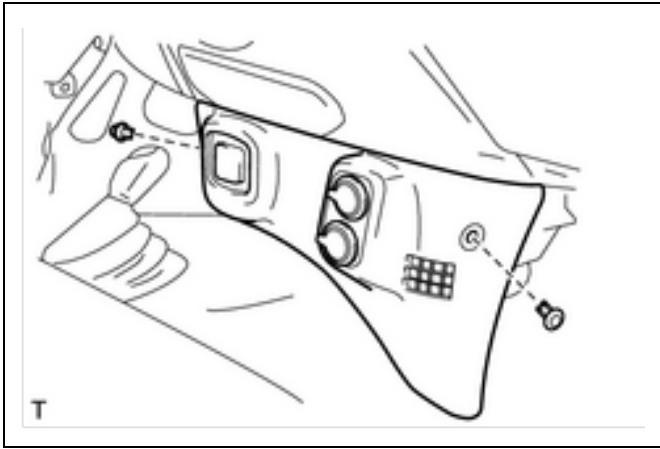

**5. REMOVE LOWER CENTER COVER**

- a) Remove the 2 clips and lower center cover.
- b) Disconnect the connectors.

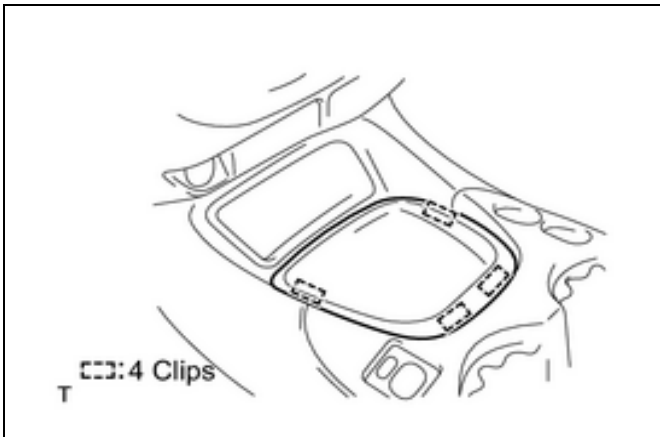

**6. REMOVE SHIFTING HOLE COVER**

- a) Using a screwdriver, disengage the 4 clips and remove the shifting hole cover.

**NOTE:** Tape the screwdriver tip before use.

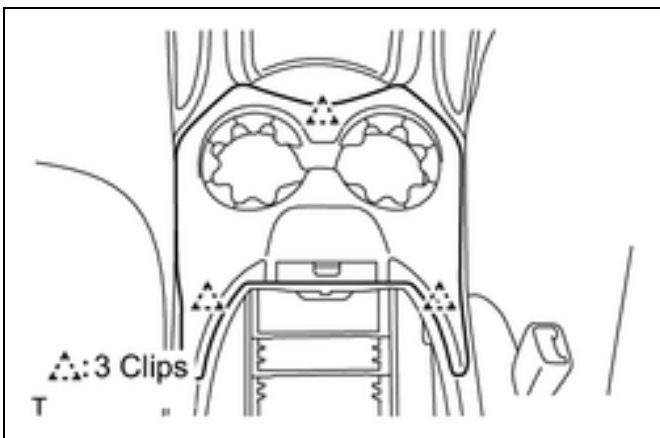

**7. REMOVE CONSOLE PANEL UPPER**

- a) Using a screwdriver, disengage the 3 clips and remove the console panel upper.

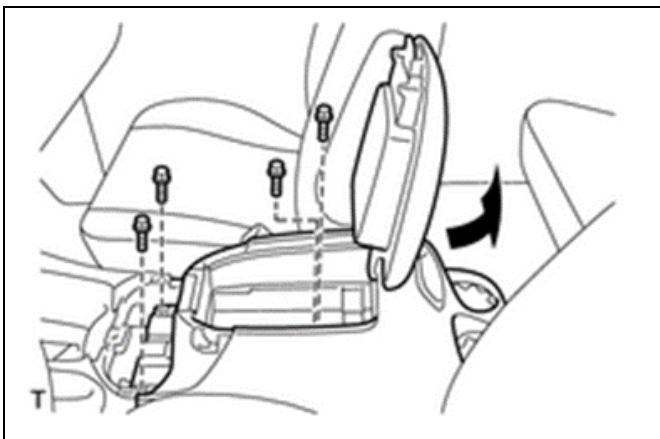

**8. REMOVE CONSOLE REAR END PANEL**

- a) Remove the 4 bolts and No. 2 console rear end panel.

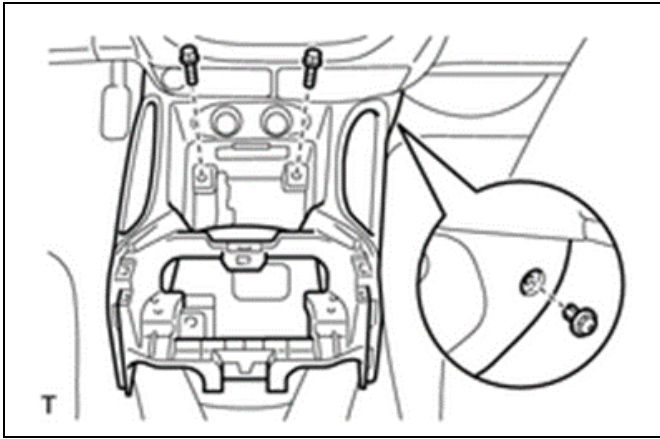

**9. REMOVE FRONT CONSOLE BOX (Access Cab W/ Large Type Console Box)**

- a) Remove the 2 bolts, clip and the front console box.
- b) Disconnect the connector.

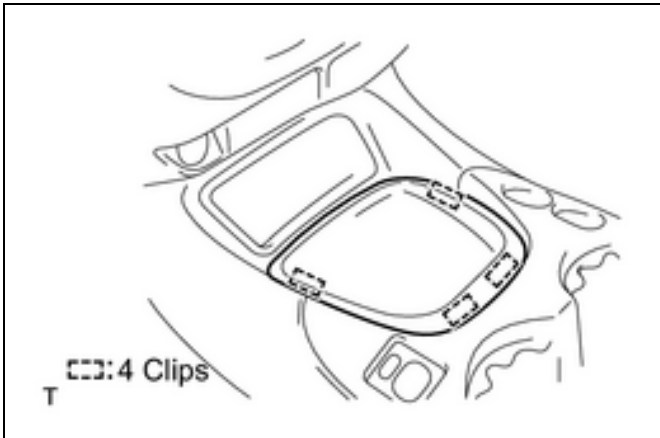

**10. REMOVE SHIFTING HOLE COVER (Double Cab)**

- a) Using a screwdriver, disengage the 4 clips and remove the shifting hole cover.

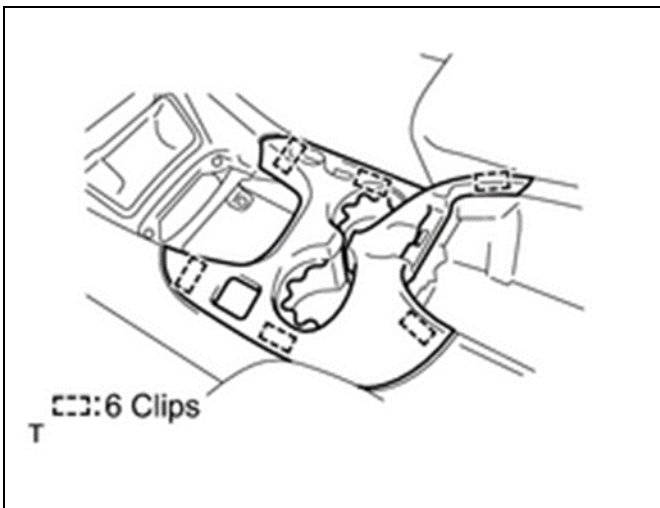

**11. REMOVE UPPER CONSOLE PANEL (Double Cab)**

- a) W/ Seat heater:
  - 1) Using a screwdriver, remove the seat heater switches, then disconnect the connectors.
  - 2) Using a screwdriver, remove the power mirror control switch, then disconnect the connector.
  - 3) Using a screwdriver, disengage the 6 clips and remove the upper console panel.



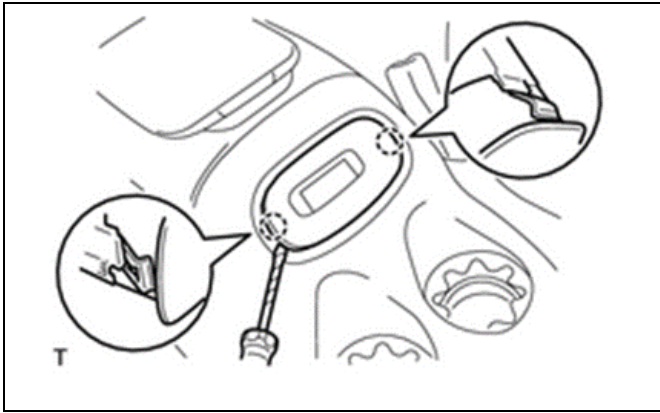

## 12. REMOVE REAR CONSOLE BOX (Double Cab)

- a) W/ VTR control garnish:
- 1) Using a screwdriver, disengage the 2 claws and remove the VTR control garnish and connector
  - 2) Disconnect the connector.

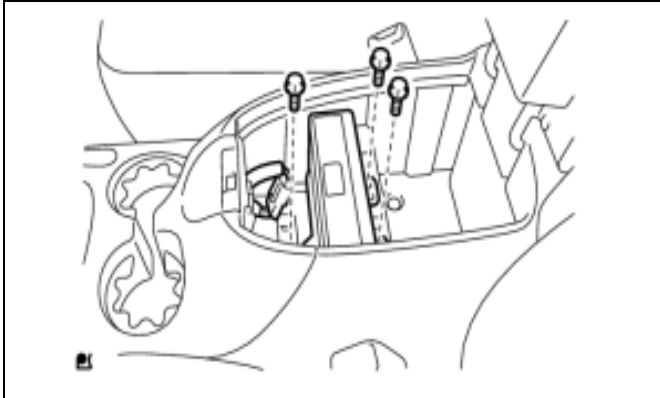

## 13. REMOVE REAR CONSOLE BOX (Double Cab)

- a) W/ rear seat entertainment
- 1) Remove the disc bracket.
  - 2) Remove the 3 bolts and disc player.
  - 3) Disconnect the connector.
  - 4) Remove the 4 bolts and rear console box.

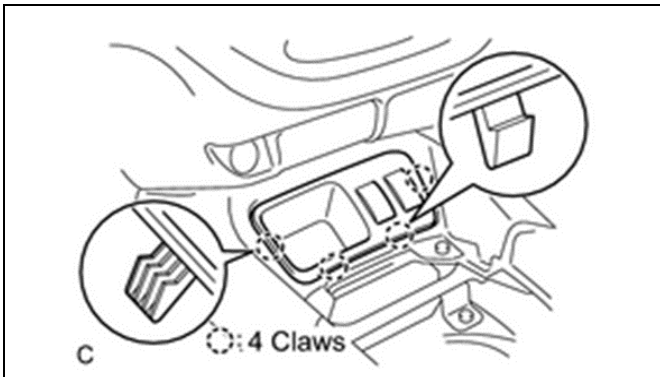

## 14. REMOVE CONSOLE BOX POCKET (Double Cab)

- a) Using a screwdriver, disengage the 4 claws.
- b) Disconnect the connectors and remove the console box pocket.

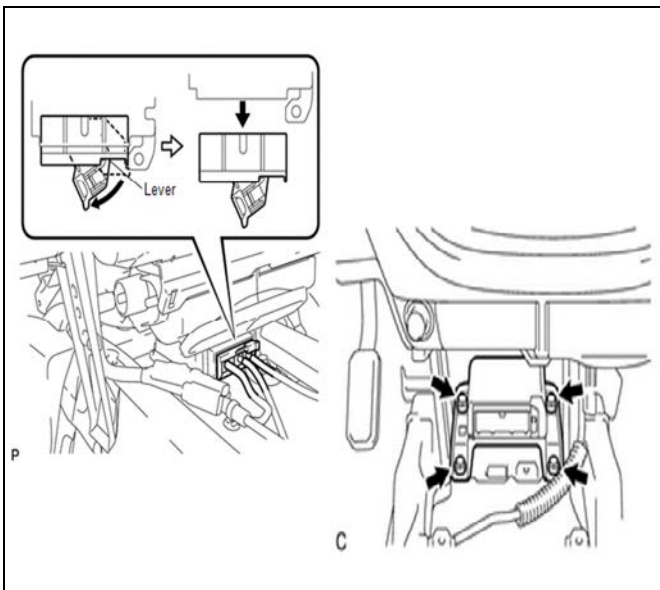

## 15. REMOVE THE CENTER AIRBAG SENSOR



- Confirm that the negative battery terminal is disconnected before performing the operation. Even an impact to only the airbag sensor will cause the airbag to deploy.
- Wait at least 90 seconds after disconnecting the negative battery terminal to prevent airbag and seat belt pre-tensioner deployment.

- a) Pull the lever and detach the connector holder.
- b) Remove the 3 bolts and remove the airbag sensor.

**NOTE: DO NOT use power or pneumatic tools to remove the fasteners that secure the sensor to the vehicle.**



## VII. INSTALLATION OF THE NEW CENTER AIRBAG SENSOR

### 1. INSTALL THE NEW CENTER AIRBAG SENSOR

- a) Check that the ignition switch is off.

**NOTE:** Verify that the campaign p/n and the sensor p/n match up. Always order the 04006-xxxxx p/n for vehicles covered by this campaign.

Campaign PN	Sensor PN
04006-2310C	89170-0C222
04006-2320C	89170-0C262

**DO NOT** use power or pneumatic tools to install the fasteners that secure the sensor to the vehicle.

- b) Install the center airbag sensor with the 4 bolts.  
c) Tighten the 3 bolts to the specified torque.

**Torque:**

**17.5 N•m {179 kgf•cm, 13ft•lbf}**

- d) Connect the holder (with connectors) to the center airbag sensor.  
e) Check that the waterproof sheet is properly set.

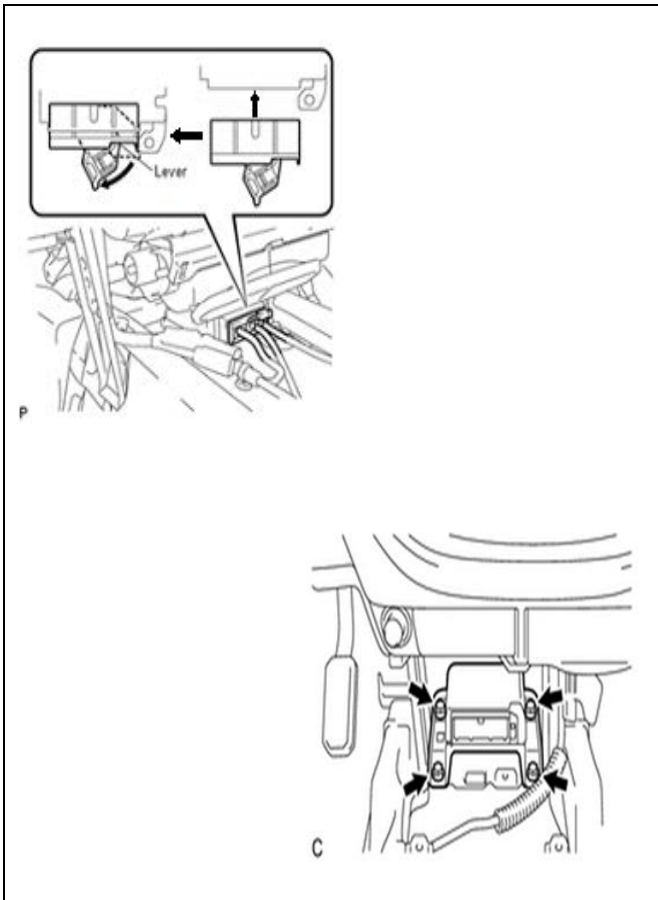

### 2. REINSTALL CONSOLE BOX POCKET (Double Cab)

- a) Reconnect the connectors.  
b) Engage the 4 claws and reinstall the console box pocket.

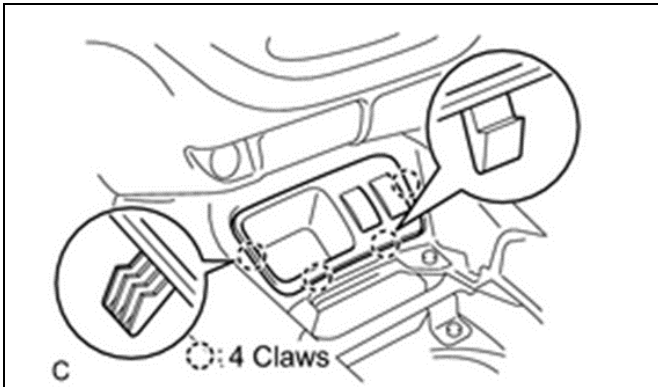

### 3. REINSTALL REAR CONSOLE BOX

- a) With rear seat entertainment:
- 1) Reinstall the disc bracket.
  - 2) Reconnect the connector.
  - 3) Reinstall the 3 bolts and disc player.
  - 4) Reinstall the 4 bolts and rear console box.

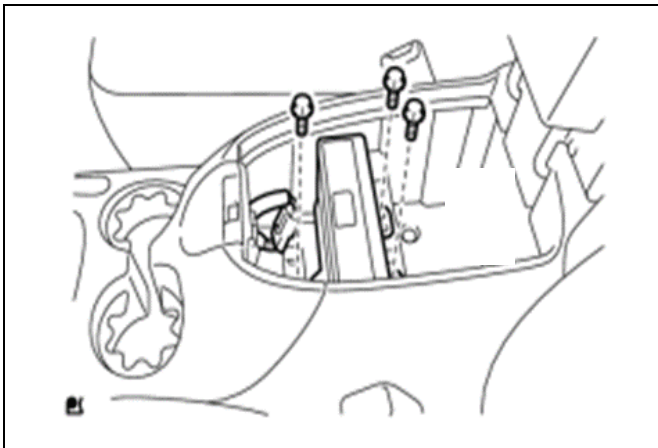

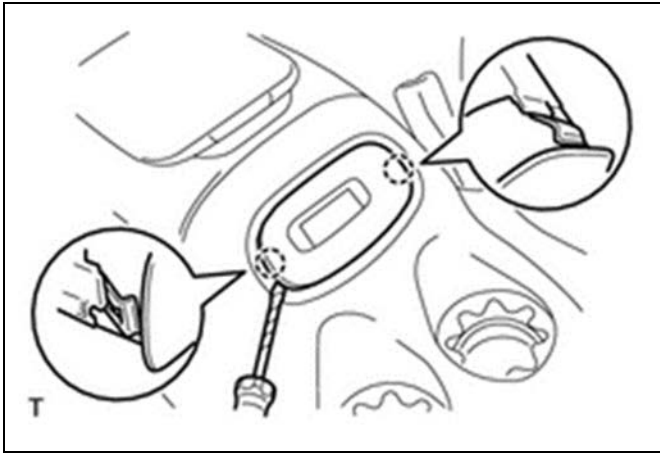

#### 4. REINSTALL REAR CONSOLE BOX (Double Cab)

- a) W/ VTR control garnish:
  - 1) Reconnect the connector.
  - 2) Engage the 2 claws and reinstall the VTR control garnish and connector

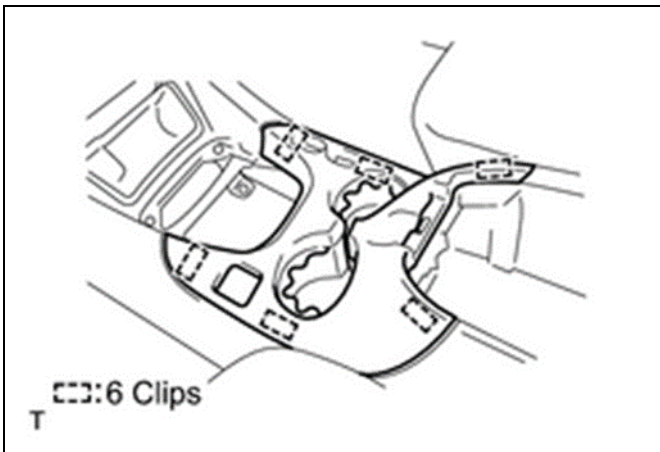

#### 5. REINSTALL UPPER CONSOLE PANEL (Double Cab)

- a) W/ Seat heater:
  - 1) Reconnect the connectors, then reinstall the seat heater switches.
  - 2) Reconnect the connector, then reinstall the power mirror control switch.
  - 3) Engage the 6 clips and reinstall the upper console panel.

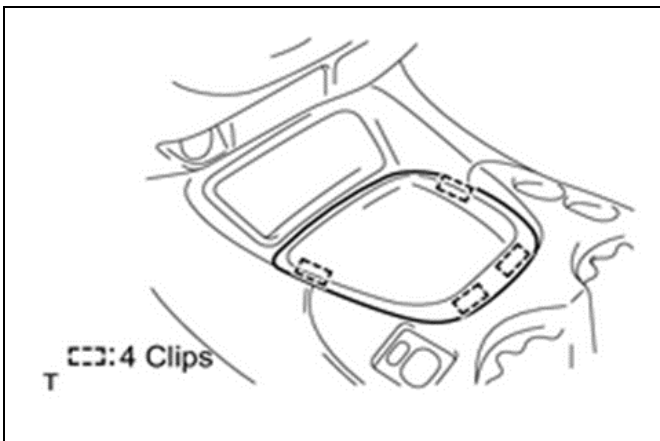

#### 6. REINSTALL SHIFTING HOLE COVER

- a) Engage the 4 clips and reinstall the shifting hole cover.

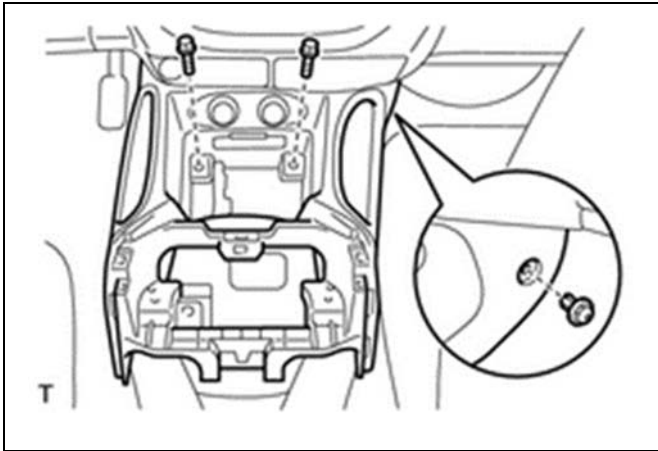

**7. REINSTALL FRONT CONSOLE BOX (Access Cab W/ Large Type Console Box)**

- a) Reconnect the connector.
- b) Reinstall the 2 bolts, clip and the front console box.

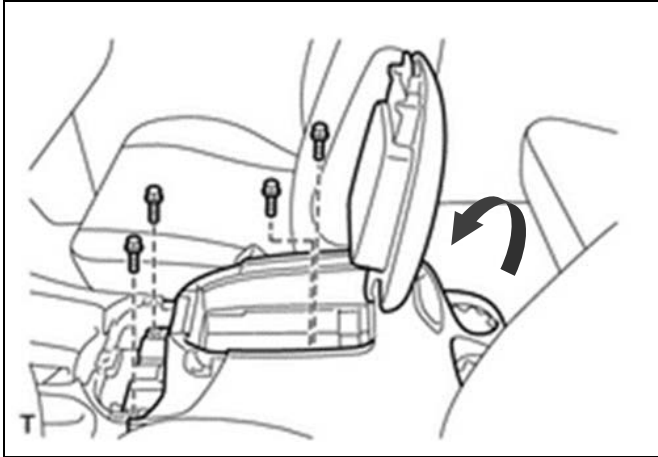

**8. REINSTALL CONSOLE REAR END PANEL**

- a) Reinstall the 4 bolts and No. 2 console rear end panel.

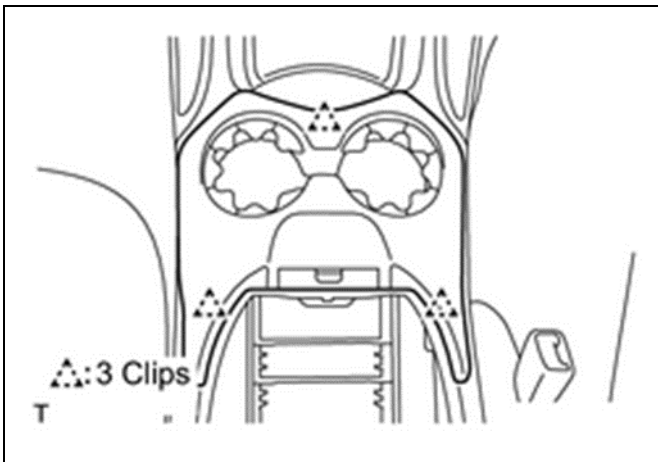

**9. REINSTALL CONSOLE PANEL UPPER**

- a) Engage the 3 clips and reinstall the console panel upper.

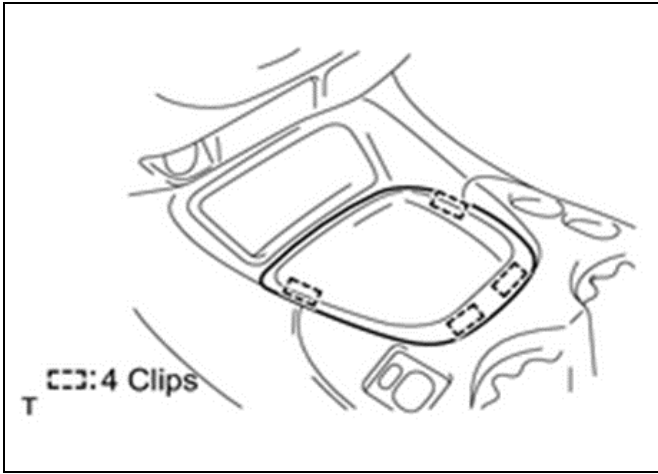

**10. REINSTALL SHIFTING HOLE COVER**

- a) Engage the 4 clips and reinstall the shifting hole cover.

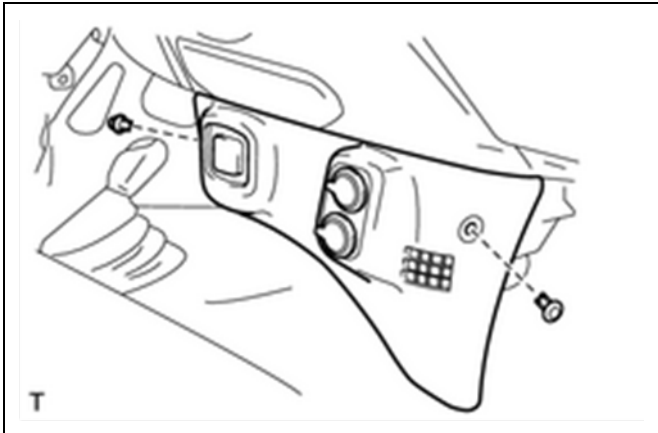

**11. REINSTALL LOWER CENTER COVER**

- a) Reconnect the connectors.
- b) Reinstall the 2 clips and lower center cover.

**12. RECONNECT THE NEGATIVE BATTERY TERMINAL AND PERFORM ANY NEEDED INITIALIZATIONS**

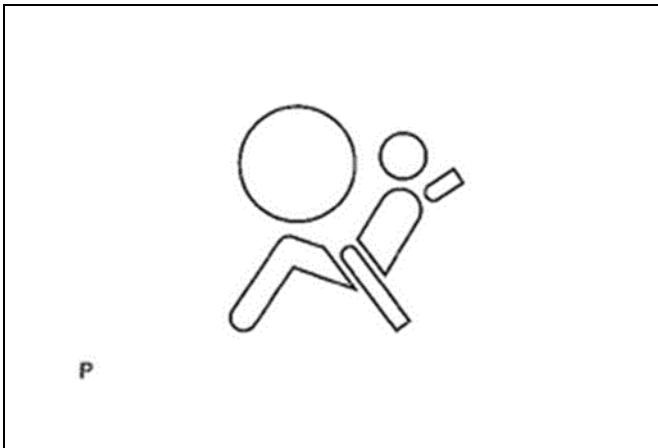

**13. INSPECT SRS WARNING LIGHT**

- a) Turn the ignition switch to the ON position, and check that the SRS warning light comes on for approximately 6 seconds (primary check).
- b) Check that the SRS warning light goes off approximately 6 seconds after the ignition switch is turned to the ON position (constant check).

**◀ VERIFY REPAIR QUALITY ▶**

- Ensure all precautions are followed to ensure safety during repair.  
 If you have any questions regarding this repair, please contact your area representative.

## VIII. APPENDIX

### A. CAMPAIGN DESIGNATION DECODER

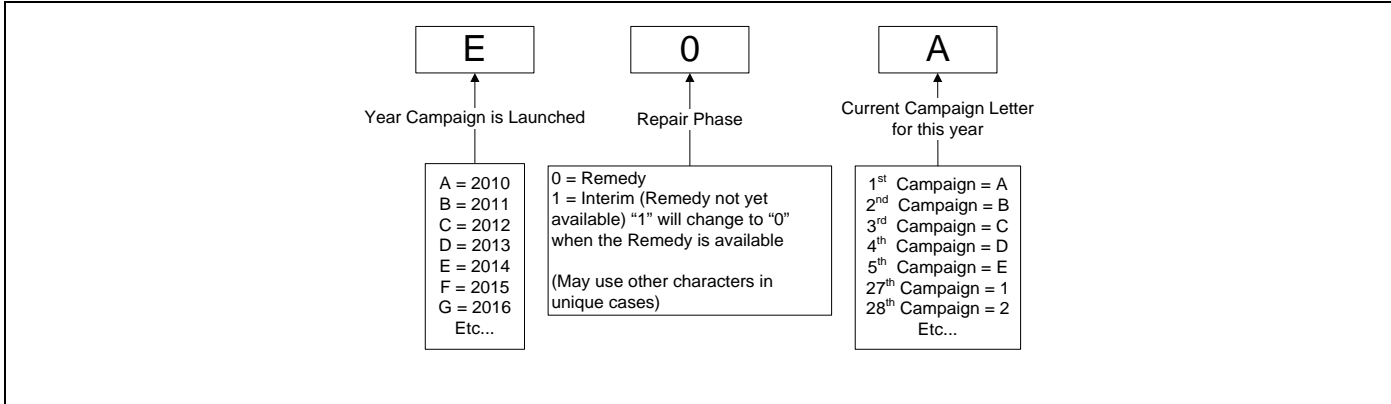

#### Examples:

A0D = Launched in 2010, Remedy Phase, 4<sup>th</sup> Campaign Launched in 2010

C1B = Launched in 2012, Interim Phase, 2<sup>nd</sup> Campaign Launched in 2012

E0A = Launched in 2014, Remedy Phase, 1<sup>st</sup> Campaign Launched in 2013

### B. CAMPAIGN PARTS DISPOSAL

As required by Federal Regulations, please make sure all campaign parts (original parts) removed from the vehicle are disposed of in a manner in which they will not be reused, ***unless requested for parts recovery return.***