

February 2017
FL721A-E
NHTSA #16V-656
Transport Canada #16-441
REVISED NOTICE

Subject: CNG Fuel Tank and CPDM Mounting Location

Models Affected: Specific Freightliner Cascadia vehicles manufactured September 24, 2012, through May 27, 2015, built with CNG fuel tanks

General Information

Daimler Trucks North America LLC (DTNA), on behalf of its Freightliner Trucks Division, has decided that a defect that relates to motor vehicle safety exists on the vehicles mentioned above.

There are approximately 1,040 vehicles involved in this campaign.

The chassis power distribution module (CPDM) is located at the back of the cab and beneath the compressed natural gas (CNG) fuel tank. Due to the location of the CPDM, it may be subject to higher than expected levels of water spray and contamination from the road, which may lead to localized melting or burning of the CPDM in close proximity to the CNG fuel tanks. This may increase the risk of a vehicle fire.

The CPDM will be removed and new wiring will be installed.

REVISION: The work instructions for all groups have been revised and further figures have been added. Some part numbers have been corrected.

Additional Repairs

Dealers must complete all outstanding Recall and Field Service campaigns prior to the sale or delivery of a vehicle. A Dealer will be liable for any progressive damage that results from its failure to complete campaigns before sale or delivery of a vehicle.

Owners may be liable for any progressive damage that results from failure to complete campaigns within a reasonable time after receiving notification.

Work Instructions

Please refer to the attached work instructions. Prior to performing the campaign, check the vehicle for a completion sticker (Form WAR260).

Replacement Parts

Replacement parts are now available and can be obtained by ordering the kit number(s) listed below from your facing Parts Distribution Center.

If our records show your dealership has ordered any vehicles involved in campaign number FL721, a list of the customers and vehicle identification numbers will be available in OWL. Please refer to this list when ordering parts for this recall.

Table 1 - Replacement Parts for FL721

Campaign Number	Kit Number	Part Description	Part Number	Qty. per Kit
FL721A (764 Vehicles)	25-FL721-000	HARNES-TRAILER,OL,DASH,PRI,RCPT	A06-93000-000	1 ea
		HARNES-TRAILER,PRI RCPT,90 DEG	A06-93163-072	1 ea
		HARNES-ABS,OL,DASH,TRAILER LP	A06-82360-000	1 ea
		HARNES-TRLR,CHAS F OL,PRI,BOC,84"	A06-93018-084	1 ea
		HARNES-TRAILER,DASH OL,PLC FLT,PRIM	A06-93209-000	1 ea
		HARNES-ABS,OL,DASH,IGN W/PLC	A06-93668-000	1 ea
		PLUG-9CAV	AI 7 968971 1	1 ea
		PLUG 14CAV	23-13153-011	1 ea
		SEAL-CAV PLUG	FCI 54200005	14 ea
		TAPE-ABRASION RESISTANT	48-25910-003	1 ea
		RELAY-12V MINI	23-11276-020	1 ea
		COMPLETION STICKER	WAR260	1 ea

February 2017
FL721A-E
NHTSA #16V-656
Transport Canada #16-441
REVISED NOTICE

Campaign Number	Kit Number	Part Description	Part Number	Qty. per Kit
FL721B (168 Vehicles)	25-FL721-001	HARNESS-TRAILER,OL,DASH,PRI,RCPT	A06-93000-000	1 ea
		HARNESS-TRAILER,PRI RCPT,90 DEG	A06-93163-072	1 ea
		HARNESS-TRLR SUPPL,OL,DASH	A06-93167-000	1 ea
		HARNESS-TRLR SUPPL,90 DEG	A06-93166-048	1 ea
		HARNESS-TRLR,CHAS F OL,PRI,BOC,84"	A06-93018-084	1 ea
		HARNESS-TRLR SUPPL,OL,CHAS F,113,58"	A06-93164-058	1 ea
		HARNESS-TRLR,DSH OL,PLC FLTR,DUAL	A06-93209-003	1 ea
		HARNESS-ABS,OL,DASH,IGN W/PLC	A06-93668-000	1 ea
		PLUG-9CAV	AI 7 968971 1	1 ea
		PLUG 14CAV	23-13153-011	1 ea
		SEAL-CAV PLUG	FCI 54200005	14 ea
		TAPE-ABRASION RESISTANT	48-25910-003	1 ea
		RELAY-12V MINI	23-11276-020	1 ea
		RELAY-ELECTROMAGNETIC	SOG 896H1CR1U0312S	1 ea
		COMPLETION STICKER	WAR260	1 ea
FL721C (84 Vehicles)	25-FL721-002	HARNESS-TRAILER, OL, DASH, PRI, RCPT	A06-93000-000	1 ea
		HARNESS-TRAILER,PRI RCPT,90 DEG	A06-93163-072	1 ea
		HARNESS-TRLR,PRI RCPT, STRAIGHT, 22"	A06-93162-022	1 ea
		HARNESS-TRLR,CHAS F OL,PRI,EOF,132"	A06-93229-132	1 ea
		HARNESS-ABS,OL,DASH,TRAILER LP	A06-82360-000	1 ea
		HARNESS-TRLR,CHAS F OL,PRIM, 113	A06-93227-000	1 ea
		HARNESS-TRLR,CHAS F OL, PRI,CHS,6"	A06-93228-006	1 ea
		HARNESS-TRAILER,DASH OL,PLC FLT,PRIM	A06-93209-000	1 ea
		HARNESS-ABS,OL,DASH,IGN W/PLC	A06-93668-000	1 ea
		PLUG-9CAV	AI 7 968971 1	1 ea
		PLUG 14CAV	23-13153-011	1 ea
		SEAL-CAV PLUG	FCI 54200005	14 ea
		TAPE-ABRASION RESISTANT	48-25910-003	1 ea
		RELAY-12V MINI	23-11276-020	1 ea
		COMPLETION STICKER	WAR260	1 ea
FL721D (16 Vehicles)	25-FL721-003	HARNESS-TRAILER,OL,DASH,PRI,RCPT	A06-93000-000	1 ea
		HARNESS-TRAILER,PRI RCPT,90 DEG	A06-93163-072	1 ea
		HARNESS-ABS,OL,DASH,IGN W/PLC	A06-93668-000	1 ea
		HARNESS-TRLR,CHAS F OL,PRI,BOC,84"	A06-93018-084	1 ea
		HARNESS-TRAILER,DASH OL,PLC FLT,PRIM	A06-93209-000	1 ea
		PLUG-9CAV	AI 7 968971 1	1 ea
		PLUG 14CAV	23-13153-011	1 ea
		SEAL-CAV PLUG	FCI 54200005	14 ea
		TAPE-ABRASION RESISTANT	48-25910-003	1 ea
		RELAY-12V MINI	23-11276-020	1 ea
		COMPLETION STICKER	WAR260	1 ea
FL721E (5 Vehicles)	Submit a WSC inquiry for FL721E parts list			

Table 1, Continued from the previous page

February 2017
FL721A-E
NHTSA #16V-656
Transport Canada #16-441
REVISED NOTICE

Removed Parts

U.S. and Canadian Dealers, please follow Warranty Failed Parts Tracking shipping instructions for the disposition of all removed parts. Export distributors, please destroy removed parts unless otherwise advised.

Labor Allowance

Table 2 - Labor Allowance

Campaign Number	Procedure	Time Allowed (hours)	SRT Code	Damage Code
FL721A	Remove CPDM/Rewire Primary Receptacle	2.4	996-0997A	12 - Repair Recall/Campaign
FL721B	Remove CPDM/Rewire Primary and Supplemental Receptacles	2.9	996-0997B	12 - Repair Recall/Campaign
FL721C	Remove CPDM/Rewire Primary and Supplemental Receptacles	3.2	996-0997C	12 - Repair Recall/Campaign
FL721D	Remove CPDM/Rewire Primary Receptacle	2.4	996-0997D	12 - Repair Recall/Campaign
FL721E	Remove CPDM/Rewire Primary Receptacle	2.4	996-0997E	12 - Repair Recall/Campaign

Table 2

IMPORTANT: When the Recall has been completed, locate the base completion label in the appropriate location on the vehicle, and attach the red completion sticker provided in the recall kit (Form WAR260). If the vehicle does not have a base completion label, clean a spot on the appropriate location of the vehicle and first attach the base completion label (Form WAR259). If a recall kit is not required or there is no completion sticker in the kit, write the recall number on a blank sticker and attach it to the base completion label.

Claims for Credit

You will be reimbursed for your parts, labor, and handling (landed cost for Export Distributors) by submitting your claim through the Warranty system within 30 days of completing this campaign. Please reference the following information in OWL:

- Claim type is **Recall**.
- In the FTL Authorization field, enter the campaign number and appropriate condition code (e.g. **FL721-A, FL721-B, etc.**).
- In the Primary Failed Part Number field, enter **25-FL721-000**.
- In the Parts field, enter the appropriate kit or part number(s) as shown in the Replacement Parts Table.
- In the Labor field, first enter the appropriate SRT from the Labor Allowance Table. Administrative time will be included automatically as SRT 939-0010A for 0.3 hours.
- The VMRS Component Code is **034-004-292** and the Cause Code is **A1 - Campaign**.
- **U.S. and Canada -- Reimbursement for Prior Repairs.** When a customer asks about reimbursement, please do the following:
 - Accept the documentation of the previous repair.
 - Make a brief check of the customer’s paperwork to see if the repair may be eligible for reimbursement. (See the "Copy of Owner Letter" section of this bulletin for reimbursement guidelines.)
 - Submit an OWL Recall Pre-Approval Request for a decision.

**February 2017
FL721A-E
NHTSA #16V-656
Transport Canada #16-441
REVISED NOTICE**

- Include the approved amount on your claim in the Other Charges section.
- Attach the documentation to the pre-approval request.
- If approved, submit a based on claim for the pre-approval.
- Reimburse the customer the appropriate amount.

IMPORTANT: OWL must be viewed prior to performing the recall to ensure the vehicle is involved and the campaign has not been previously completed. Also, check for a completion sticker prior to beginning work.

U.S. and Canadian dealers, contact the Warranty Campaigns Department from 7:00 a.m. to 4:00 p.m. Pacific Time, Monday through Friday, via Web inquiry at DTNACConnect.com / WSC, or the Customer Assistance Center at (800) 385-4357, after normal business hours, if you have any questions or need additional information. Export distributors, submit a Web inquiry or contact your International Service Manager.

U.S. and Canadian Dealers: To return excess kit inventory related to this campaign, U.S. dealers must submit a Parts Authorization Return (PAR) to the Memphis PDC. Canadian dealers must submit a PAR to their facing PDC. All kits must be in resalable condition. PAR requests must include the original purchase invoice number. Export Distributors: Excess inventory is not returnable.

The letter notifying U.S. and Canadian vehicle owners is included for your reference.

Please note that the National Traffic and Motor Vehicle Safety Act, as amended (Title 49, United States Code, Chapter 301), requires the owner's vehicle(s) be corrected within a reasonable time after parts are available to you. The Act states that failure to repair a vehicle within 60 days after tender for repair shall be prima facie evidence of an unreasonable time. However, circumstances of a particular situation may reduce the 60 day period. Failure to repair a vehicle within a reasonable time can result in either the obligation to (a) replace the vehicle with an identical or reasonably equivalent vehicle, without charge, or (b) refund the purchase price in full, less a reasonable allowance for depreciation. The Act further prohibits dealers from selling a vehicle unless all outstanding recalls are performed. Any lessor is required to send a copy of the recall notification to the lessee within 10 days. Any subsequent stage manufacturer is required to forward this notice to its distributors and retail outlets within five working days.

February 2017
FL721A-E
NHTSA #16V-656
Transport Canada #16-441
REVISED NOTICE

Copy of Notice to Owners
Subject: CNG Fuel Tank and CPDM Mounting Location

For the Notice to U.S. Customers: This notice is sent to you in accordance with the National Traffic and Motor Vehicle Safety Act. **For the Notice to Canadian Customers:** This notice is sent to you in accordance with the Canadian Motor Vehicle Safety Act.

Daimler Trucks North America LLC (DTNA), on behalf of its Freightliner Trucks Division, has decided that a defect that relates to motor vehicle safety exists on specific Freightliner Cascadia vehicles manufactured September 24, 2012, through May 27, 2015, built with CNG fuel tanks.

The chassis power distribution module (CPDM) is located at the back of the cab and beneath the compressed natural gas (CNG) fuel tank. Due to the location of the CPDM, it may be subject to higher than expected levels of water spray and contamination from the road, which may lead to localized melting or burning of the CPDM in close proximity to the CNG fuel tanks. This may increase the risk of a vehicle fire.

The CPDM will be removed and new wiring will be installed.

Please contact an authorized Daimler Trucks North America dealer to arrange to have the Recall performed and to ensure that parts are available at the dealership. To locate an authorized dealer, search online at www.Daimler-TrucksNorthAmerica.com / Contact Us / Find a Dealer. The Recall will take approximately three hours and will be performed at no charge to you.

You may be liable for any progressive damage that results from your failure to complete the Recall within a reasonable time after receiving notification.

If you do not own the vehicle that corresponds to the identification number(s) which appears on the Recall Notification, please return the notification to the Warranty Campaigns Department with any information you can furnish that will assist us in locating the present owner. If you have leased this vehicle, Federal law requires that you forward this notice to the lessee within 10 days. If you are a subsequent stage manufacturer, Federal law requires that you forward this notice to your distributors and retail outlets within five working days. If you have paid to have this recall condition corrected prior to this notice, you may be eligible to receive reimbursement. Please see the reverse side of this notice for details.

For the Notice to U.S. Customers: If you have questions about this Recall, please contact the Warranty Campaigns Department at (800) 547-0712, 7:00 a.m. to 4:00 p.m. Pacific Time, Monday through Friday, e-mail address DTNA.Warranty.Campaigns@Daimler.com, or the Customer Assistance Center at (800) 385-4357 after normal business hours. If you are not able to have the defect remedied without charge and within a reasonable time, you may wish to submit a complaint to the Administrator, National Highway Traffic Safety Administration, 1200 New Jersey Avenue, SE., Washington, DC 20590; or call the Vehicle Safety Hotline at (888) 327-4236 (TTY: 800-424-9153); or to <http://www.safercar.gov>. **For the Notice to Canadian Customers:** If you have questions about this Recall, please contact the Warranty Campaigns Department at (800) 547-0712, 7:00 a.m. to 4:00 p.m. Pacific Time, Monday through Friday, e-mail address DTNA.Warranty.Campaigns@Daimler.com, or the Customer Assistance Center at (800) 385-4357 after normal business hours.

We regret any inconvenience this action may cause but feel certain you understand our interest in motor vehicle safety.

WARRANTY CAMPAIGNS DEPARTMENT

Enclosure

February 2017
FL721A-E
NHTSA #16V-656
Transport Canada #16-441
REVISED NOTICE

Reimbursement to Customers for Repairs Performed Prior to Recall

If you have already **paid** to have this recall condition corrected you may be eligible to receive reimbursement.

Requests for reimbursement may include parts and labor. Reimbursement may be limited to the amount the repair would have cost if completed by an authorized Daimler Trucks North America LLC dealer. The following documentation must be presented to your dealer for consideration for reimbursement.

Please provide original or clear copies of all receipts, invoices, and repair orders that show:

- The name and address of the person who paid for the repair
- The Vehicle Identification Number (VIN) of the vehicle that was repaired
- What problem occurred, what repair was done, when the repair was done
- Who repaired the vehicle
- The total cost of the repair expense that is being claimed
- Proof of payment for the repair (such as the front and back of a cancelled check or a credit card receipt)

Reimbursement will be made by check from your Daimler Trucks North America LLC dealer.

Please speak with your Daimler Trucks North America LLC authorized dealer concerning this matter.

February 2017
FL721A-E
NHTSA #16V-656
Transport Canada #16-441
REVISED NOTICE

Work Instructions

Subject: CNG Fuel Tank and CPDM Mounting Location

Models Affected: Specific Freightliner Cascadia vehicles manufactured September 24, 2012, through May 27, 2015, built with CNG fuel tanks

REVISION: The work instructions for all groups have been revised and further figures have been added. Some part numbers have been corrected.

Safety Precautions



This recall procedure should be performed with the Natural Gas vehicle outside unless the facility is equipped with a proper CNG venting and detection system as well as safety fluorescent lights. Failure to observe these precautions could lead to the ignition of the natural gas, which could cause severe bodily injury, death, or property damage.

Workshop Precautions

Do not store a CNG vehicle indoors for any extended period of time. Observe the following safety precautions when CNG vehicles are inside a workshop:

- Use only safety fluorescent extension shop lights.
- Ensure the shop ceiling is equipped with a vent system that will allow gas to escape and dissipate.
- Ensure the shop is equipped with an alarm system that activates when gas concentration in the air becomes dangerous.
- Have CO2 fire extinguishers (ABC minimum) located in a highly visible and easily accessible location.
- Permit no smoking or other ignition sources within thirty feet of a CNG vehicle.
- Avoid open flames or sparks near a CNG vehicle.
- Close the fuel cylinder shutoff valves when storing the vehicle inside. Open the valves only if CNG is needed to operate the engine or to check for leaks.

General Procedure

IMPORTANT: This procedure will result in the complete removal of the 335 BOM chassis PDM, and conversion of the wiring to the primary and supplementary receptacles, making it similar to current-production Cascadia built with no chassis PDM (circuits supplied directly from the SAM chassis). The power to the receptacles and ABS module will come from the SAM chassis through a PLC filter instead of through the chassis PDM.

1. Check the base label (Form WAR259) for a completion sticker for FL721 (Form WAR260) indicating this work has been completed. The base label is usually located on the passenger-side door, about 12 inches (30 cm) below the door latch. If a completion sticker is present, no work is needed. If a completion sticker is not present, proceed to the next step.
2. Park the vehicle, shut down the engine, and apply the parking brakes. Chock tires.

February 2017
FL721A-E
NHTSA #16V-656
Transport Canada #16-441
REVISED NOTICE

NOTE: FL721-E affects five vehicles. Submit a WSC inquiry for FL721-E parts list. Parts for all other vehicles are listed in Table 1.

3. Go to the appropriate procedure for the vehicle being repaired:
 - FL721-A Go to Remove CPDM/Rewire Primary Receptacle - FL721-A, page 8
 - FL721-B Go to Remove CPDM/Rewire Primary and Supplemental Receptacles - FL721-B, page 23
 - FL721-C Go to Remove CPDM/Rewire Primary and Supplemental Receptacles - FL721-C, page 26
 - FL721-D Go to Remove CPDM/Rewire Primary Receptacle - FL721-D, page 29
 - FL721-E Go to Remove CPDM/Rewire Primary Receptacle - FL721-E, page 32
4. After completing the repair, clean a spot on the base label (Form WAR259). Write the recall number, FL721, on a blank completion sticker (Form WAR260), to indicate the work has been completed and attach it to the base label.

Remove CPDM/Rewire Primary Receptacle - FL721-A

Reference the following new G06 schematic drawings that complement the new harnesses being added to the vehicle:

- G06-92951-000
- G06-92951-003
- G06-93675-000
- G06-93187-000

1. Shut off the gas valve and disconnect the batteries.
2. Remove the driver-side kick panel, the center lower dash cover, and the instrumentation control unit (ICU).
3. Raise the hood and disconnect the bulkhead connector 1A. See [Fig. 1](#). Remove the nut that secures the dash side 1A bulkhead connector to the front wall.



Fig. 1, Bulkhead Connector

February 2017
FL721A-E
NHTSA #16V-656
Transport Canada #16-441
REVISED NOTICE

NOTE: Make sure the terminals are locked in place by tugging on them after insertion.

4. Insert the terminals shown in **Table 3** into their respective cavities in the dash side 1A bulkhead connector.
See **Fig. 2**.

Bulkhead Connector 1A, Dash Side for FL721-A			
Harness	Circuit	Color	Cavity
A06-93000-000	23A	Brown	6
A06-93000-000	46A	Brown	7
A06-93209-000	45A	Dark Blue	10
A06-93000-000	36B	Red/White Stripe	12
A06-93000-000	38R	Dark Green	17
A06-93000-000	38L	Yellow	19

Table 3, Bulkhead Connector 1A, Dash Side for FL721-A

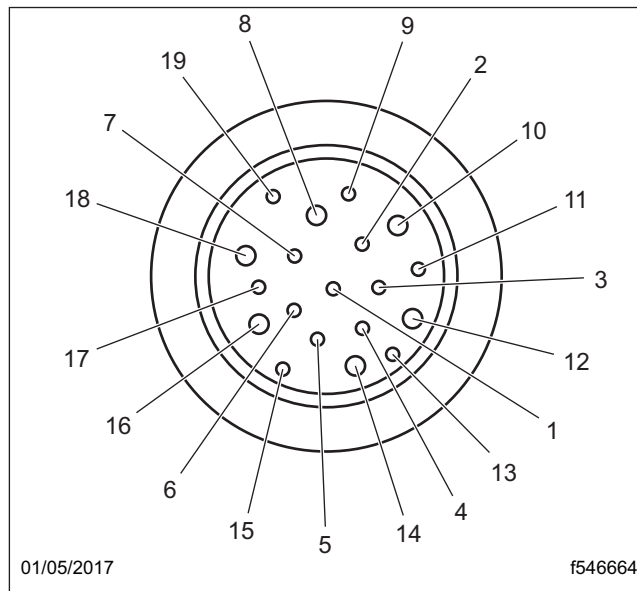

Fig. 2, 1A Bulkhead Connector Pinout (view from insertion or back side of plug)

February 2017
FL721A-E
NHTSA #16V-656
Transport Canada #16-441
REVISED NOTICE

5. Unsnap the terminal lock from the only populated connector (55B) on harness A06-93000-000. See [Fig. 3](#).

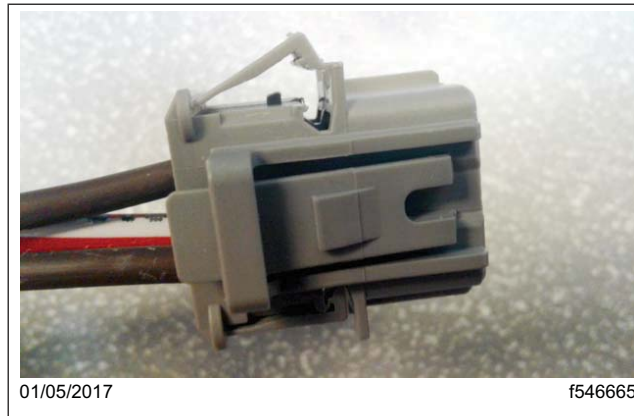

Fig. 3, 55B Terminal Lock (released or unsnapped)

6. Insert circuit 45 (dark blue) from harness A06-93209-000 into cavity 1 of connector 55B. See [Fig. 4](#) and [Fig. 5](#).

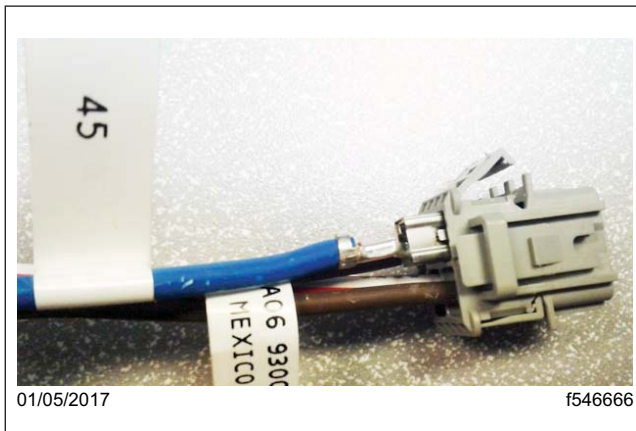

Fig. 4, Circuit 45 into Connector 55B

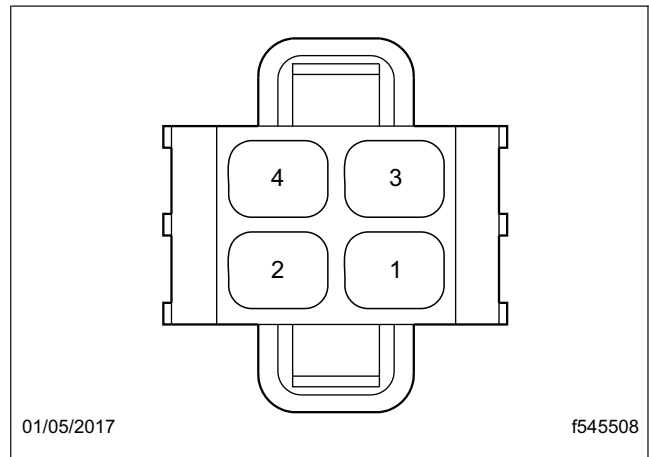

Fig. 5, 55B Pinout (view from insertion point)

7. Snap the terminal lock on connector 55B.

February 2017
FL721A-E
NHTSA #16V-656
Transport Canada #16-441
REVISED NOTICE

8. Insert circuits 38R (dark green) and 38L (yellow) from harness A06-93000-000 into cavities 7 and 9 respectively in connector 53B (the part is supplied loose in kit 23-13149-902). See [Fig. 6](#) and [Fig. 7](#).

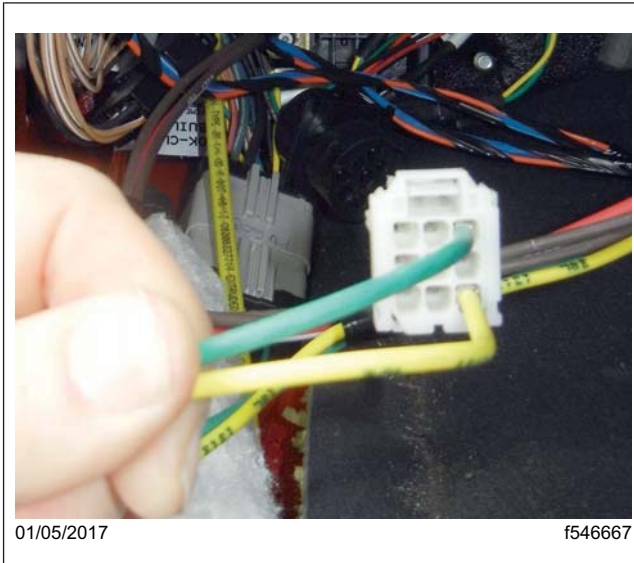

Fig. 6, Wires Inserted into Connector 53B

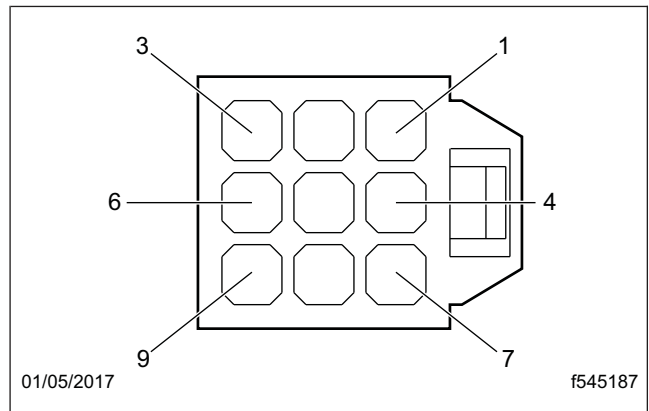

Fig. 7, 52B and 53B Pinout (view from insertion point)

9. Snap the terminal lock and plug in the connector into cavity X53 on the SAM Chassis. See [Fig. 8](#).

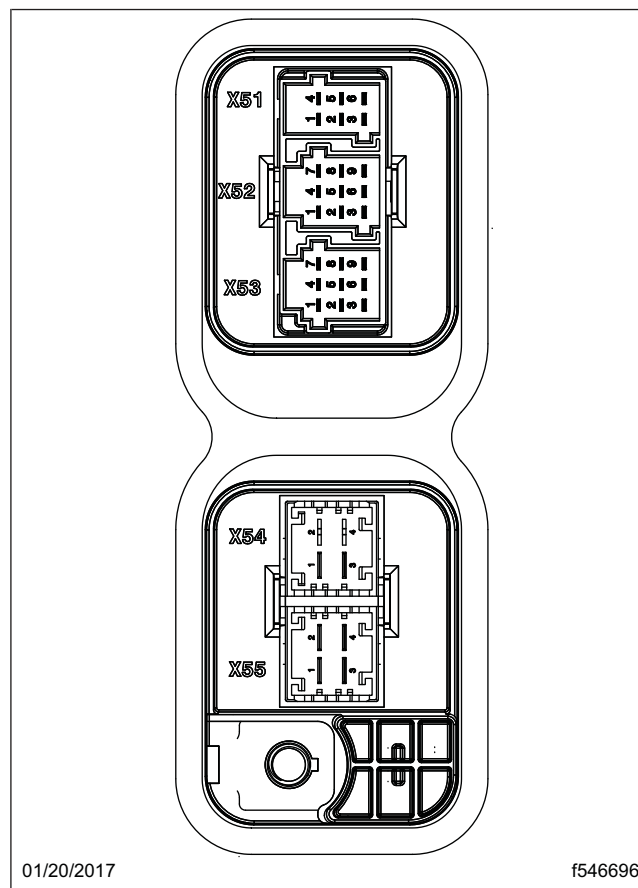

Fig. 8, SAM Chassis Connector Locations

February 2017
FL721A-E
NHTSA #16V-656
Transport Canada #16-441
REVISED NOTICE

- 10. Remove connector 52B from slot X52 on the SAM Chassis.
- 11. Unsnap the terminal lock. See Fig. 9.

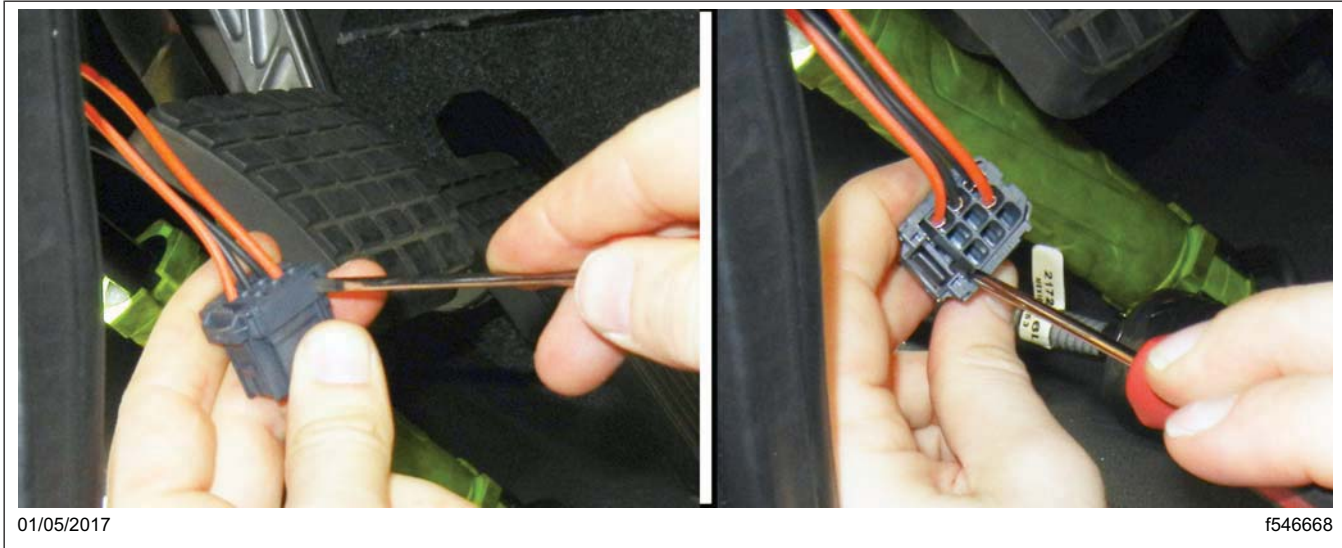

Fig. 9, Removing the Terminal Lock on Connector 52B

- 12. Remove the wire in cavity 6 of connector 52B. Fold the wire back against itself, and cover the terminal with heat shrink tubing. See Fig. 7.
- 13. Label the wire with tape with the description "Removed for FL721."
- 14. Insert circuit 376C (orange) from harness A06-93209-000 into cavity 6 on connector 52B. See Fig. 7.
- 15. Snap the terminal lock and plug the connector into slot X52 on the SAM Chassis.
- 16. Plug the 4-wire connector on harness A06-93000-000 into slot X55 on the SAM Chassis. See Fig. 10.

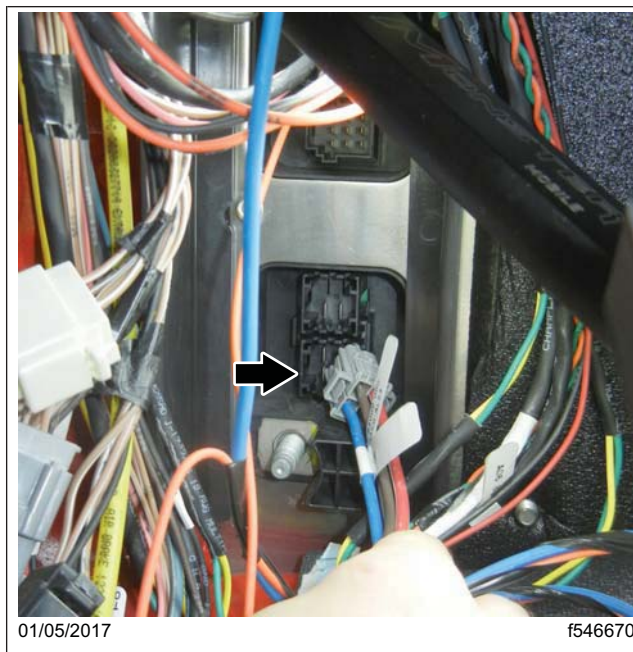

Fig. 10, Inserting the 4-Wire Connector into Slot X55 on the SAM Chassis

February 2017
FL721A-E
NHTSA #16V-656
Transport Canada #16-441
REVISED NOTICE

17. Remove the green cover and the grey terminal lock from the ABS ignition PLC filtered splice pack on harness A06-93209-000. See [Fig. 11](#).
18. Insert the GT150S terminal end of the single wire harness A06-93668-000 into any available cavity in the splice pack. See [Fig. 12](#). Install the terminal lock and cover.



Fig. 11, Splice Pack Cover and Lock (removed)



Fig. 12, Splice Pack Terminal Insertion

19. Route the splice pack behind the ICU near the radio. See [Fig. 13](#)



Fig. 13, Splice Pack Routing

February 2017
FL721A-E
NHTSA #16V-656
Transport Canada #16-441
REVISED NOTICE

20. Disconnect the 2A connector from the back of the ICU, then remove the terminal locks. See [Fig. 14](#).

21. Remove the existing wire from cavity D12 of ICU connector 2A. See [Fig. 15](#).



Fig. 14, ICU 2A connector Terminal Locks



Fig. 15, Wire Removal from Cavity D12 of ICU Connector 2A

22. Fold the wire back against itself, and cover the terminal with heat shrink tubing. See [Fig. 16](#).

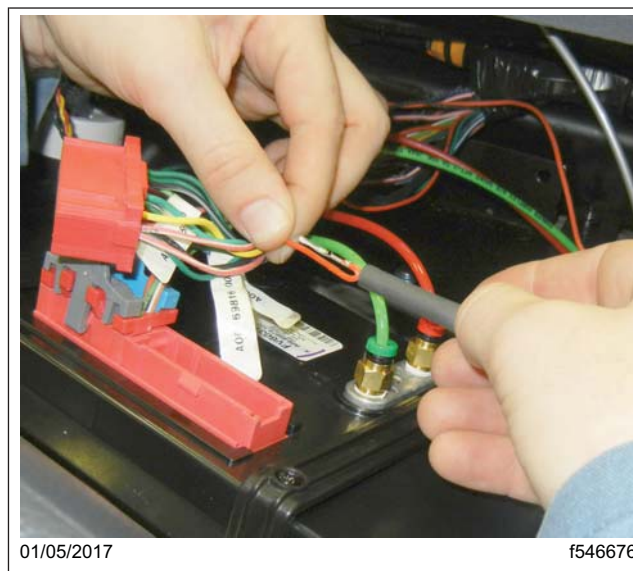

Fig. 16, 2A ICU Heat Shrink

February 2017
FL721A-E
NHTSA #16V-656
Transport Canada #16-441
REVISED NOTICE

23. Label the wire with tape with the description "Removed for FL721."
24. Insert the metri-pac 100 terminal end from single wire harness A06-82360-000 into ICU connector 2A, cavity D12. See [Fig. 17](#).
25. Install the terminal lock and plug connector 2A into the ICU.
26. Route wires A06-93668-000 and A06-82360-000 behind the dash and down to the ABS module. See [Fig. 18](#).

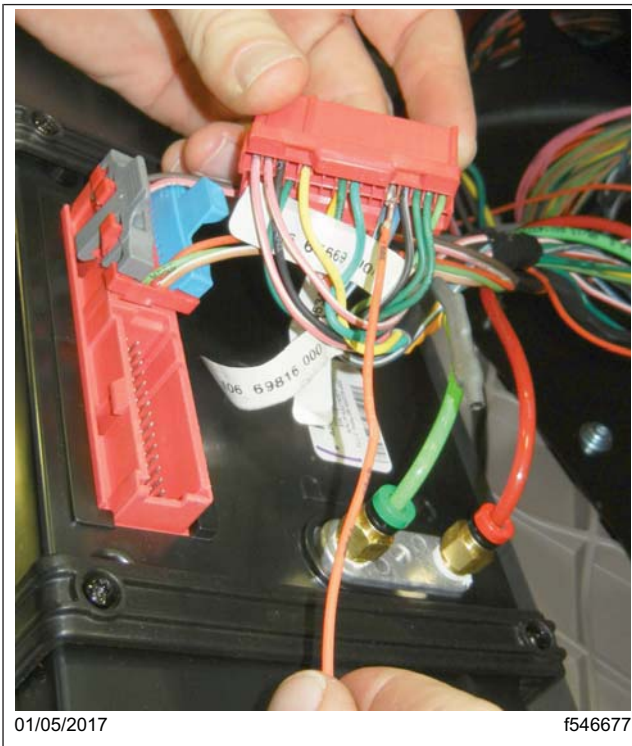

Fig. 17, Wire Insertion into Cavity D12 of ICU Connector 2A



Fig. 18, Routing the Wires to the ABS Module (FL721-A installation shown)

February 2017
FL721A-E
NHTSA #16V-656
Transport Canada #16-441
REVISED NOTICE

27. Disconnect connector X1A from the ABS module and remove the terminal lock. See [Fig. 19](#) and [Fig. 20](#)

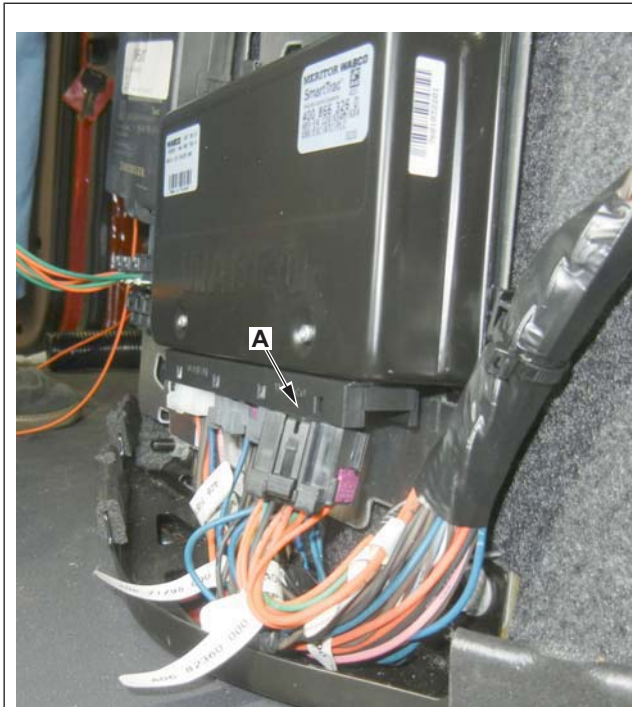

01/05/2017 f546679

A. Connector A is located on the right-hand side of the ABS module.

Fig. 19, Connector X1A on the ABS Module



01/05/2017 f546680

Fig. 20, Terminal Lock X1A

28. Remove the existing wires from cavities 2 and 7 of ABS module connector X1A. See [Fig. 21](#) and [Fig. 22](#).

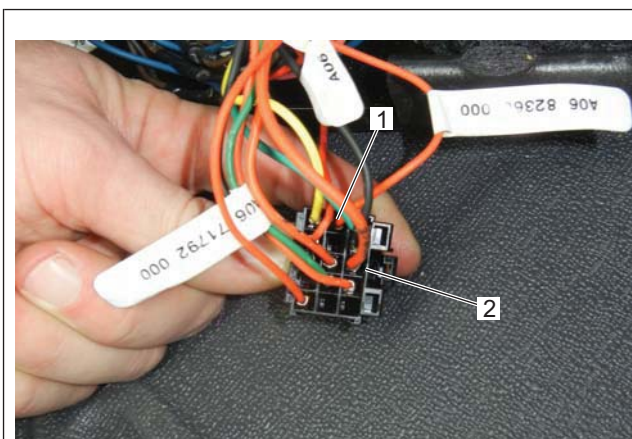

01/05/2017 f546681

- 1. Cavity 2
- 2. Cavity 7

Fig. 21, X1A Connector Terminals

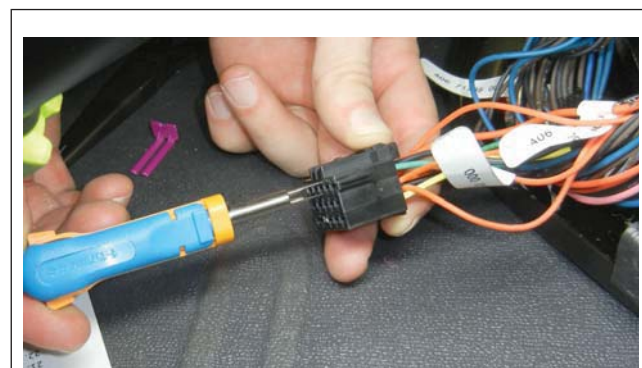

01/05/2017 f546682

Fig. 22, Terminal X1A Removal

February 2017
FL721A-E
NHTSA #16V-656
Transport Canada #16-441
REVISED NOTICE

29. Fold the removed wires back against themselves, and cover the exposed terminal ends with heat shrink tubing.
30. Label the wire with tape with the description "Removed for FL721."
31. Insert the free ends of single-wire harnesses A06-93668-000 and A06-82360-000 into ABS module connector X1A. Connect A06-93668-000 into cavity 7, and A06-82360-000 into cavity 2. See **Fig. 23**.
32. Install the terminal lock in connector X1A and plug the connector back into the ABS module.
33. Use cable ties to secure the bundle to the HVAC ducting behind the ICU. See **Fig. 24**.

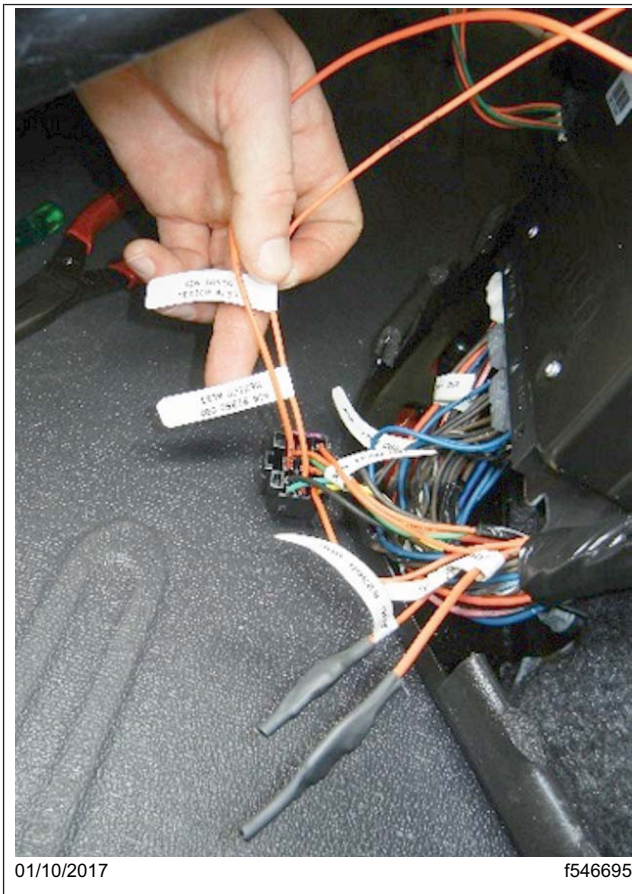

**Fig. 23, Both Wires Inserted into Connector X1A
(FL721-A installation shown)**



Fig. 24, PLC Bundle Mounting

February 2017
FL721A-E
NHTSA #16V-656
Transport Canada #16-441
REVISED NOTICE

34. Outside the cab, disconnect the CPDM harness and cap it with part number 23-13153-011. Plug each cavity with a cavity plug (23 13218 300). See **Fig. 25**, **Fig. 26**, and **Fig. 27**.

NOTE: Remove MEGA fuses from the PNDB if there are no other cables populated on the studs.

35. Disconnect the CPDM power cable from the PNDB and remove it from the vehicle. See **Fig. 28**. Replace any cable ties that were removed, which are still needed to secure other hoses and wiring.



Fig. 25, CPDM Harness Capped



Fig. 26, 23-13153-011 Populated with 23-13218-300 Plugs



Fig. 27, CPDM Harness Connector



Fig. 28, CPDM Power Cable on the PNDB

February 2017
FL721A-E
NHTSA #16V-656
Transport Canada #16-441
REVISED NOTICE

NOTE: The CPDM should be discarded after it is removed from the vehicle. It will not be used again.

36. Remove the CPDM from the vehicle. See [Fig. 29](#).



Fig. 29, CPDM Removed from the Vehicle

37. Wrap the exposed section of harness (A06-93018-084) with fiber wrap tape (48 25910 003). See [Fig. 30](#).

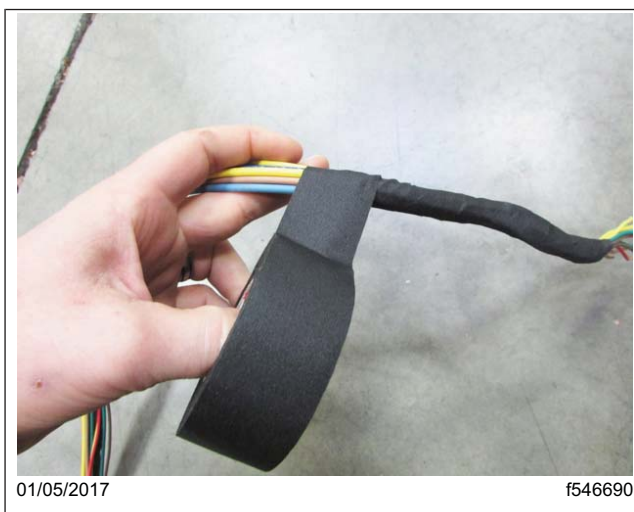

Fig. 30, Wrapping the Harness with Fiber Tape

February 2017
FL721A-E
NHTSA #16V-656
Transport Canada #16-441
REVISED NOTICE

NOTE: Route the harness safely away from sharp points and edges, moveable parts, and other possible sources of abrasion, cutting, pinching, or crushing. Secure it to the frame rail at regular intervals using zip ties fastened to standoffs. Whenever possible, the harness should be routed behind the air and hydraulic lines.

38. Route harness A06-93018-084 along the frame rail to bulkhead connector 1A. See [Fig. 31](#).

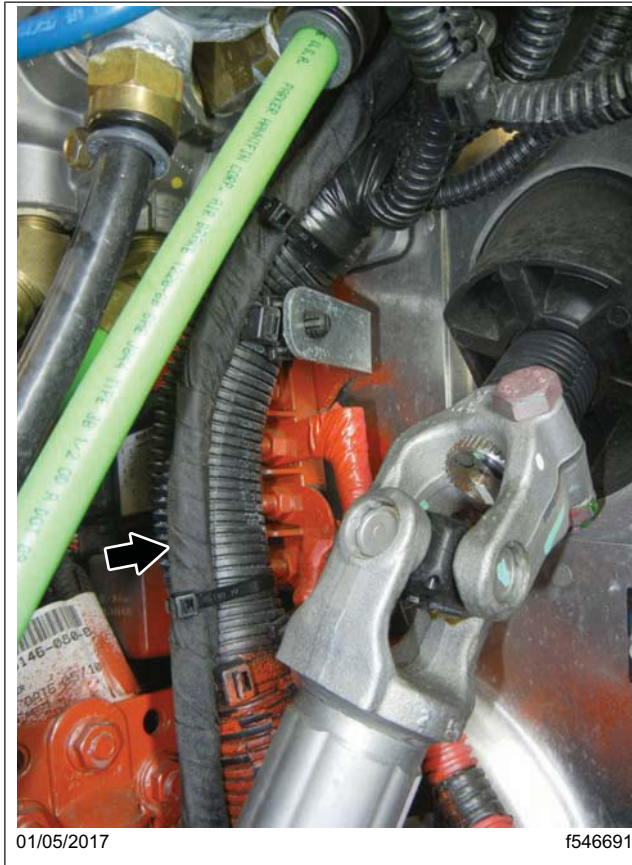

Fig. 31, Bulkhead Harness Routing

39. Insert the terminals into their respective cavities in the engine-side 1A bulkhead connector. See [Table 4](#).

Bulkhead Connector 1A, Engine Side for FL721-A			
Harness	Circuit	Color	Cavity
A06-93018-084	23A	Brown	6
A06-93018-084	46A	Brown	7
A06-93018-084	45	Dark Blue	10
A06-93018-084	36B	Red/White Stripe	12
A06-93018-084	38R	Dark Green	17
A06-93018-084	38L	Yellow	19

Table 4, Bulkhead Connector 1A, Engine Side for FL721-A

February 2017
FL721A-E
NHTSA #16V-656
Transport Canada #16-441
REVISED NOTICE

NOTE: The bulkhead connector is keyed with one flat side to be aligned with the D-shape in the frontwall hole.

40. Insert the cab side 1A bulkhead connector into the D-shaped hole and connect the engine side 1A bulkhead connector to it. See [Fig. 32](#).



Fig. 32, Bulkhead Connector 1A Cavity on the Frontwall

NOTE: The old harness that the primary receptacle harness was plugged into does not need to be capped and can stay where it sits in the frame rail.

41. Unplug the existing primary receptacle harness along the frame rail near the back of the Cab and remove the ground eyelet.
42. Remove the primary receptacle harness from the vehicle and discard it.
43. Install the new primary receptacle harness A06-93163-072 using the existing bracket.
44. Plug the two connectors on the end of harness A06-93018-084 into the mating connectors on the new primary receptacle harness A06-93163-072.
45. Secure the ground eyelet to the frame using the same stud used by the old primary receptacle ground wire, and coat it with dielectric red enamel spray or paint (48-25901-000, or equivalent).

February 2017
FL721A-E
NHTSA #16V-656
Transport Canada #16-441
REVISED NOTICE

46. Install relay 23-11276-020 (vendor p/n 896-1AH-C-R1-U03-12VDC) into cavity R8, and a 30-amp fuse into cavity F11 on the SAM Chassis. See **Fig. 33**.
47. Connect the battery cables.
48. Check parameters and verify that the following are set:
 - **Backup Lamps:** A0004471361-001 PARM-CHAS,BLK,BKS,MAN,AUT
 - **End-of-Frame Receptacle Power:** A0004478661-001 PARM-CHAS,EOF,SUP-R,NO CNT
 - **Trailer Configuration:** A0014470261-001 PARM-CHAS,TRA,BOC,IGN
49. Verify that the primary receptacle (**Fig. 34**) is functioning properly by performing the following checks with the ignition key in the ON position:
 - 49.1 Verify there is battery voltage on the Black terminal while the marker lamps are turned on.
 - 49.2 Verify there is battery voltage on the Brown terminal while the headlamps are turned on.
 - 49.3 Verify there is battery voltage on the Green terminal while the right turn signal is activated.
 - 49.4 Verify there is battery voltage on the Red terminal while the service brake is activated.
 - 49.5 Verify there is battery voltage on the Blue terminal at all times.
 - 49.6 Verify there is battery voltage on the Yellow terminal while the left turn signal is activated.
 - 49.7 If any circuits don't have power when they should, troubleshoot the circuit.

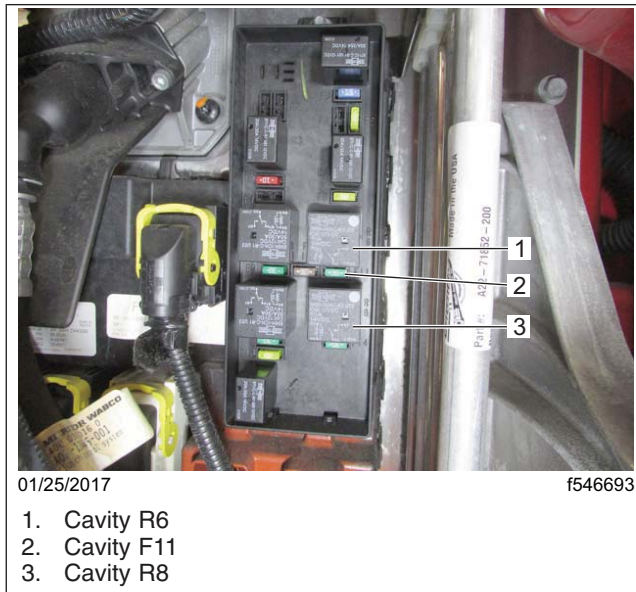

Fig. 33, Relays and Fuses on the SAM Chassis (FL721-B installation shown)

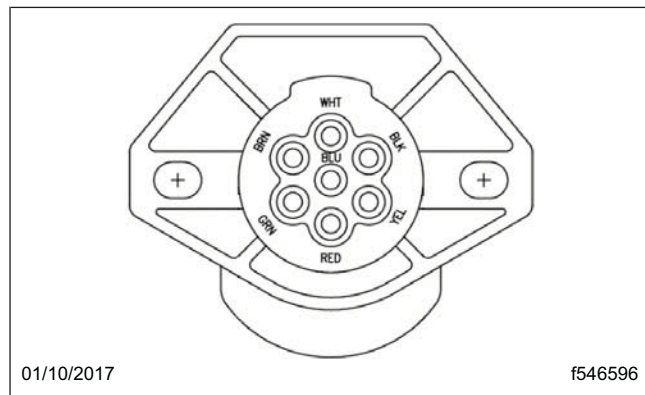

Fig. 34, Primary Receptacle Pinout

50. Install the kick panel, ICU, lower dash cover, and any dash panels that were removed.
51. Go to step 4 of the General Procedure on page 8.

February 2017
FL721A-E
NHTSA #16V-656
Transport Canada #16-441
REVISED NOTICE

Remove CPDM/Rewire Primary and Supplemental Receptacles - FL721-B

Reference the following new G06 schematic drawings that complement the new harnesses being added to the vehicle:

- G06-92951-000
- G06-92951-003
- G06-93132-000
- G06-93675-000
- G06-93187-003

1. Shut off the gas valve and disconnect the batteries.
2. Remove the driver-side kick panel, the center lower dash cover, and the instrumentation control unit (ICU).
3. Raise hood and disconnect bulkhead connector 1A. See [Fig. 1](#) . Remove the nut that secures the dash side 1A bulkhead connector to the front wall.

NOTE: Make sure the terminals are locked in place by tugging on them after insertion.

4. Insert the terminals shown in [Table 5](#) into their respective cavities in the dash side 1A bulkhead connector. See [Fig. 2](#).

Bulkhead Connector 1A, Dash Side for FL721-B			
Harness	Circuit	Color	Cavity
A06-93167-000	376F	Orange	1
A06-93000-000	23A	Brown	6
A06-93000-000	46A	Brown	7
A06-93209-003	45A	Dark Blue	10
A06-93000-000	36B	Red/White Stripe	12
A06-93000-000	38R	Dark Green	17
A06-93209-003	376D	Orange	18
A06-93000-000	38L	Yellow	19

Table 5, Bulkhead Connector 1A, Dash Side for FL721-B

5. Unsnap the terminal lock on the only populated connector on harness A06-93000-000. See [Fig. 3](#).
6. Insert circuit 45 (dark blue) from harness A06-93209-003 into cavity 1 of connector 55B. See [Fig. 4](#) and [Fig. 5](#).
7. Snap the terminal lock on connector 55B.
8. Insert circuits 38R (dark green) and 38L (yellow) of harness A06-93000-000 into cavities 7 and 9 respectively in connector 53B (supplied loose in kit 23-13149-902). See [Fig. 6](#) and [Fig. 7](#).
9. Snap the terminal lock and plug in the connector into cavity X53 on the SAM Chassis. See [Fig. 8](#).
10. Remove connector 52B from slot X52 in the SAM Chassis.
11. Unsnap the terminal lock. See [Fig. 9](#).
12. Remove the wire in cavity 6 of connector 52B. Fold the wire back against itself, and cover the terminal with heat shrink tubing. See [Fig. 7](#).
13. Label the wire with tape with the description "Removed for FL721."
14. Insert circuit 376C (orange) from harness A06-93209-003 into cavity 6 on connector 52B. See [Fig. 7](#).
15. Snap the terminal lock and plug the connector into slot X52 on the SAM Chassis.
16. Plug the 4-wire connector on harness A06-93209-003 into slot X54 on the SAM Chassis.

**February 2017
FL721A-E
NHTSA #16V-656
Transport Canada #16-441
REVISED NOTICE**

17. Plug the 4-wire connector on harness A06-93000-000 into slot x55 on the SAM Chassis. See [Fig. 10](#).
 18. Remove the green cover and grey terminal lock from the ABS ignition PLC filtered splice pack on harness A06-93209-003. See [Fig. 11](#).
 19. Insert the GT150S terminal end of the single wire harness A06-93668-000 into any available cavity in the splice pack. See [Fig. 12](#). Install the terminal lock and cover.
 20. Route the splice pack behind the ICU, near the radio. See [Fig. 13](#).
 21. Disconnect connector 2A from the back of the ICU, and remove the terminal locks. See [Fig. 14](#).
 22. Remove the existing wire from cavity D12 on ICU connector 2A. See [Fig. 15](#).
 23. Fold the removed wire back against itself, and cover the terminal with heat shrink tubing. See [Fig. 16](#).
 24. Label the wire with tape with the description "Removed for FL721."
 25. Insert the metri-pac 100 terminal end from single wire harness A06-93167-000 into ICU connector 2A, cavity D12. See [Fig. 17](#).
 26. Install the terminal lock, and plug connector 2A into the ICU.
 27. Route wires A06-93668-000 and A06-93167-000 behind the dash down to the ABS module. See [Fig. 18](#).
 28. Disconnect connector X1A from the ABS module and remove the terminal lock. See [Fig. 19](#) and [Fig. 20](#).
 29. Remove the existing wires from cavities 2 and 7 of ABS module connector X1A. See [Fig. 21](#) and [Fig. 22](#).
 30. Fold the removed wires back against themselves, and cover the exposed terminal ends with heat shrink tubing.
 31. Label the wire with tape with the description "Removed for FL721."
 32. Insert the free ends of single-wire harnesses A06-93668-000 and A06-93167-000 into ABS module connector X1A. Connect A06-93668-000 into cavity 7, and A06-93167-000 into cavity 2. See [Fig. 23](#).
 33. Install the terminal lock in connector X1A and plug connector back into the ABS module.
 34. Use cable ties to secure the bundle to the HVAC ducting behind the ICU. See [Fig. 24](#).
 35. Outside the cab, disconnect the chassis PDM (CPDM) harness and cap it with 23-13153-011. Plug each cavity with a cavity plug (23-13218-300). See [Fig. 25](#), [Fig. 26](#), and [Fig. 27](#).
- NOTE: Remove MEGA fuses from the PNDB if there are no other cables populated on the studs.
36. Disconnect the CPDM power cable from the PNDB and remove it from the vehicle. See [Fig. 28](#). Replace any cable ties that were removed, which are still needed to secure other hoses and wiring.
- NOTE: The CPDM should be discarded after it is removed from the vehicle. It will not be used again.
37. Remove the CPDM from the vehicle. See [Fig. 29](#).
 38. Wrap the sections of A06-93018-084 and A06-93164-058 that are not protected with convoluted tubing with fiber wrap tape (48-25910-003). See [Fig. 30](#).
- NOTE: Route the harness safely away from sharp points and edges, moveable parts, and other possible sources of abrasion, cutting, pinching, or crushing. Secure it to the frame rail at regular intervals using zip ties fastened to standoffs. Whenever possible, the harness should be routed behind the air and hydraulic lines.
39. Route harnesses A06-93018-084 and A06-93164-058 along the frame rail to bulkhead module connector 1A. See [Fig. 31](#).
 40. Insert the terminals into their respective cavities in the engine side 1A bulkhead connector. See [Table 6](#).
- NOTE: The bulkhead connector is keyed with one flat side to be aligned with the D-shape in the front wall hole.
41. Insert the cab-side 1A bulkhead connector into the D-shaped hole and connect the engine-side 1A bulkhead connector to it. See [Fig. 32](#).

February 2017
FL721A-E
NHTSA #16V-656
Transport Canada #16-441
REVISED NOTICE

Bulkhead Connector 1A, Engine Side for FL721-B			
Harness	Circuit	Color	Cavity
A06-93164-058	376F	Orange	1
A06-93018-084	23A	Brown	6
A06-93018-084	46A	Brown	7
A06-93018-084	45	Dark Blue	10
A06-93018-084	36B	Red/White Stripe	12
A06-93018-084	38R	Dark Green	17
A06-93164-058	376E	Orange	18
A06-93018-084	38L	Yellow	19

Table 6, Bulkhead Connector 1A Engine Side for FL721-B

42. Unplug the existing primary receptacle harness along the frame rail near the back of the cab and remove the ground eyelet.
43. Remove the primary receptacle harness from the vehicle and discard it.
44. Mount the new primary receptacle harness A06-93166-048 using the existing bracket.
45. Plug the two connectors on the end of harness A06-93164-058 into the mating connectors on the new primary receptacle harness A06-93166-048.
46. Plug the two connectors on the end of harness A06-93018-084 into the mating connectors on the new supplemental receptacle harness A06-93163-072.
47. Mount the new supplemental receptacle harness A06-93163-072 using the existing bracket.
48. Bolt the ground eyelets to the frame reusing the same bolts as the old receptacle ground wires and coat with dielectric red enamel spray or paint (48-25901-000, or equivalent).
49. Install relay 23-11276-020 (vendor p/n 896-1AH-C-R1-U03-12VDC) into cavity R8, 23-11276-011 (vendor p/n 896-ACH-C-R-U03-12VDC) into cavity R6, and a 30-amp fuse into cavity F11 of the SAM Chassis. See [Fig. 33](#).
50. Connect the battery cables.
51. Check parameters and verify that the following are set:
 - **Backup Lamps:** A0004471361-001 PARM-CHAS,BLK,BKS,MAN,AUT
 - **End-of-Frame Receptacle Power:** A0004478661-001 PARM-CHAS,EOF,SUP-R,NO CNT
 - **Trailer Configuration:** A0014470261-001 PARM-CHAS,TRA,BOC,IGN
52. Verify that the primary receptacle ([Fig. 34](#)) is functioning properly by performing the following checks with the ignition key in the ON position:
 - 52.1 Verify there is battery voltage on the Black terminal while the marker lamps are turned on.
 - 52.2 Verify there is battery voltage on the Brown terminal while the headlamps are turned on.
 - 52.3 Verify there is battery voltage on the Green terminal while the right turn signal is activated.
 - 52.4 Verify there is battery voltage on the Red terminal while the service brake is activated.
 - 52.5 Verify there is battery voltage on the Blue terminal at all times.
 - 52.6 Verify there is battery voltage on the Yellow terminal while the left turn signal is activated.
 - 52.7 If any circuits don't have power when they should, troubleshoot the circuit.
53. Install the kick panel, ICU, lower dash cover, and any dash panels that were removed.
54. Go to step 4 of the General Procedure on page 8.

February 2017
FL721A-E
NHTSA #16V-656
Transport Canada #16-441
REVISED NOTICE

Remove CPDM/Rewire Primary and Supplemental Receptacles -FL721-C

Reference the following new G06 schematic drawings that complement the new harnesses being added to the vehicle:

- G06-92951-000
- G06-92951-003
- G06-93675-000
- G06-93187-000

1. Shut off the gas valve and disconnect the batteries.
2. Remove the driver-side kick panel, the center lower dash cover, and the instrumentation control unit (ICU).
3. Raise hood and disconnect bulkhead connector 1A. See [Fig. 1](#). Remove the nut that secures the dash side 1A bulkhead connector to the front wall.

NOTE: Make sure the terminals are locked in place by tugging on them after insertion.

4. Insert the terminals shown in [Table 7](#) into their respective cavities in the dash side 1A bulkhead connector. See [Fig. 2](#).

Bulkhead Connector 1A, Dash Side for FL721-C			
Harness	Circuit	Color	Cavity
A06-93000-000	23A	Brown	6
A06-93000-000	46A	Brown	7
A06-93209-000	45A	Dark Blue	10
A06-93000-000	36B	Red/White Stripe	12
A06-93000-000	38R	Dark Green	17
A06-93000-000	38L	Yellow	19

Table 7, Bulkhead Connector 1A, Dash Side for FL721-C

5. Unsnap the terminal lock from the only populated connector on harness A06-93000-000. See [Fig. 3](#).
6. Insert circuit 45 (dark blue) from harness A06-93209-000 into cavity 1 of connector 55B. See [Fig. 4](#) and [Fig. 5](#).
7. Snap the terminal lock on connector 55B.
8. Insert circuits 38R (dark green) and 38L (yellow) from harness A06-93000-000 into cavities 7 and 9 respectively in connector 53B (supplied loose in kit 23-13149-902). See [Fig. 6](#) and [Fig. 7](#).
9. Snap the terminal lock and plug in the connector into cavity X53 on the SAM Chassis. See [Fig. 8](#).
10. Remove connector 52B from slot X52 on the SAM Chassis.
11. Unsnap the terminal lock. See [Fig. 9](#).
12. Remove the wire in cavity 6 of connector 52B. Fold the wire back against itself, and cover the terminal with heat shrink tubing. See [Fig. 7](#).
13. Label the wire with tape with the description "Removed for FL721."
14. Insert circuit 376C (orange) from harness A06-93209-000 into cavity 6 on connector 52B. See [Fig. 7](#).
15. Snap the terminal lock and plug in the connector into cavity X52 on the SAM Chassis.
16. Plug the 4-wire connector on harness A06-93000-000 into slot X55 on the SAM Chassis. See [Fig. 10](#).
17. Remove the green cover and the grey terminal lock from the ABS ignition PLC filtered splice pack on harness A06-93209-000. See [Fig. 11](#).

**February 2017
FL721A-E
NHTSA #16V-656
Transport Canada #16-441
REVISED NOTICE**

18. Insert the GT150S terminal end of the single wire harness A06-93668-000 into any available cavity in the splice pack. See [Fig. 12](#). Install the terminal lock and cover.
 19. Route the splice pack behind the ICU near the radio. See [Fig. 13](#).
 20. Disconnect the 2A connector from the back of the ICU, then remove the terminal locks. See [Fig. 14](#).
 21. Remove the existing wire from cavity D12 of ICU connector 2A. See [Fig. 15](#).
 22. Fold the wire back against itself, and cover the terminal with heat shrink tubing. See [Fig. 16](#)
 23. Label the wires with tape with the description "Removed for FL721."
 24. Insert the metri-pac 100 terminal end from single wire harness A06-82360-000 into ICU connector 2A, cavity D12. See [Fig. 17](#).
 25. Install the terminal lock and plug connector 2A into the ICU.
 26. Route wires A06-93668-000 and A06-82360-000 behind the dash and down to the ABS module. See [Fig. 18](#).
 27. Disconnect connector X1A from the ABS module and remove the terminal lock. See [Fig. 19](#) and [Fig. 20](#).
 28. Remove the existing wires from cavities 2 and 7 of ABS module connector X1A. See [Fig. 21](#) and [Fig. 22](#).
 29. Fold the removed wires back against themselves, and cover the exposed terminal ends with heat shrink tubing.
 30. Label the wire with tape with the description "Removed for FL721."
 31. Insert the free ends of single-wire harnesses A06-93668-000 and A06-82360-000 into ABS module connector X1A. Connect A06-93668-000 into cavity 7, and A06-82360-000 into cavity 2. See [Fig. 23](#).
 32. Install the terminal lock in connector X1A and plug the connector back into the ABS module.
 33. Use cable ties to secure the bundle to the HVAC ducting behind the ICU. See [Fig. 24](#).
 34. Outside the cab, disconnect the chassis PDM (CPDM) harness and cap it with 23-13153-011. Plug each cavity with a cavity plug (23-13218-300). See [Fig. 25](#), [Fig. 26](#), and [Fig. 27](#).
- NOTE: Remove MEGA fuses from the PNDB if there are no other cables populated on the studs.
35. Disconnect the CPDM power cable from the PNDB and remove it from the vehicle. See [Fig. 28](#). Replace any cable ties that were removed, which are still needed to secure other hoses and wiring.
- NOTE: The CPDM should be discarded after it is removed from the vehicle. It will not be used again.
36. Remove the CPDM from the vehicle. See [Fig. 29](#).
 37. Using Phillips STA Dry Crimp Solder Seal connectors (48-02461-038) splice blunt cut individual circuit wires from harness A06-93227-000 with their corresponding circuit wire numbers on harness A06-93228-006 and A06-93229-132. Stagger the splices at varied lengths to keep bundle from becoming unmanageable.
 38. Wrap the sections of A06-93228-006, A06-93229-132, and A06-93227-000 that are not protected with convoluted tubing with fiber wrap tape (48-25910-003). See [Fig. 30](#).
- NOTE: Route the harness safely away from sharp points and edges, moveable parts, and other possible sources of abrasion, cutting, pinching, or crushing. Secure it to the frame rail at regular intervals using zip ties fastened to standoffs. Whenever possible, the harness should be routed behind the air and hydraulic lines.
39. Route harness A06-93227-000 along the frame rail to bulkhead connector 1A. See [Fig. 31](#).
 40. Insert the terminals into their respective cavities in the engine-side 1A bulkhead connector. See [Table 8](#).
- NOTE: the bulkhead connector is keyed with one flat side to be aligned with the D-shape in the front wall hole.
41. Insert the cab-side 1A bulkhead connector into the D-shaped hole and connect the engine-side 1A bulkhead connector to it. See [Fig. 32](#).

February 2017
FL721A-E
NHTSA #16V-656
Transport Canada #16-441
REVISED NOTICE

Bulkhead Connector 1A, Engine Side for FL721-C			
Harness	Circuit	Color	Cavity
A06-93227-000	23A	Brown	6
A06-93227-000	46A	Brown	7
A06-93227-000	45	Dark Blue	10
A06-93227-000	36B	Red/White Stripe	12
A06-93227-000	38R	Dark Green	17
A06-93227-000	38L	Yellow	19

Table 8, Bulkhead Connector 1A, Engine Side for FL721-C

NOTE: The old harness that the primary receptacle harness was plugged into does not need to be capped and can stay where it sits in the frame rail.

42. Unplug the existing primary receptacle harness along the frame rail near the back of the cab and remove the ground eyelet.
43. Remove the primary receptacle harness from the vehicle and discard it.
44. Install the new primary receptacle harness A06-93163-072 using the existing bracket.
45. Plug the two connectors on the end of harness A06-93228-006 into the mating connectors on the new primary receptacle harness A06-93163-072.
46. Mount the new supplemental receptacle harness A06-93162-022 using the existing bracket.
47. Plug the two connectors on the end of harness A06-93229-132 into the mating connectors on the new supplemental receptacle harness A06-93162-022.
48. Bolt the ground eyelets to the frame reusing the same bolts as the old receptacle ground wires and coat with dielectric red enamel spray or paint (48-25901-000, or equivalent).
49. Install relay 23-11276-020 (vendor p/n 896-1AH-C-R1-U03-12VDC) into cavity R8, and a 30-amp fuse into cavity F11 on the SAM Chassis. See [Fig. 33](#).
50. Connect the battery cables.
51. Check parameters and verify that the following are set:
 - **Backup Lamps:** A0004471361-001 PARM-CHAS,BLK,BKS,MAN,AUT
 - **End-of-Frame Receptacle Power:** A0004478661-001 PARM-CHAS,EOF,SUP-R,NO CNT
 - **Trailer Configuration:** A0014470261-001 PARM-CHAS,TRA,BOC,IGN
52. Verify that the primary receptacle ([Fig. 34](#)) is functioning properly by performing the following checks with the ignition key in the ON position:
 - 52.1 Verify there is battery voltage on the Black terminal while the marker lamps are turned on.
 - 52.2 Verify there is battery voltage on the Brown terminal while the headlamps are turned on.
 - 52.3 Verify there is battery voltage on the Green terminal while the right turn signal is activated.
 - 52.4 Verify there is battery voltage on the Red terminal while the service brake is activated.
 - 52.5 Verify there is battery voltage on the Blue terminal at all times.
 - 52.6 Verify there is battery voltage on the Yellow terminal while the left turn signal is activated.
 - 52.7 If any circuits don't have power when they should, troubleshoot the circuit.
53. Install the kick panel, ICU, lower dash cover, and any dash panels that were removed.
54. Go to step 4 of the General Procedure on page 8.

February 2017
FL721A-E
NHTSA #16V-656
Transport Canada #16-441
REVISED NOTICE

Remove CPDM/Rewire Primary Receptacle - FL721-D

Reference the following new G06 schematic drawings that complement the new harnesses being added to the vehicle:

- G06-92951-000
- G06-92951-003
- G06-93675-000
- G06-93187-000

1. Shut off the gas valve and disconnect the batteries.
2. Remove the driver-side kick panel, the center lower dash cover, and the instrumentation control unit (ICU).
3. Raise hood and disconnect bulkhead connector 1A. See [Fig. 1](#). Remove the nut that secures the dash side 1A bulkhead connector to the front wall.

NOTE: Make sure the terminals are locked in place by tugging on them after insertion.

4. Insert the terminals shown in [Table 9](#) into their respective cavities in the dash side 1A bulkhead connector. See [Fig. 2](#).

Bulkhead Connector 1A, Dash Side for FL721-D			
Harness	Circuit	Color	Cavity
A06-93000-000	23A	Brown	6
A06-93000-000	46A	Brown	7
A06-93209-000	45A	Dark Blue	10
A06-93000-000	36B	Red/White Stripe	12
A06-93000-000	38R	Dark Green	17
A06-93000-000	38L	Yellow	19

Table 9, Bulkhead Connector 1A, Dash Side for FL721-D

5. Unsnap the terminal lock from the only populated connector on harness A06-93000-000. See [Fig. 3](#).
6. Insert circuit 45 (dark blue) from harness A06-93209-000 into cavity 1 of connector 55B. See [Fig. 4](#) and [Fig. 5](#).
7. Snap the terminal lock on connector 55B.
8. Insert circuits 38R (dark green) and 38L (yellow) from harness A06-93000-000 into cavities 7 and 9 respectively in connector 53B (supplied loose in kit 23-13149-902). See [Fig. 6](#) and [Fig. 7](#).
9. Snap the terminal lock and plug in the connector into cavity X53 on the SAM Chassis. See [Fig. 8](#).
10. Remove connector 52B from slot X52 on the SAM Chassis.
11. Unsnap the terminal lock. See [Fig. 9](#).
12. Remove the wire in cavity 6 of connector 52B. Fold the wire back against itself, and cover the terminal with heat shrink tubing. See [Fig. 7](#).
13. Label the wire with tape with the description "Removed for FL721."
14. Insert circuit 376C (orange) from harness A06-93209-000 into cavity 6 on connector 52B. See [Fig. 7](#).
15. Snap the terminal lock and plug in the connector into cavity X52 on the SAM Chassis.
16. Plug the 4-wire connector on harness A06-93000-000 into slot X55 on the SAM Chassis. See [Fig. 10](#).
17. Remove the green cover and the grey terminal lock from the ABS ignition PLC filtered splice pack on harness A06-93209-000. See [Fig. 11](#).

February 2017
FL721A-E
NHTSA #16V-656
Transport Canada #16-441
REVISED NOTICE

18. Insert the GT150S terminal end of the single wire harness A06-93668-000 into any available cavity in the splice pack. See [Fig. 12](#). Install the terminal lock and cover.
19. Route the splice pack behind the ICU near the radio. See [Fig. 13](#).
20. Route the wires from the splice pack behind the dash and down to the ABS module. See [Fig. 18](#)
21. Disconnect connector X1A from the ABS module and remove the terminal lock. See [Fig. 19](#) and [Fig. 20](#).
22. Remove the existing wires from cavity 7 of ABS module connector X1A. See [Fig. 21](#) and [Fig. 22](#).
23. Fold the removed wire back against itself, and cover the exposed terminal end with heat shrink tubing.
24. Label the wire with tape with the description "Removed for FL721."
25. Insert the free ends of single-wire harness A06-93668-000 into ABS module connector X1A, cavity 7. Connect A06-93668-000 into cavity 7. See [Fig. 35](#)

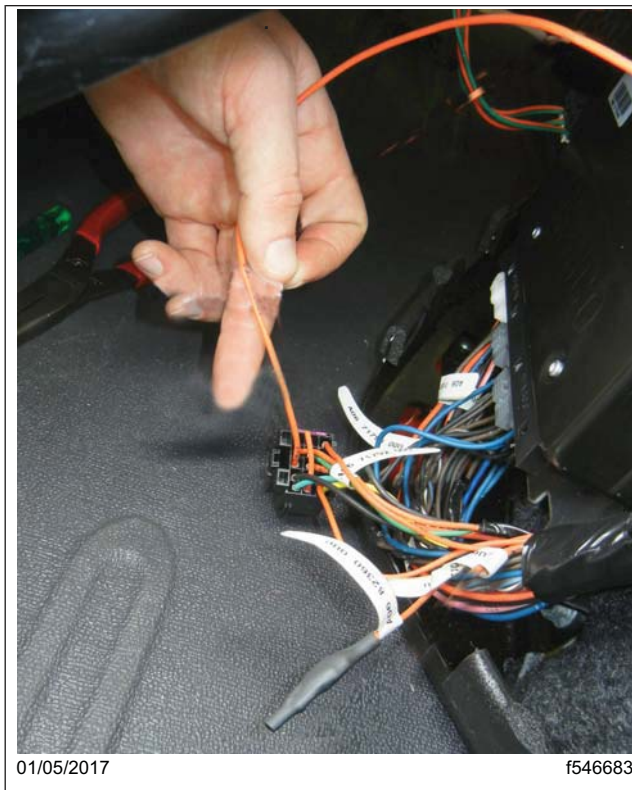

Fig. 35, Wire Inserted into Connector X1A

26. Install the terminal lock in connector X1A and plug the connector back into the ABS module.
27. Use cable ties to secure the bundle to the HVAC ducting behind the ICU. See [Fig. 24](#).
28. Outside the cab, disconnect the chassis PDM (CPDM) harness and cap it with 23-13153-011. Plug each cavity with a cavity plug (23-13218-300). See [Fig. 25](#), [Fig. 26](#), and [Fig. 27](#).

NOTE: Remove MEGA fuses from the PNDB if there are no other cables populated on the studs.

29. Disconnect the CPDM power cable from the PNDB and remove it from the vehicle. See [Fig. 28](#). Replace any cable ties that were removed, which are still needed to secure other hoses and wiring.

NOTE: The CPDM should be discarded after it is removed from the vehicle. It will not be used again.

30. Remove the CPDM from the vehicle. See [Fig. 29](#).

**February 2017
FL721A-E
NHTSA #16V-656
Transport Canada #16-441
REVISED NOTICE**

31. Wrap the section of harness A06-93018-084 that is not protected with convoluted tubing with fiber wrap tape (48-25910-003). See [Fig. 30](#).

NOTE: Route the harness safely away from sharp points and edges, moveable parts, and other possible sources of abrasion, cutting, pinching, or crushing. Secure it to the frame rail at regular intervals using zip ties fastened to standoffs. Whenever possible, the harness should be routed behind the air and hydraulic lines.

32. Route harness A06-93018-084 along the frame rail to bulkhead connector 1A. See [Fig. 31](#).

33. Insert the terminals into their respective cavities in the engine-side 1A bulkhead connector. See [Table 10](#).

Bulkhead Connector 1A, Engine Side for FL721-D			
Harness	Circuit	Color	Cavity
A06-93018-084	23A	Brown	6
A06-93018-084	46A	Brown	7
A06-93018-084	45	Dark Blue	10
A06-93018-084	36B	Red/White Stripe	12
A06-93018-084	38R	Dark Green	17
A06-93018-084	38L	Yellow	19

Table 10, Bulkhead Connector 1A, Engine Side for FL721-D

NOTE: the bulkhead connector is keyed with one flat side to be aligned with the D-shape in the front wall hole.

34. Insert the cab-side 1A bulkhead connector into the D-shaped hole and connect the engine-side 1A bulkhead connector to it. See [Fig. 32](#).

NOTE: The old harness that the primary receptacle harness was plugged into does not need to be capped and can stay where it sits in the frame rail.

35. Unplug the existing primary receptacle harness along the frame rail near the back of the cab and remove the ground eyelet.

36. Remove the primary receptacle harness from the vehicle and discard it.

37. Install the new primary receptacle harness A06-93163-072 using the existing bracket.

38. Plug the two connectors on the end of harness A06-93018-084 into the mating connectors on the new primary receptacle harness A06-93163-072.

39. Secure the ground eyelet to the frame using the same stud used by the old primary receptacle ground wire, and coat it with dielectric red enamel spray or paint (48-25901-000, or equivalent).

40. Install relay 23-11276-020 (vendor p/n 896-1AH-C-R1-U03-12VDC) into cavity R8, and a 30-amp fuse into cavity F11 on the SAM Chassis. See [Fig. 33](#).

41. Connect the battery cables.

42. Check parameters and verify that the following are set:

- **Backup Lamps:** A0004471361-001 PARM-CHAS,BLK,BKS,MAN,AUT
- **End-of-Frame Receptacle Power:** A0004478661-001 PARM-CHAS,EOF,SUP-R,NO CNT
- **Trailer Configuration:** A0014470261-001 PARM-CHAS,TRA,BOC,IGN

43. Verify that the primary receptacle ([Fig. 34](#)) is functioning properly by performing the following checks with the ignition key in the ON position:

- 43.1 Verify there is battery voltage on the Black terminal while the marker lamps are turned on.
- 43.2 Verify there is battery voltage on the Brown terminal while the headlamps are turned on.
- 43.3 Verify there is battery voltage on the Green terminal while the right turn signal is activated.
- 43.4 Verify there is battery voltage on the Red terminal while the service brake is activated.

February 2017
FL721A-E
NHTSA #16V-656
Transport Canada #16-441
REVISED NOTICE

- 43.5 Verify there is battery voltage on the Blue terminal at all times.
- 43.6 Verify there is battery voltage on the Yellow terminal while the left turn signal is activated.
- 43.7 If any circuits don't have power when they should, troubleshoot the circuit.
- 44. Install the kick panel, ICU, lower dash cover, and any dash panels that were removed.
- 45. Go to step 4 of the General Procedure on page 8.

Remove CPDM/Rewire Primary Receptacle - FL721-E

NOTE: FL721-E affects five vehicles. Submit a WSC inquiry for FL721-E parts list.

1. Shut off the gas valve and disconnect the batteries.
2. Remove the driver's-side kick panel, the center lower dash cover, the glove box, the instrumentation control unit (ICU), and the lower the B-panel.
3. Raise hood and disconnect bulkhead connector 1A. See **Fig. 1** . Remove the nut that secures the dash side 1A bulkhead connector to the front wall.

NOTE: Make sure the terminals are locked in place by tugging on them after insertion.

4. Insert the terminals shown in **Table 11** into their respective cavities in the dash side 1A bulkhead connector. See **Fig. 2**.

Bulkhead Connector 1A, Dash Side for FL721-E			
Harness	Circuit	Color	Cavity
A06-93208-000	23A	Brown	6
A06-93208-000	46A	Brown	7
A06-93208-000	45A	Dark Blue	10
A06-93208-000	36B	Red/White Stripe	12
A06-93208-000	38R	Dark Green	17
A06-93208-000	376D	Orange	18
A06-93209-004	38L	Yellow	19

Table 11, Bulkhead Connector 1A, Dash Side for FL721-E

5. Crimp a Deutsch terminal 23-13210-210 to one end of 70 inches of wire 48-25428-142 and terminal 23-13215-402 to the other end. Mark the wire as 372P2.
6. Insert the Deutsch terminal end into cavity 16 of the Bulkhead connector.
7. Route the wire behind the dash to the Aux PDM behind the B-panel.
8. Insert the free end of the wire into cavity R6_87 in the auxiliary PDM.
9. Crimp terminal 23-13213-144 to one end of 34 inches of wire 48-25428-162 and terminal 23-13215-201 to the other end. Mark the wire as circuit 81C.
10. Insert one end into any free cavity in the ignition splice pack located behind the radio and the other end into cavity R6_85 in the auxiliary PDM.
11. Crimp terminal 23-13213-144 to one end of 32 inches of wire 48-25428-162 and terminal 23-13215-201 to the other end. Mark the wire as GND.
12. Insert one end into any free cavity in the ground splice pack located behind the radio and the other end into cavity R6_86 in the auxiliary PDM.
13. Crimp terminal 23-13215-301 to one end of 6 inches of wire 48-25428-142 and 23-13215-402 to the other end. Mark the wire as circuit 10A.
14. Insert one end into cavity F5_1 and the other into cavity R6_30 of the auxiliary PDM.

**February 2017
FL721A-E
NHTSA #16V-656
Transport Canada #16-441
REVISED NOTICE**

15. Insert a 20-amp mini fuse (23-12537-020) into fuse slot F5.
 16. Insert Micro relay 23-13265-010 into relay slot R6.
 17. Access the SAM Cab behind the glove box.
 18. Insert the free terminal on the end of harness A06-93208-000 into cavity 9 of SAM Cab connector 9B.
 19. Insert circuits 38R (dark green) and 38L (yellow) of harness A06-93208-000 into cavities 7 and 9 respectively in connector 53B (supplied loose in kit 23-13149-902). See [Fig. 6](#) and [Fig. 7](#).
 20. Snap the terminal lock and plug in the connector into cavity X53 on the SAM Chassis. See [Fig. 8](#).
 21. Remove connector 52B from slot X52 in the SAM Chassis.
 22. Unsnap the terminal lock. See [Fig. 9](#).
 23. Remove the wire in cavity 6 of connector 52B. Fold the wire back against itself, and cover the terminal with heat shrink tubing. See [Fig. 7](#).
 24. Label the wire with tape with the description "Removed for FL721."
 25. Insert circuit 376C (orange) from harness A06-93209-000 into cavity 6 on connector 52B. See [Fig. 7](#).
 26. Snap the terminal lock and plug the connector into slot X52 on the SAM Chassis.
 27. Plug the 4-wire connector on harness A06-93209-004 into slot X54 on the SAM Chassis.
 28. Plug the 4-wire connector on harness A06-93208-000 into slot x55 on the SAM Chassis. See [Fig. 10](#).
 29. Remove the green cover and grey terminal lock from the ABS ignition PLC filtered splice pack on harness A06-93209-004. See [Fig. 11](#).
 30. Insert the GT150S terminal end of the single wire harness A06-93668-000 into any available cavity in the splice pack. See [Fig. 12](#). Install the terminal lock and cover.
 31. Route the splice pack behind the ICU, near the radio. See [Fig. 13](#).
 32. Route wire behind the dash down to the ABS module. See [Fig. 18](#).
 33. Disconnect connector X1A from the ABS module and remove the terminal lock. See [Fig. 19](#) and [Fig. 20](#).
 34. Remove the existing wire from cavity 7 of ABS module connector X1A. See [Fig. 21](#) and [Fig. 22](#).
 35. Fold the removed wires back against themselves, and cover the exposed terminal ends with heat shrink tubing.
 36. Label the wire with tape with the description "Removed for FL721."
 37. Insert the free ends of single-wire harness A06-93668-000 into ABS module connector X1A, cavity 7. Connect A06-93668-000 into cavity 7. See [Fig. 35](#).
 38. Install the terminal lock in connector X1A and plug connector back into the ABS module.
 39. Use cable ties to secure the bundle to the HVAC ducting behind the ICU. See [Fig. 24](#).
 40. Outside the cab, disconnect the chassis PDM (CPDM) harness and cap it with 23-13153-011. Plug each cavity with a cavity plug (23-13218-300). See [Fig. 25](#), [Fig. 26](#), and [Fig. 27](#).
- NOTE: Remove MEGA fuses from the PNDB if there are no other cables populated on the studs.
41. Disconnect the CPDM power cable from the PNDB and remove it from the vehicle. See [Fig. 28](#). Replace any cable ties that were removed, which are still needed to secure other hoses and wiring.
- NOTE: The CPDM should be discarded after it is removed from the vehicle. It will not be used again.
42. Remove the CPDM from the vehicle. See [Fig. 29](#).
 43. Wrap the sections of A06-93018-084 and A06-93164-058 that are not protected with convoluted tubing with fiber wrap tape (48-25910-003). See [Fig. 30](#).

**February 2017
FL721A-E
NHTSA #16V-656
Transport Canada #16-441
REVISED NOTICE**

- 44. Insert the end of A06-93268-024 into cavity D of the 4 wire connector on A06-93164-024.
- 45. Crimp terminal 23-13213-121 and seal 23-12497-000 to one end of 36 inches of wire 48-25428-141 and ring terminal 23-11194-514 to the other end. Protect the crimped portion of the ring terminal with heat shrink tubing (48-02461-038).

46. Insert the terminal end into cavity B of the 4 pin connector on harness A06-93164-024.

NOTE: Leave the ring terminal wire loose.

47. Wrap the sections of A06-93268-024, A06-93018-024 and A06-93164-024 that are not protected with convoluted tubing with fiber wrap tape (48-25910-003).

NOTE: Route the harness safely away from sharp points and edges, moveable parts, and other possible sources of abrasion, cutting, pinching, or crushing. Secure it to the frame rail at regular intervals using zip ties fastened to standoffs. Whenever possible, the harness should be routed behind the air and hydraulic lines.

48. Route harnesses A06-93268-024, A06-93018-024, and A06-93164-024 along the frame rail to bulkhead module connector 1A. See [Fig. 31](#).

49. Insert the terminals into their respective cavities in the engine side 1A bulkhead connector. See [Table 12](#).

Bulkhead Connector 1A, Engine Side for FL721-E			
Harness	Circuit	Color	Cavity
A06-93164-024	376F	Orange	1
A06-93164-024	23A	Brown	6
A06-93164-024	46A	Brown	7
A06-93164-024	45	Dark Blue	10
A06-93164-024	36B	Red/White Stripe	12
A06-93164-024	38R	Dark Green	17
A06-93164-028	376E	Orange	18
A06-93209-004	38L	Yellow	19

Table 12, Bulkhead Connector 1A, Engine Side for FL721-E

NOTE: The bulkhead connector is keyed with one flat side to be aligned with the D-shape in the front wall hole.

50. Connect the 1A bulkhead connector.

NOTE: The old harness that the primary receptacle harness was plugged into does not need to be capped and can stay where it sits in the frame rail.

51. Unplug the existing primary receptacle harness along the frame rail near the back of the cab.

February 2017
 FL721A-E
 NHTSA #16V-656
 Transport Canada #2016-441
 REVISED NOTICE

52. Cut the primary receptacle connectors off and populate with terminals, seals, and connectors as shown in [Table 13](#), [Fig. 36](#) and [Fig. 37](#).

Primary Receptacle Connectors					
Receptacle	Wire Color	Seal	Terminal	Connector	Terminal Lock
Primary	Red	23-12497-010	23-13213-332	23-13302-033	23-13142-218
	Blue	23-12497-010	23-13213-332	23-13302-033	23-13142-218
	Yellow	23-12497-001	3-13213-131	23-13302-091	23-13142-404
	Brown	23-12497-001	3-13213-131	23-13302-091	23-13142-404
	Green	23-12497-001	3-13213-131	23-13302-091	23-13142-404
	Black	23-12497-001	3-13213-131	23-13302-091	23-13142-404
Supplemental	White/Green	23-12497-010	23-13213-332	23-13302-033	23-13142-218
	White/Red	23-12497-009	23-13213-330	23-13302-033	23-13142-218
	White/Black	23-12497-000	23-13213-131	23-13302-091	23-13142-404
	White/Orange	23-12497-000	23-13213-131	23-13302-091	23-13142-404
	White/Blue	23-12497-000	23-13213-131	23-13302-091	23-13142-404
	White/Yellow	23-12497-000	23-13213-131	23-13302-091	23-13142-404

Table 13, Primary Receptacle Connectors

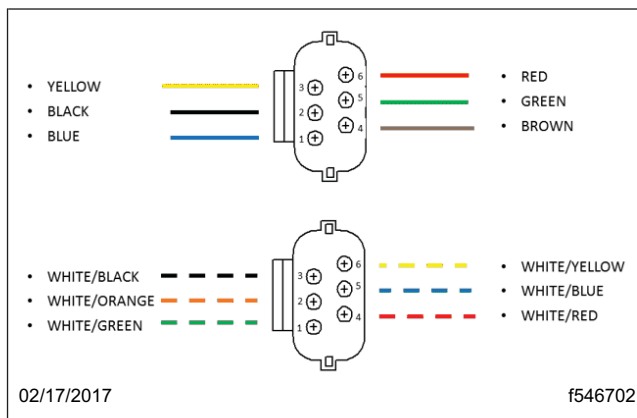

Fig. 36, Pinning From

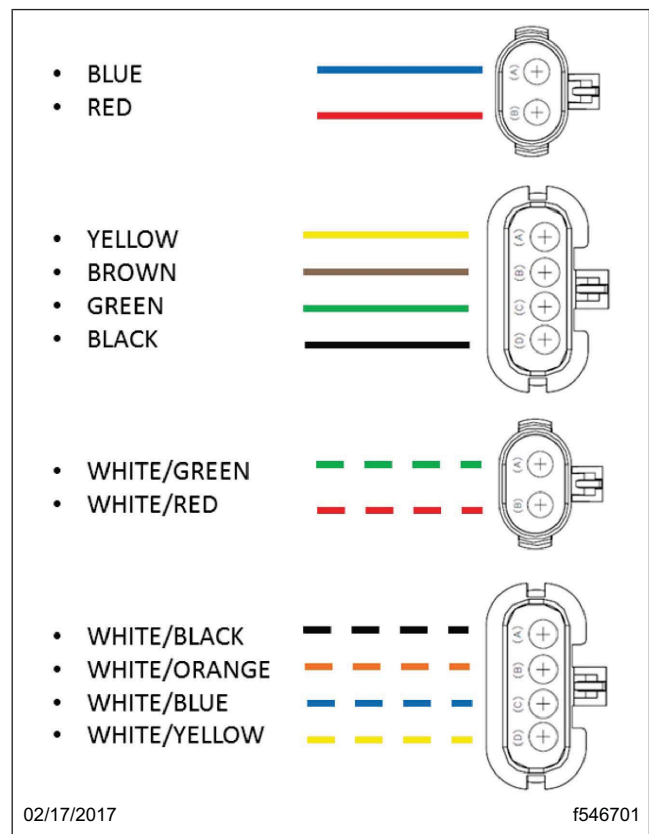

Fig. 37, Pinning To

February 2017
FL721A-E
NHTSA #16V-656
Transport Canada #2016-441
REVISED NOTICE

53. Bolt the ground eyelets to the frame reusing the same bolts as the old receptacle ground wires and coat with dielectric red enamel spray or paint (48-25901-000, or equivalent).
54. Install relay 23-11276-020 (vendor p/n 896-1AH-C-R1-U03-12VDC) into cavity R8, 23-11276-011 (vendor p/n 896-ACH-C-R-U03-12VDC) into cavity R6, and a 30-amp fuse into cavity F11 of the SAM Chassis. See [Fig. 33](#).
55. Connect the battery cables.
56. Check parameters and verify that the following are set:
 - **Backup Lamps:** A0004471361-001 PARM-CHAS,BLK,BKS,MAN,AUT
 - **End-of-Frame Receptacle Power:** A0004478661-001 PARM-CHAS,EOF,SUP-R,NO CNT
 - **Trailer Configuration:** A0014470261-001 PARM-CHAS,TRA,BOC,IGN
57. Verify that the primary receptacle ([Fig. 34](#)) is functioning properly by performing the following checks with the ignition key in the ON position:
 - 57.1 Verify there is battery voltage on the Black terminal while the marker lamps are turned on.
 - 57.2 Verify there is battery voltage on the Brown terminal while the headlamps are turned on.
 - 57.3 Verify there is battery voltage on the Green terminal while the right turn signal is activated.
 - 57.4 Verify there is battery voltage on the Red terminal while the service brake is activated.
 - 57.5 Verify there is battery voltage on the Blue terminal at all times.
 - 57.6 Verify there is battery voltage on the Yellow terminal while the left turn signal is activated.
 - 57.7 If any circuits don't have power when they should, troubleshoot the circuit.
58. Install the kick panel, ICU, lower dash cover, and any dash panels that were removed.
59. Go to step 4 of the General Procedure on page 8.