

December 19, 2015

02517 Version 2

## Safety Recall: Front Passenger's Airbag Inflator Can Be Over-Pressurized

Supersedes 15-067, dated October 1, 2015, to revise the information highlighted in **yellow**  
 Replaces 13-034, *Safety Recall: Front Passenger's Airbag Inflator Can Be Over-Pressurized*  
 Replaces 14-040, *Safety Recall: Front Passenger's Airbag Inflator Can Be Over-Pressurized*  
 Replaces 15-041, *Safety Recall: Front Passenger's Airbag Inflator Can Be Over-Pressurized*

### REVISION SUMMARY

- 2004 CR-V models were added to this safety recall.
- A new video about counterfeit airbags was added to the **REPAIR PROCEDURE**.

### AFFECTED VEHICLES

Year	Model	Trim	VIN Range
2003–07	Accord	ALL	Check the iN VIN status for eligibility
2001–05	Civic	ALL	Check the iN VIN status for eligibility
2001–04	Civic GX	ALL	Check the iN VIN status for eligibility
2003–05	Civic Hybrid	ALL	Check the iN VIN status for eligibility
<b>2002-04</b>	CR-V	ALL	Check the iN VIN status for eligibility
2003	Element	ALL	Check the iN VIN status for eligibility
2002-03	Odyssey	ALL	Check the iN VIN status for eligibility
2003	Pilot	ALL	Check the iN VIN status for eligibility

### BACKGROUND

American Honda consolidated some models from the previous airbag inflator campaigns into this current bulletin based on information from NHTSA. Do an iN VIN status inquiry and, if indicated, repair the vehicle.

In certain vehicles, the front passenger airbag inflator could produce excessive internal pressure during airbag deployment. If an affected airbag deploys, the increased internal pressure may cause the inflator casing to rupture. Metal fragments could be propelled upward toward the windshield, or downward toward the front passenger's foot well, possibly causing an injury to vehicle occupants.

**NOTE: If the VIN status inquiry indicates that the vehicle is subject to any open safety recalls, including a driver's airbag inflator campaign/recall, make sure to also complete those recall repairs before returning the vehicle to the customer. If you are unable to complete any open recall, advise the customer of the recall status and when the recall may be completed.**

New and different inflators are available. You may receive a different part number than ordered, and the inflator may physically look different from previous replacement parts. As a result, there may be different installation instructions. Make sure you review this service bulletin for installation instructions and details about model applicability. PARTS INFORMATION and REPAIR PROCEDURE were updated to reflect these new parts.

A new inflator has been added to the video included in this bulletin.

On June 18, 2015, there was a change in the return process for driver and front passenger inflators. Refer to the PIB A15-0002, *Inflator Kit Return Process* for more information.

**CUSTOMER INFORMATION:** The information in this bulletin is intended for use only by skilled technicians who have the proper tools, equipment, and training to correctly and safely maintain your vehicle. These procedures should not be attempted by "do-it-yourselfers," and you should not assume this bulletin applies to your vehicle, or that your vehicle has the condition described. To determine whether this information applies, contact an authorized Honda automobile dealer.

On September 16, 2015, new processes for handling airbag inflators were introduced. Refer to the **Ordering and Managing Replacement Inflators** for more information on ordering and handling airbag inflators at your dealership. You can find the instructions in two places:

- On SIS, select **Search By Vehicle**, then **Technical Library**. Enter keyword **INFLATOR** and select **Job Aids**. Select **Ordering and Managing Replacement Inflators** from the list.
- From the iN, select **Service, Warranty**, then **Claims Reference Guide**. Under **HOT TIPS/TOPICS**, select **Ordering and Managing Replacement Inflators**.

## CUSTOMER NOTIFICATION

Owners of affected vehicles will be sent a notification of this campaign.

Do an iN VIN status inquiry to make sure the vehicle is shown as eligible.

Some vehicles affected by this campaign may be in your used vehicle inventory. These vehicles must be repaired before they are sold.

Should your dealership sell an unrepaired vehicle that subsequently causes injury or damage because of the recalled item, the dealership will be solely responsible to the damaged party, and will be required to defend and indemnify American Honda for any resulting claims. To see if a vehicle in inventory is affected by this recall, do a VIN status inquiry before selling it.

## CORRECTIVE ACTION

Replace the passenger's airbag inflator, then return the original, undeployed inflator as directed.

## PARTS INFORMATION

Part Name	Part Number Ordered	You may receive any of the following	Quantity
2003 Accord Front Passenger's Airbag Inflator Kit	04785-SDA-307	04785-SDA-307 04790-SDA-308	1
2004–07 Accord Front Passenger's Airbag Inflator Kit	04785-SDA-306	04785-SDA-306 04790-SDA-305	1
2001–05 Civic (includes GX and Hybrid) Front Passenger's Airbag Inflator Kit	04785-S5A-307	04785-S5A-307 04790-S5A-308	1
2002–04 CR-V Front Passenger's Airbag Inflator Kit	04785-S9A-307	04785-S9A-307 04790-S9A-308	1
2003 Element Passenger (Front) Airbag Inflator Kit	04785-SCV-307	04785-SCV-307 04790-SCV-308	1
2002 Odyssey Front Passenger's Airbag Inflator Kit	04785-S0X-307	04785-S0X-307 04790-S0X-308	1
2003 Odyssey Passenger (Front) Airbag Inflator Kit	04785-S0X-306	04785-S0X-306 04790-S0X-305	1
2003 Pilot Passenger (Front) Airbag Inflator Kit	04785-S9V-307	04785-S9V-307 04790-S9V-308	1

### NOTE:

- The inflator kit box must be used to return the recalled inflator to its supplier. Be careful not to damage the inflator kit box.
- If the recalled, undeployed inflator is not returned, the warranty claim for that vehicle will be charged back to your dealership.
- To return the undeployed inflators, follow the shipping instructions outlined in PIB A15-0002, *Inflator Kit Return Process*.
- Parts staff can scan the part number and serial number from the outside of the box into the warranty claim by using the Controlled Part Serial No. screen and scanning the applicable information. Refer to the Job Aid **Ordering and Managing Replacement Inflators** for more information.

## WARRANTY CLAIM INFORMATION

### NOTE:

- Process claims as quickly as possible so that resources can be properly allocated.
- Enter the part number of the inflator that you received into the warranty claim, **not the part number that you ordered**. For more information, refer to step 6 of REPAIR PROCEDURE.
- To avoid non-payment of warranty claims, the serial number on the box of the new airbag inflator must be entered in the warranty claim. For more information, refer to step 6 of REPAIR PROCEDURE.
- To avoid a warranty claim being charged back to your dealership, you must return the original undeployed inflator to its supplier. Follow the shipping instructions outlined in PIB A15-0002, *Inflator Kit Return Process*.
- The serial number is encoded into the bar code printed on the label inside of the box and on a label attached to the outside of the box. If your dealership uses a scanner, you can scan the serial number from either place into the claim.
- The part number is encoded into a barcode attached to the outside of the box. If your dealership uses a scanner, you can scan the part number into the claim.
- **If you confuse the serial number and part number when entering the claim information, your claim will automatically be rejected.**
- For more information about scanning and filing airbag inflator recall claims, refer to **Ordering and Managing Replacement Inflators**. From the iN, select **Service, Warranty**, then **Claims Reference Guide**. Under **HOT TIPS/TOPICS**, select **Ordering and Managing Replacement Inflators**.

### Replacing the front passenger's airbag inflator

Year/ Model	Operation Number	Replacement Part number	Flat Rate Time	Defect Code	Symptom Code	Template ID	Failed Part Number
2003 Accord	7541B6	04785-SDA-307	0.7 hr	5SK00	JU400	15-067A	06780-SDN-A90ZA
		04790-SDA-308	0.7 hr	5SK00	JU400	15-067B	06780-SDN-A90ZA
2004–07 Accord	7541B6	04785-SDA-306	0.7 hr	5SK00	JU400	15-067C	06780-SDN-A90ZA
		04790-SDA-305	0.7 hr	5SK00	JU400	15-067D	06780-SDN-A90ZA
2001–05 Civic	7541B6	04785-S5A-307	0.7 hr	5SK00	JU500	15-067E	06780-S5A-A80ZA
2001–04 Civic GX		04790-S5A-308	0.7 hr	5SK00	JU500	15-067F	06780-S5A-A80ZA
2003–05 Civic Hybrid							
2002–04 CR-V	7521F7	04785-S9A-307	0.7 hr	5SK00	JU600	15-067G	06780-S9A-A80ZA
	7521F7	04790-S9A-308	0.7 hr	5SK00	JU600	15-067H	06780-S9A-A80ZA
2003 Element	7541A9	04785-SCV-307	0.8 hr	5SK00	JU700	15-067K	06780-SCV-A80ZA
	7541A9	04790-SCV-308	0.8 hr	5SK00	JU700	15-067L	06780-SCV-A80ZA
2002 Odyssey	7541A0	04785-S0X-307	0.7 hr	5JK00	JU800	15-067M	06780-S0X-A10ZA
	7541A0	04790-S0X-308	0.7 hr	5JK00	JU800	15-067N	06780-S0X-A10ZA
2003 Odyssey	7541A0	04785-S0X-306	0.7 hr	5JK00	JU800	15-067O	06780-S0X-A10ZA
	7541A0	04790-S0X-305	0.7 hr	5JK00	JU800	15-067P	06780-S0X-A10ZA
2003 Pilot	7541A0	04785-S9V-307	0.8 hr	5JK00	JU900	15-067Q	06780-S9V-A80ZA
	7541A0	04790-S9V-308	0.8 hr	5JK00	JU900	15-067R	06780-S9V-A80ZA

Skill Level: Repair Technician

## REPAIR PROCEDURE

### NOTE:

- If the VIN status inquiry indicates that the vehicle is subject to any open safety recalls, including a driver's airbag inflator campaign/recall, make sure to also complete those recall repairs before returning the vehicle to the customer. If you are unable to complete any open recall, advise the customer of the recall status and when the recall could be completed.
  - Make sure you have the anti-theft code for the audio and navigation system (if applicable), then write down the frequencies for the audio unit's preset buttons.
  - Be careful not to damage any parts when replacing the inflator, and **follow the procedure exactly**.
  - If, before removing the airbag, you suspect that it may be the incorrect airbag for the vehicle or a counterfeit, **do not remove the airbag**. Contact your DPSM for assistance.
  - Make sure you have reviewed the SRS Precautions and Procedures in the service repair information before doing the REPAIR PROCEDURE.
1. Turn the ignition switch to the ON (II) position and check if the SRS indicator comes on for about 6 seconds, then turns off.
    - If the indicator comes on, then turns off after about 6 seconds, go to step 2.
    - If the indicator does not come on, or if it stays on, contact your DPSM for assistance.
  2. Disconnect the battery negative cable and wait at least 3 minutes before continuing.
  3. Remove the front passenger's airbag. Refer to the service repair information.
  4. Place the airbag, face-down, on a clean shop towel.

### NOTE:

- The orientation of the airbag is critical because if the inflator is installed incorrectly, the harness will be too short when you reinstall the airbag.
- The brackets between the various models are similar but may differ from the example shown.



5. Visually inspect the airbag and the inflator for any unusual writing or markings.

## “IDENTIFYING COUNTERFIT AIRBAGS” VIDEO



- If there is nothing unusual about the airbag or the inflator, go to step 6.
- If there are any unusual markings, like an incorrect label or a model year written in marker, the airbag and inflator may not be the correct airbag and/or inflator for the vehicle or it may be a counterfeit part. For more information about counterfeit airbags, you can refer to [safercar.gov](http://safercar.gov), enter keywords **MANAGING COUNTERFEIT**, and select **Recommended Dealer Guidance for Managing Counterfeit Air Bags** from the list. **If you suspect that the airbag or inflator is counterfeit, do not continue this procedure.** Contact your DPSM for assistance.

NON-STANDARD SAFETY LABEL

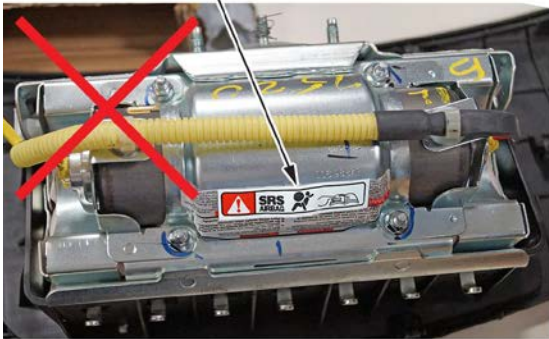

GREASE PENCIL OR PAINT MARKINGS

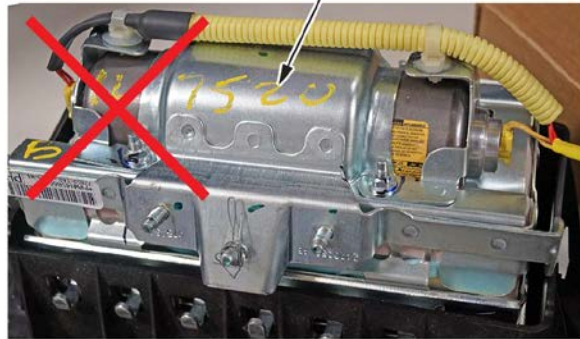

HAND ENGRAVING



NO LABELS ON INFLATOR

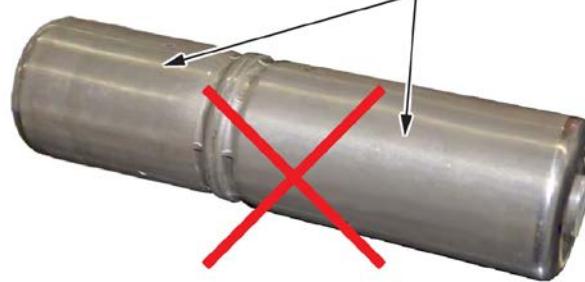

6. Peel the label located inside the inflator box from its backing and attach it to the RO. For the warranty claim to be paid, the **replacement inflator part number that you received** must be included in the warranty claim.

NOTE:

- The replacement part number is printed on the top part of the label and the serial number is printed on the bottom. **Make sure you attach the label to the RO and give it to the warranty clerk.**
- There may also be a colored sticker located in the kit; ignore it because it is not used.
- Not all inflator kits have a label included. In those cases, write the serial number and part number from the side of the inflator box on the RO. The part number always starts with 047.

**PASSENGER INFLATOR PARTS BOX**

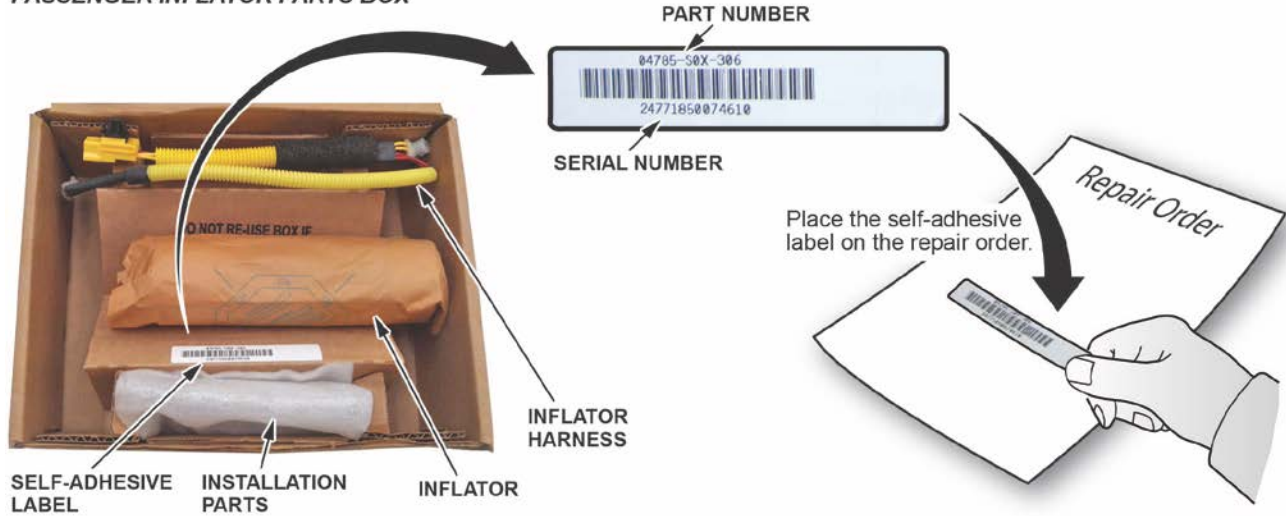

7. Remove the harness from both ends of the inflator brackets.

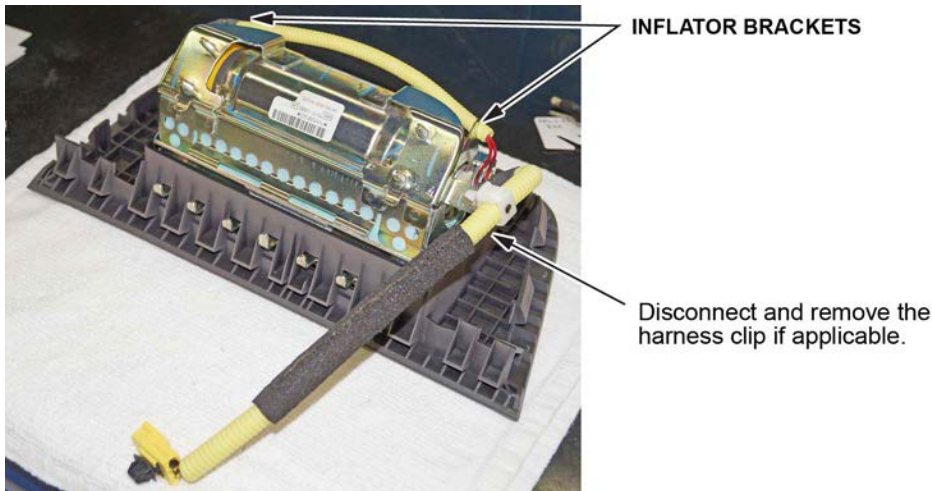

8. Short the red wires.

NOTE: **You must cut and short the wires** as indicated to prevent accidental deployment.

- Cut the red wires as shown.

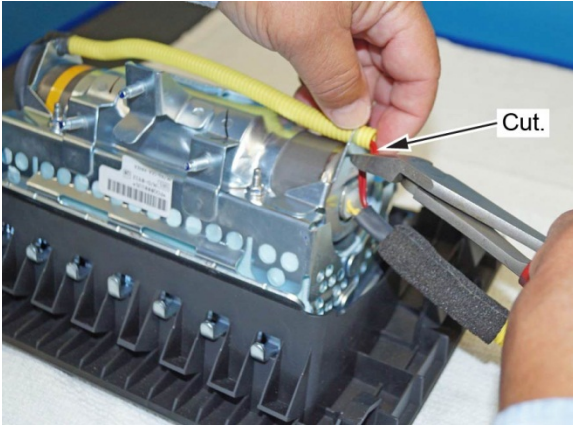

- Cut about 2 inches of the corrugated tube, then pull out the two red wires.

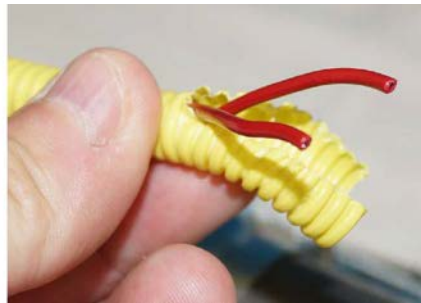
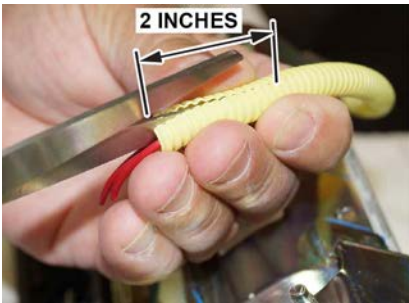

- Strip away about 1 inch of the wire insulation, then twist the wires together.

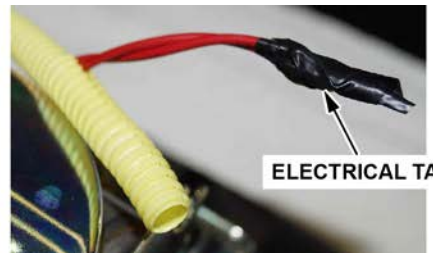
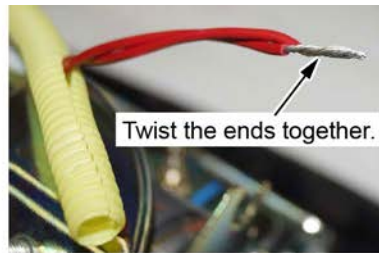

- Tape the twisted ends with electrical tape.

9. Cut off the connector and short the yellow wires.

NOTE: **You must cut and short the wires** as indicated to prevent accidental deployment.

- Cut all four wires to remove the connector.

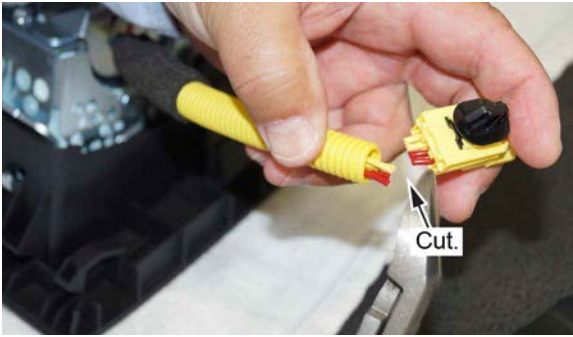

- Cut about 2 inches of the corrugated tube, then pull out the yellow wires.

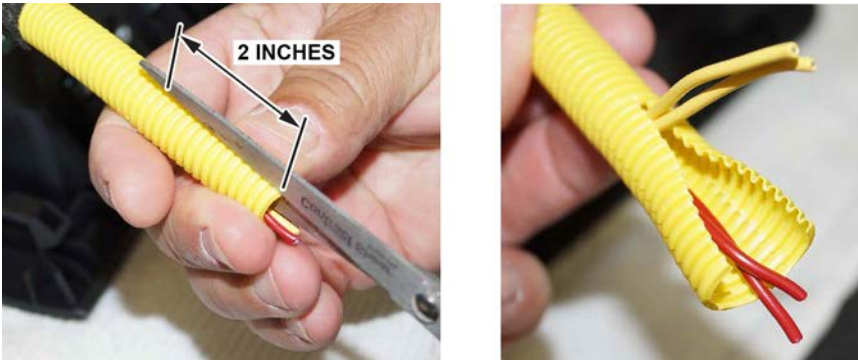

- Strip away about an inch of the wire insulation, then twist the wire ends together.

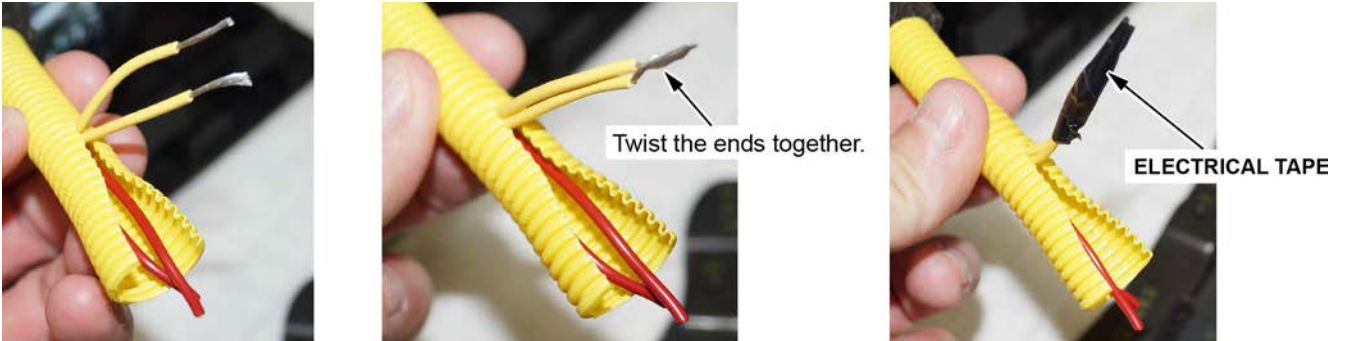

- Tape the twisted ends with electrical tape.

10. Remove the four inflator nuts.

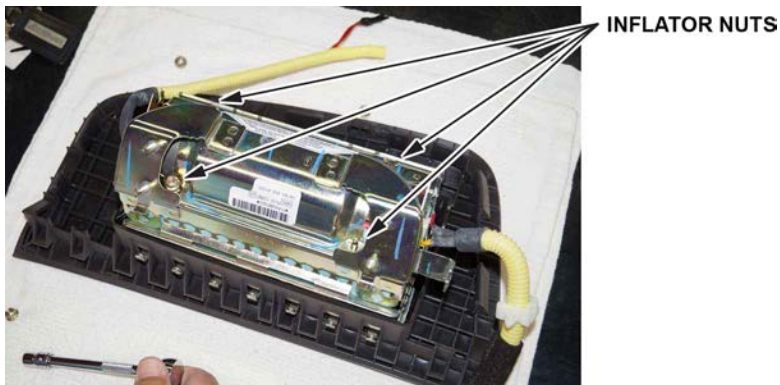



11. Remove the inflator bracket.

NOTE: You can only remove one of the brackets, as the other is welded to the airbag housing.

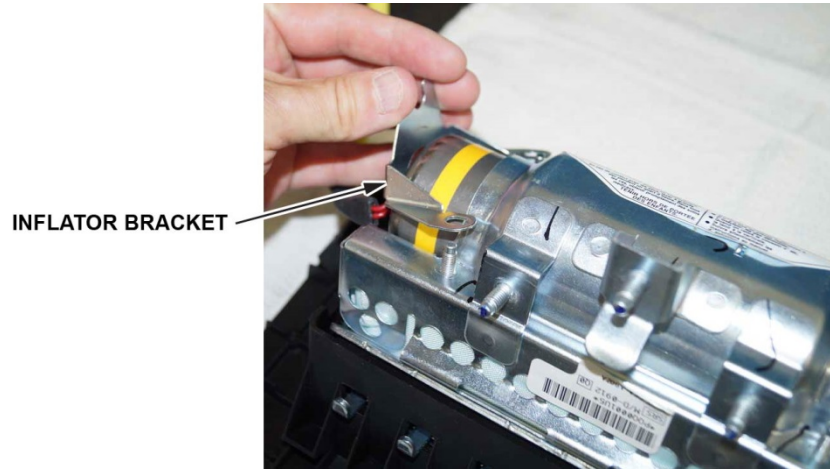

12. Remove the inflator by pushing it out.

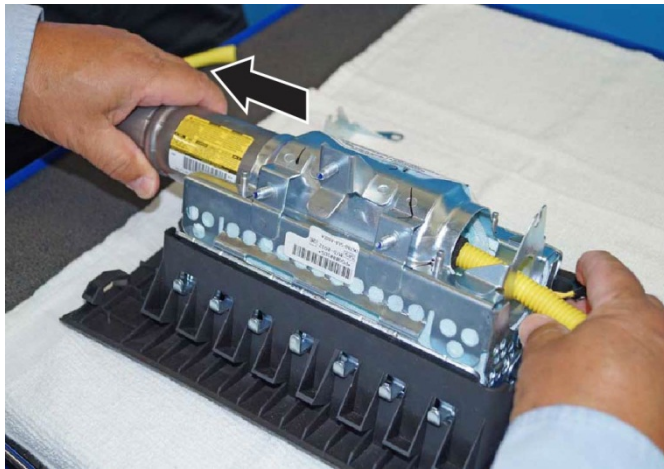

13. Install the new inflator.

Click on the image below for a short video about the different variations of the driver's and front passenger's replacement inflators involved with the recalls related to inflators. While both the driver's and front passenger's inflators are shown in the video, this is informational only. Replace inflators only as directed by the iN VIN status inquiry.



**Check your part number against the ones listed for each installation procedure. Use the correct installation procedure for the part you received.**

**Part Number**

- 04785-SDA-307
- 04785-S5A-307
- 04785-SDA-306
- 04785-S9A-307
- 04785-SCV-307
- 04785-S0X-307
- 04785-S0X-306
- 04785-S9V-307

- One connector looks like a “D” whereas the other connector is a circle. Make sure you insert the “D” shaped terminal into the airbag first.

NOTE: There is a yellow band marking on the circle side.

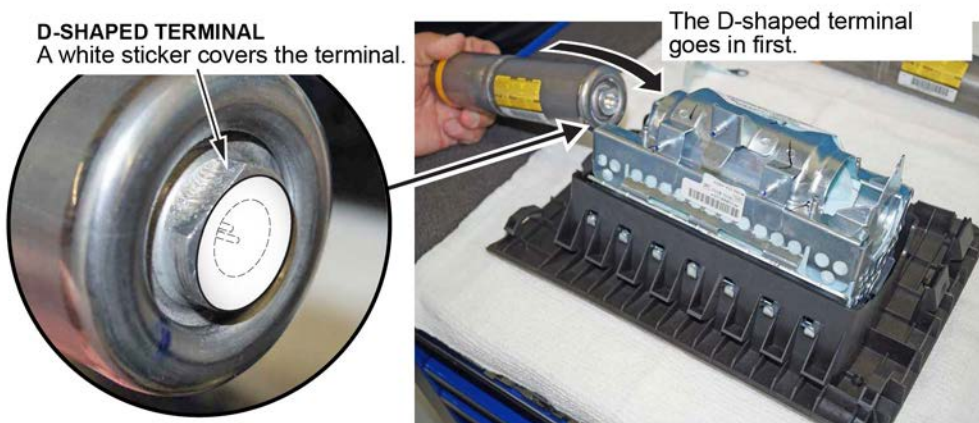

- Slide the inflator in until the “D” aligns with the tab on the inflator bracket. There should be no space or gap between the inflator and bracket.

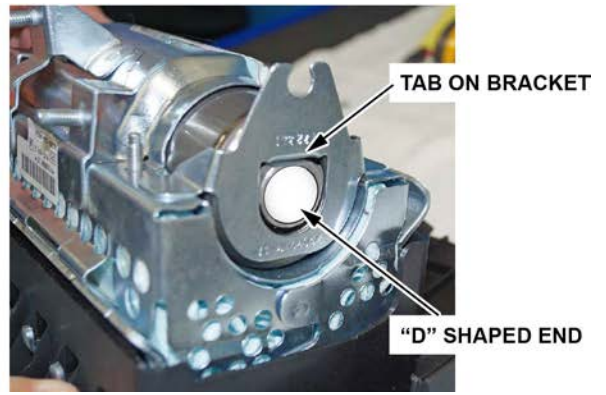

- Reinstall the inflator bracket. There should be no space or gap between the bracket and inflator.

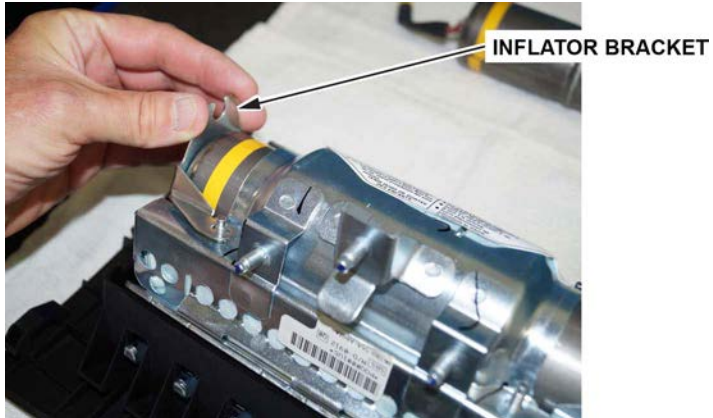

Check your part number against the ones listed for each installation procedure. Use the correct installation procedure for the part you received.

**Part Number**

- 04790-SDA-308
- 04790-S5A-308
- 04790-SCV-308
- 04790-S9A-308
- 04790-S0X-308
- 04790-S9V-308

- One side of the inflator has a longer collar, a longer tab, a plastic cutout, and a small flat spot on the connector. The other side of the inflator has a shorter collar, a shorter tab, and a red dot. Make sure you insert the end with the longer collar into the airbag first.

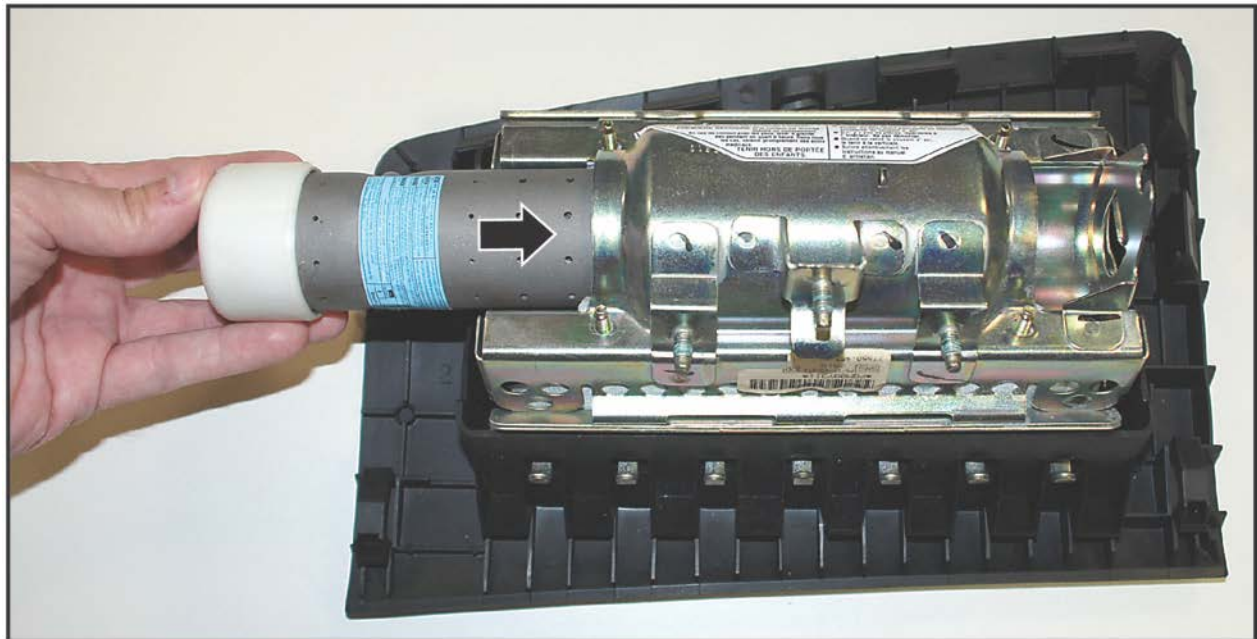
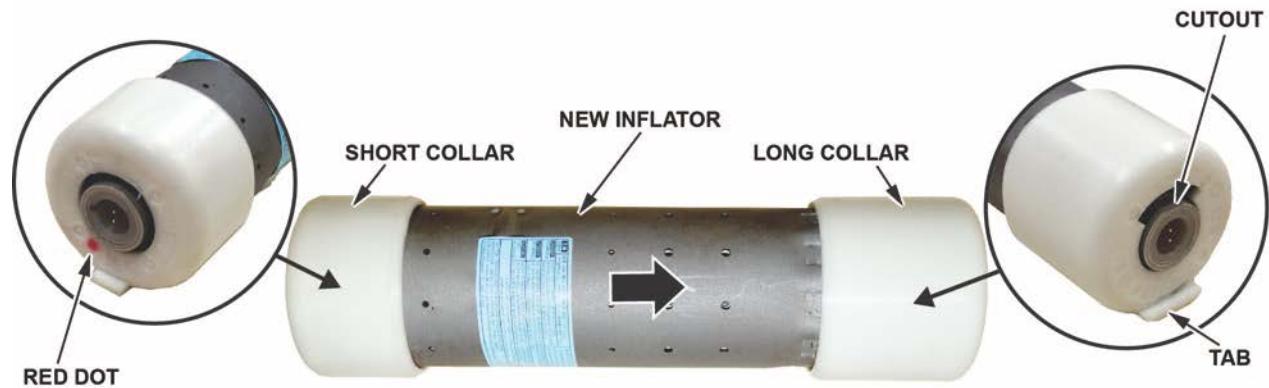

- Slide the inflator in until the plastic cutout and the small flat spot align with the tab on the bracket. There should be no space or gap between the inflator and bracket.

**FIXED BRACKET END**

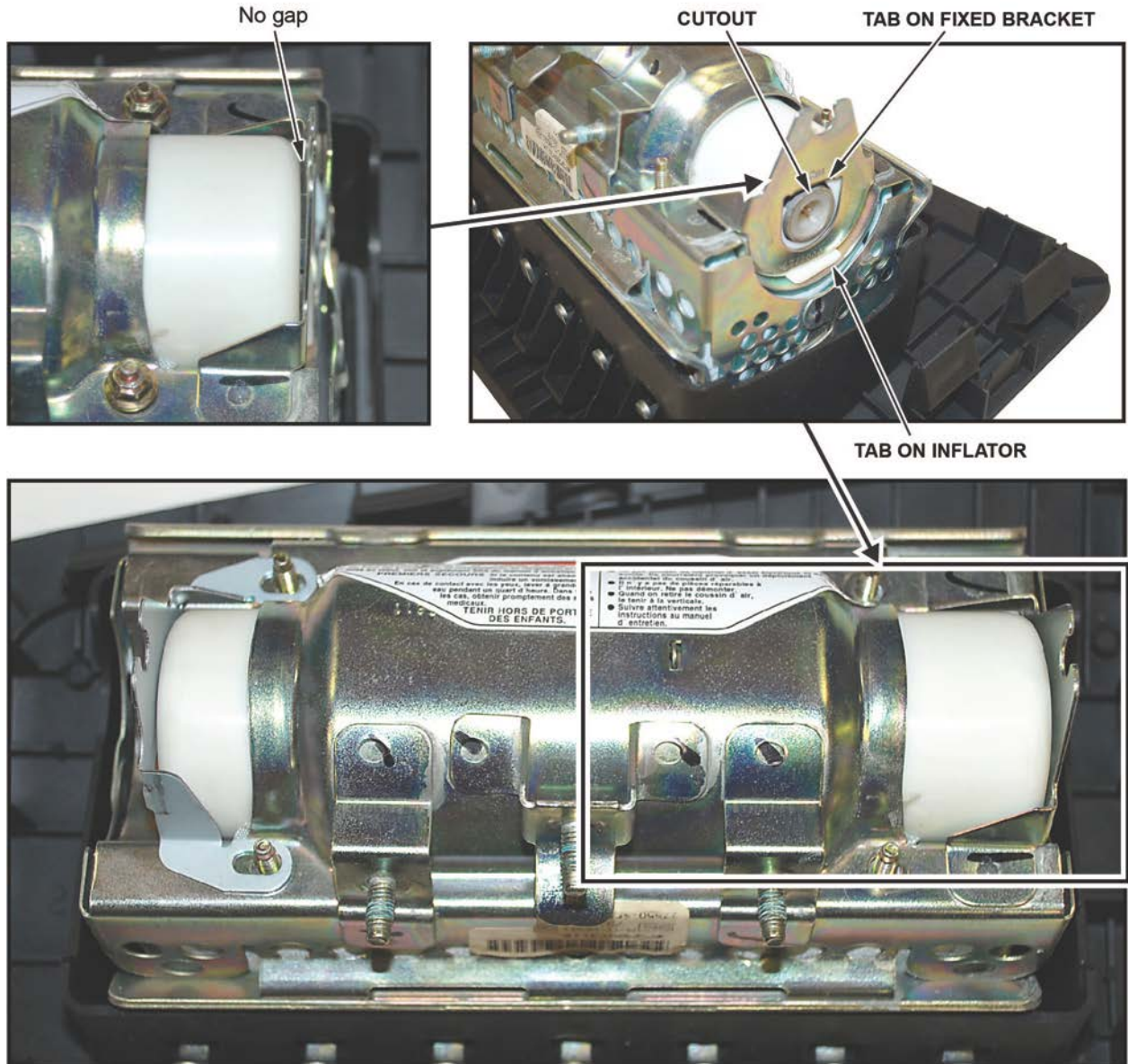

- Install the bracket included in the kit onto the airbag module. There should be a red dot visible on the end of the plastic connector. There should be no space or gap between the inflator and bracket.

**ADJUSTABLE BRACKET END**

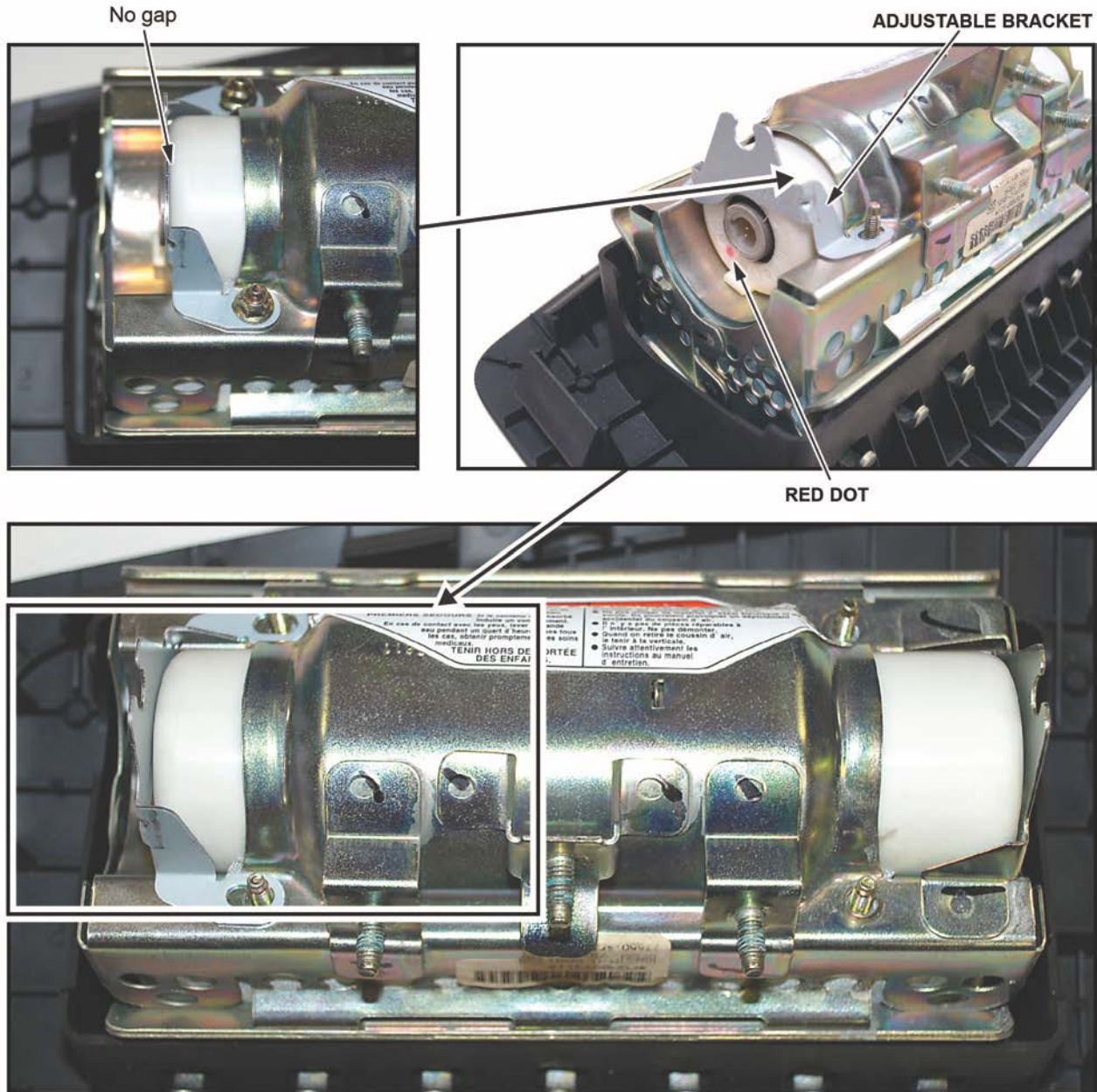

Check your part number against the ones listed for each installation procedure. Use the correct installation procedure for the part you received.

**Part Number**

04790-SDA-305

04790-SOX-305

- collars on this inflator are orange, not white. One side of the inflator has a longer collar, a tab, a plastic cutout, and a small flat spot on the connector. The other side of the inflator has a shorter collar, no tab, and a red dot. Make sure you insert the end with the longer collar into the airbag first.

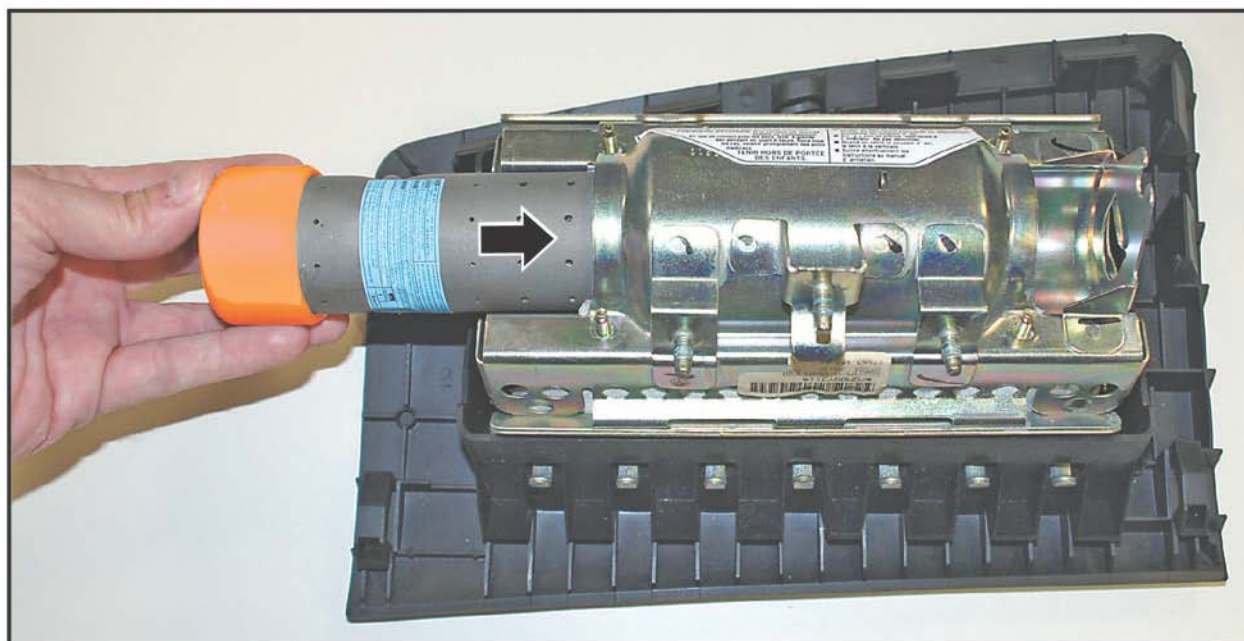
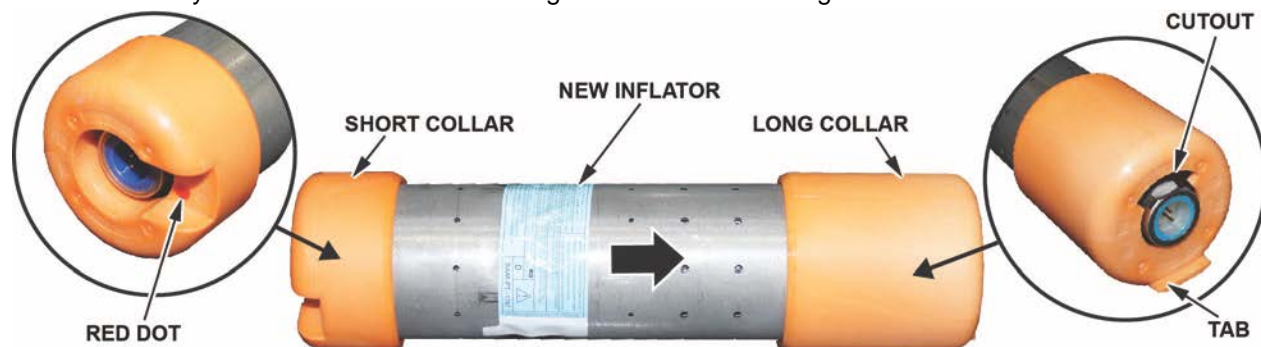

- Slide the inflator in until the plastic cutout and the small flat spot align with the tab on the bracket. There should be no space or gap between the inflator and bracket.

**FIXED BRACKET END**

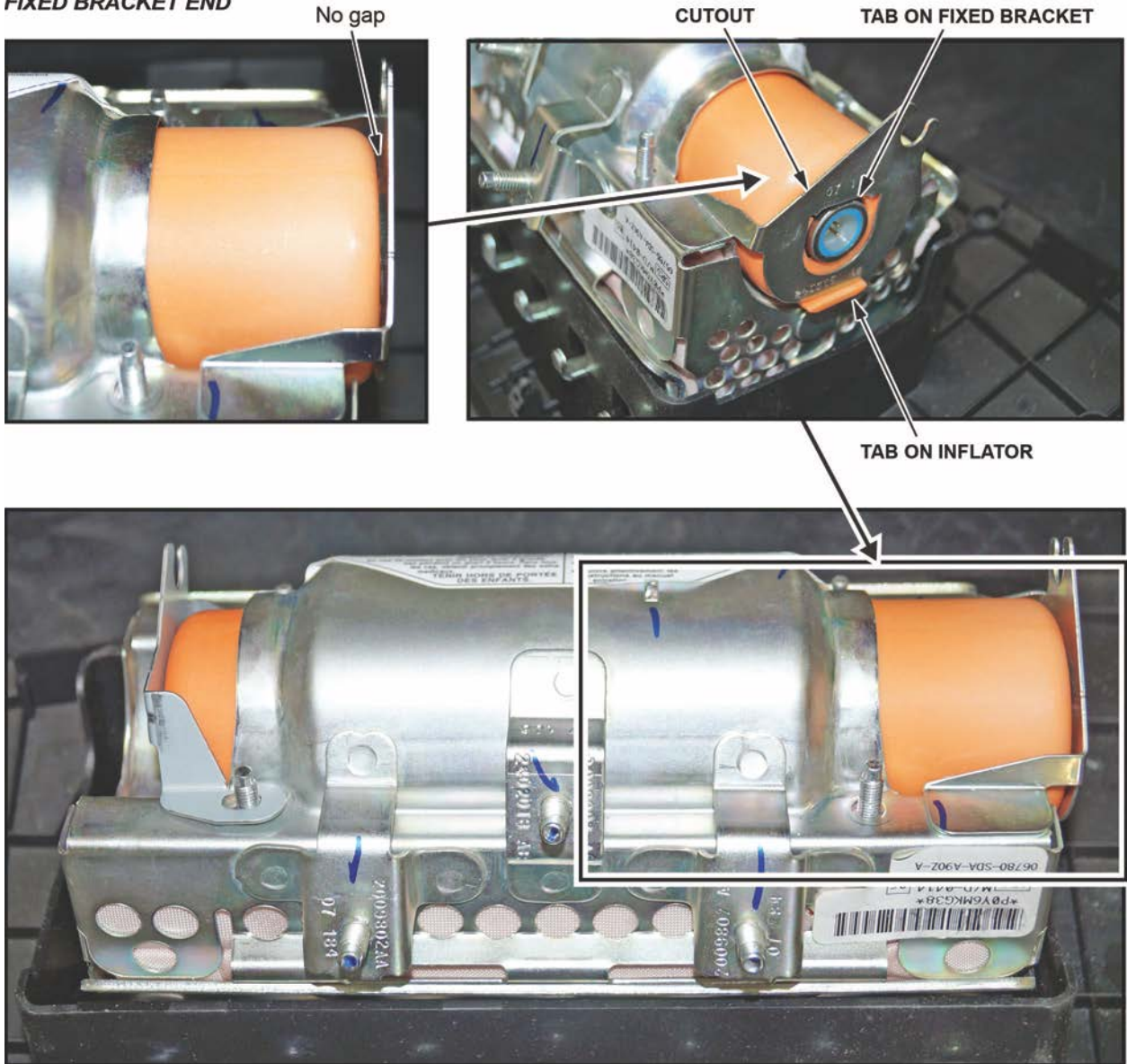



- Install the bracket included in the kit onto the airbag module. There should be a red dot visible on the end of the plastic connector. There should be no space or gap between the inflator and bracket.

**ADJUSTABLE  
BRACKET END**

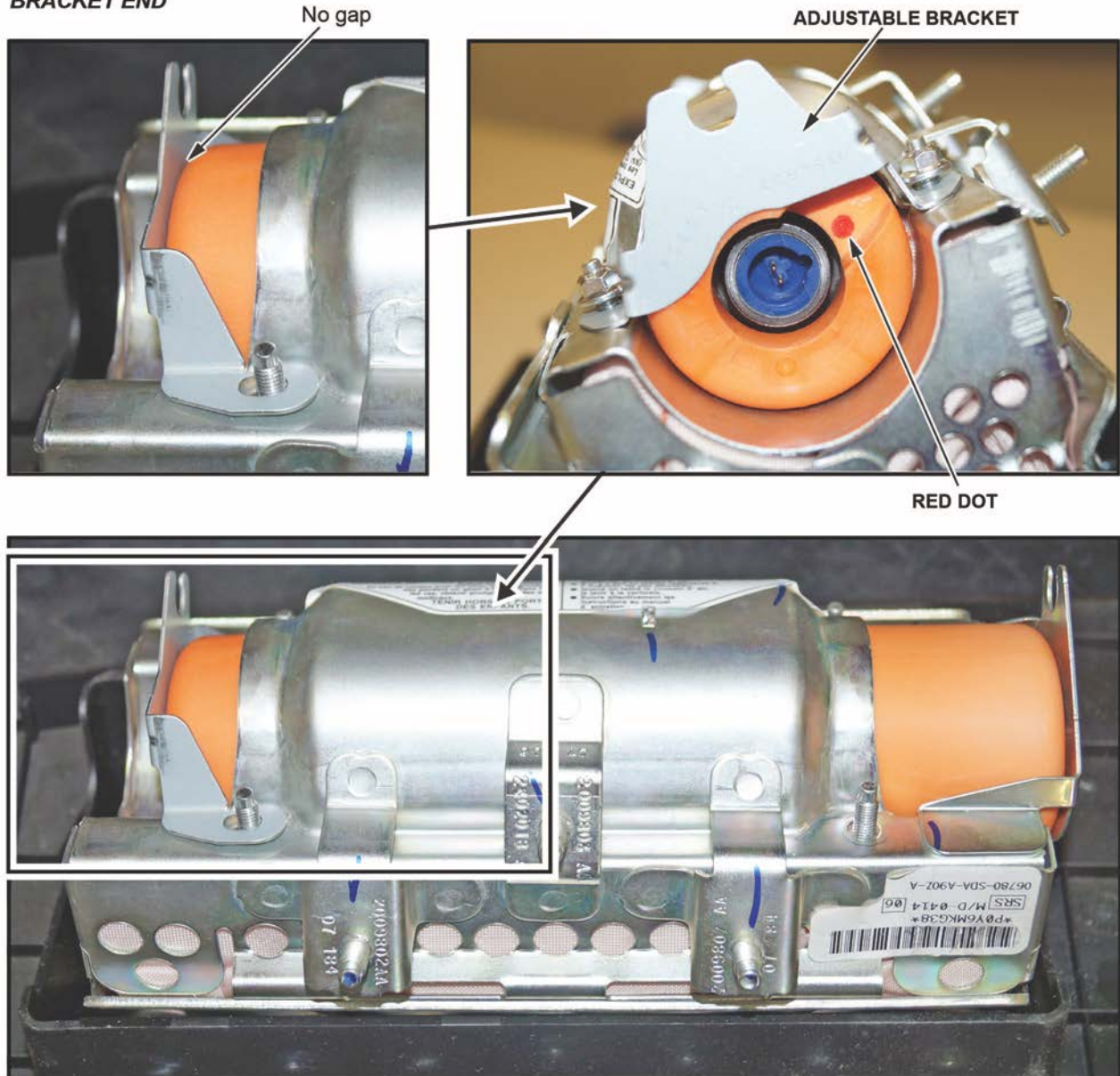

14. Install the new 5 mm locknuts and torque them in sequence to **3.9 N•m (34 lb-in)**.

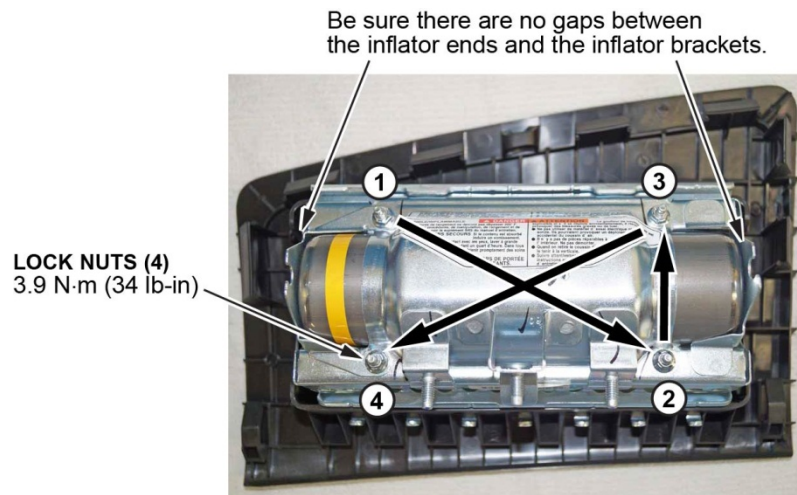

15. Remove the stickers covering the terminals on both sides of the new inflator.

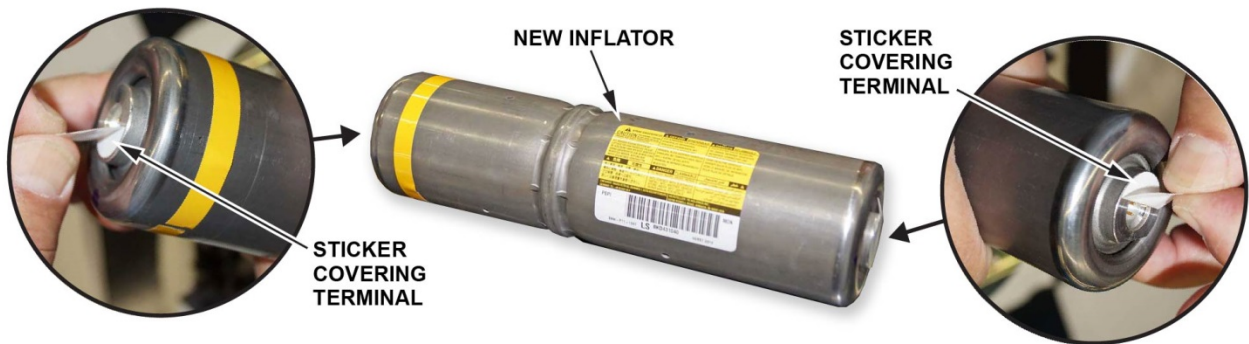

16. Install the new inflator harness.

- Make sure the airbag and harness are aligned as shown.

NOTE:

- **Make sure you have the orientation correct as shown below.** If you connect the harness incorrectly, the harness cannot be removed, and you will not be able to reinstall the airbag because the harness will be too short.
- On the replacement inflators with plastic collars, connect the red wire connector to the connector with the red dot.
- On the replacement inflators without plastic collars, connect the red wire connector to the connector nearest the yellow band.

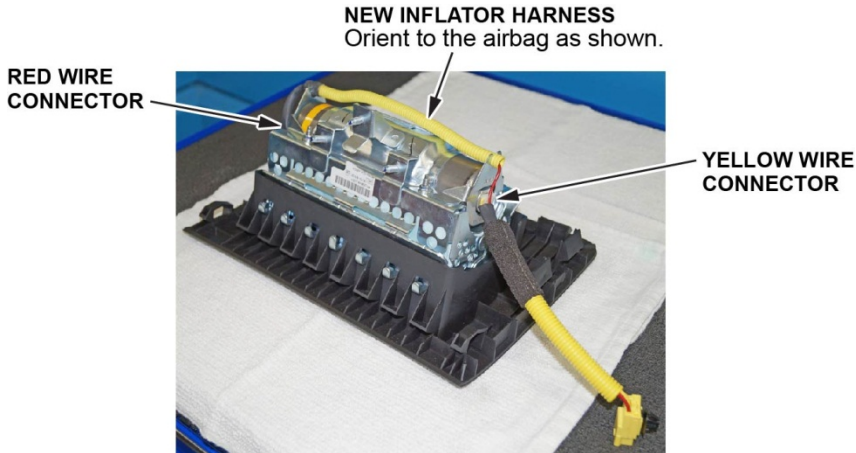

- Connect the two connectors. Align the “T” shape in the inflator harness connector with the T-shaped inflator connector, then press the connector into place.

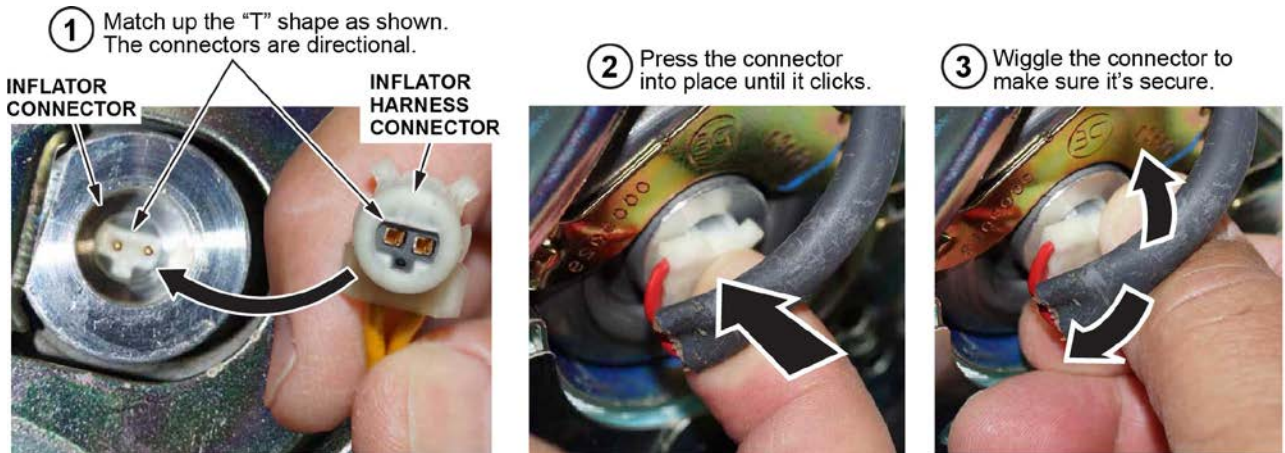

- After you hear each connector click, wiggle it to make sure it is secure.

NOTE: If the connector is not properly aligned, it will come out.

17. Connect the harness to the inflator brackets.

- Insert the side without the shrink wrap tubing first. Insert the harness at the third “valley” in the corrugated tube.
- Insert the side of the harness with the shrink wrap tubing into the inflator bracket. Make sure the harness is securely inserted and that it does not sag.

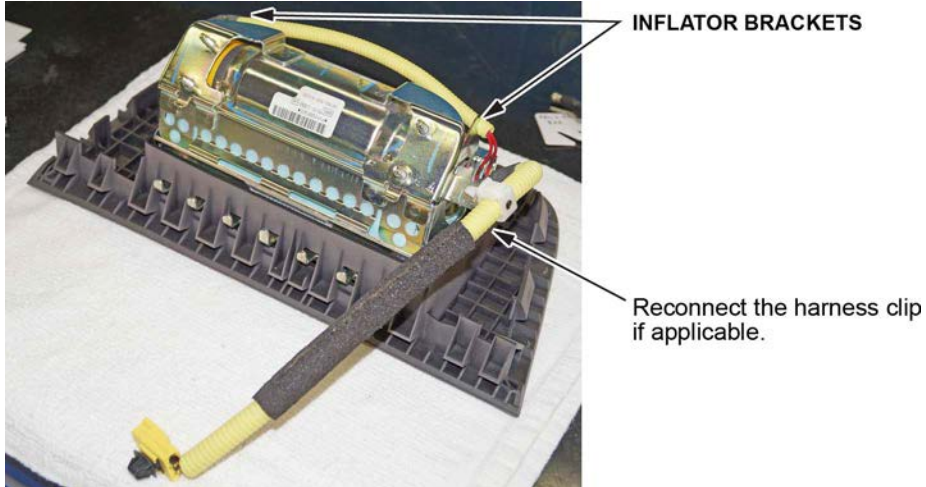

18. Reinstall the passenger’s airbag into the vehicle and torque the new locknuts to **9.8 N•m (7.2 lb-ft)**. Refer to the service repair information.

19. Reconnect the battery negative cable and enter the anti-theft code for the audio and navigation system (if applicable), then enter the audio presets.

20. Turn the ignition to the ON (II) position and make sure the SRS indicator comes on for about 6 seconds, then turns off.

21. Do the idle learn procedure (2001–05 Civic).

- Make sure all electrical items (A/C, audio unit, defogger, lights, etc.) are turned off, then start the engine.
- Let the engine reach its normal operating temperature (the cooling fans cycle twice; the coolant temperature is about 194° F).
- Let the engine idle for at least 5 minutes with the throttle fully closed and with all electrical items turned off.
- If the cooling fans cycle on while doing an idle learn, add the time the cooling fans are on to the 5 minute idle learn time.

22. Put the original inflator into the box the new one came in. Make sure there is no other hardware in the box because if the package rattles, it will not be accepted by the courier.

23. Follow the shipping instructions outlined in PIB A15-0002 to return the undeployed inflator.

24. Give your warranty clerk the RO that includes the replacement inflator serial number and replacement part number. For the warranty claim to be paid, the **replacement inflator part number** must be included in the warranty claim.

END