

IMPORTANT INFORMATION

Please inform and provide a copy of this document to every person in your dealership with campaign-related responsibilities, including Service, Parts and Accounting personnel. By law, dealers must correct, prior to delivery for sale or lease, any vehicle that fails to comply with an applicable Federal Motor Vehicle Safety Standard or that contains a defect relating to motor vehicle safety. **If you have questions regarding this or any other campaign, please contact Warranty.**



Safety Recall

Code: 24BL

**Subject: 2014-2015 MY Jetta, Beetle, Beetle Convertible, Passat
2015 MY Golf/GTI
Fuel Rail Leak**

January 22, 2015

IMPORTANT INFORMATION

Safety recall 24BL replaces safety recall 24Bi.

Under safety recall 24BL, fuel rail replacement is required for all affected vehicles.

Safety recall 24BL includes vehicles that were part of safety recall 24Bi plus some additional vehicles.

Problem Description

During engine operation, a sealing cap at the fuel rail may fail to seal, allowing fuel to leak into the engine compartment. Leaking fuel, in the presence of an ignition source, may result in a fire.

Corrective Action

Replace the fuel rail.

Affected Vehicles

U.S.A. and CANADA:

**2014-2015 Jetta, Beetle, Beetle Convertible, Passat
2015 Golf/GTI**

Verify the open Campaigns/Actions screen in Elsa to determine if the VIN# applies to this Campaign/Action

NOTE:

- *Elsa is the only valid campaign inquiry/verification source. Check Elsa on the day the campaign work will be performed to verify vehicle eligibility for the repair in order to receive claim payment consideration. Campaign status must show "open".*
- *If this repair appears to have already been performed on the vehicle but the code still shows open in Elsa, contact Warranty before proceeding further, e.g. a dealer may have recently performed this repair but not yet entered a claim for it in the system.*
- *Elsa may also show additional open action(s); if so, inform your customer - this work can be done while the vehicle is in for this campaign.*
- *Contact Warranty if you have any questions.*

Inventory Vehicle Open Campaign/Action Report (VIM)

On or about January 22, 2015, affected vehicles will be listed on the Inventory Vehicle Open Campaign Action report under My Dealership Reports (found on www.vw.com & VIM). A list will not be posted for dealers who do not have any affected vehicles.

Parts Information and Allocation

Previous allocations took place under 24Bi recall; Additional allocations will be made prior to 24BL launch. If you have exhausted your allocated parts but have exceeded your weekly Upper Order Limit, please submit your requests for additional parts via email to upperorderlimits@vw.com.

If additional parts are required for critical cases, please contact the Parts Specialists at 800-767-6552.

Owner Notification Mailing

The customer mailing will take place shortly after launch. A sample copy of the owner letter is enclosed.

Campaign Completion Labeling Guidelines

Vehicles repaired under this action must be identified with a campaign completion label (part number CAMP 010 000). Labels can be ordered at no cost online via the Compliance Label Ordering portal at www.vw.com.

Important Reminder on Vehicles Affected by Safety and Compliance Recalls

By law, dealers must correct, prior to delivery for sale or lease, any vehicle that fails to comply with an applicable Federal/Canadian Motor Vehicle Safety Standard or that contains a defect relating to motor vehicle safety.

Claim Entry Procedure

Immediately upon completion of the repair work, enter the Applicable Criteria ID and Repair Operation from the following chart. **The Applicable Criteria ID is shown in Elsa.** Claims will only be paid for vehicles that show this campaign open in Elsa on the day of the repair. To help ensure prompt and proper payment, attach the screen print to the repair order.

Saga Claim Entry Procedure

Check Elsa to determine if this campaign is open.

Service No.: 24BL
Damage Code: 0099

Parts Manufacturer

Removed part: Use vendor code **WVO**

Sold vehicle = 7 10

Unsold vehicle = 7 90

Accounting Instructions

Criteria I.D. 01

Replace Fuel Rail.

Repair operation: 2417 55 99 270 T.U.

<u>Quantity</u>	<u>Part Number</u>	<u>Part Description</u>
1	06K 133 317H	Fuel Rail*
1	06K 127 065B	Adapter
4	06J 998 907B	Injector Seal Kit
2	N 909 377 02	Tie Wrap

***Causal Indicator: Select fuel rail as causal part**

There is NO reimbursement for Vehicle Wash or Loaner

If customer refused repairs

U.S. dealers: Submit the request through WISE under the Campaigns/Update/Recall Closure option.

Canadian dealers: Fax the Repair Order to Warranty at (905) 428-4811 and provide VIN, applicable Service Number, Customer Information, Dealer Number and Date.

The repair information in this document is intended for use only by skilled technicians who have the proper tools, equipment and training to correctly and safely maintain your vehicle. These procedures are not intended to be attempted by "do-it-yourselfers," and you should not assume this document applies to your vehicle, or that your vehicle has the condition described. To determine whether this information applies, contact an authorized Volkswagen dealer. ©2015 Volkswagen Group of America, Inc. and Volkswagen Canada. All Rights Reserved.

Customer Letter Example (USA)

This notice applies to your vehicle: <VIN>

**Subject: Safety Recall 24BL – Fuel Rail Leak
Certain 2014-2015 MY Jetta, Beetle, Beetle Convertible, Passat and 2015 MY Golf/GTI**

Dear Volkswagen Owner,

This notice is sent to you in accordance with the requirements of the National Traffic and Motor Vehicle Safety Act. Volkswagen has decided that a defect, which relates to motor vehicle safety, exists in certain 2014-2015 model year Volkswagen vehicles. Our records show that you are the owner of a vehicle affected by this action.

- What is the issue?** During engine operation, a sealing cap at the fuel rail may fail to seal, allowing fuel to leak into the engine compartment. Leaking fuel, in the presence of an ignition source, may result in a fire.
- What will we do?** To help identify/correct this defect, your authorized Volkswagen dealer will replace the fuel rail in your vehicle. This work will take about three (3) hours to complete and will be performed for you free of charge.
- What should you do?** Please contact your authorized Volkswagen dealer without delay to schedule this recall repair. Please keep in mind that your dealer may need additional time for the preparation of the repair, as well as to accommodate their daily workshop schedule.
- Precautions you should take** Should a fuel rail leak occur, you may smell fuel in your vehicle. Additionally, if this happens, as pressure drops in the fuel rail the EPC warning light on the instrument panel may illuminate when fuel rail pressure cannot be maintained. If you can smell fuel in your vehicle, or if the EPC warning light comes on, proceed immediately to the nearest authorized Volkswagen dealer or qualified workshop if you believe that it is safe to do so in order to have the fuel system on the vehicle inspected.
- Lease vehicles and address changes** If you are the lessor and registered owner of the vehicle identified in this action, the law requires you to forward this letter immediately via first-class mail to the lessee within ten (10) days of receipt. If you have changed your address or sold the vehicle, please fill out the enclosed prepaid Owner Reply card and mail it to us so we can update our records.
- Reimbursement of Expenses** If you have previously paid for repairs relating to the condition described in this letter, the enclosed form explains how to request reimbursement. We would be pleased to review your reimbursement request.
- Can we assist you further?** If your authorized Volkswagen dealer fails or is unable to complete this work free of charge within a reasonable time, please call or write to:
- Volkswagen of America, Inc.,
Attn: Customer CARE (24BL)
3800 Hamlin Road, Auburn Hills, MI 48326
1-800-893-5298
www.vw.com
- Checking your vehicle for open Recalls and Service Campaigns** To check your vehicle's eligibility for repair under this or any other recall/service campaign, please visit the **Recall/Service Campaign Lookup** tool at www.vw.com and enter your Vehicle Identification Number (VIN). As always, if you have any questions or if you need additional assistance, please contact Customer CARE or your authorized Volkswagen dealer.

If you still cannot obtain satisfaction, you may file a complaint with: The Administrator, National Highway Traffic Safety Administration, 1200 New Jersey Avenue, SE., Washington, DC 20590; or call the toll-free Vehicle Safety Hotline at 1-888-327-4236 (TTY: 1-800-424-9153); or go to <http://www.safercar.gov>.

We apologize for any inconvenience this matter may cause; however we are taking this action to help ensure your safety and continued satisfaction with your vehicle. Thank you for driving a Volkswagen!

Sincerely,

Volkswagen Customer Protection

Customer Letter Example (CANADA)

<MONTH YEAR>

<CUSTOMER NAME>

<CUSTOMER ADDRESS>

<CUSTOMER CITY STATE ZIPCODE>

This notice applies to your vehicle: <VIN>

**Subject: Safety Recall 24BL – Fuel Rail Leak
Certain 2014-2015 MY Jetta, Beetle, Beetle Convertible, Passat and 2015 MY Golf/GTI**

Dear Volkswagen Owner,

This notice is sent to you in accordance with the requirements of the Motor Vehicle Safety Act. Volkswagen has decided that a defect, which relates to motor vehicle safety, exists in certain 2014-2015 model year Volkswagen vehicles. Our records show that you are the owner of a vehicle affected by this action.

What is the issue? During engine operation, a sealing cap at the fuel rail may fail to seal, allowing fuel to leak into the engine compartment. Leaking fuel, in the presence of an ignition source, may result in a fire.

What will we do? To help identify/correct this defect, your authorized Volkswagen dealer will replace the fuel rail in your vehicle. This work will take about three (3) hours to complete and will be performed for you free of charge.

What should you do? Please contact your authorized Volkswagen dealer without delay to schedule this recall repair. Please keep in mind that your dealer may need additional time for the preparation of the repair, as well as to accommodate their daily workshop schedule.

Lease vehicles and address changes If you are the lessor and registered owner of the vehicle identified in this action, the law requires you to forward this letter immediately via first-class mail to the lessee within ten (10) days of receipt. If you have changed your address or sold the vehicle, please fill out the enclosed prepaid Owner Reply card and mail it to us so we can update our records.

Reimbursement of Expenses If you have previously paid for repairs relating to the condition described in this letter, the enclosed form explains how to request reimbursement. We would be pleased to review your reimbursement request.

Can we assist you further? If your authorized Volkswagen dealer fails or is unable to complete this work free of charge within a reasonable time, please call or write to:

Volkswagen Canada
Attn: Customer Relations (24BL)
PO Box 842, Stn. A
Windsor, ON N9A 6P2
1-800-822-8987
www.vw.ca

We apologize for any inconvenience this matter may cause; however we are taking this action to help ensure your safety and continued satisfaction with your vehicle. Thank you for driving a Volkswagen!

Sincerely,

Volkswagen Customer Protection

Required Tools:

	<ul style="list-style-type: none">• VAG1783 – Torque Wrench 2-10Nm (or equivalent)
	<ul style="list-style-type: none">• VAS6362 – Hose Clip Pliers (or equivalent)
	<ul style="list-style-type: none">• T10118 – Elbow Assembly Tool (or equivalent)
	<ul style="list-style-type: none">• T10456 – 17mm Flare Nut Attachment

Required Parts:

<u>Quantity</u>	<u>Part Number</u>	<u>Part Description</u>
1	06K 133 317H	Fuel Rail
1	06K 127 065B	Adapter
4	06J 998 907B	Injector Seal Kit
2	N 909 377 02	Tie Wrap

Work Procedure



Tip: If Campaign Completion label for **recall code 24BL** is present, no further work required.

Applicable Criteria ID (s)	Campaign/Action Status
01	Open

EXAMPLE

Section A – Check for Previous Repair

- Enter the VIN in Elsa and proceed to the “Campaign/Action” screen



Tip: On the date of repair, print this screen and keep a copy with the repair order

- ⇐ Ensure that the Status is “Open”
<arrow 2>
- ⇐ Note the Applicable Criteria ID
<arrow 1> for use in determining the correct work to be done and corresponding parts associated

- **Proceed to Section B.**

Section B – Fuel Rail Replacement

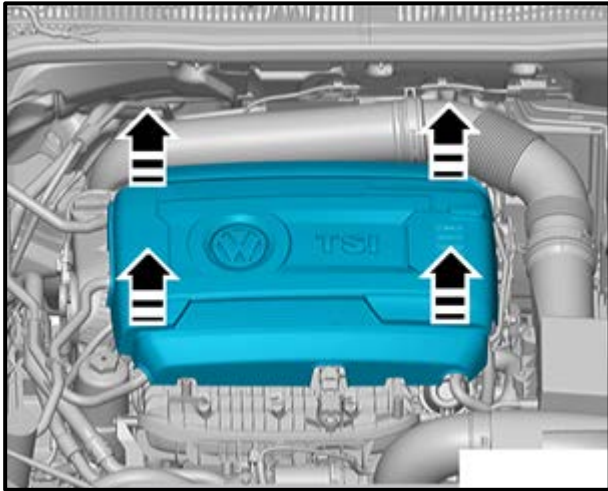

- Open the hood.
 - Open/remove the battery cover.
 - Disconnect and isolate the negative battery cable.
- ⇐ Lift and remove the engine cover as shown <direction of arrows>.

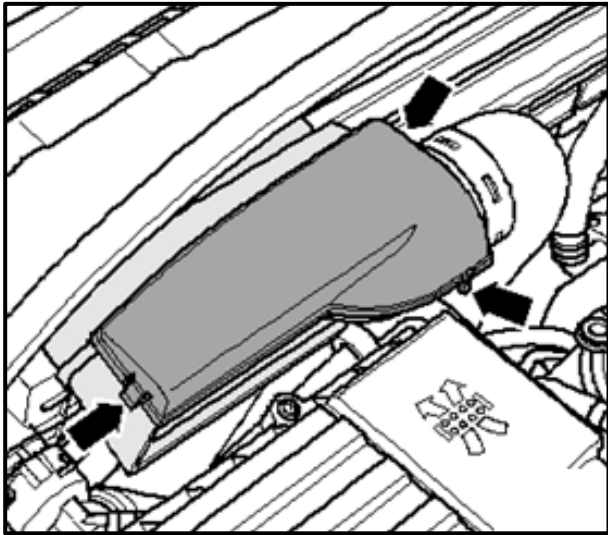

- ⇐ Disengage the clips <arrows> and remove the air guide cover.

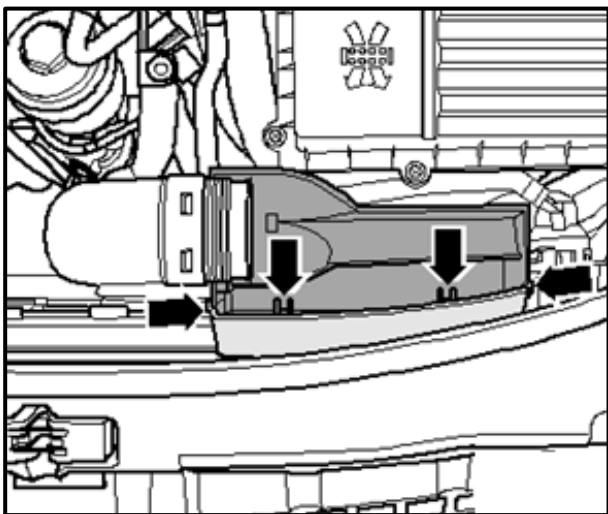

- ⇐ Release the clips <arrows> and unfasten the lower air guide.

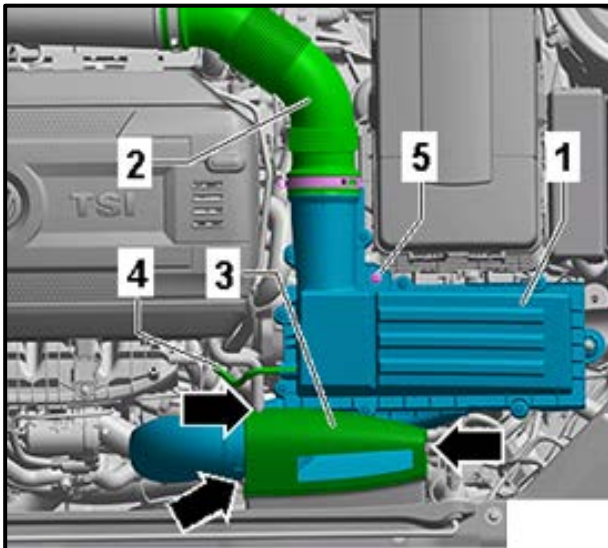

- ⇐ Remove the air guide hose <2>.
- ⇐ Disconnect the vacuum hose <4> from the air filter housing.

On vehicles with secondary air injection:

- ⇐ Remove the secondary air line connection <5> from the air filter housing.
- ⇐ Loosen the mounting bolt <5> and lift upward on the air filter housing <1> to remove it.

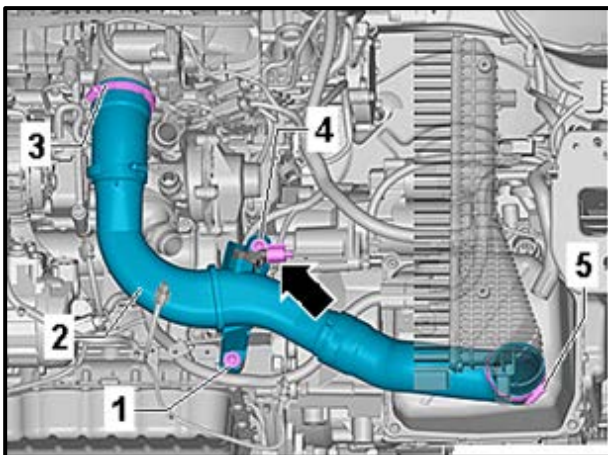

- ⇐ Loosen clamps <3 and 5>.
- ⇐ Disconnect the Charge Air Pressure Sensor G31 <arrow>.
- ⇐ Remove bolts <1 and 4>.
- ⇐ Remove the air guide pipe <2>.



- ⇐ Remove the mounting bolts <arrows> for the coolant line from the intake manifold.

! Note: During this procedure, it is NOT necessary to open the cooling system.

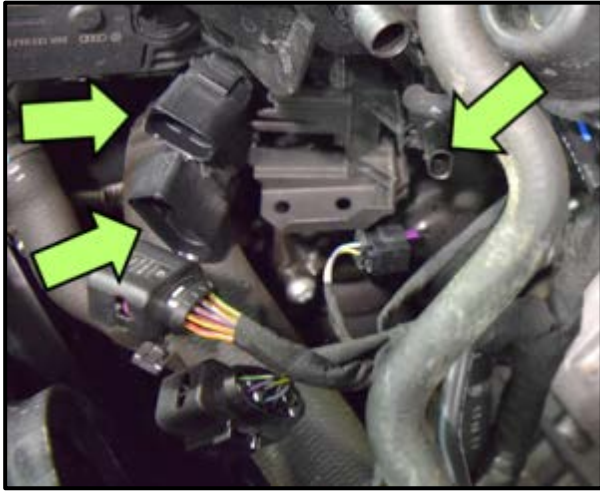

⇐ Disconnect the wiring harness connectors <arrows> underneath the intake manifold.

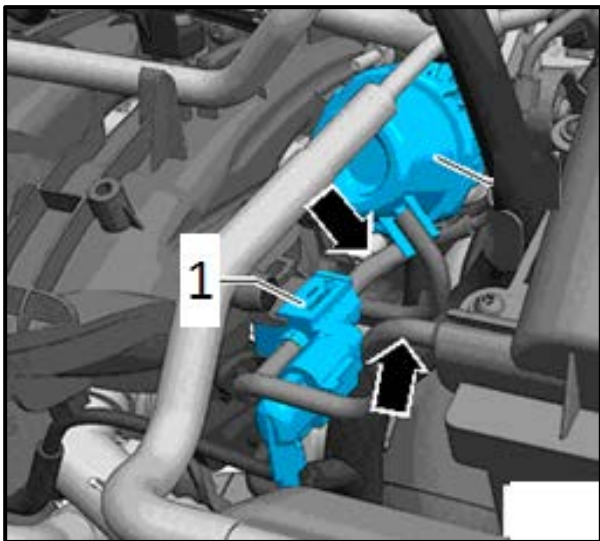

⇐ Disconnect the connector from the Intake Manifold Runner Control Valve (IMRC) N316 <1>.

⇐ Disconnect the vacuum line <top arrow> from the IMRC N316 <1>.

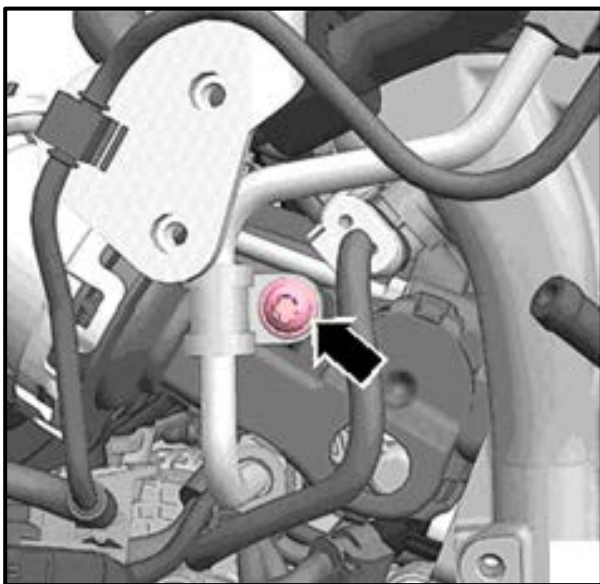

⇐ Remove the screw <arrow> from the mounting clamp.

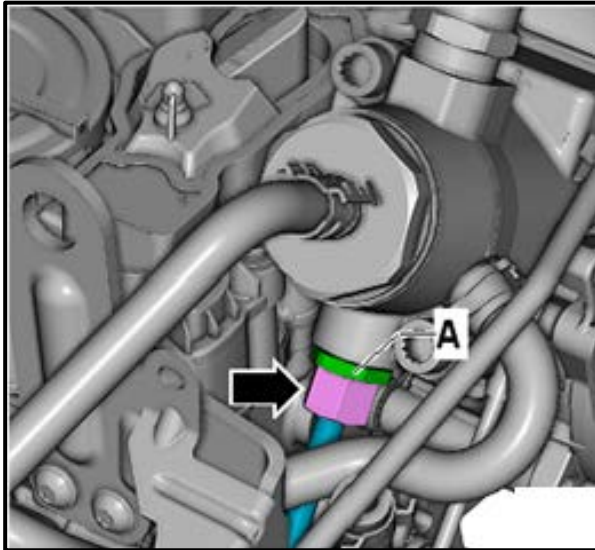

WARNING:

The fuel system is under pressure. Use caution during disassembly. Wear safety glasses and protective gloves.

- ⇐ Wrap the fitting area <arrow> with a clean cloth.
- ⇐ Hold the adapter <A> stationary, and carefully loosen the union nut <arrow>.
- Allow any residual fuel pressure to bleed off slowly before fully removing the nut.



Tip: It is not necessary to remove the flare nut <A> during this procedure. Only loosen the nut to allow the fuel line to be moved aside during removal of the fuel rail.



CAUTION: DO NOT allow the adapter <A> to turn while loosening the union nut <arrow>. If the adapter loosens from the high pressure fuel pump during disassembly the adapter MUST be replaced.

- ⇐ Loosen the union nut on the fuel rail <arrow> with the Flare Nut Attachment 17mm – T10456 and remove the high pressure line <as shown>.



Note: Clean up any residual fuel before proceeding.

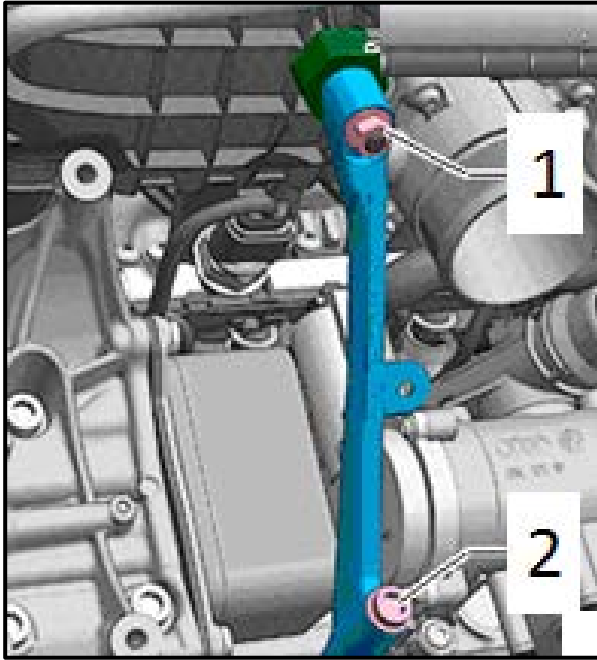

- Raise the vehicle on an appropriate hoist.
- Remove the underbody shield.
- ⇐ Remove the nut <1> and the bolt <2> from the intake manifold support.
- Remove the intake manifold support.

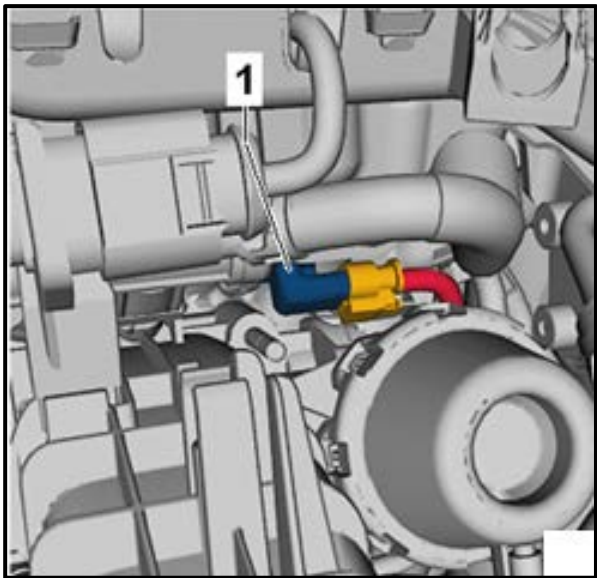

- ⇐ Disconnect the Camshaft Position Sensor G40 connector <1>.



- Loosen and remove the oil filter.

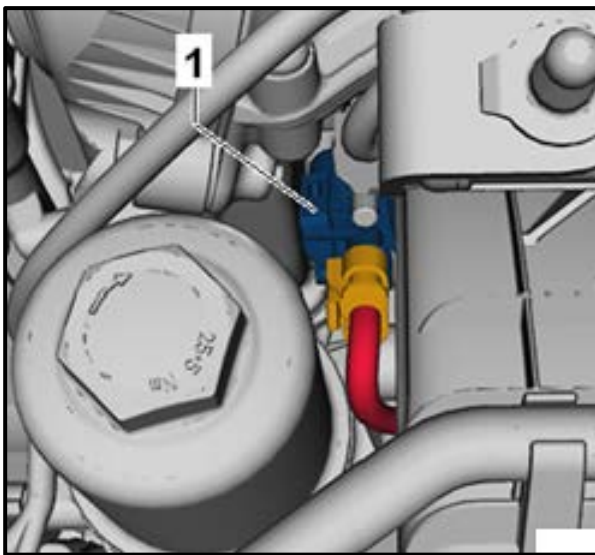

- ⇐ Disconnect the IMRC position sensor G336 <1>.

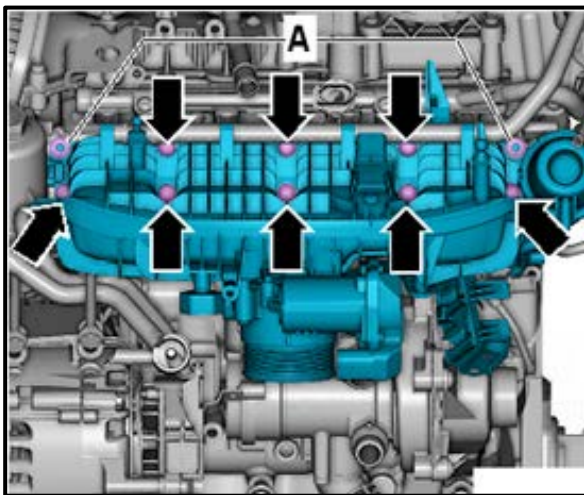

- ⇐ Remove the mounting nuts <A> and the mounting bolts <arrows> from the intake manifold.

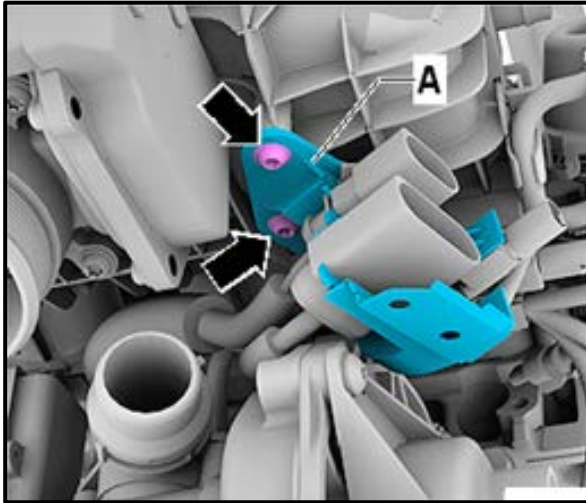

- ⇐ Pull the intake manifold slightly away from the cylinder head and remove the bolts <arrows> from the bracket <A>.
- Release the vacuum line from the intake manifold.
- Remove the intake manifold.

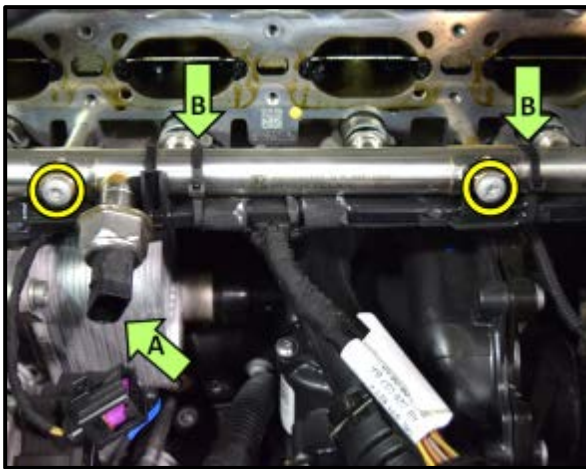

- ⇐ Disconnect the fuel rail pressure sensor G247 <arrow A>.
- ⇐ If present, cut and remove the tie wraps <arrows B>.
- Release the wiring harness retaining clips from the fuel rail.
- ⇐ Remove the mounting bolts <circles> from the fuel rail.
- Remove the fuel rail from the cylinder head.

! Note: While removing the fuel rail, hold the injectors in place. If any injector comes out of the cylinder head during fuel rail removal, ALL seals on that injector MUST be replaced.

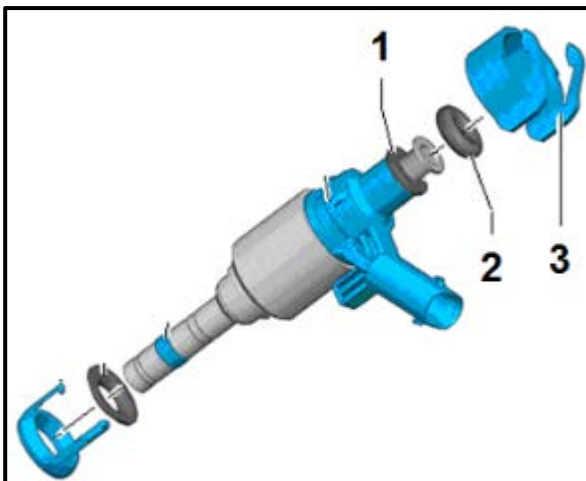

- ⇐ Using the appropriate seals from injector seal kit, P/N 06J998907B, replace the upper seals <1 and 2> and the metal retainer <3> on each fuel injector.

i Tip: Not all the seals in each kit are used for this repair.



⇐ Lubricate the upper o-ring on each fuel injector with clean engine oil <as shown>.

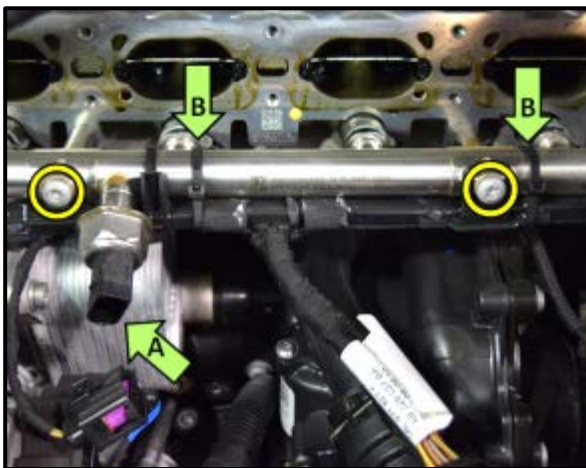

- Install the replacement fuel rail, P/N 06K133317H.
- ⇐ Torque the mounting screws <circles> to 9 Nm.
- Refasten the wiring harness retaining clips onto the fuel rail.
 - Reinstall the fuel rail pressure sensor and torque to 27 Nm.
- ⇐ Reconnect the fuel rail pressure sensor G247 <arrow A>.
- ⇐ Install replacement tie wraps, P/N N90937702 around the wiring harness and fuel rail where shown <arrows B>.



⇐ Install the new fuel line adapter <arrow>, P/N 06K127065B, into the end of the fuel rail and torque to 40Nm.

 Note: It is not necessary to apply any sealant to the fuel rail, lines, or other fuel system fittings during this repair.

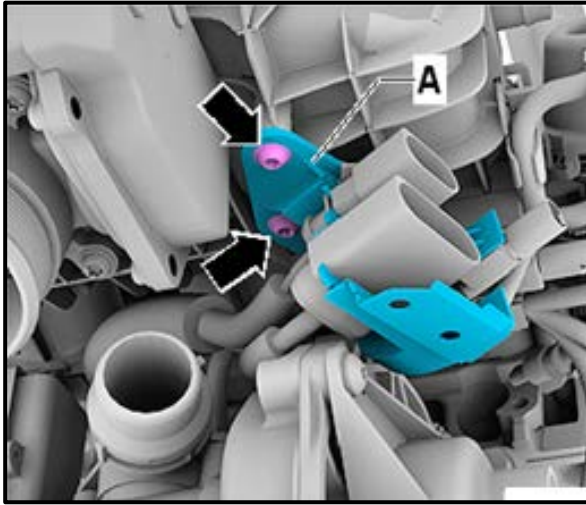

- Place the intake manifold back into position.
- ⇐ Reinstall the mounting bolts <arrows> into the bracket <A>.
- Reconnect the vacuum line to the intake manifold.

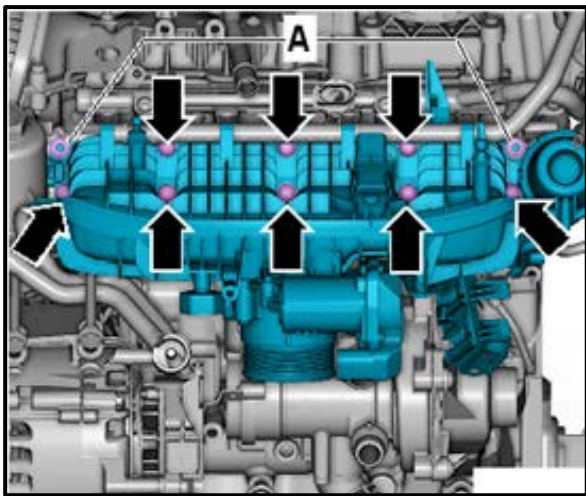

- ⇐ Reinstall all the intake manifold mounting nuts <A> and mounting bolts <arrows>.
- Torque all fasteners to 9Nm.

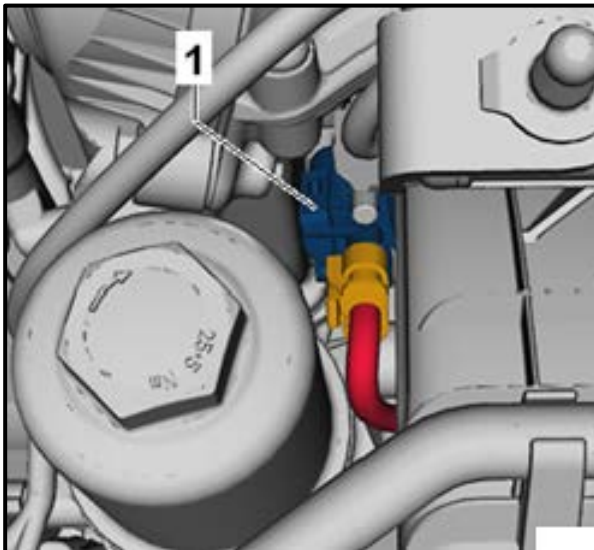

- ⇐ Reconnect the IMRC position sensor G336 <1>.



← Reinstall the oil filter.

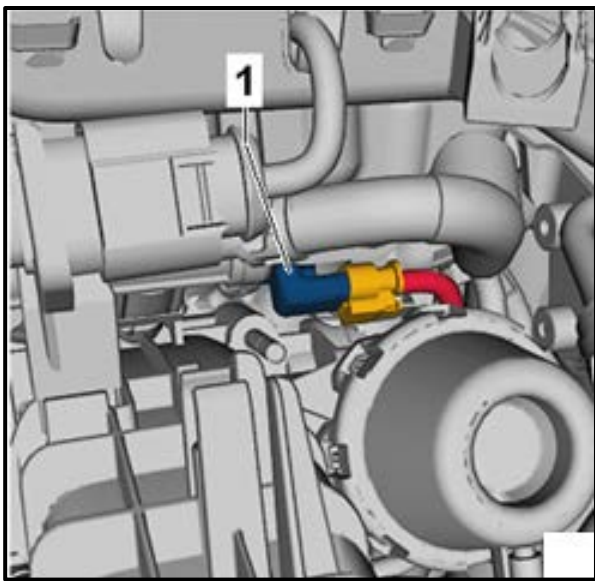

← Reconnect the camshaft position sensor G40 <1>.

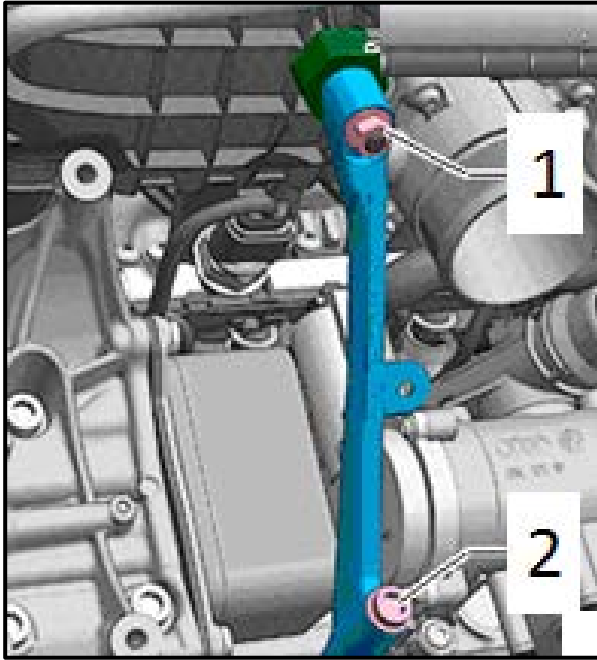

- Reinstall the intake manifold support.
- ⇐ Install and tighten the mounting nut <1> and bolt <2>.

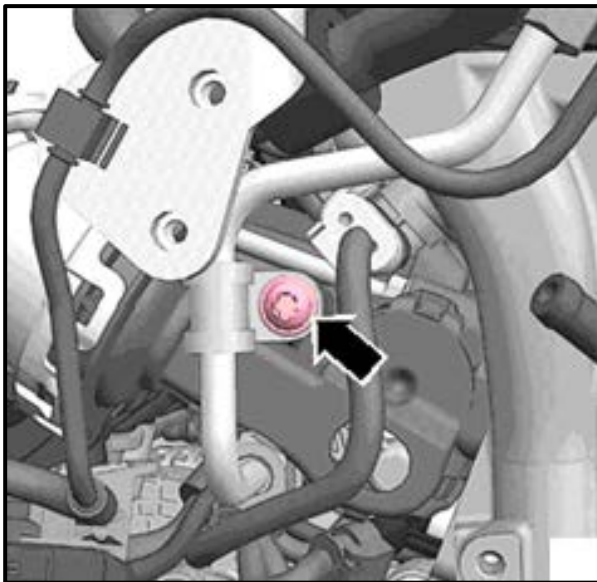

- Lubricate each end of the fuel line with clean engine oil (or equivalent).
 - Reinstall the fuel line between high pressure pump and the fuel rail.
 - Install the end nuts by hand.
- ⇐ Reinstall the fuel line mounting clamp and bolt <arrow>.



- ⇐ Using an appropriate torque wrench and the flare nut attachment T10456 <as shown>, torque the flare nut onto the fuel rail adapter at 27Nm.

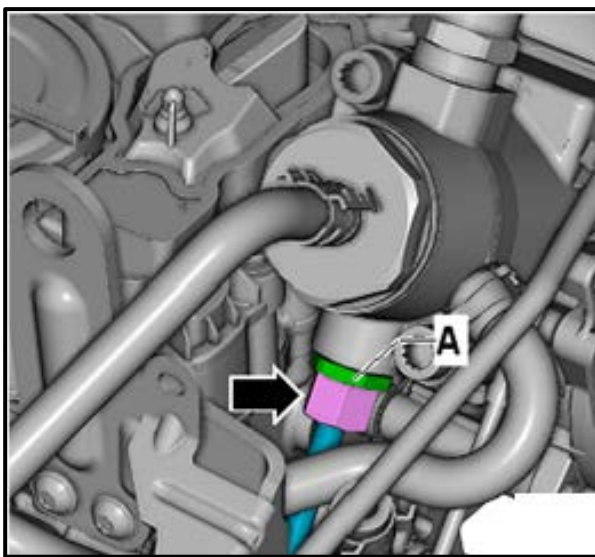

- ⇐ Using an appropriate torque wrench and crow's foot fitting, torque the flare nut <arrow> onto the high pressure pump adapter at 27Nm.

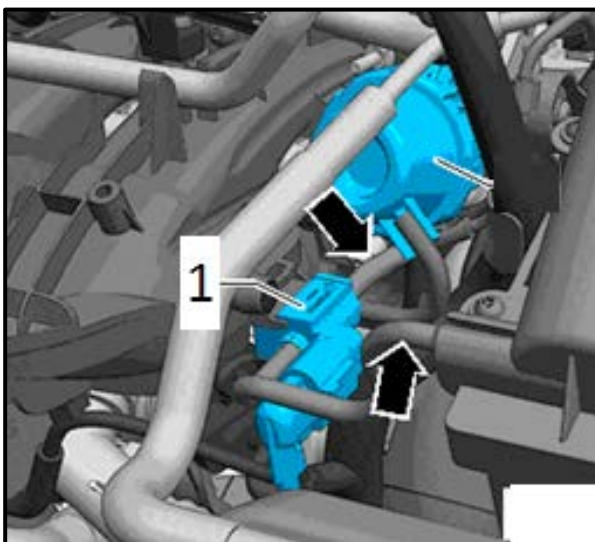

- ⇐ Reconnect the IMRC N316 connector <1>.
- ⇐ Reconnect the vacuum line <top arrow> to the IMRC N316 <1>.

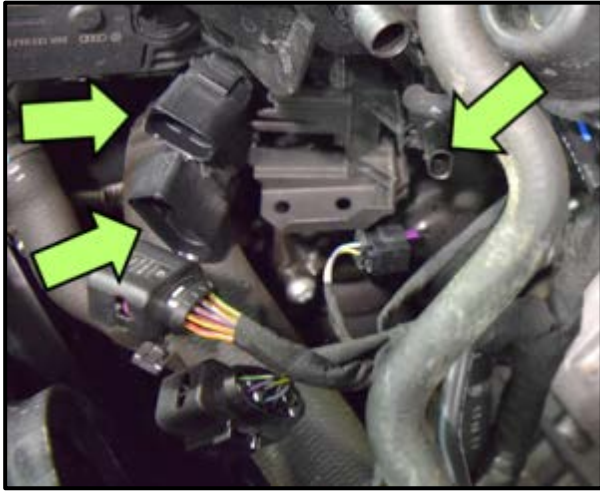

⇐ Reconnect the wiring harness connectors <arrows> underneath the intake manifold.



⇐ Reinstall the coolant hose mounting bolts <arrows>.

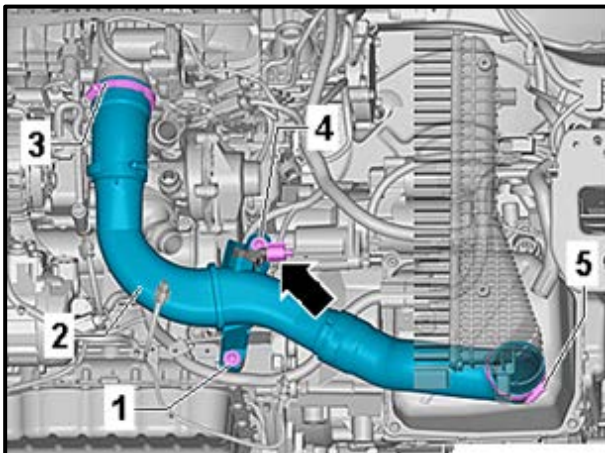

- ⇐ Reinstall the air guide pipe <2>.
- ⇐ Tighten the bolts <1 and 4>.
- ⇐ Reconnect the Charge Air Pressure Sensor G31 <arrow>.
- ⇐ Tighten the clamps <3 and 5>.

- Reinstall the air filter housing and intake tube.
- Reconnect the battery.
- Reinstall/close the battery cover.
- Clean any remaining residual fuel from the engine compartment.
- Start the engine and inspect the fuel rail, lines, and fittings for leaks.
- Shut the engine off.
- Reinstall the engine cover.
- Close the hood.
- Clear all DTC's.
- Reset customer convenience features (i.e. one touch windows, clock).

Work Complete – Proceed to Section C

Section C – Campaign Completion Label and Parts Return/Disposal

Install Campaign Completion Label

- Open the hood.
- ⇐ Fill out and affix Campaign Completion label, part number CAMP 010 000, next to the vehicle emission control information label



Tip: Ensure Campaign Completion label does not cover any existing label(s)

- Close the hood.

Parts Return/Disposal

Properly destroy or dispose of removed parts in accordance with all state and local requirements, unless otherwise indicated and/or requested through the Warranty Parts Shipping Portal (WPSP) for U.S. and SAGA for Canada.

ALL WORK IS COMPLETE